

## TPS7A20 300 mA、超低噪声、低 $I_Q$ 、高 PSRR LDO

### 1 特性

- 低输出电压噪声：7  $\mu V_{RMS}$ 
  - 无需噪声旁路电容
- 高 PSRR：1 kHz 时为 95 dB
- 超低  $I_Q$ ：6.5  $\mu A$
- 输入电压范围：1.6V 至 6.0V
- 输出电压范围：0.8V 至 5.5V
- 输出电压容差： $\pm 1.5\%$  (最大值)
- 超低压降：
  - 在 300 mA 下为 140 mV (最大值) ( $V_{OUT} = 3.3V$ )
  - 在 300 mA 下为 145 mV (最大值) ( $V_{OUT} = 3.3V$ , DBV)
- 低浪涌电流
- 智能使能端下拉
- 与最低 1  $\mu F$  的陶瓷输出电容搭配使用可保持稳定
- 封装：
  - 1mm  $\times$  1mm X2SON
  - 0.616mm  $\times$  0.616mm DSBGA
  - 2.90mm  $\times$  1.60mm SOT23-5

### 2 应用

- 智能手机和平板电脑
- IP 网络摄像头
- 便携式医疗设备
- 智能仪表和现场变送器
- 电机驱动器
- 可穿戴设备

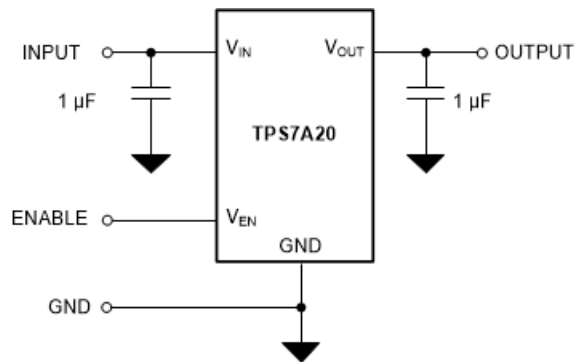

简化版原理图

### 3 说明

TPS7A20 是一款超小型低压降 (LDO) 线性稳压器，可提供 300 mA 的输出电流。TPS7A20 旨在提供符合射频和其他敏感模拟电路要求的低噪声、高 PSRR 和出色的负载和线路瞬态性能。TPS7A20 采用创新的设计技术，无需噪声旁路电容便可提供超低的噪声性能。TPS7A20 的优点还在于具有低静态电流，适用于任何电池供电的应用。TPS7A20 具有 1.6V 至 6.0V 的输入电压范围和 0.8V 至 5.5 V 的输出电压范围，可用于各种应用。该器件使用精密基准电路，可在不同负载、线路和温度变化之间提供 1.5% 的最大精度。

TPS7A20 具备内部软启动功能，旨在降低浪涌电流，因此可在启动过程中最大限度地降低输入电压降。该器件在与小型陶瓷电容搭配使用时可保持稳定，因此可实现小尺寸总体解决方案。

TPS7A20 具有带内部控制下拉电阻的智能使能输入电路，该电阻即使在 EN 引脚悬空时也能让 LDO 保持禁用状态，因而无需使用外部组件来下拉 EN 引脚。

#### 器件信息<sup>(1)</sup>

| 器件型号    | 封装         | 封装尺寸 (标称值)                 |
|---------|------------|----------------------------|
| TPS7A20 | X2SON (4)  | 1.00mm $\times$ 1.00mm     |
|         | DSBGA (4)  | 0.616 mm $\times$ 0.616 mm |
|         | SOT-23 (5) | 2.90mm $\times$ 1.60mm     |

(1) 如需了解所有可用封装，请参阅数据表末尾的可订购产品附录。



## Table of Contents

|  |           |  |           |
|--|-----------|--|-----------|
| <b>1 特性</b> .....                              | <b>1</b>  | <b>8 Application and Implementation</b> .....                    | <b>27</b> |
| <b>2 应用</b> .....                              | <b>1</b>  | 8.1 Application Information.....                                 | 27        |
| <b>3 说明</b> .....                              | <b>1</b>  | 8.2 Typical Application.....                                     | 30        |
| <b>4 Revision History</b> .....                | <b>2</b>  | <b>9 Power Supply Recommendations</b> .....                      | <b>31</b> |
| <b>5 Pin Configuration and Functions</b> ..... | <b>3</b>  | <b>10 Layout</b> .....   | <b>32</b> |
| <b>6 Specifications</b> .....                  | <b>5</b>  | 10.1 Layout Guidelines.....                                      | 32        |
| 6.1 Absolute Maximum Ratings.....              | 5         | 10.2 Layout Examples.....  | 32        |
| 6.2 ESD Ratings.....                           | 5         | <b>11 Device and Documentation Support</b> .....                 | <b>33</b> |
| 6.3 Recommended Operating Conditions.....      | 5         | 11.1 Device Support.....   | 33        |
| 6.4 Thermal Information.....                   | 6         | 11.2 接收文档更新通知.....   | 33        |
| 6.5 Electrical Characteristics.....            | 6         | 11.3 支持资源.....   | 33        |
| 6.6 Switching Characteristics.....             | 7         | 11.4 Trademarks.....   | 33        |
| 6.7 Typical Characteristics.....               | 8         | 11.5 Electrostatic Discharge Caution.....                        | 33        |
| <b>7 Detailed Description</b> .....            | <b>23</b> | 11.6 术语表.....  | 33        |
| 7.1 Overview.....                              | 23        | <b>12 Mechanical, Packaging, and Orderable Information</b> ..... | <b>33</b> |
| 7.2 Functional Block Diagram.....              | 23        | 12.1 Mechanical Data.....  | 34        |
| 7.3 Feature Description.....                   | 24        |  |           |
| 7.4 Device Functional Modes.....               | 26        |  |           |

## 4 Revision History

注：以前版本的页码可能与当前版本的页码不同

| <b>Changes from Revision F (April 2022) to Revision G (May 2022)</b>          | <b>Page</b> |
|---|-------------|
| • Changed UVLO condition from rising to falling for YCJ and YCK packages..... | 6           |

---

| <b>Changes from Revision E (December 2021) to Revision F (April 2022)</b> | <b>Page</b> |
|---|-------------|
| • 将 DSBGA 尺寸从 0.603mm × 0.603mm 更改为 0.616mm × 0.616mm (位于特性和说明部分).....    | 1           |

## 5 Pin Configuration and Functions



图 5-1. YCJ and YCK Packages, 4-Pin DSBGA (Top View)



图 5-2. YCJ and YCK Packages, 4-Pin DSBGA (Bottom View)

### Pin Functions: DSBGA

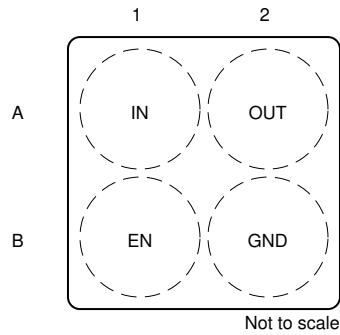
| PIN |      | I/O | DESCRIPTION  |
|-----|------|-----|--|
| NO. | NAME |     |  |
| A1  | IN   | I   | Input voltage supply. For best transient response and to minimize input impedance, use the nominal value or larger capacitor from IN to ground as listed in the <i>Recommended Operating Conditions</i> table. Place the input capacitor as close to the IN and GND pins of the device as possible.  |
| A2  | OUT  | O   | Regulated output voltage. A low equivalent series resistance (ESR) capacitor is required from OUT to ground for stability. For best transient response, use the nominal recommended value or larger capacitor listed in the <i>Recommended Operating Conditions</i> table. Place the output capacitor as close to the OUT and GND pins of the device as possible. An internal 150- $\Omega$ (typical) pulldown resistor prevents a charge from remaining on $V_{OUT}$ when the regulator is in shutdown mode ( $V_{EN} < V_{EN(Low)}$ ). |
| B1  | EN   | I   | Enable input. A low voltage ( $< V_{EN(Low)}$ ) on this input turns the regulator off and discharges the output pin to GND. A high voltage ( $> V_{EN(Hi)}$ ) on this pin enables the regulator output. This pin has an internal 500-k $\Omega$ pulldown resistor to hold the regulator off by default. When $V_{EN} > V_{EN(Hi)}$ , the 500-k $\Omega$ pulldown is disconnected to reduce input current.  |
| B2  | GND  | —   | Common ground.   |

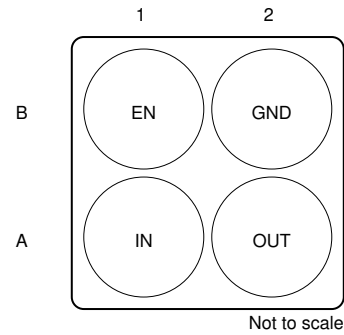

图 5-3. DQN Package, 4-Pin X2SON (Top View)



图 5-4. DBV Package, 5-Pin SOT-23 (Top View)

**Pin Functions: X2SON, SOT-23**

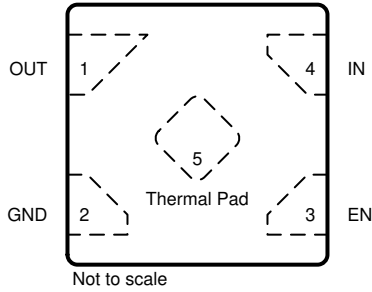
| NAME        | PIN   |        | I/O | DESCRIPTION  |
|-------------|-------|--------|-----|--|
|             | X2SON | SOT-23 |     |  |
| IN          | 4     | 1      | I   | Input voltage supply. For best transient response and to minimize input impedance, use the nominal value or larger capacitor from IN to ground as listed in the <i>Recommended Operating Conditions</i> table. Place the input capacitor as close to the IN and GND pins of the device as possible.  |
| OUT         | 1     | 5      | O   | Regulated output voltage. A low equivalent series resistance (ESR) capacitor is required from OUT to ground for stability. For best transient response, use the nominal recommended value or larger capacitor listed in the <i>Recommended Operating Conditions</i> table. Place the output capacitor as close to the OUT and GND pins of the device as possible. An internal 150- $\Omega$ (typical) pulldown resistor prevents a charge from remaining on $V_{OUT}$ when the regulator is in shutdown mode ( $V_{EN} < V_{EN(Low)}$ ). |
| EN          | 3     | 3      | I   | Enable input. A low voltage ( $< V_{EN(Low)}$ ) on this pin turns the regulator off and discharges the output pin to GND. A high voltage ( $> V_{EN(Hi)}$ ) on this pin enables the regulator output. This pin has an internal 500-k $\Omega$ pulldown resistor to hold the regulator off by default. When $V_{EN} > V_{EN(Hi)}$ , the 500-k $\Omega$ pulldown is disconnected to reduce input current.  |
| GND         | 2     | 2      | —   | Common ground.   |
| N/C         | —     | 4      | —   | No internal electrical connection.   |
| Thermal Pad | 5     | —      | —   | Thermal pad for the X2SON package. Connect this pad to GND or leave floating. Do not connect to any potential other than GND. Connect the thermal pad to a large-area ground plane for best thermal performance.   |

## 6 Specifications

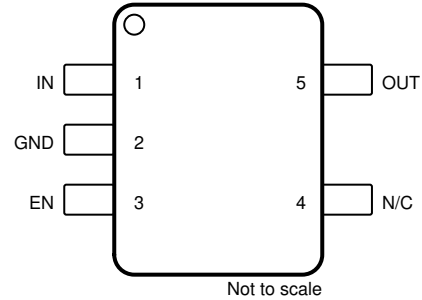
### 6.1 Absolute Maximum Ratings

over operating free-air temperature range (unless otherwise noted)<sup>(1) (3)</sup>

|             |                                    | MIN                | MAX   | UNIT |
|-------------|------------------------------------|--------------------|---|------|
| Voltage     | V <sub>IN</sub>                    | - 0.3              | 6.5   | V    |
|             | V <sub>OUT</sub>                   | - 0.3              | 6.5 or V <sub>IN</sub> + 0.3 <sup>(2)</sup> |      |
|             | V <sub>EN</sub>                    | - 0.3              | 6.5   |      |
| Current     | Maximum output <sup>(4)</sup>      | Internally limited |   | A    |
| Temperature | Operating junction, T <sub>J</sub> | - 40               | 150   | °C   |
|             | Storage, T <sub>stg</sub>          | - 65               | 150   | °C   |

- (1) Stresses beyond those listed under *Absolute Maximum Ratings* may cause permanent damage to the device. These are stress ratings only, and functional operation of the device at these or any other conditions beyond those indicated under Recommended Operating Conditions is not implied. Exposure to absolute-maximum-rated conditions for extended periods may affect device reliability.
- (2) The maximum value of V<sub>OUT</sub> is the lesser of 6.5 V or (V<sub>IN</sub> + 0.3 V).
- (3) All voltages are with respect to the GND pin.
- (4) Internal thermal shutdown circuitry protects the device from permanent damage.

### 6.2 ESD Ratings

|                    |                         |  | VALUE | UNIT |
|--------------------|-------------------------|--|-------|------|
| V <sub>(ESD)</sub> | Electrostatic discharge | Human-body model (HBM), per ANSI/ESDA/JEDEC JS-001 <sup>(1)</sup>              | ±2000 | V    |
|                    |                         | Charged-device model (CDM), per JEDEC specification JESD22-C101 <sup>(2)</sup> | ±750  |      |

- (1) JEDEC document JEP155 states that 500-V HBM allows safemanufacturing with a standard ESD control process.
- (2) JEDEC document JEP157 states that 250-V CDM allows safemanufacturing with a standard ESD control process.

### 6.3 Recommended Operating Conditions

over operating free-air temperature range (unless otherwise noted)<sup>(1)</sup>

|                  |  | MIN  | NOM | MAX | UNIT |
|------------------|--|------|-----|-----|------|
| V <sub>IN</sub>  | Input supply voltage                         | 1.6  |     | 6.0 | V    |
| V <sub>EN</sub>  | Enable input voltage                         | 0    |     | 6.0 | V    |
| V <sub>OUT</sub> | Nominal output voltage range                 | 0.8  |     | 5.5 | V    |
| I <sub>OUT</sub> | Output current                               | 0    |     | 300 | mA   |
| C <sub>IN</sub>  | Input capacitor <sup>(2)</sup>               |      | 1   |     | μF   |
| C <sub>OUT</sub> | Output capacitor <sup>(3)</sup>              | 1    |     | 200 | μF   |
| ESR              | Output capacitor effective series resistance |      |     | 100 | mΩ   |
| T <sub>J</sub>   | Operating junction temperature               | - 40 |     | 125 | °C   |

- (1) All voltages are with respect to GND.
- (2) An input capacitor is not required for LDO stability. However, an input capacitor with an effective value of 0.47 μF minimum is recommended to counteract the effect of source resistance and inductance, which may in some cases cause symptoms of system-level instability such as ringing or oscillation, especially in the presence of load transients.
- (3) Effective output capacitance of 0.47 μF minimum and 200 μF maximum is required for stability.

## 6.4 Thermal Information

| THERMAL METRIC <sup>(1)</sup> |  | TPS7A20         |                |                |                | UNIT |
|-------------------------------|--|-----------------|----------------|----------------|----------------|------|
|                               |  | DBV<br>(SOT-23) | DQN<br>(X2SON) | YCJ<br>(DSBGA) | YCK<br>(DSBGA) |      |
|                               |  | 5 PINS          | 4 PINS         | 4 PINS         | 4 PINS         |      |
| $R_{\theta JA}$               | Junction-to-ambient thermal resistance       | 187.1           | 166.1          | 199.6          | 201.4          | °C/W |
| $R_{\theta JC(top)}$          | Junction-to-case (top) thermal resistance    | 85.5            | 103.6          | 2.8            | 2.8            | °C/W |
| $R_{\theta JB}$               | Junction-to-board thermal resistance         | 54.4            | 110.6          | 67.5           | 69.3           | °C/W |
| $\psi_{JT}$                   | Junction-to-top characterization parameter   | 27.1            | 3.0            | 1.4            | 1.4            | °C/W |
| $\psi_{JB}$                   | Junction-to-board characterization parameter | 54.1            | 103.3          | 67.4           | 69.2           | °C/W |
| $R_{\theta JC(bot)}$          | Junction-to-case (bottom) thermal resistance | N/A             | 98.8           | N/A            | N/A            | °C/W |

(1) For more information about traditional and new thermal metrics, see the [Semiconductor and IC Package Thermal Metrics](#) application report.

## 6.5 Electrical Characteristics

at operating temperature range ( $T_J = -40^\circ\text{C}$  to  $+125^\circ\text{C}$ ),  $V_{IN} = V_{OUT(NOM)} + 0.3\text{ V}$  or  $1.6\text{ V}$ , whichever is greater,  $V_{EN} = 1.0\text{ V}$ ,  $I_{OUT} = 1\text{ mA}$ ,  $C_{IN} = 1\text{ }\mu\text{F}$ ,  $C_{OUT} = 1\text{ }\mu\text{F}$  (unless otherwise noted); all typical values are at  $T_J = 25^\circ\text{C}$

| PARAMETER        | TEST CONDITIONS          | MIN   | TYP   | MAX  | UNIT |               |
|------------------|--------------------------|---|---|------|------|---------------|
| $\Delta V_{OUT}$ | Output voltage tolerance | $V_{IN} = (V_{OUT(NOM)} + 0.3\text{ V})$ to $6.0\text{ V}$ ,<br>$I_{OUT} = 1\text{ mA}$ to $300\text{ mA}$ ,<br>$V_{OUT} \geq 1.85\text{ V}$ (DQN, YCJ, YCK packages) | -1.5  |      | 1.5  | %             |
|                  |                          | $V_{IN} = (V_{OUT(NOM)} + 0.3\text{ V})$ to $6.0\text{ V}$ ,<br>$I_{OUT} = 1\text{ mA}$ to $300\text{ mA}$ ,<br>$V_{OUT} \geq 2.8\text{ V}$ (DBV package)             | -1.5  |      | 1.5  |               |
|                  |                          | $V_{IN} = (V_{OUT(NOM)} + 0.5\text{ V})$ to $6.0\text{ V}$ ,<br>$I_{OUT} = 1\text{ mA}$ to $300\text{ mA}$ ,<br>$V_{OUT} < 1.85\text{ V}$ (DQN, YCJ, YCK packages)    | -30   |      | 30   | mV            |
|                  |                          | $V_{IN} = (V_{OUT(NOM)} + 0.3\text{ V})$ to $6.0\text{ V}$ ,<br>$I_{OUT} = 1\text{ mA}$ to $300\text{ mA}$ ,<br>$V_{OUT} < 2.8\text{ V}$ (DBV package)                | -40   |      | 40   |               |
| $\Delta V_{OUT}$ | Line regulation          | $V_{IN} = (V_{OUT(NOM)} + 0.3\text{ V})$ to $6.0\text{ V}$ ,<br>$I_{OUT} = 1\text{ mA}$   |   | 0.03 | %/V  |               |
| $\Delta V_{OUT}$ | Load regulation          | $I_{OUT} = 1\text{ mA}$ to $300\text{ mA}$ (DQN, YCJ, YCK packages)   |   | 13   | mV   |               |
|                  |                          | $I_{OUT} = 1\text{ mA}$ to $300\text{ mA}$ (DBV package)  |   | 19   |      |               |
| $I_{GND}$        | Quiescent ground current | $V_{EN} = V_{IN} = 6\text{ V}$ ,<br>$I_{OUT} = 0\text{ mA}$   | $T_J = 25^\circ\text{C}$                            | 6.5  | 8.5  | $\mu\text{A}$ |
|                  |                          |   | $T_J = -40^\circ\text{C}$ to $85^\circ\text{C}$     |      | 10   |               |
|                  |                          |   | $T_J = -40^\circ\text{C}$ to $125^\circ\text{C}$    |      | 15   |               |
|                  |                          | $V_{EN} = V_{IN} = 6\text{ V}$ , $I_{OUT} = 300\text{ mA}$  |   | 2000 |      |               |
| $I_{SHDN}$       | Shutdown ground current  | $V_{EN} = 0\text{ V}$ (disabled), $V_{IN} = 6.0\text{ V}$ , $T_J = 25^\circ\text{C}$  |   | 0.07 | 0.2  | $\mu\text{A}$ |
| $I_{GND(DO)}$    | $I_{GND}$ in dropout     | $V_{IN} \leq V_{OUT(NOM)}$ , $I_{OUT} = 0\text{ mA}$ , $V_{EN} = V_{IN}$  |   | 6.5  | 15   | $\mu\text{A}$ |
| $V_{DO}$         | Dropout voltage          | $I_{OUT} = 300\text{ mA}$ ,<br>$V_{OUT} = 95\% \times V_{OUT(NOM)}$ ,<br>(DQN, YCJ, YCK packages<br>unless otherwise noted)   | $0.8\text{ V} \leq V_{OUT} < 1.0\text{ V}^{(1)}$    |      | 690  | mV            |
|                  |                          |   | $1.0\text{ V} \leq V_{OUT} < 1.2\text{ V}^{(1)}$    |      | 490  |               |
|                  |                          |   | $1.2\text{ V} \leq V_{OUT} < 1.5\text{ V}^{(1)}$    |      | 355  |               |
|                  |                          |   | $1.5\text{ V} \leq V_{OUT} < 2.5\text{ V}$          |      | 200  |               |
|                  |                          |   | $1.5\text{ V} \leq V_{OUT} < 2.5\text{ V}$<br>(DBV) |      | 205  |               |
|                  |                          |   | $2.5\text{ V} \leq V_{OUT} < 5.5\text{ V}$          |      | 140  |               |
|                  |                          |   | $2.5\text{ V} \leq V_{OUT} < 5.5\text{ V}$<br>(DBV) |      | 145  |               |

## 6.5 Electrical Characteristics (continued)

at operating temperature range ( $T_J = -40^\circ\text{C}$  to  $+125^\circ\text{C}$ ),  $V_{IN} = V_{OUT(NOM)} + 0.3\text{ V}$  or  $1.6\text{ V}$ , whichever is greater,  $V_{EN} = 1.0\text{ V}$ ,  $I_{OUT} = 1\text{ mA}$ ,  $C_{IN} = 1\text{ }\mu\text{F}$ ,  $C_{OUT} = 1\text{ }\mu\text{F}$  (unless otherwise noted); all typical values are at  $T_J = 25^\circ\text{C}$

| PARAMETER           |  | TEST CONDITIONS  |   | MIN  | TYP  | MAX  | UNIT                |
|---------------------|--|--|---|------|------|------|---------------------|
| $I_{CL}$            | Output current limit                           | $V_{OUT} = 0.9 \times V_{OUT(NOM)}$ ,<br>$V_{IN} = V_{OUT(NOM)} + 0.5\text{ V}$              | $V_{OUT} < 1.5\text{ V}$ (YCK, YCK packages)    | 360  | 520  | 770  | mA                  |
|                     |  | $V_{OUT} = 0.9 \times V_{OUT(NOM)}$ ,<br>$V_{IN} = V_{OUT(NOM)} + 0.5\text{ V}$              | $V_{OUT} < 1.5\text{ V}$ (DQN package)          | 360  | 520  | 730  |                     |
|                     |  | $V_{OUT} = V_{OUT(NOM)} - 150\text{ mV}$ ,<br>$V_{IN} = V_{OUT(NOM)} + 0.5\text{ V}$         | $V_{OUT} < 1.5\text{ V}$ (DBV package)          | 360  | 520  | 730  |                     |
|                     |  | $V_{OUT} = 0.9 \times V_{OUT(NOM)}$ ,<br>$V_{IN} = V_{OUT(NOM)} + 0.3\text{ V}$              | $V_{OUT} \geq 1.5\text{ V}$ (YCK, YCK packages) | 360  | 520  | 770  |                     |
|                     |  | $V_{OUT} = 0.9 \times V_{OUT(NOM)}$ ,<br>$V_{IN} = V_{OUT(NOM)} + 0.3\text{ V}$              | $V_{OUT} \geq 1.5\text{ V}$ (DQN package)       | 360  | 520  | 730  |                     |
| $I_{SC}$            | Short-circuit current limit                    | $V_{OUT} = 0\text{ V}$   |   |      | 160  |      | mA                  |
| PSRR                | Power-supply rejection ratio                   | $I_{OUT} = 20\text{ mA}$ ,<br>$V_{IN} = V_{OUT} + 1.0\text{ V}$                              | $f = 100\text{ Hz}$                             |      | 95   |      | dB                  |
|                     |  |  | $f = 1\text{ kHz}$                              |      | 95   |      |                     |
|                     |  |  | $f = 10\text{ kHz}$                             |      | 75   |      |                     |
|                     |  |  | $f = 100\text{ kHz}$                            |      | 75   |      |                     |
|                     |  |  | $f = 1\text{ MHz}$                              |      | 45   |      |                     |
|                     |  | $I_{OUT} = 300\text{ mA}$ ,<br>$V_{IN} = V_{OUT} + 1.0\text{ V}$                             | $f = 100\text{ Hz}$                             |      | 65   |      |                     |
|                     |  |  | $f = 1\text{ kHz}$                              |      | 92   |      |                     |
|                     |  |  | $f = 10\text{ kHz}$                             |      | 75   |      |                     |
|                     |  |  | $f = 100\text{ kHz}$                            |      | 60   |      |                     |
|                     |  |  | $f = 1\text{ MHz}$                              |      | 40   |      |                     |
| $V_N$               | Output noise voltage                           | BW = 10 Hz to 100 kHz,<br>$V_{OUT} = 2.8\text{ V}$   | $I_{OUT} = 300\text{ mA}$                       |      | 7    |      | $\mu\text{V}_{RMS}$ |
|                     |  |  | $I_{OUT} = 1\text{ mA}$                         |      | 10   |      |                     |
| $R_{PULLDOWN}$      | Output automatic discharge pulldown resistance | $V_{EN} < V_{EN(LOW)}$ (output disabled), $V_{IN} = 3.1\text{ V}$                            |   |      | 150  |      | $\Omega$            |
| $T_{SD}$            | Thermal shutdown                               | $T_J$ rising   |   |      | 165  |      | $^\circ\text{C}$    |
|                     |  | $T_J$ falling  |   |      | 140  |      |                     |
| $V_{EN(LOW)}$       | Low input threshold                            | $V_{IN} = 1.6\text{ V}$ to $6.0\text{ V}$ ,<br>$V_{EN}$ falling until the output is disabled |   |      |      | 0.3  | V                   |
| $V_{EN(HI)}$        | High input threshold                           | $V_{IN} = 1.6\text{ V}$ to $6.0\text{ V}$ ,<br>$V_{EN}$ rising until the output is enabled   |   | 0.9  |      |      | V                   |
| $V_{UVLO}$          | UVLO threshold                                 | $V_{IN}$ rising (YCK and YCK packages)   |   | 1.11 | 1.35 | 1.59 | V                   |
|                     |  | $V_{IN}$ rising (DBV and DQN packages)   |   | 1.17 | 1.35 | 1.59 |                     |
|                     |  | $V_{IN}$ falling (YCK and YCK packages)  |   | 1.05 | 1.3  | 1.55 |                     |
|                     |  | $V_{IN}$ falling (DBV and DQN packages)  |   | 1.11 | 1.3  | 1.55 |                     |
| $V_{UVLO(HYST)}$    | UVLO hysteresis                                |  |   |      | 50   |      | mV                  |
| $I_{EN}$            | EN input leakage current                       | $V_{EN} = 6.0\text{ V}$ and $V_{IN} = 6.0\text{ V}$  |   |      | 90   | 250  | nA                  |
| $R_{EN(PULL-DOWN)}$ | Smart enable pulldown resistor                 | $V_{EN} = 0.25\text{ V}$   |   |      | 500  |      | K $\Omega$          |

(1) Design simulation data only

## 6.6 Switching Characteristics

at operating temperature range ( $T_J = -40^\circ\text{C}$  to  $+125^\circ\text{C}$ ),  $V_{IN} = V_{OUT(NOM)} + 0.3\text{ V}$  or  $1.6\text{ V}$ , whichever is greater,  $V_{EN} = 1.0\text{ V}$ ,  $I_{OUT} = 1\text{ mA}$ ,  $C_{IN} = 1\text{ }\mu\text{F}$ ,  $C_{OUT} = 1\text{ }\mu\text{F}$  (unless otherwise noted); all typical values are at  $T_J = 25^\circ\text{C}$

| PARAMETER |               | TEST CONDITIONS  |  | MIN | TYP | MAX  | UNIT          |
|-----------|---------------|--|--|-----|-----|------|---------------|
| $t_{STR}$ | Start-up time | From $V_{EN} > V_{EN(HI)}$ to $V_{OUT} = 95\%$ of $V_{OUT(NOM)}$ , |  |     | 750 | 1150 | $\mu\text{s}$ |

## 6.7 Typical Characteristics

$V_{IN} = V_{OUT(NOM)} + 0.3 \text{ V}$  or  $1.6 \text{ V}$  (whichever is greater),  $V_{OUT} = 2.8 \text{ V}$ ,  $I_{OUT} = 1 \text{ mA}$ ,  $C_{IN} = 1 \mu\text{F}$ ,  $C_{OUT} = 1 \mu\text{F}$ , and  $T_A = 25^\circ\text{C}$  (unless otherwise noted)



图 6-1. Line Regulation vs  $V_{IN}$



图 6-2. Line Regulation vs  $V_{IN}$

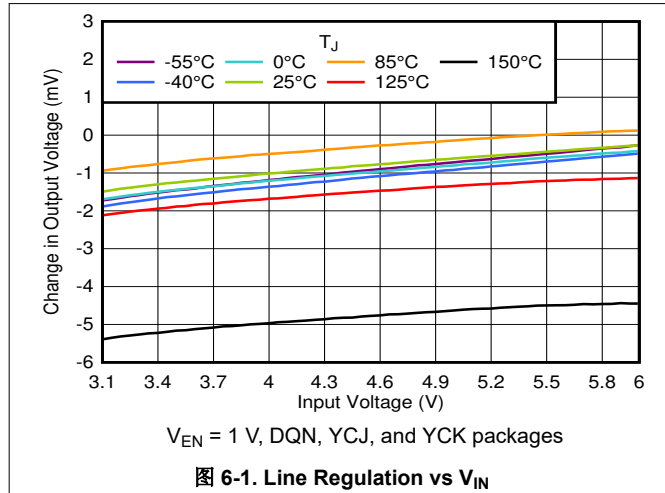

图 6-3. Line Regulation vs  $V_{IN}$

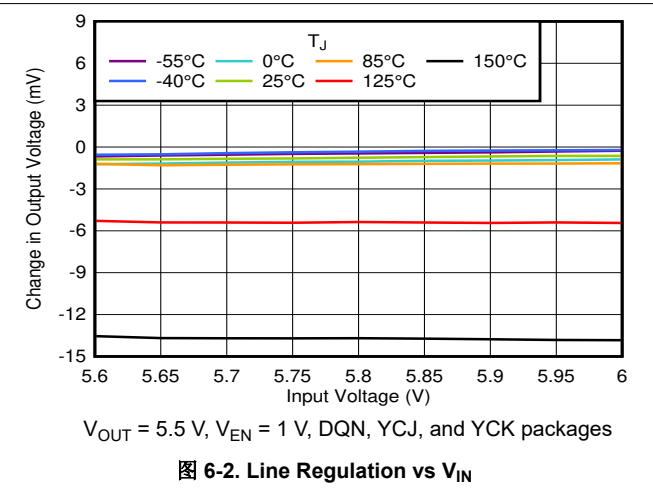

图 6-4. Line Regulation vs  $V_{IN}$

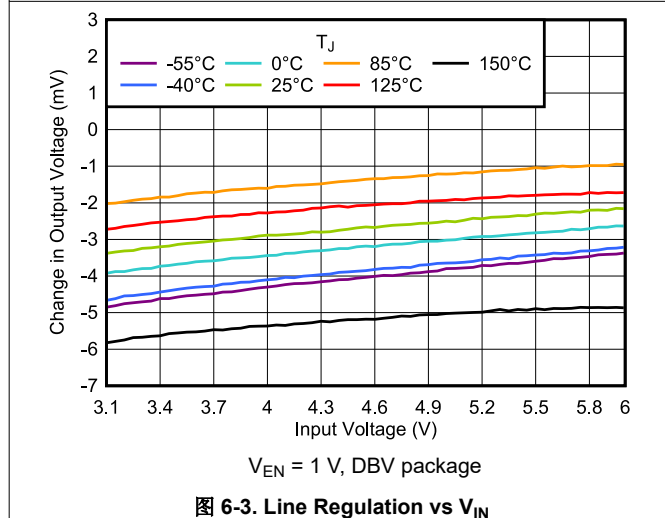

图 6-5. Load Regulation vs  $I_{OUT}$

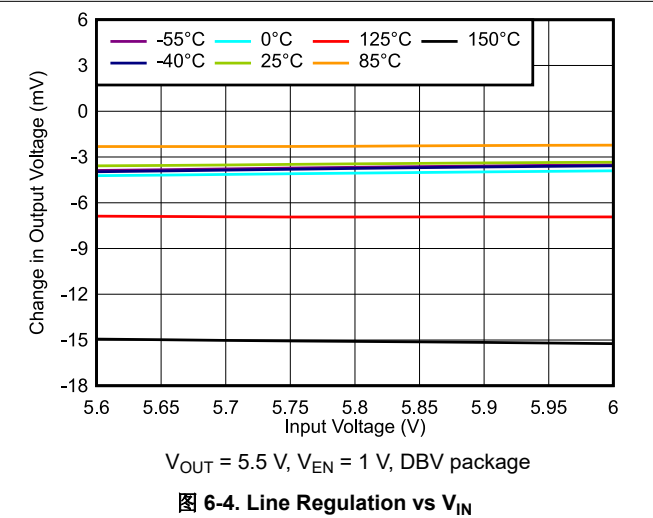

图 6-6. Load Regulation vs  $I_{OUT}$

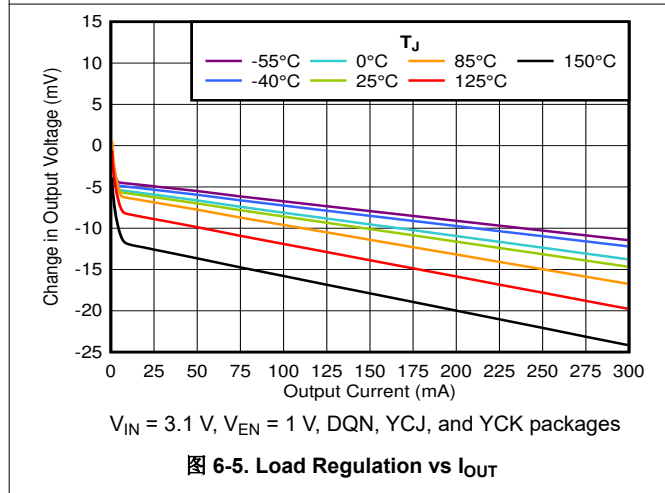

## 6.7 Typical Characteristics (continued)

$V_{IN} = V_{OUT(NOM)} + 0.3\text{ V}$  or  $1.6\text{ V}$  (whichever is greater),  $V_{OUT} = 2.8\text{ V}$ ,  $I_{OUT} = 1\text{ mA}$ ,  $C_{IN} = 1\text{ }\mu\text{F}$ ,  $C_{OUT} = 1\text{ }\mu\text{F}$ , and  $T_A = 25^\circ\text{C}$  (unless otherwise noted)

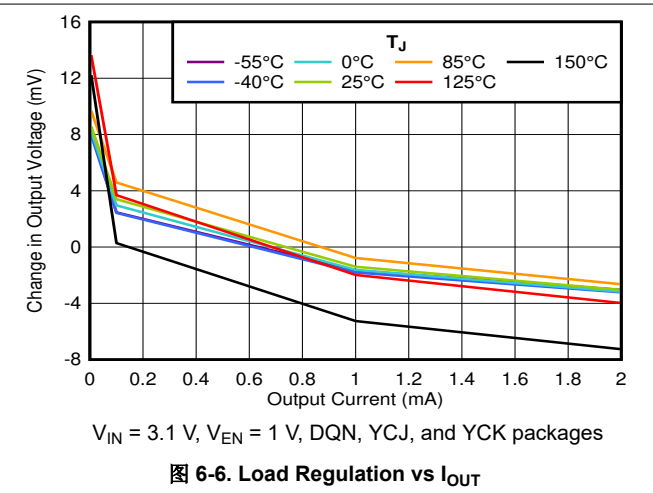

图 6-7. Load Regulation vs  $I_{OUT}$



图 6-8. Load Regulation vs  $I_{OUT}$

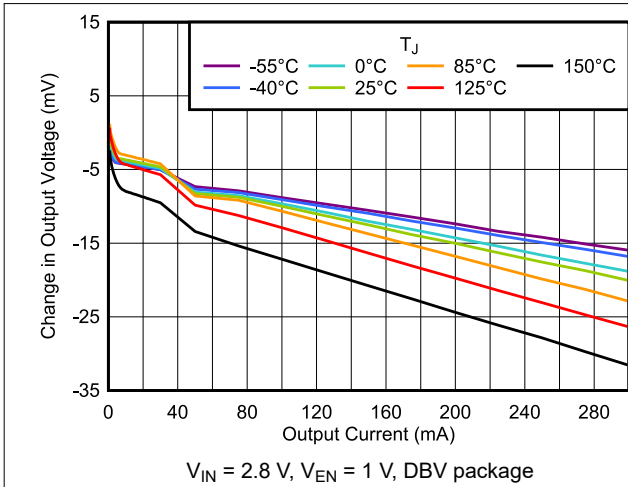

图 6-9. Load Regulation vs  $I_{OUT}$

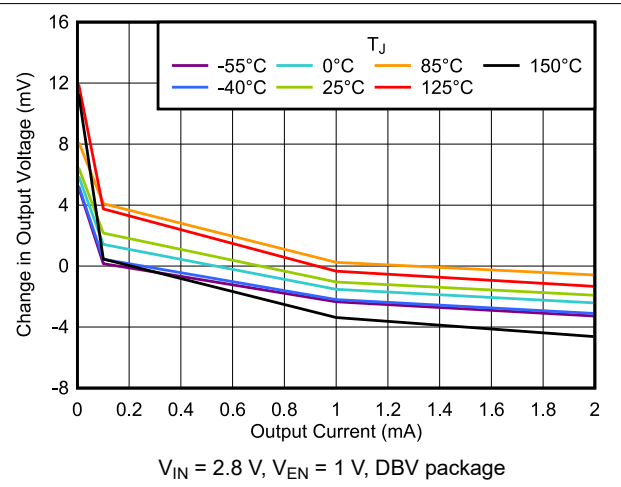

图 6-10. Load Regulation vs  $I_{OUT}$

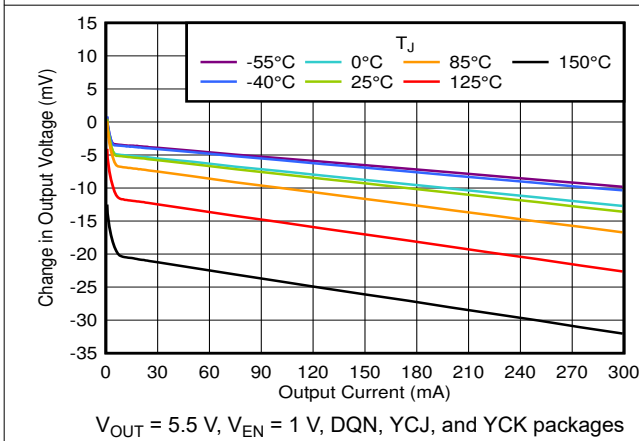

图 6-11. Load Regulation vs  $I_{OUT}$

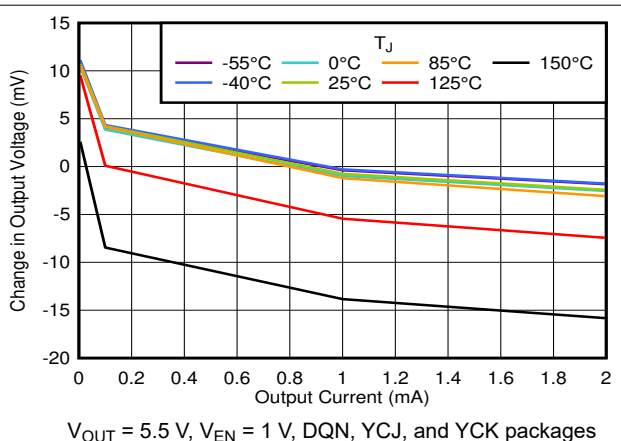

图 6-12. Load Regulation vs  $I_{OUT}$

### 6.7 Typical Characteristics (continued)

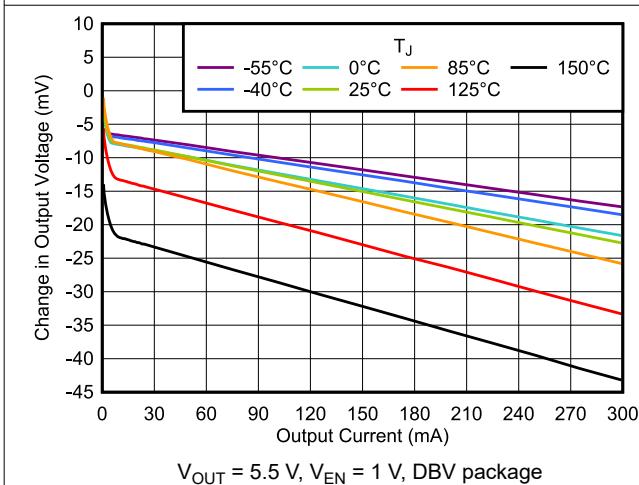
$V_{IN} = V_{OUT(NOM)} + 0.3\text{ V}$  or  $1.6\text{ V}$  (whichever is greater),  $V_{OUT} = 2.8\text{ V}$ ,  $I_{OUT} = 1\text{ mA}$ ,  $C_{IN} = 1\text{ }\mu\text{F}$ ,  $C_{OUT} = 1\text{ }\mu\text{F}$ , and  $T_A = 25^\circ\text{C}$  (unless otherwise noted)

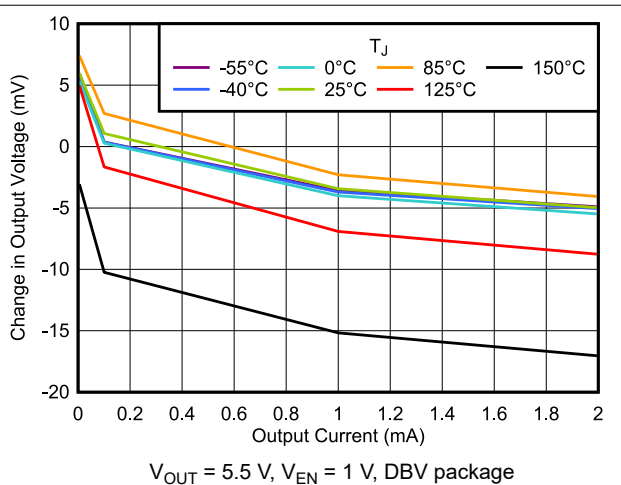
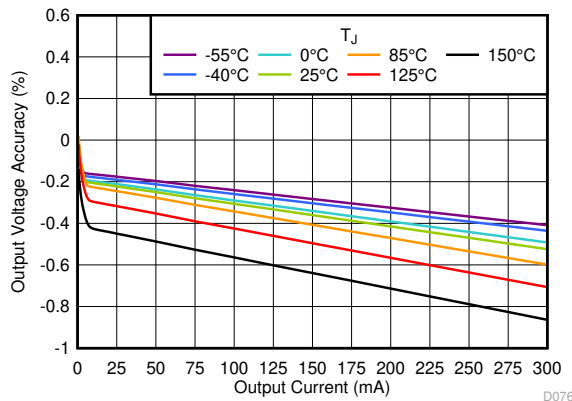

$V_{EN} = 1\text{ V}$ , DQN, YCJ, and YCK packages

图 6-13. Output Voltage Accuracy vs  $I_{OUT}$

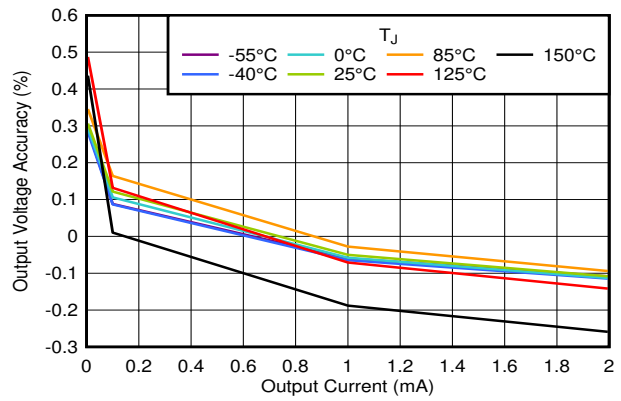

$V_{EN} = 1\text{ V}$ , DQN, YCJ, and YCK packages

图 6-14. Output Voltage Accuracy vs  $I_{OUT}$

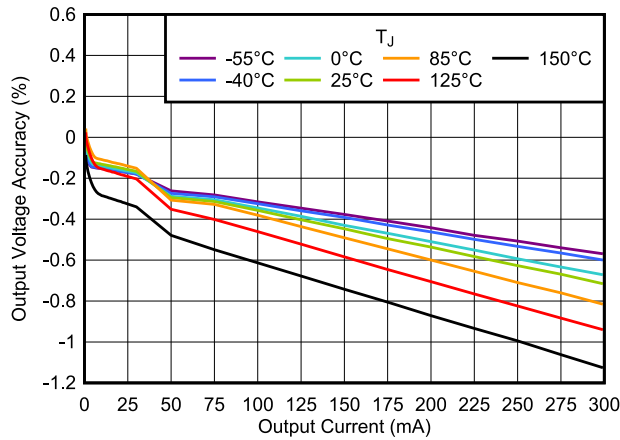

$V_{EN} = 1\text{ V}$ , DBV package

图 6-15. Output Voltage Accuracy vs  $I_{OUT}$

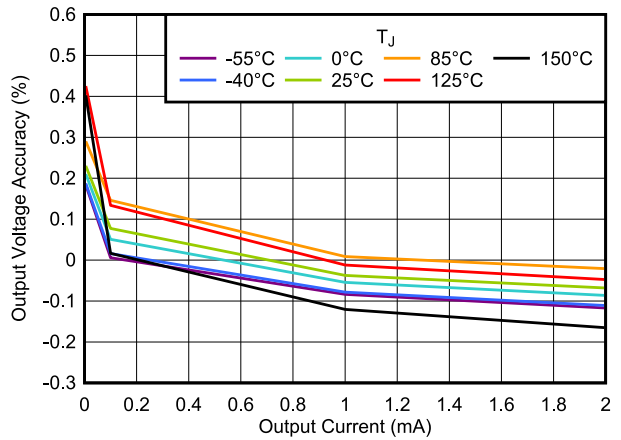

$V_{EN} = 1\text{ V}$ , DBV package

图 6-16. Output Voltage Accuracy vs  $I_{OUT}$

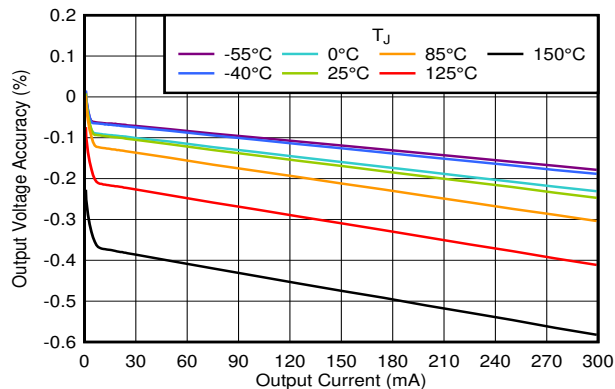

$V_{OUT} = 5.5\text{ V}$ ,  $V_{EN} = 1\text{ V}$ , DQN, YCJ, and YCK packages

图 6-17. Output Voltage Accuracy vs  $I_{OUT}$

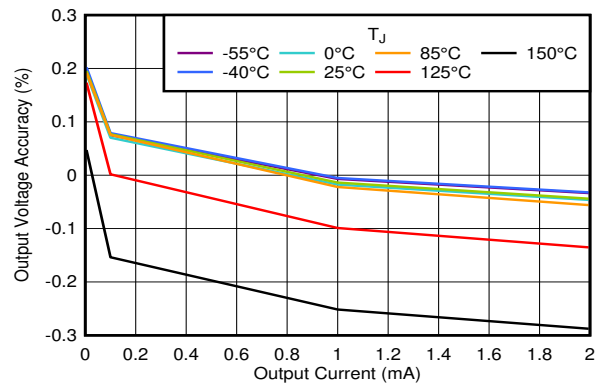

$V_{OUT} = 5.5\text{ V}$ ,  $V_{EN} = 1\text{ V}$ , DQN, YCJ, and YCK packages

图 6-18. Output Voltage Accuracy vs  $I_{OUT}$

### 6.7 Typical Characteristics (continued)

$V_{IN} = V_{OUT(NOM)} + 0.3\text{ V}$  or  $1.6\text{ V}$  (whichever is greater),  $V_{OUT} = 2.8\text{ V}$ ,  $I_{OUT} = 1\text{ mA}$ ,  $C_{IN} = 1\text{ }\mu\text{F}$ ,  $C_{OUT} = 1\text{ }\mu\text{F}$ , and  $T_A = 25^\circ\text{C}$  (unless otherwise noted)

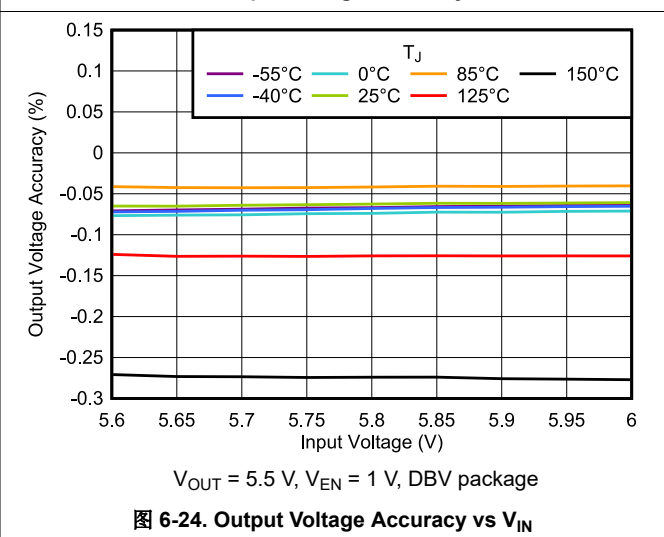
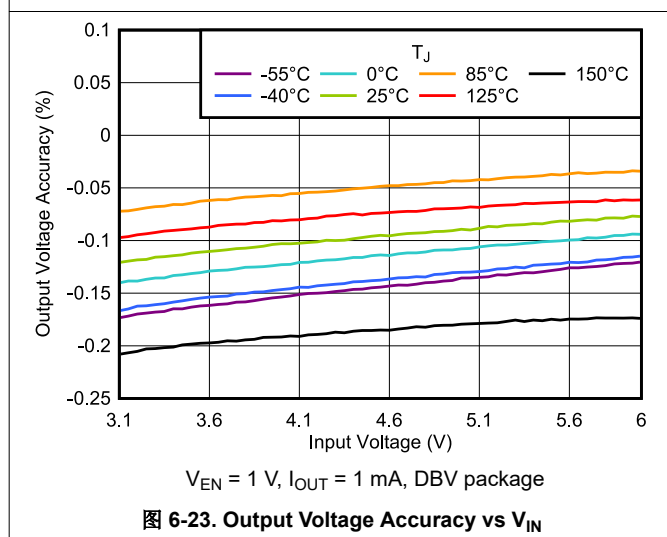
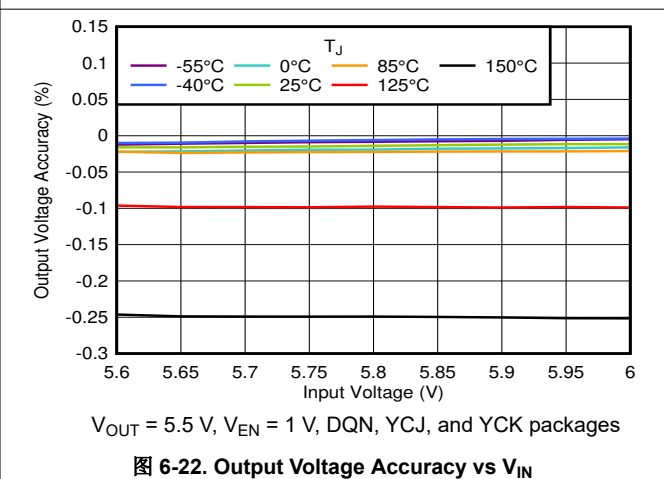
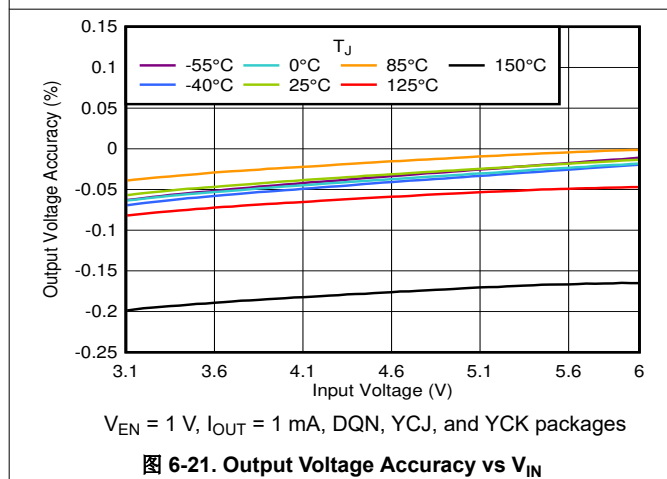
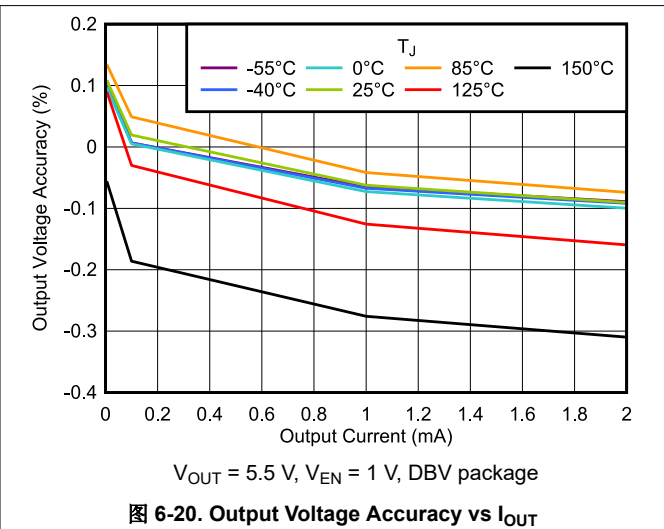
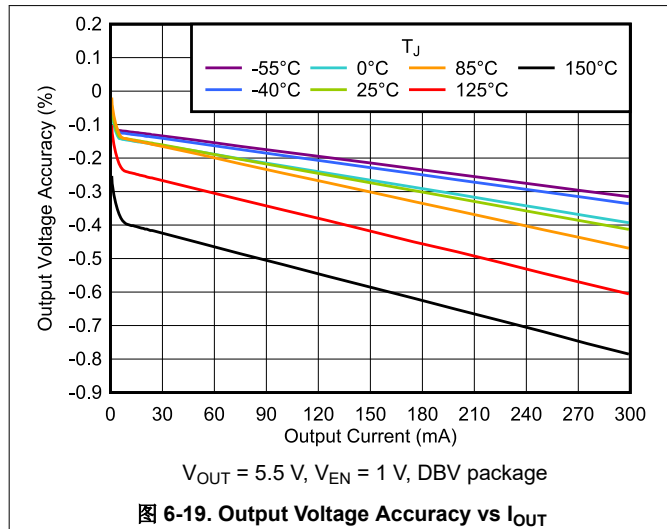

### 6.7 Typical Characteristics (continued)

$V_{IN} = V_{OUT(NOM)} + 0.3\text{ V}$  or  $1.6\text{ V}$  (whichever is greater),  $V_{OUT} = 2.8\text{ V}$ ,  $I_{OUT} = 1\text{ mA}$ ,  $C_{IN} = 1\text{ }\mu\text{F}$ ,  $C_{OUT} = 1\text{ }\mu\text{F}$ , and  $T_A = 25^\circ\text{C}$  (unless otherwise noted)

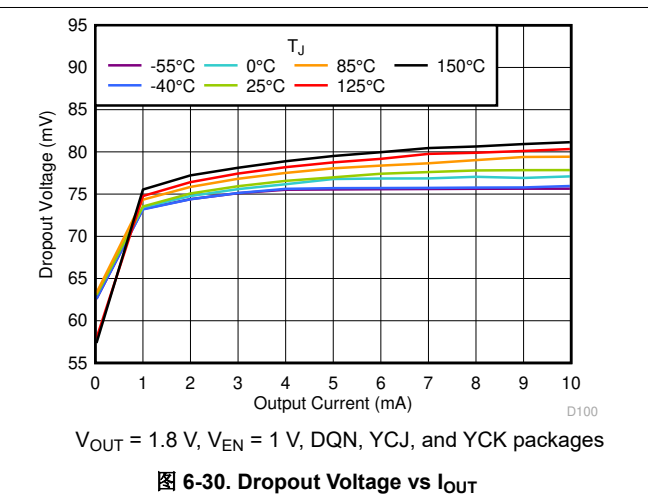
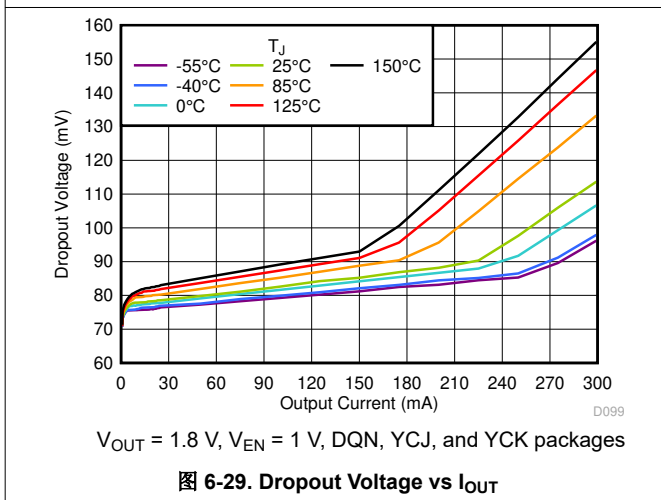
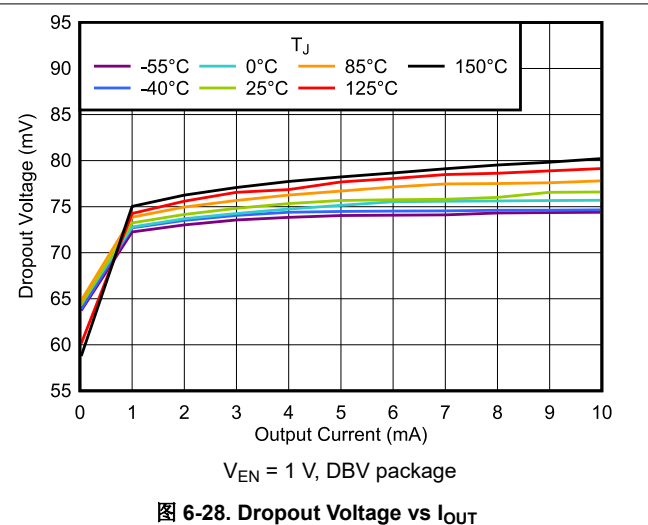
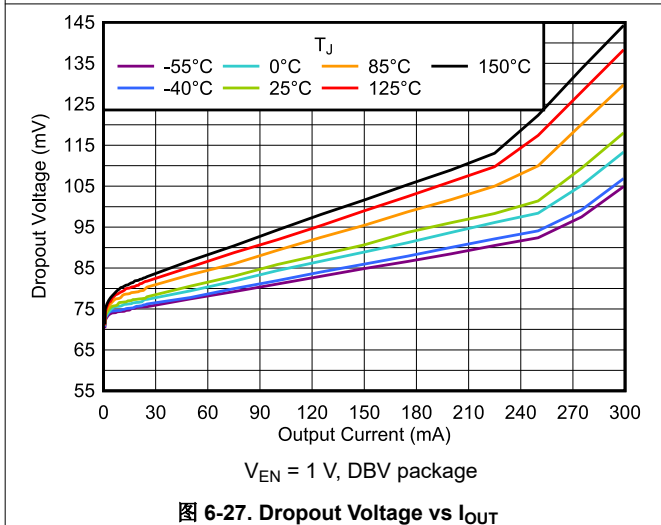
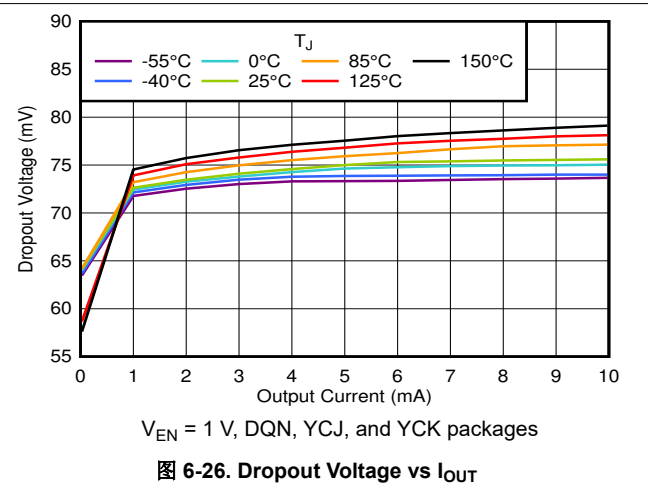
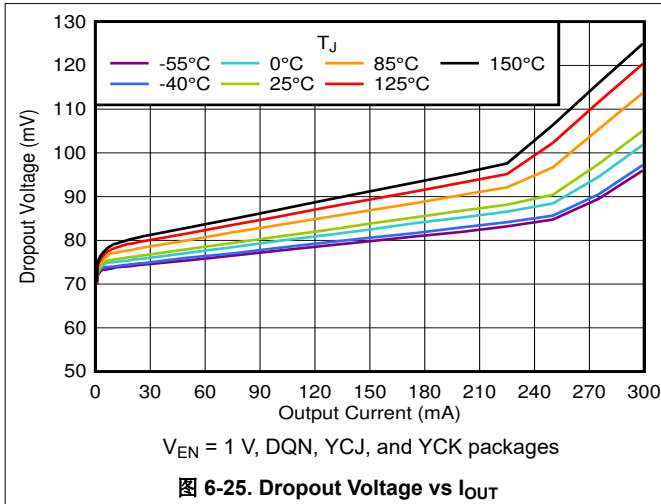

## 6.7 Typical Characteristics (continued)

$V_{IN} = V_{OUT(NOM)} + 0.3 \text{ V}$  or  $1.6 \text{ V}$  (whichever is greater),  $V_{OUT} = 2.8 \text{ V}$ ,  $I_{OUT} = 1 \text{ mA}$ ,  $C_{IN} = 1 \mu\text{F}$ ,  $C_{OUT} = 1 \mu\text{F}$ , and  $T_A = 25^\circ\text{C}$  (unless otherwise noted)

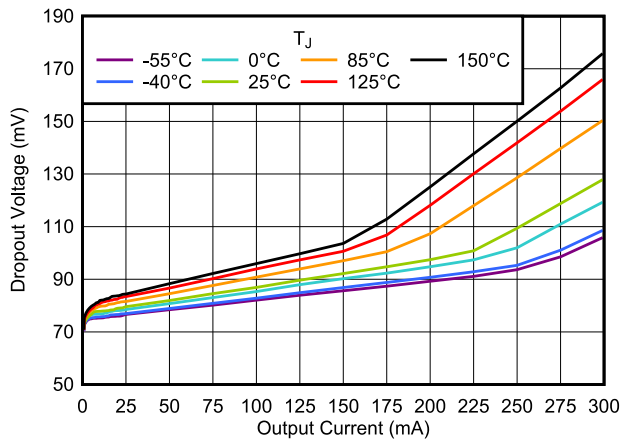

$V_{OUT} = 1.8 \text{ V}$ ,  $V_{EN} = 1 \text{ V}$ , DBV package

图 6-31. Dropout Voltage vs  $I_{OUT}$

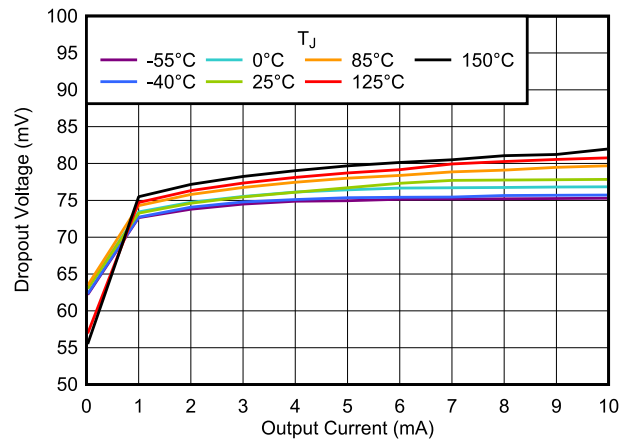

$V_{OUT} = 1.8 \text{ V}$ ,  $V_{EN} = 1 \text{ V}$ , DBV package

图 6-32. Dropout Voltage vs  $I_{OUT}$

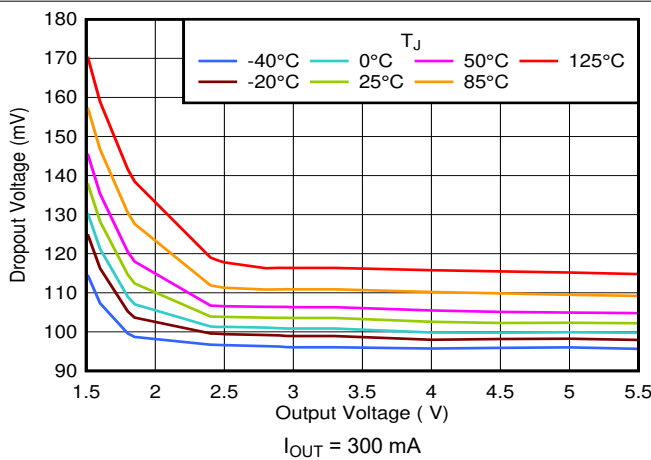

$I_{OUT} = 300 \text{ mA}$

图 6-33. Dropout Voltage vs  $V_{OUT}$

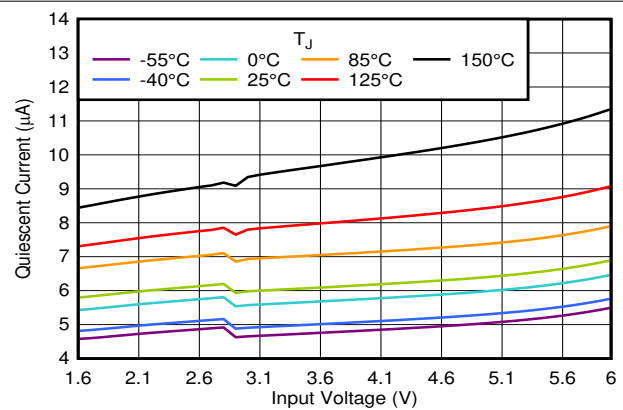

$V_{EN} = 1 \text{ V}$ ,  $I_{OUT} = 0 \text{ mA}$

图 6-34.  $I_{GND}$  vs  $V_{IN}$

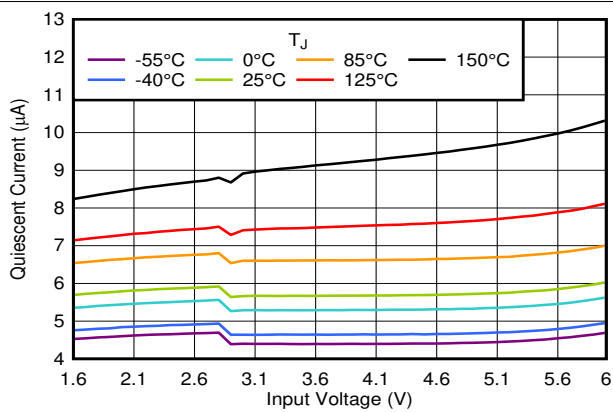

$V_{EN} = V_{IN}$ ,  $I_{OUT} = 0 \text{ mA}$

图 6-35.  $I_{GND}$  vs  $V_{IN}$

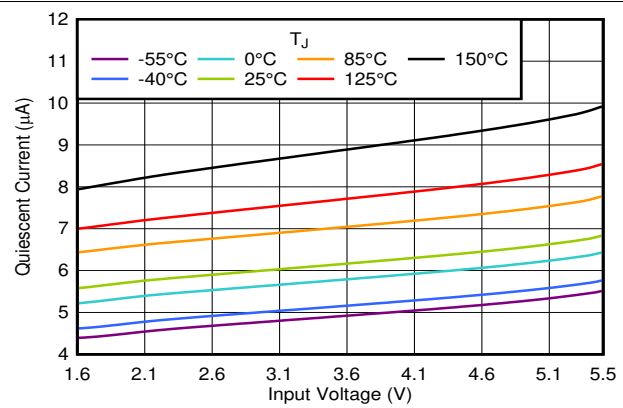

$V_{OUT(NOM)} = 5.5 \text{ V}$ ,  $V_{EN} = 1 \text{ V}$ ,  $I_{OUT} = 0 \text{ mA}$

图 6-36.  $I_{GND}$  vs  $V_{IN}$  in the Dropout Region

### 6.7 Typical Characteristics (continued)

$V_{IN} = V_{OUT(NOM)} + 0.3\text{ V}$  or  $1.6\text{ V}$  (whichever is greater),  $V_{OUT} = 2.8\text{ V}$ ,  $I_{OUT} = 1\text{ mA}$ ,  $C_{IN} = 1\text{ }\mu\text{F}$ ,  $C_{OUT} = 1\text{ }\mu\text{F}$ , and  $T_A = 25^\circ\text{C}$  (unless otherwise noted)

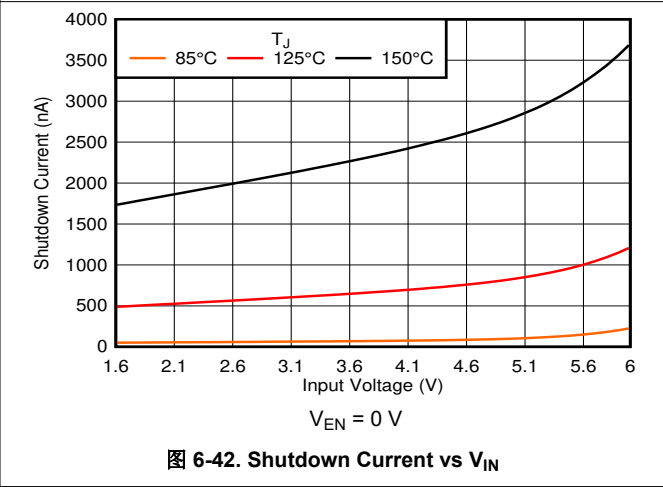
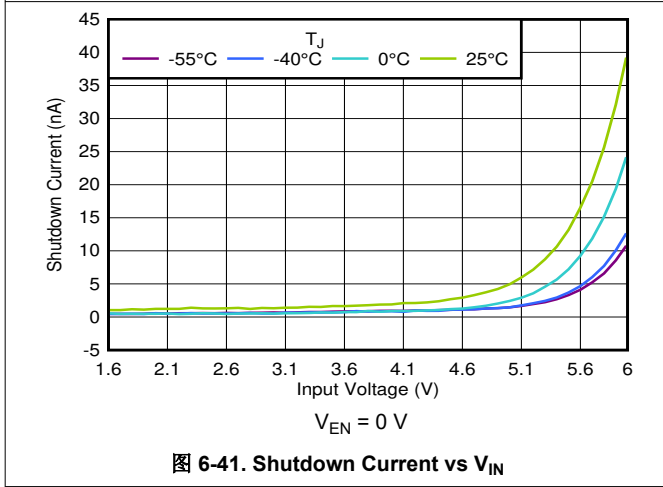
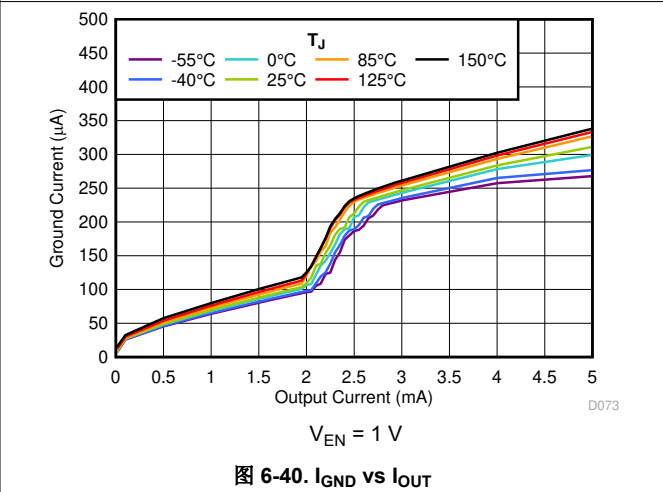
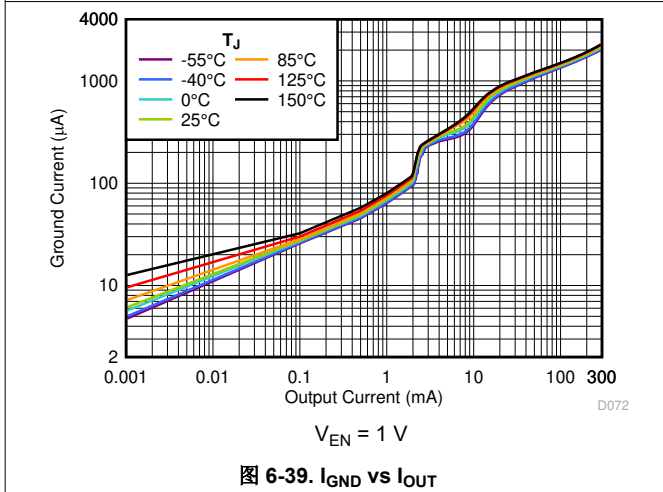
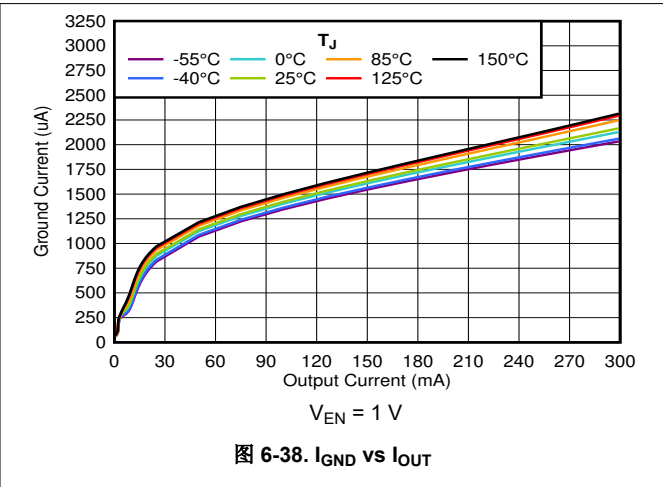
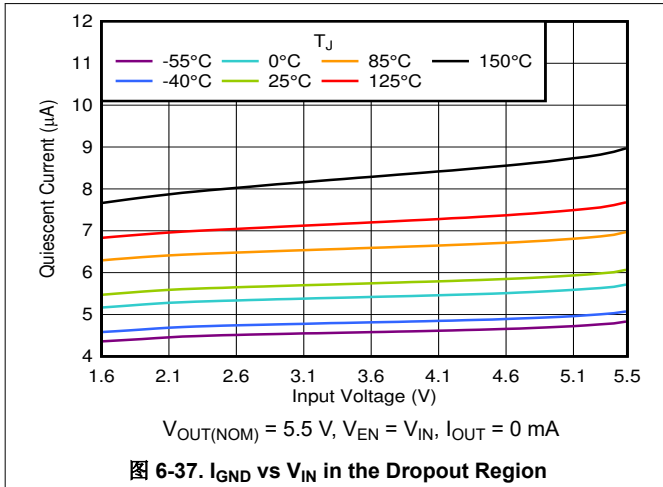

### 6.7 Typical Characteristics (continued)

$V_{IN} = V_{OUT(NOM)} + 0.3\text{ V}$  or  $1.6\text{ V}$  (whichever is greater),  $V_{OUT} = 2.8\text{ V}$ ,  $I_{OUT} = 1\text{ mA}$ ,  $C_{IN} = 1\text{ }\mu\text{F}$ ,  $C_{OUT} = 1\text{ }\mu\text{F}$ , and  $T_A = 25^\circ\text{C}$  (unless otherwise noted)

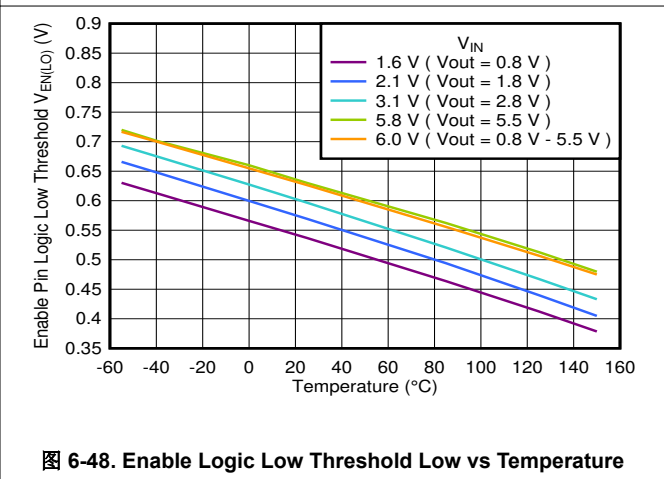
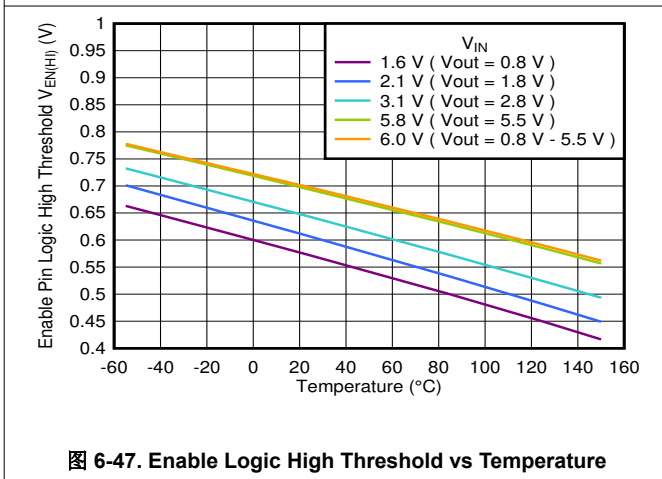
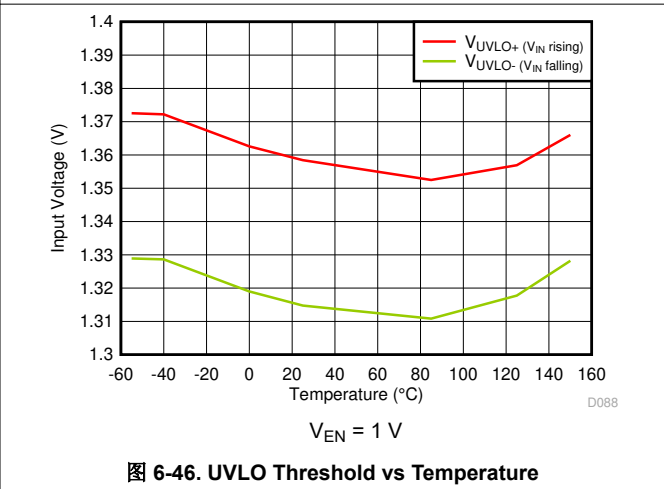
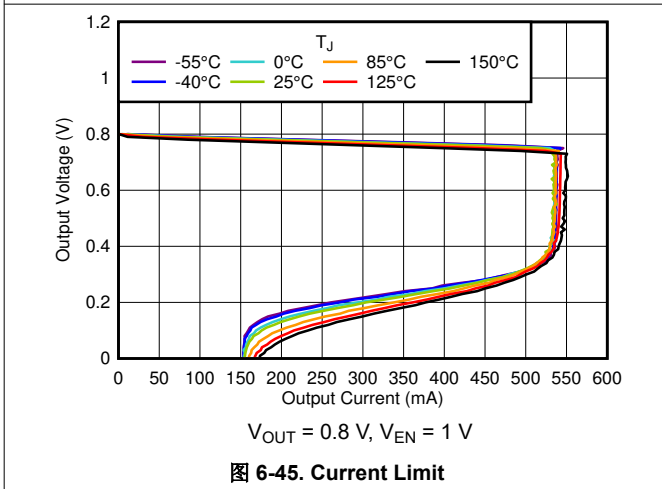
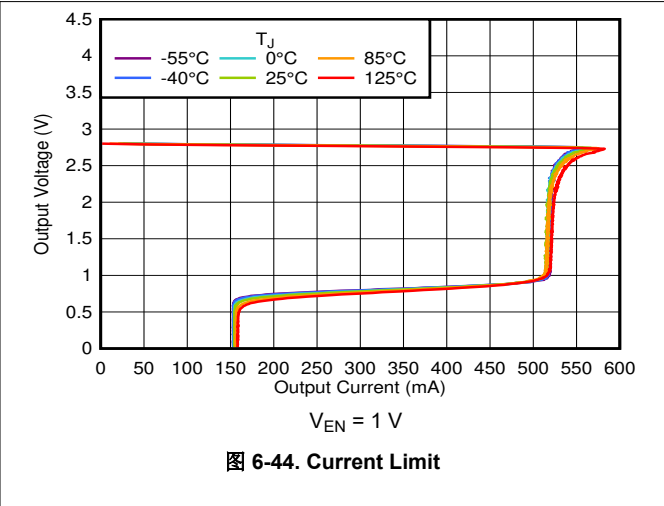
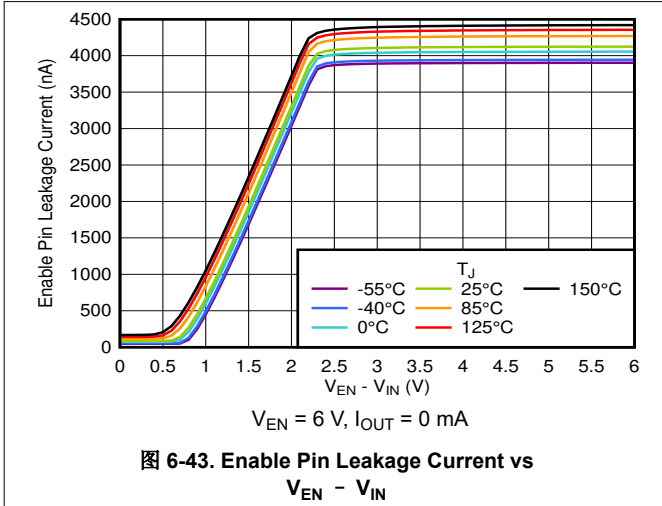

### 6.7 Typical Characteristics (continued)

$V_{IN} = V_{OUT(NOM)} + 0.3\text{ V}$  or  $1.6\text{ V}$  (whichever is greater),  $V_{OUT} = 2.8\text{ V}$ ,  $I_{OUT} = 1\text{ mA}$ ,  $C_{IN} = 1\text{ }\mu\text{F}$ ,  $C_{OUT} = 1\text{ }\mu\text{F}$ , and  $T_A = 25^\circ\text{C}$  (unless otherwise noted)



图 6-49. Output Pulldown Resistor vs Temperature



图 6-50. Smart Enable Pulldown Resistor vs Temperature and  $V_{IN}$

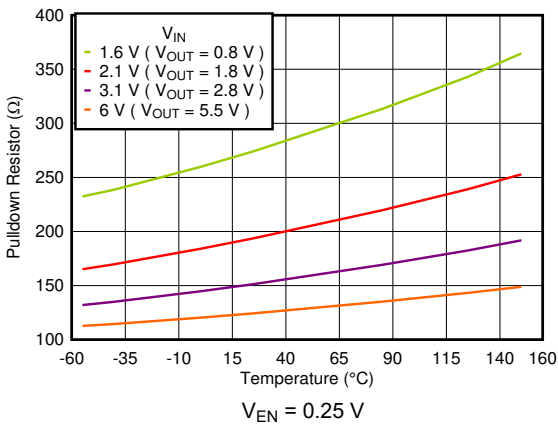

图 6-51. Load Transient

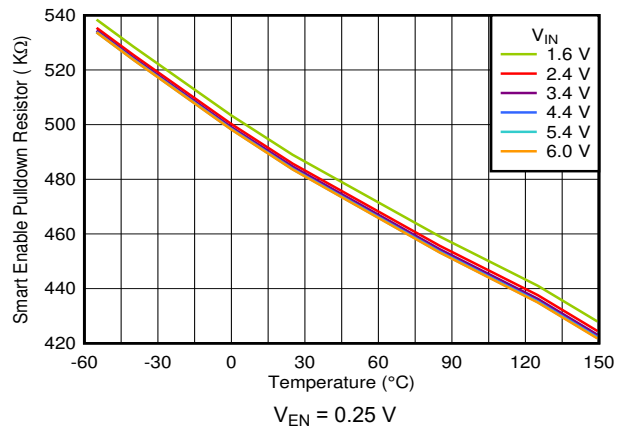

图 6-52. Load Transient

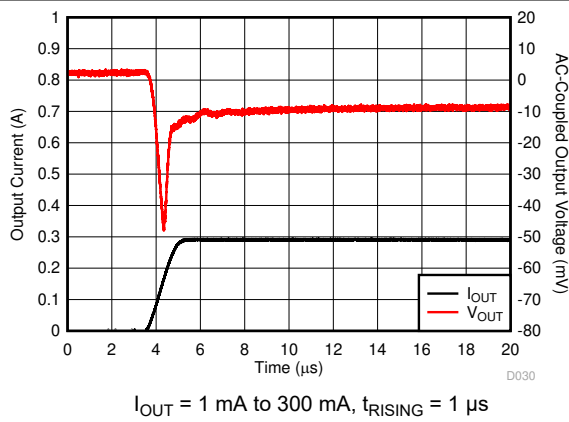

图 6-53. Load Transient

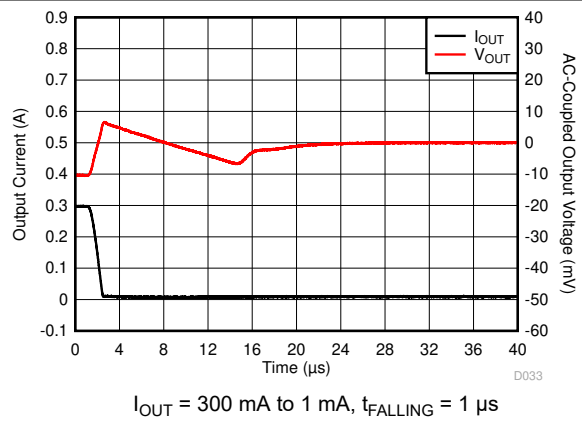

图 6-54. Load Transient

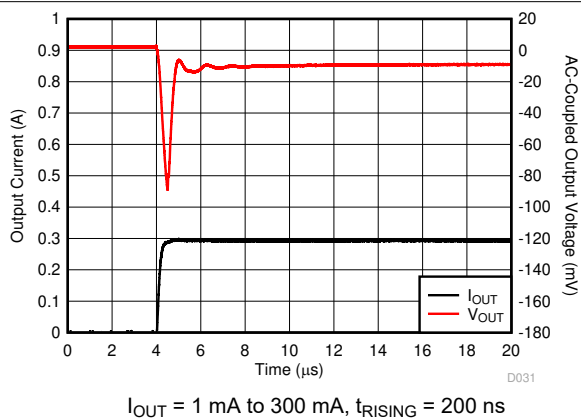

## 6.7 Typical Characteristics (continued)

$V_{IN} = V_{OUT(NOM)} + 0.3\text{ V}$  or  $1.6\text{ V}$  (whichever is greater),  $V_{OUT} = 2.8\text{ V}$ ,  $I_{OUT} = 1\text{ mA}$ ,  $C_{IN} = 1\text{ }\mu\text{F}$ ,  $C_{OUT} = 1\text{ }\mu\text{F}$ , and  $T_A = 25^\circ\text{C}$  (unless otherwise noted)

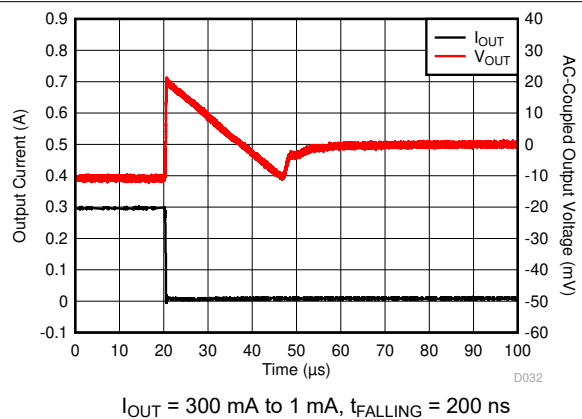
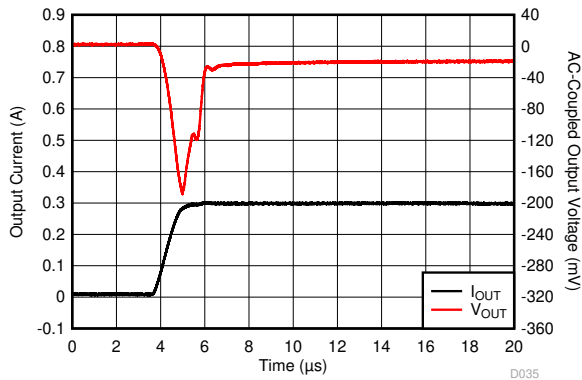

$I_{OUT} = 0\text{ mA to }300\text{ mA}$ ,  $t_{RISING} = 1\text{ }\mu\text{s}$

图 6-55. Load Transient

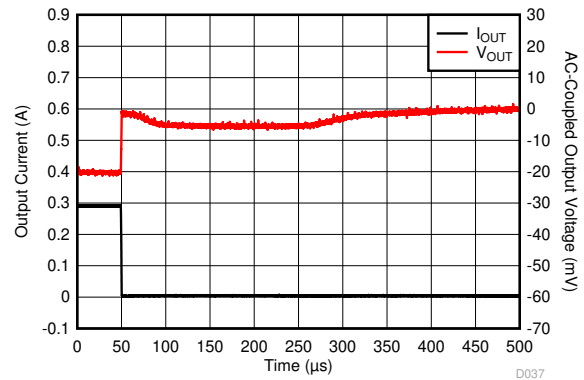

$I_{OUT} = 300\text{ mA to }0\text{ mA}$ ,  $t_{FALLING} = 1\text{ }\mu\text{s}$

图 6-56. Load Transient

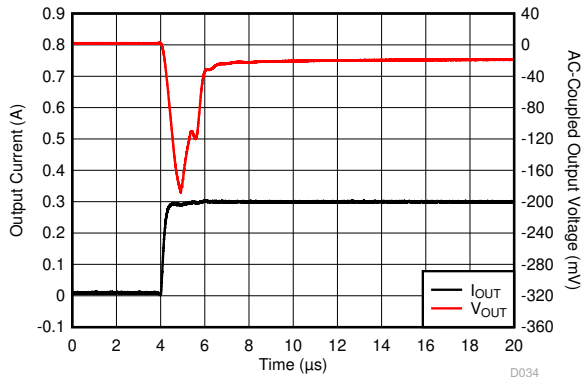

$I_{OUT} = 0\text{ mA to }300\text{ mA}$ ,  $t_{RISING} = 200\text{ ns}$

图 6-57. Load Transient

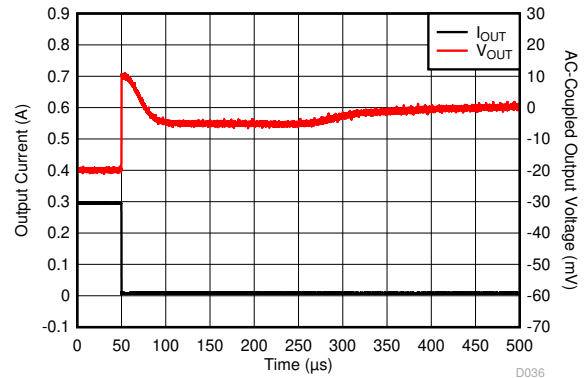

$I_{OUT} = 300\text{ mA to }0\text{ mA}$ ,  $t_{FALLING} = 200\text{ ns}$

图 6-58. Load Transient

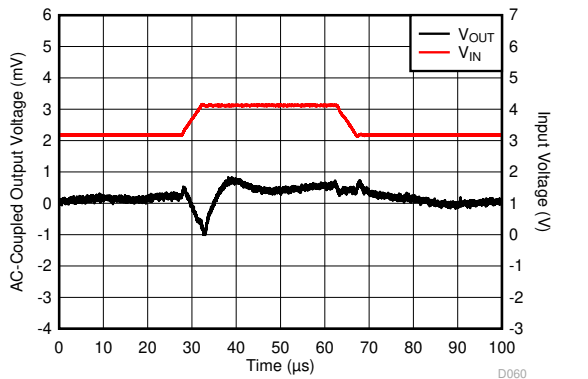

$V_{IN} = 3.1\text{ V} \rightarrow 4.1\text{ V} \rightarrow 3.1\text{ V}$ ,  $V_{IN} t_{RISING} = 5\text{ }\mu\text{s}$ ,  $I_{OUT} = 1\text{ mA}$

图 6-59. Line Transient

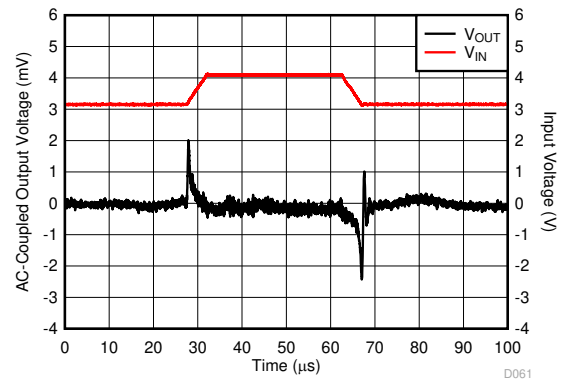

$V_{IN} = 3.1\text{ V} \rightarrow 4.1\text{ V} \rightarrow 3.1\text{ V}$ ,  $V_{IN} t_{RISING} = 5\text{ }\mu\text{s}$ ,  $I_{OUT} = 300\text{ mA}$

图 6-60. Line Transient

### 6.7 Typical Characteristics (continued)

$V_{IN} = V_{OUT(NOM)} + 0.3\text{ V}$  or  $1.6\text{ V}$  (whichever is greater),  $V_{OUT} = 2.8\text{ V}$ ,  $I_{OUT} = 1\text{ mA}$ ,  $C_{IN} = 1\text{ }\mu\text{F}$ ,  $C_{OUT} = 1\text{ }\mu\text{F}$ , and  $T_A = 25^\circ\text{C}$  (unless otherwise noted)



图 6-61. PSRR vs  $V_{IN}$  vs Frequency and  $V_{IN}$



图 6-62. PSRR vs Frequency and  $V_{IN}$

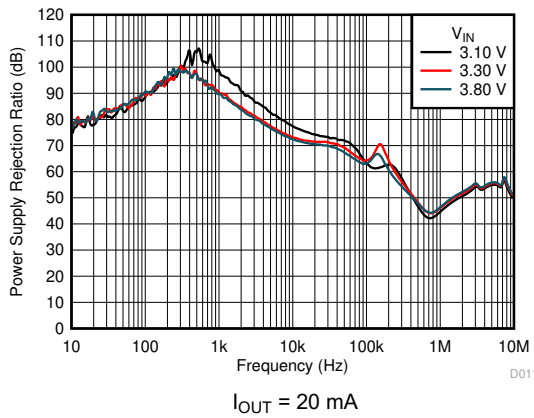

图 6-63. PSRR vs Frequency and  $I_{OUT}$

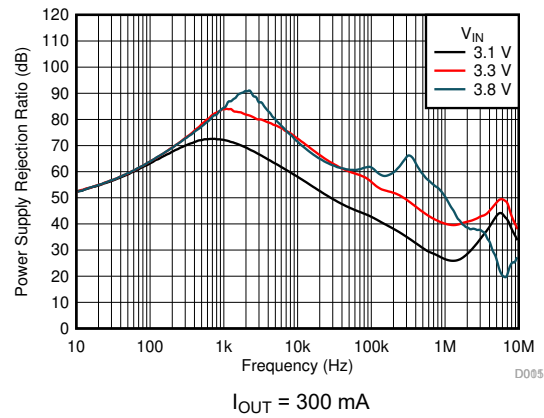

图 6-64. PSRR vs Frequency and  $C_{OUT}$

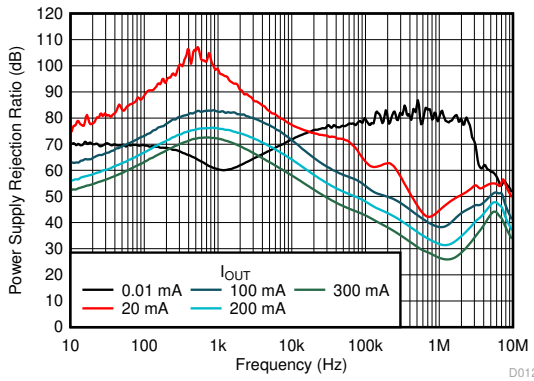

图 6-65. Noise vs Frequency and  $I_{OUT}$

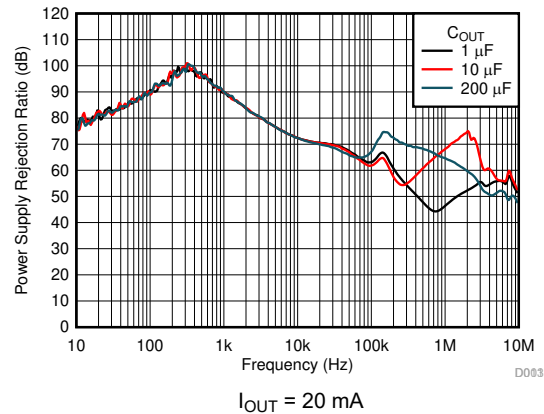

图 6-66. Noise vs Frequency and  $V_{IN}$

## 6.7 Typical Characteristics (continued)

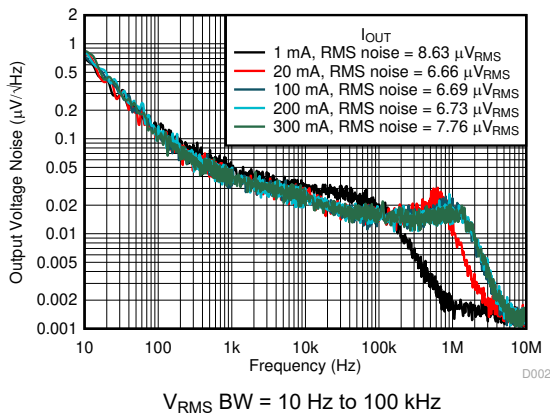
$V_{IN} = V_{OUT(NOM)} + 0.3\text{ V}$  or  $1.6\text{ V}$  (whichever is greater),  $V_{OUT} = 2.8\text{ V}$ ,  $I_{OUT} = 1\text{ mA}$ ,  $C_{IN} = 1\text{ }\mu\text{F}$ ,  $C_{OUT} = 1\text{ }\mu\text{F}$ , and  $T_A = 25^\circ\text{C}$  (unless otherwise noted)

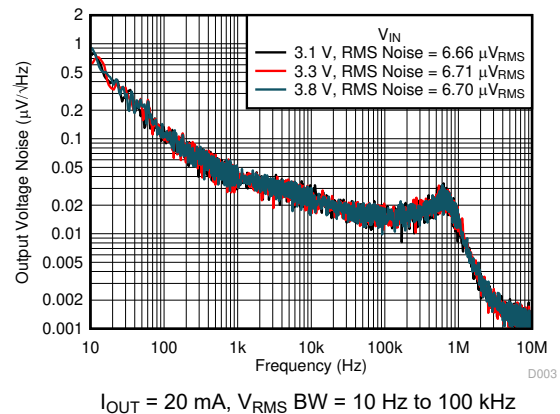
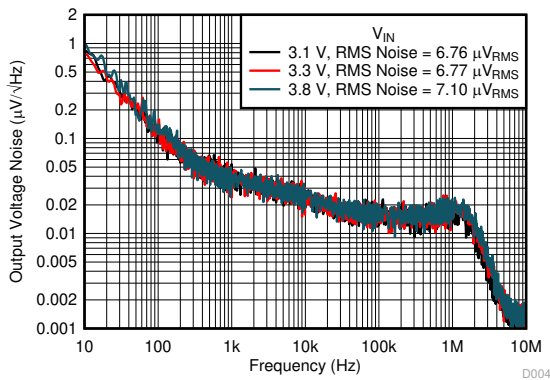

$I_{OUT} = 300\text{ mA}$ ,  $V_{RMS}\text{ BW} = 10\text{ Hz to }100\text{ kHz}$

图 6-67. Noise vs Frequency and  $V_{IN}$

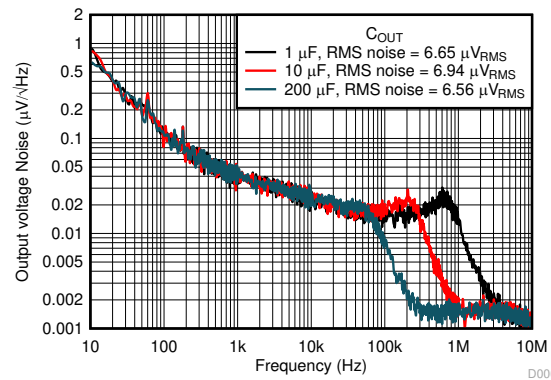

$V_{IN} = 3.8\text{ V}$ ,  $I_{OUT} = 20\text{ mA}$ ,  $V_{RMS}\text{ BW} = 10\text{ Hz to }100\text{ kHz}$

图 6-68. Noise vs Frequency and  $C_{OUT}$

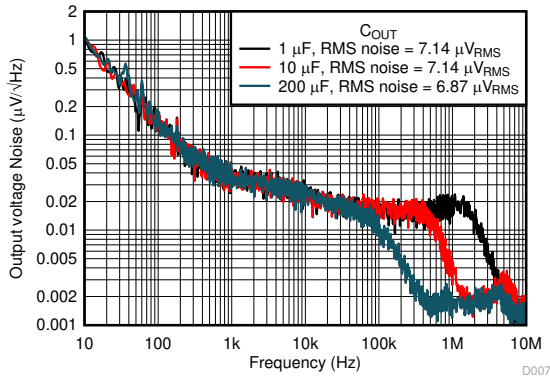

$V_{IN} = 3.8\text{ V}$ ,  $I_{OUT} = 300\text{ mA}$ ,  $V_{RMS}\text{ BW} = 10\text{ Hz to }100\text{ kHz}$

图 6-69. Noise vs Frequency and  $C_{OUT}$

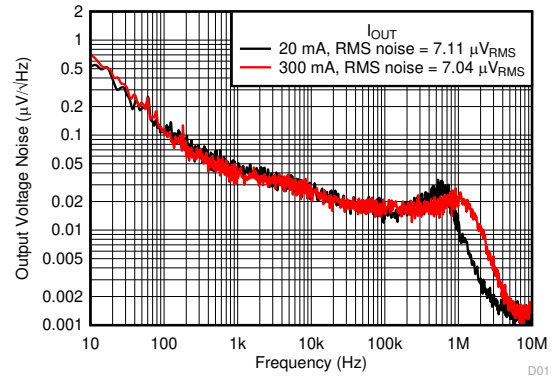

$V_{OUT} = 0.8\text{ V}$ ,  $V_{RMS}\text{ BW} = 10\text{ Hz to }100\text{ kHz}$

图 6-70. Noise vs Frequency and  $I_{OUT}$

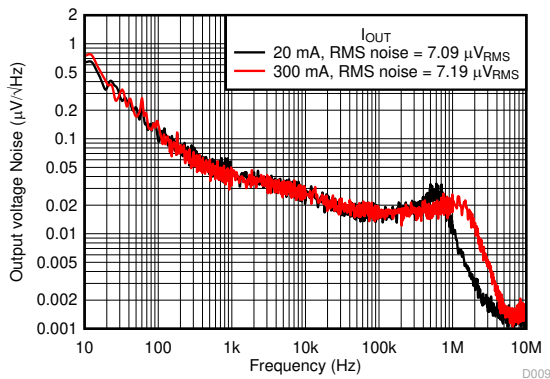

$V_{OUT} = 0.8\text{ V}$ ,  $V_{IN} = 1.8\text{ V}$ ,  $V_{RMS}\text{ BW} = 10\text{ Hz to }100\text{ kHz}$

图 6-71. Noise vs Frequency and  $I_{OUT}$

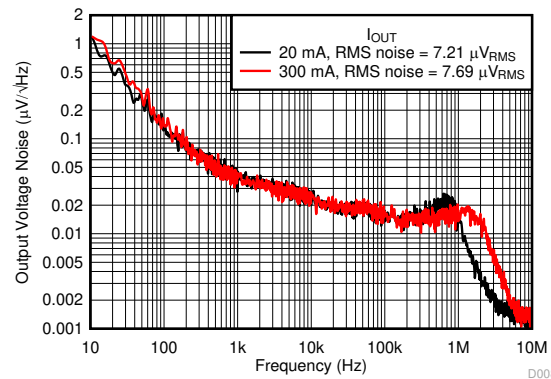

$V_{OUT} = 5.5\text{ V}$ ,  $V_{IN} = 6\text{ V}$ ,  $V_{RMS}\text{ BW} = 10\text{ Hz to }100\text{ kHz}$

图 6-72. Noise vs Frequency and  $I_{OUT}$

### 6.7 Typical Characteristics (continued)

$V_{IN} = V_{OUT(NOM)} + 0.3\text{ V}$  or  $1.6\text{ V}$  (whichever is greater),  $V_{OUT} = 2.8\text{ V}$ ,  $I_{OUT} = 1\text{ mA}$ ,  $C_{IN} = 1\text{ }\mu\text{F}$ ,  $C_{OUT} = 1\text{ }\mu\text{F}$ , and  $T_A = 25^\circ\text{C}$  (unless otherwise noted)

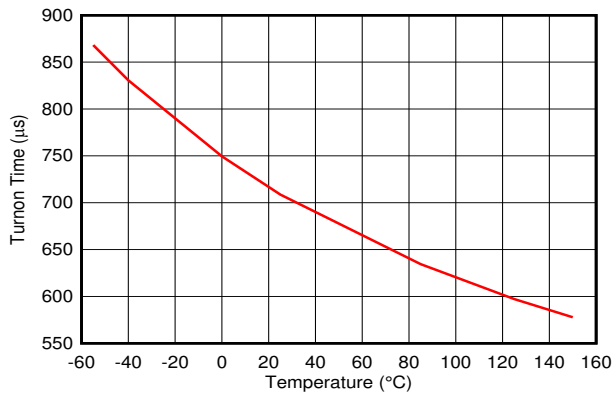

From  $V_{EN} = V_{EN(HI)}$  to  $V_{OUT} = 95\%$  of  $V_{OUT(NOM)}$ ,  $I_{OUT} = 0\text{ mA}$

图 6-73. Start-Up Turn-On Time

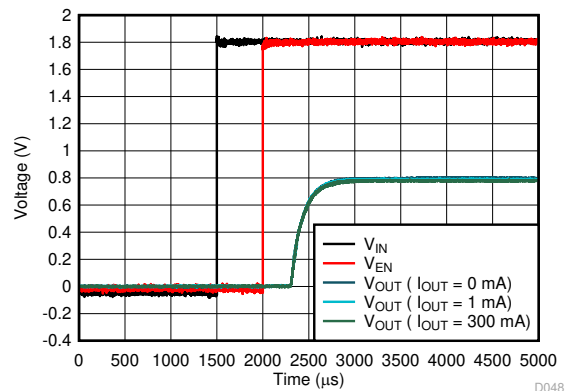

$V_{OUT} = 0.8\text{ V}$ ,  $V_{IN} = 0\text{ V}$  to  $1.8\text{ V}$ ,  $V_{EN} = 0\text{ V}$  to  $1.8\text{ V}$ ,  $V_{EN}$  rises  $500\text{ }\mu\text{s}$  behind  $V_{IN}$ ,  $V_{IN}$  and  $V_{EN}$  slew rate =  $1\text{ V}/\mu\text{s}$

图 6-74. Start-Up

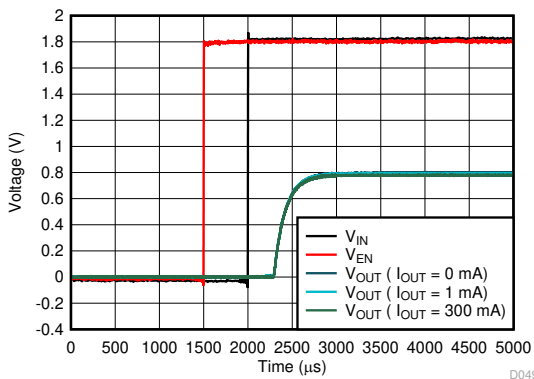

$V_{OUT} = 0.8\text{ V}$ ,  $V_{IN} = 0\text{ V}$  to  $1.8\text{ V}$ ,  $V_{EN} = 0\text{ V}$  to  $1.8\text{ V}$ ,  $V_{EN}$  rises  $500\text{ }\mu\text{s}$  ahead of  $V_{IN}$ ,  $V_{IN}$  and  $V_{EN}$  slew rate =  $1\text{ V}/\mu\text{s}$

图 6-75. Start-Up

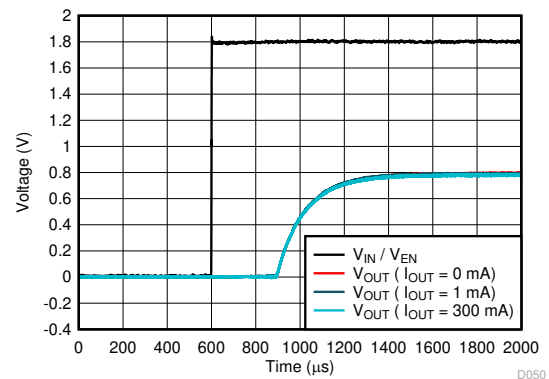

$V_{OUT} = 0.8\text{ V}$ ,  $V_{IN} = 0\text{ V}$  to  $1.8\text{ V}$ ,  $V_{EN} = V_{IN}$ ,  $V_{IN}$  slew rate =  $1\text{ V}/\mu\text{s}$

图 6-76. Start-Up

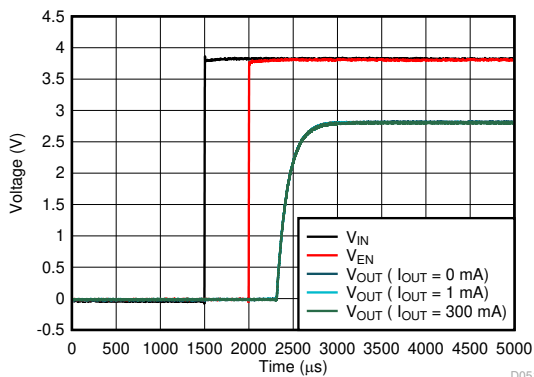

$V_{IN} = 0\text{ V}$  to  $3.8\text{ V}$ ,  $V_{EN} = 0\text{ V}$  to  $3.8\text{ V}$ ,  $V_{EN}$  rises  $500\text{ }\mu\text{s}$  behind  $V_{IN}$ ,  $V_{IN}$  and  $V_{EN}$  slew rate =  $1\text{ V}/\mu\text{s}$

图 6-77. Start-Up

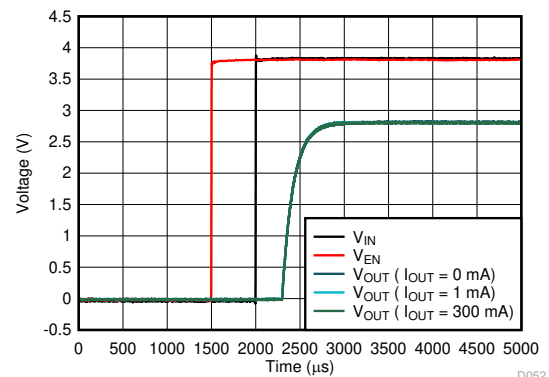

$V_{IN} = 0\text{ V}$  to  $3.8\text{ V}$ ,  $V_{EN} = 0\text{ V}$  to  $3.8\text{ V}$ ,  $V_{EN}$  rises  $500\text{ }\mu\text{s}$  ahead of  $V_{IN}$ ,  $V_{IN}$  and  $V_{EN}$  slew rate =  $1\text{ V}/\mu\text{s}$

图 6-78. Start-Up

## 6.7 Typical Characteristics (continued)

$V_{IN} = V_{OUT(NOM)} + 0.3\text{ V}$  or  $1.6\text{ V}$  (whichever is greater),  $V_{OUT} = 2.8\text{ V}$ ,  $I_{OUT} = 1\text{ mA}$ ,  $C_{IN} = 1\text{ }\mu\text{F}$ ,  $C_{OUT} = 1\text{ }\mu\text{F}$ , and  $T_A = 25^\circ\text{C}$  (unless otherwise noted)

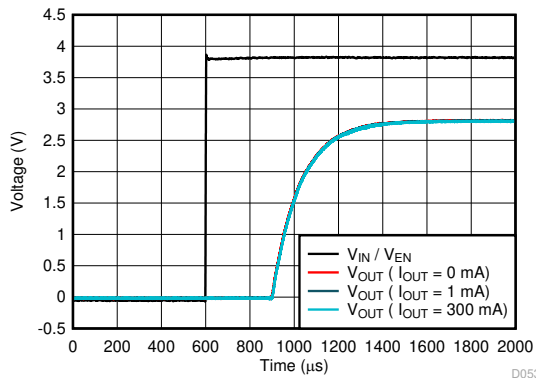

$V_{IN} = 0\text{ V}$  to  $3.8\text{ V}$ ,  $V_{EN} = 0\text{ V}$  to  $3.8\text{ V}$ ,  $V_{EN} = V_{IN}$ ,  $V_{IN}$  and slew rate =  $1\text{ V}/\mu\text{s}$

图 6-79. Start-Up

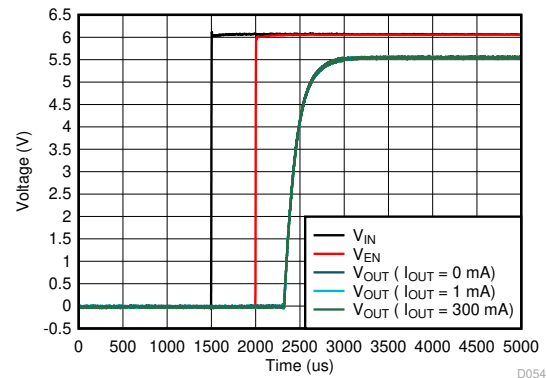

$V_{OUT} = 5.5\text{ V}$ ,  $V_{IN} = 0\text{ V}$  to  $6.0\text{ V}$ ,  $V_{EN} = 0\text{ V}$  to  $6.0\text{ V}$ ,  $V_{EN}$  rises  $500\text{ }\mu\text{s}$  behind  $V_{IN}$ ,  $V_{IN}$  and  $V_{EN}$  slew rate =  $1\text{ V}/\mu\text{s}$

图 6-80. Start-Up

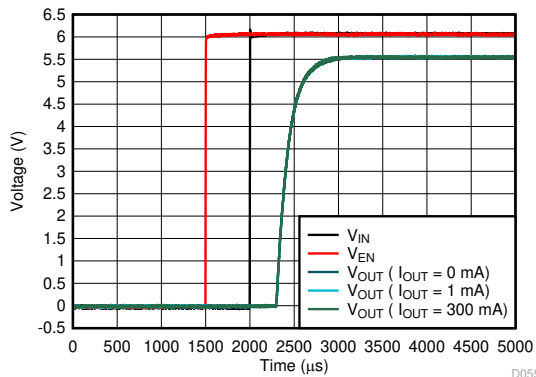

$V_{OUT} = 5.5\text{ V}$ ,  $V_{IN} = 0\text{ V}$  to  $6.0\text{ V}$ ,  $V_{EN} = 0\text{ V}$  to  $6.0\text{ V}$ ,  $V_{EN}$  rises  $500\text{ }\mu\text{s}$  ahead of  $V_{IN}$ ,  $V_{IN}$  and  $V_{EN}$  slew rate =  $1\text{ V}/\mu\text{s}$

图 6-81. Start-Up

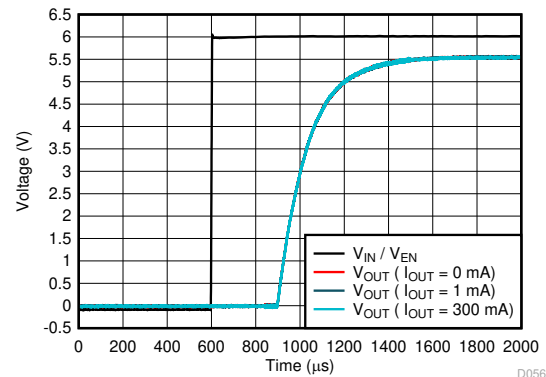

$V_{OUT} = 5.5\text{ V}$ ,  $V_{IN} = 0\text{ V}$  to  $6\text{ V}$ ,  $V_{EN} = V_{IN}$ ,  $V_{IN}$  slew rate =  $1\text{ V}/\mu\text{s}$

图 6-82. Start-Up

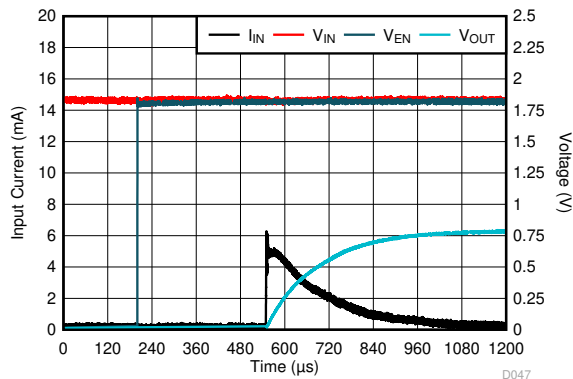

$V_{OUT} = 0.8\text{ V}$ ,  $V_{IN} = 1.8\text{ V}$ ,  $V_{EN} = 0\text{ V}$  to  $1.8\text{ V}$ ,  $V_{EN}$  slew rate =  $1\text{ V}/\mu\text{s}$ ,  $C_{OUT} = 10\text{ }\mu\text{F}$

图 6-83. Inrush Current

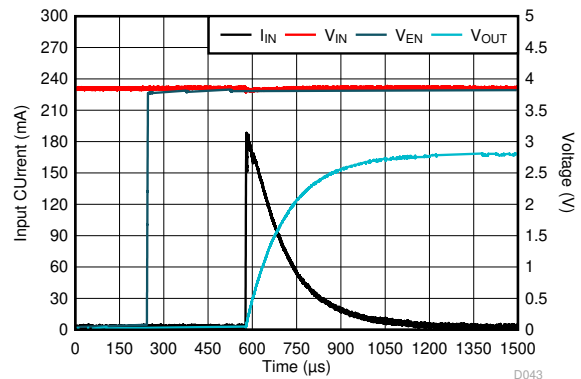

$V_{IN} = 3.8\text{ V}$ ,  $V_{EN} = 0\text{ V}$  to  $3.8\text{ V}$ ,  $V_{EN}$  slew rate =  $1\text{ V}/\mu\text{s}$ ,  $C_{OUT} = 10\text{ }\mu\text{F}$

图 6-84. Inrush Current

### 6.7 Typical Characteristics (continued)

$V_{IN} = V_{OUT(NOM)} + 0.3\text{ V}$  or  $1.6\text{ V}$  (whichever is greater),  $V_{OUT} = 2.8\text{ V}$ ,  $I_{OUT} = 1\text{ mA}$ ,  $C_{IN} = 1\text{ }\mu\text{F}$ ,  $C_{OUT} = 1\text{ }\mu\text{F}$ , and  $T_A = 25^\circ\text{C}$  (unless otherwise noted)

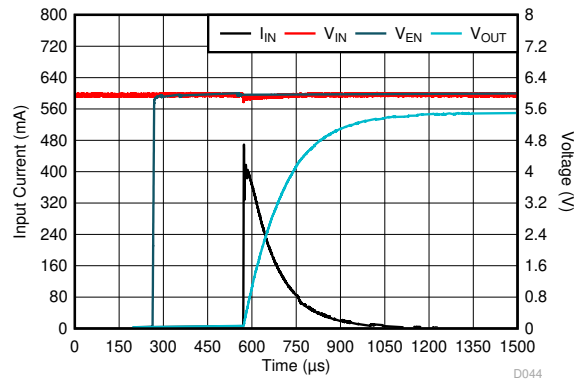

$V_{OUT} = 5.5\text{ V}$ ,  $V_{IN} = 6.0\text{ V}$ ,  $V_{EN} = 0\text{ V to }6.0\text{ V}$ ,  
 $V_{EN}$  slew rate =  $1\text{ V}/\mu\text{s}$ ,  $C_{OUT} = 10\text{ }\mu\text{F}$

图 6-85. Inrush Current

## 7 Detailed Description

### 7.1 Overview

Designed to meet the needs of sensitive RF and analog circuits, the TPS7A20 provides low noise, high PSRR, low quiescent current, as well as low line and load transient response figures. Using innovative design techniques, the TPS7A20 offers class-leading noise performance without the need for a separate noise filter capacitor.

The TPS7A20 is designed to operate with a single 1- $\mu\text{F}$  input capacitor and a single 1- $\mu\text{F}$  ceramic output capacitor.

### 7.2 Functional Block Diagram

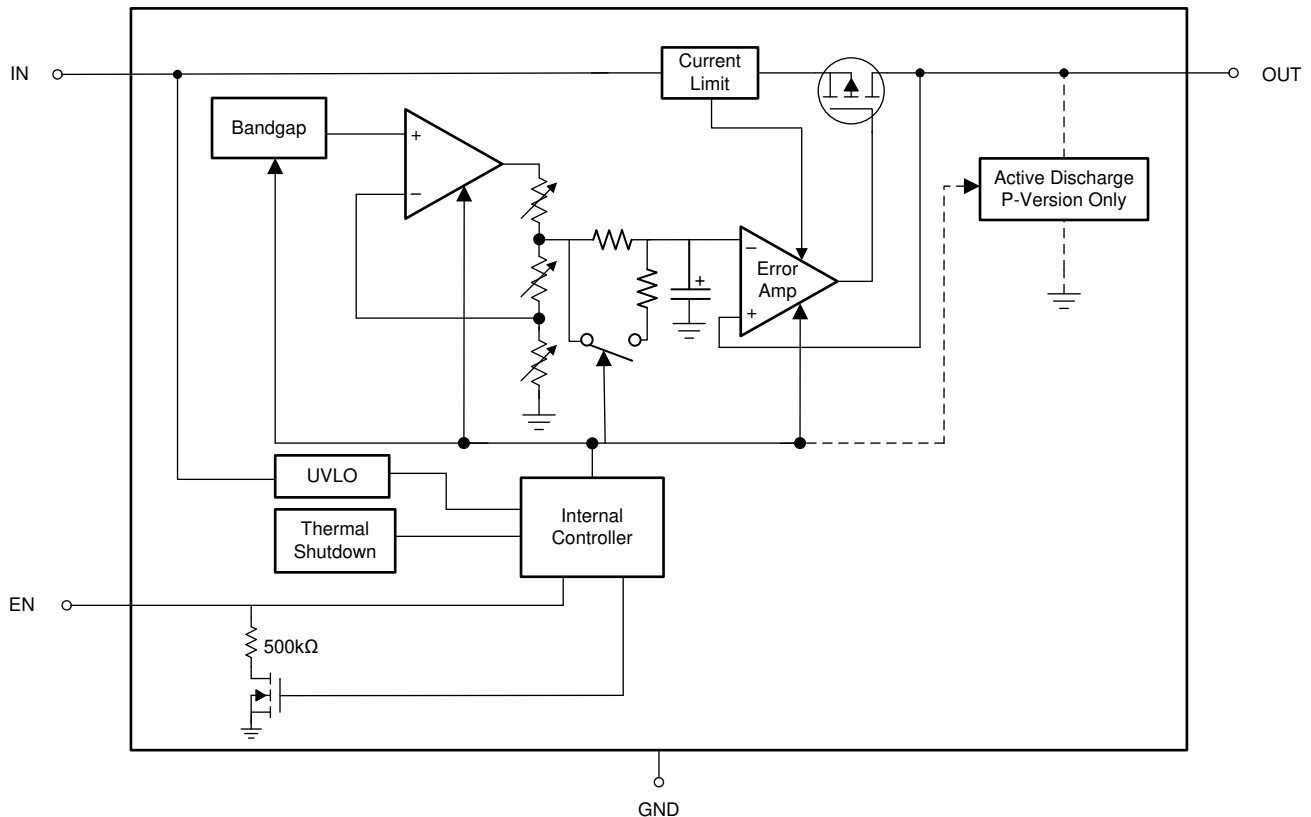

## 7.3 Feature Description

### 7.3.1 Low Output Noise

Any internal noise at the TPS7A20 reference voltage is reduced by a first-order, low-pass RC filter before being passed to the output buffer stage. The low-pass RC filter has a –3-dB cut-off frequency of approximately 0.1 Hz.

During start-up, the filter resistor is bypassed to reduce output rise time; the filter begins normal operation after the output voltage reaches the correct value.

### 7.3.2 Smart Enable

The enable (EN) input polarity is active high. The output voltage is enabled when the voltage of the enable input is greater than  $V_{EN(HI)}$  and disabled when the enable input voltage is less than  $V_{EN(LOW)}$ . If independent control of the output voltage is not needed, connect EN to IN.

This device has a smart enable circuit to reduce quiescent current. When the voltage on the enable pin is driven above  $V_{EN(HI)}$ , as listed in the *Electrical Characteristics* table, the device is enabled and the smart enable internal pulldown resistor ( $R_{EN(PULLDOWN)}$ ) is disconnected. When the enable pin is floating, the  $R_{EN(PULLDOWN)}$  is connected and pulls the enable pin low to disable the device. The  $R_{EN(PULLDOWN)}$  value is listed in the *Electrical Characteristics* table.

### 7.3.3 Dropout Voltage

Dropout voltage ( $V_{DO}$ ) is defined as the input voltage minus the output voltage ( $V_{IN} - V_{OUT}$ ) at the rated output current ( $I_{RATED}$ ), where the pass transistor is fully on.  $I_{RATED}$  is the maximum  $I_{OUT}$  listed in the *Recommended Operating Conditions* table. The pass transistor is in the ohmic or triode region of operation, and acts as a switch. The dropout voltage indirectly specifies a minimum input voltage greater than the nominal programmed output voltage at which the output voltage is expected to stay in regulation. If the input voltage falls to less than the value required to maintain output regulation, then the output voltage falls as well.

For a CMOS regulator, the dropout voltage is determined by the drain-source on-state resistance ( $R_{DS(ON)}$ ) of the pass transistor. Therefore, if the linear regulator operates at less than the rated current, the dropout voltage for that current scales accordingly. The following equation calculates the  $R_{DS(ON)}$  of the device.

$$R_{DS(ON)} = \frac{V_{DO}}{I_{RATED}} \quad (1)$$

### 7.3.4 Foldback Current Limit

The device has an internal current limit circuit that protects the regulator during transient high-load current faults or shorting events. The current limit is a hybrid brickwall-foldback scheme. The current limit transitions from a brickwall scheme to a foldback scheme at the foldback voltage ( $V_{FOLDBACK}$ ). In a high-load current fault with the output voltage above  $V_{FOLDBACK}$ , the brickwall scheme limits the output current to the current limit ( $I_{CL}$ ). When the voltage drops below  $V_{FOLDBACK}$ , a foldback current limit activates that scales back the current as the output voltage approaches GND. When the output is shorted, the device supplies a typical current called the short-circuit current limit ( $I_{SC}$ ).  $I_{CL}$  and  $I_{SC}$  are listed in the *Electrical Characteristics* table.

The output voltage is not regulated when the device is in current limit. When a current limit event occurs, the device begins to heat up because of the increase in power dissipation. When the device is in brickwall current limit, the pass transistor dissipates power  $[(V_{IN} - V_{OUT}) \times I_{CL}]$ . When the device output is shorted and the output is below  $V_{FOLDBACK}$ , the pass transistor dissipates power  $[(V_{IN} - V_{OUT}) \times I_{SC}]$ . If thermal shutdown is triggered, the device turns off. After the device cools down, the internal thermal shutdown circuit turns the device back on. If the output current fault condition continues, the device cycles between current limit and thermal shutdown. For more information on current limits, see the [Know Your Limits application report](#).



图 7-1 shows a diagram of the foldback current limit.



图 7-1. Foldback Current Limit

### 7.3.5 Undervoltage Lockout (UVLO)

The device has an independent undervoltage lockout (UVLO) circuit that monitors the input voltage, allowing a controlled and consistent turn on and off of the output voltage. To prevent the device from turning off if the input drops during turn on, the UVLO has hysteresis as specified in the *Electrical Characteristics* table.

### 7.3.6 Thermal Shutdown

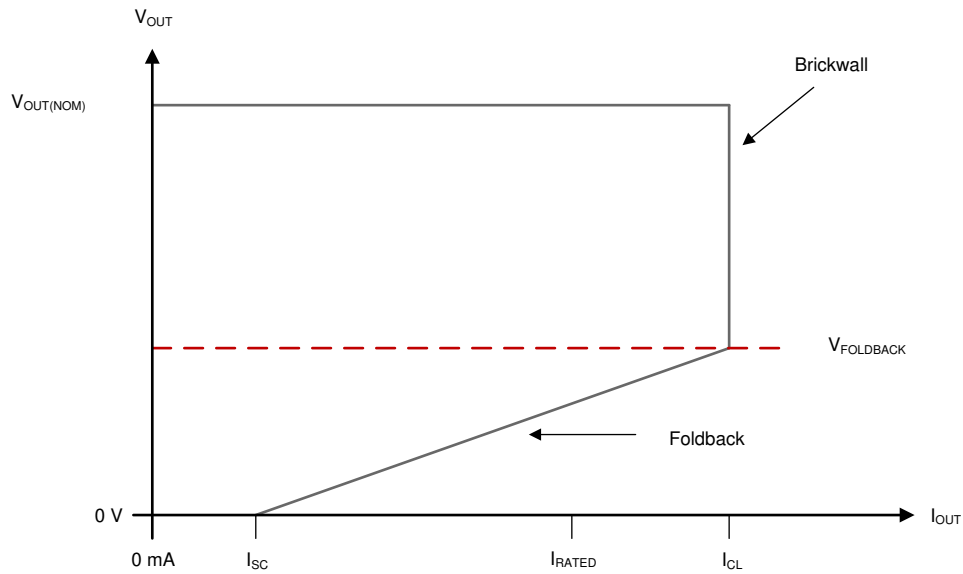
A thermal shutdown protection circuit disables the LDO when the junction temperature ( $T_J$ ) of the pass transistor rises to  $T_{SD(shutdown)}$  (typical). Thermal shutdown hysteresis assures that the device resets (turns on) when the temperature falls to  $T_{SD(reset)}$  (typical).

The thermal time-constant of the semiconductor die is fairly short, thus the device may cycle on and off when thermal shutdown is reached until power dissipation is reduced. Power dissipation during startup can be high from large  $V_{IN} - V_{OUT}$  voltage drops across the device or from high inrush currents charging large output capacitors. Under some conditions, the thermal shutdown protection disables the device before startup completes.

For reliable operation, limit the junction temperature to the maximum listed in the *Recommended Operating Conditions* table. Operation above this maximum temperature causes the device to exceed its operational specifications. Although the internal protection circuitry of the device is designed to protect against thermal overload conditions, this circuitry is not intended to replace proper heat sinking. Continuously running the device into thermal shutdown or above the maximum recommended junction temperature reduces long-term reliability.

### 7.3.7 Active Discharge

An internal pulldown MOSFET connects a resistor from OUT to ground when the device is disabled to actively discharge the output capacitance. The active discharge circuit is activated by driving EN low or by the voltage on IN falling below the undervoltage lockout (UVLO) threshold.

Do not rely on the active discharge circuit for discharging a large amount of output capacitance after the input supply has collapsed because reverse current can possibly flow from the output to the input. This reverse current flow can cause damage to the device. Limit reverse current to no more than 5% of the device rated current for a short period of time.

## 7.4 Device Functional Modes

### 7.4.1 Device Functional Mode Comparison

表 7-1 shows the conditions that lead to the different modes of operation. See the *Electrical Characteristics* table for parameter values.

表 7-1. Device Functional Mode Comparison

| OPERATING MODE                                       | PARAMETER   |                        |                          |                          |
|--|---|------------------------|--------------------------|--------------------------|
|  | $V_{IN}$  | $V_{EN}$               | $I_{OUT}$                | $T_J$                    |
| Normal operation                                     | $V_{IN} > V_{OUT(nom)} + V_{DO}$ and $V_{IN} > V_{IN(min)}$ | $V_{EN} > V_{EN(HI)}$  | $I_{OUT} < I_{OUT(max)}$ | $T_J < T_{SD(shutdown)}$ |
| Dropout operation                                    | $V_{IN(min)} < V_{IN} < V_{OUT(nom)} + V_{DO}$              | $V_{EN} > V_{EN(HI)}$  | $I_{OUT} < I_{OUT(max)}$ | $T_J < T_{SD(shutdown)}$ |
| Disabled<br>(any true condition disables the device) | $V_{IN} < V_{UVLO}$   | $V_{EN} < V_{EN(LOW)}$ | Not applicable           | $T_J > T_{SD(shutdown)}$ |

### 7.4.2 Normal Operation

The device regulates to the nominal output voltage when the following conditions are met:

- The input voltage is greater than the nominal output voltage plus the dropout voltage ( $V_{OUT(nom)} + V_{DO}$ )
- The output current is less than the current limit ( $I_{OUT} < I_{CL}$ )
- The device junction temperature is less than the thermal shutdown temperature ( $T_J < T_{SD}$ )
- The enable voltage has previously exceeded the enable rising threshold voltage and has not yet decreased to less than the enable falling threshold

### 7.4.3 Dropout Operation

If the input voltage is lower than the nominal output voltage plus the specified dropout voltage, but all other conditions are met for normal operation, the device operates in dropout mode. In this mode, the output voltage tracks the input voltage. During this mode, the transient performance of the device becomes significantly degraded because the pass transistor is in the ohmic or triode region, and acts as a switch. Line or load transients in dropout can result in large output-voltage deviations.

When the device is in a steady dropout state (defined as when the device is in dropout,  $V_{IN} < V_{OUT(NOM)} + V_{DO}$ , directly after being in a normal regulation state, but *not* during startup), the pass transistor is driven into the ohmic or triode region. When the input voltage returns to a value greater than or equal to the nominal output voltage plus the dropout voltage ( $V_{OUT(NOM)} + V_{DO}$ ), the output voltage can overshoot for a short period of time while the device pulls the pass transistor back into the linear region.

### 7.4.4 Disabled

The output of the LDO can be shut down by driving EN to less than  $V_{EN(LOW)}$  (see the *Electrical Characteristics* table). When disabled, the pass transistor is turned off, internal circuits are shut down, and the output voltage is actively discharged to ground by an internal discharge circuit between OUT and ground.

## 8 Application and Implementation

### 备注

以下应用部分中的信息不属于 TI 器件规格的范围，TI 不担保其准确性和完整性。TI 的客户应负责确定器件是否适用于其应用。客户应验证并测试其设计，以确保系统功能。

### 8.1 Application Information

#### 8.1.1 Recommended Capacitor Types

The device is designed to be stable using low equivalent series resistance (ESR) ceramic capacitors at the input and output. Multilayer ceramic capacitors have become the industry standard for these types of applications and are recommended, but must be used with good judgment. Ceramic capacitors that employ X7R-, X5R-, and C0G-rated dielectric materials provide relatively good capacitive stability across temperature, whereas the use of Y5V-rated capacitors is discouraged because of large variations in capacitance.

Regardless of the ceramic capacitor type selected, the effective capacitance varies with operating voltage and temperature. As a rule of thumb, expect the effective capacitance to decrease by as much as 50%. The input and output capacitors recommended in the *Recommended Operating Conditions* table account for an effective capacitance of approximately 50% of the nominal value.

#### 8.1.2 Input and Output Capacitor Requirements

Although the LDO itself is stable without an input capacitor, good analog design practice is to connect a capacitor from IN to GND, with a value at least equal to the nominal value specified in the *Recommended Operating Conditions* table. The input capacitor counteracts reactive input sources and improves transient response, input ripple, and PSRR, and is recommended if the source impedance is greater than  $0.5 \Omega$ . When the source resistance and inductance are sufficiently high, especially in the presence of load transients, the overall system may be susceptible to instability (including ringing and sustained oscillation) and other performance degradation if there is insufficient capacitance between IN and GND. A capacitor with a value greater than the minimum may be necessary if large, fast-rise-time load or line transients are anticipated or if the device is located more than a few centimeters from the input power source.

An output capacitor of an appropriate value helps ensure stability and improve dynamic performance. Use an output capacitor within the range specified in the *Recommended Operating Conditions* table.

#### 8.1.3 Load Transient Response

The load-step transient response is the output voltage response by the LDO to a step in load current, whereby output voltage regulation is maintained. There are two key transitions during a load transient response: the transition from a light to a heavy load and the transition from a heavy to a light load. The regions shown in 图 8-1 are broken down as follows. Regions A, E, and H are where the output voltage is in steady-state.



图 8-1. Load Transient Waveform

During transitions from a light load to a heavy load, the:

- Initial voltage dip is a result of the depletion of the output capacitor charge and parasitic impedance to the output capacitor (region B)
- Recovery from the dip results from the LDO increasing its sourcing current, and leads to output voltage regulation (region C)

During transitions from a heavy load to a light load, the:

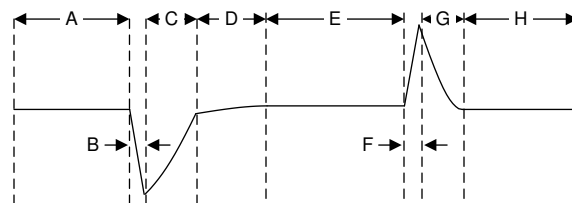
- Initial voltage rise results from the LDO sourcing a large current, and leads to the output capacitor charge to increase (region F)
- Recovery from the rise results from the LDO decreasing its sourcing current in combination with the load discharging the output capacitor (region G)

A larger output capacitance reduces the peaks during a load transient but slows down the response time of the device. A larger DC load also reduces the peaks because the amplitude of the transition is lowered and a higher current discharge path is provided for the output capacitor.

### 8.1.4 Undervoltage Lockout (UVLO) Operation

The UVLO circuit ensures that the device stays disabled before its input supply reaches the minimum operational voltage range, and ensures that the device shuts down when the input supply collapses. 图 8-2 shows the UVLO circuit response to various input voltage events. The diagram can be separated into the following parts:

- Region A: The device does not start until the input reaches the UVLO rising threshold.
- Region B: Normal operation, regulating device.
- Region C: Brownout event above the UVLO falling threshold (UVLO rising threshold – UVLO hysteresis). The output may fall out of regulation but the device remains enabled.
- Region D: Normal operation, regulating device.
- Region E: Brownout event below the UVLO falling threshold. The device is disabled in most cases and the output falls because of the load and active discharge circuit. The device is re-enabled when the UVLO rising threshold is reached by the input voltage and a normal start-up follows.
- Region F: Normal operation followed by the input falling to the UVLO falling threshold.
- Region G: The device is disabled when the input voltage falls below the UVLO falling threshold to 0 V. The output falls because of the load and active discharge circuit.



图 8-2. Typical UVLO Operation

### 8.1.5 Power Dissipation ( $P_D$ )

Circuit reliability demands that proper consideration be given to device power dissipation, location of the circuit on the printed circuit board (PCB), and correct sizing of the thermal plane. The PCB area around the regulator must be as free as possible of other heat-generating devices that cause added thermal stresses.

As a first-order approximation, power dissipation in the regulator depends on the input-to-output voltage difference and load conditions. Use 方程式 2 to approximate  $P_D$ :

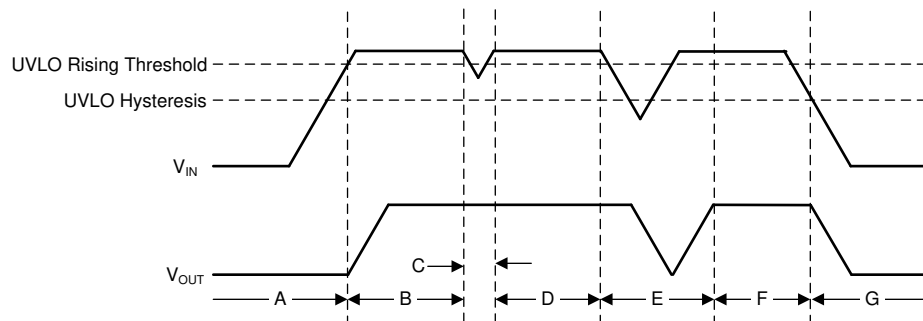
$$P_D = (V_{IN} - V_{OUT}) \times I_{OUT} \quad (2)$$

Power dissipation can be minimized, and thus greater efficiency achieved, by proper selection of the system voltage rails. Proper selection allows the minimum input-to-output voltage differential to be obtained. The low dropout of the TPS7A20 allows for maximum efficiency across a wide range of output voltages.

The main heat conduction path for the device is through the thermal pad on the package. As such, the thermal pad must be soldered to a copper pad area under the device. This pad area contains an array of plated vias that conduct heat to any inner plane areas or to a bottom-side copper plane.

The maximum power dissipation determines the maximum allowable junction temperature ( $T_J$ ) for the device. According to 方程式 3, power dissipation and junction temperature are most often related by the junction-to-ambient thermal resistance ( $R_{\theta JA}$ ) of the combined PCB and device package and the temperature of the ambient air ( $T_A$ ). 方程式 4 rearranges 方程式 3 for output current.

$$T_J = T_A + (R_{\theta JA} \times P_D) \quad (3)$$

$$I_{OUT} = (T_J - T_A) / [R_{\theta JA} \times (V_{IN} - V_{OUT})] \quad (4)$$

Unfortunately, this thermal resistance ( $R_{\theta JA}$ ) is highly dependent on the heat-spreading capability built into the particular PCB design, and therefore varies according to the total copper area, copper weight, and location of the planes. The  $R_{\theta JA}$  recorded in the *Thermal Information* table is determined by the JEDEC standard, PCB, and copper-spreading area, and is only used as a relative measure of package thermal performance. For a well-designed thermal layout,  $R_{\theta JA}$  is actually the sum of the X2SON package junction-to-case (bottom) thermal resistance ( $R_{\theta JC(bot)}$ ) plus the thermal resistance contribution by the PCB copper.

### 8.1.5.1 Estimating Junction Temperature

The JEDEC standard now recommends the use of psi ( $\Psi$ ) thermal metrics to estimate the junction temperatures of the LDO when in-circuit on a typical PCB board application. These metrics are not strictly speaking thermal resistances, but rather offer practical and relative means of estimating junction temperatures. These psi metrics are determined to be significantly independent of the copper-spreading area. The key thermal metrics ( $\Psi_{JT}$  and  $\Psi_{JB}$ ) are used in accordance with 方程式 5 and are given in the *Thermal Information* table.

$$\Psi_{JT} : T_J = T_T + \Psi_{JT} \times P_D \text{ and } \Psi_{JB} : T_J = T_B + \Psi_{JB} \times P_D \quad (5)$$

where:

- $P_D$  is the power dissipated as explained in 方程式 2
- $T_T$  is the temperature at the center-top of the device package
- $T_B$  is the PCB surface temperature measured 1 mm from the device package and centered on the package edge

### 8.1.5.2 Recommended Area for Continuous Operation

The operational area of an LDO is limited by the dropout voltage, output current, junction temperature, and input voltage. The recommended area for continuous operation for a linear regulator is given in 图 8-3 and can be separated into the following parts:

- Dropout voltage limits the minimum differential voltage between the input and the output ( $V_{IN} - V_{OUT}$ ) at a given output current level. See the *Dropout Operation* section for more details.
- The rated output currents limits the maximum recommended output current level. Exceeding this rating causes the device to fall out of specification.
- The rated junction temperature limits the maximum junction temperature of the device. Exceeding this rating causes the device to fall out of specification and reduces long-term reliability.
  - The shape of the slope is given by 方程式 4. The slope is nonlinear because the maximum-rated junction temperature of the LDO is controlled by the power dissipation across the LDO; thus when  $V_{IN} - V_{OUT}$  increases the output current must decrease.
- The rated input voltage range governs both the minimum and maximum of  $V_{IN} - V_{OUT}$ .

图 8-3 shows the recommended area of operation for this device on a JEDEC-standard high-K board with a  $R_{\theta JA}$  as given in the *Thermal Information* table.



图 8-3. Region Description of Continuous Operation Regime

## 8.2 Typical Application

图 8-4 shows the typical application circuit for the TPS7A20. Input and output capacitances may need to be increased above the 1  $\mu\text{F}$  minimum for some applications.

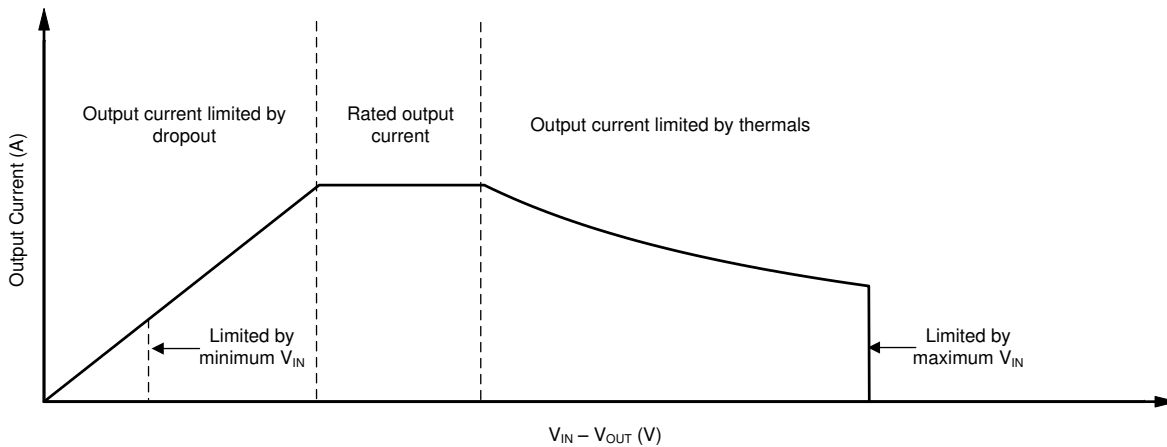
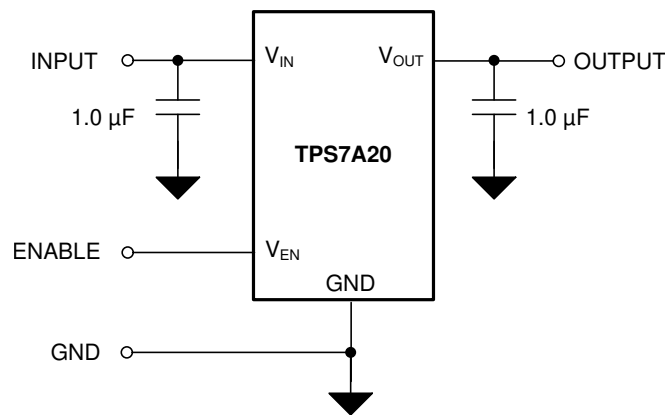

SVA-30180501

图 8-4. TPS7A20 Typical Application

### 8.2.1 Design Requirements

表 8-1 summarizes the design requirements for 图 8-4.

表 8-1. Design Parameters

| DESIGN PARAMETER            | EXAMPLE VALUE  |
|-----------------------------|----------------|
| Input voltage range         | 3.1 V to 3.6 V |
| Output voltage              | 2.8 V          |
| Output current              | 200 mA         |
| Maximum ambient temperature | 85°C           |

### 8.2.2 Detailed Design Procedure

For this design example, the 2.8-V output version (TPS7A2028) is selected. A nominal 3.3-V input supply is assumed. A minimum 1.0- $\mu\text{F}$  input capacitor is recommended to minimize the effect of resistance and inductance between the 3.3-V source and the LDO input. A minimum 1.0- $\mu\text{F}$  output capacitor is also

recommended for stability and good load transient response. The dropout voltage ( $V_{DO}$ ) is less than 140 mV maximum at a 2.8-V output voltage and 300-mA output current, so there are no dropout issues with a minimum input voltage of 3.0 V and a maximum output current of 200 mA.

### 8.2.3 Application Curves

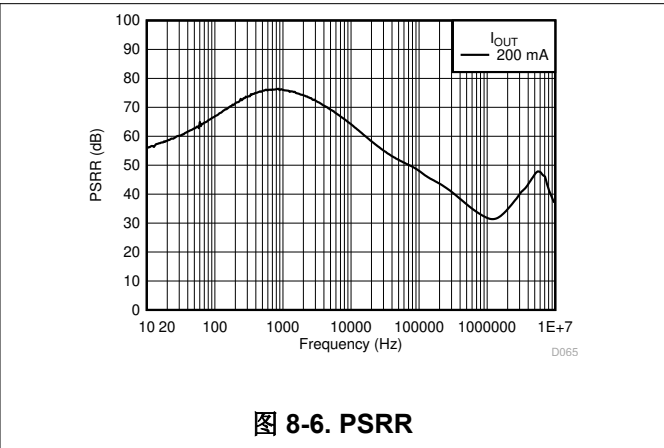
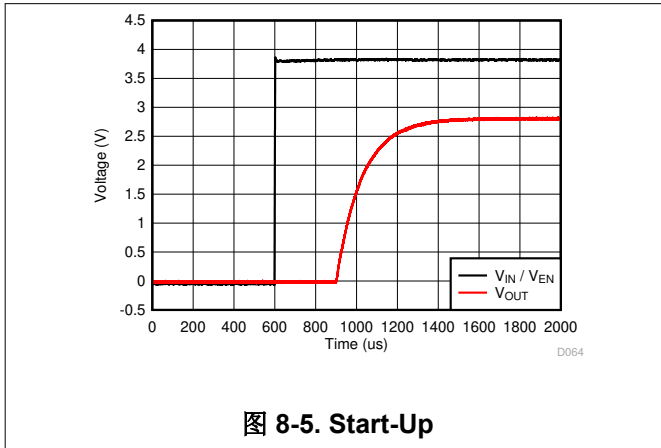

## 9 Power Supply Recommendations

This device is designed to operate from an input supply voltage range of 1.6 V to 6.0 V. The input supply must be well regulated and free of spurious noise. To ensure that the output voltage is well regulated and dynamic performance is optimum, the input supply must be at least  $V_{OUT(nom)} + 0.3$  V or 1.6 V, whichever is greater. TI highly recommends using a 1- $\mu$ F or greater input capacitor to reduce the impedance of the input supply, especially during transients.

## 10 Layout

### 10.1 Layout Guidelines

- Place input and output capacitors as close to the device as possible.
- Use copper planes for device connections to optimize thermal performance.
- Place thermal vias around the device to distribute the heat.
- Do not place a thermal via directly beneath the thermal pad of the DQN package. A via can wick solder or solder paste away from the thermal pad joint during the soldering process, leading to a compromised solder joint on the thermal pad.

### 10.2 Layout Examples



图 10-1. DBV Package (SOT-23) Typical Layout



图 10-2. DQN Package (X2SON) Typical Layout

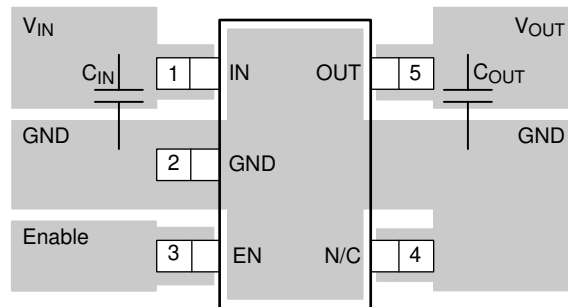

图 10-3. YCJ and YCK Package (DSBGA) Typical Layout

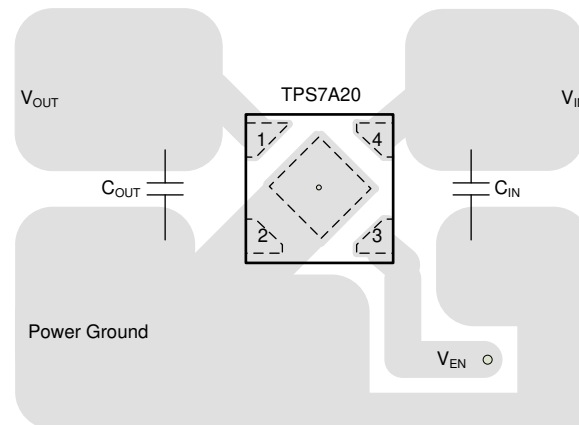

## 11 Device and Documentation Support

### 11.1 Device Support

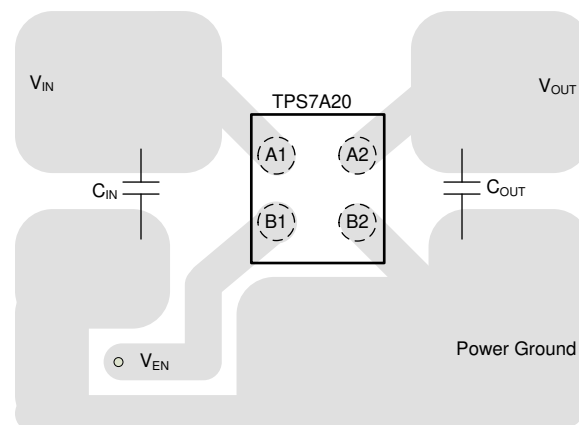
#### 11.1.1 Device Nomenclature

表 11-1. Device Nomenclature

| PRODUCT <sup>(1) (2)</sup> | V <sub>OUT</sub>  |
|----------------------------|---|
| TPS7A20xx(x)Pyyyz          | <p><b>xx(x)</b> is the nominal output voltage. For output voltages with a resolution of 100 mV, two digits are used in the ordering number; otherwise, three digits are used (for example, 28 = 2.8 V; 125 = 1.25 V).</p> <p><b>P</b> indicates an active output discharge feature. All members of the TPS7A20 family actively discharge the output when the device is disabled.</p> <p><b>yyy</b> is the package designator.</p> <p><b>z</b> is the package quantity. R is for reel (3000 pieces for DQN and DBV; 12000 pieces for YCJ and YCK).</p> |

- (1) For the most current package and ordering information see the Package Option Addendum at the end of this document, or visit the device product folder on [www.ti.com](http://www.ti.com).
- (2) Output voltages from 0.8 V to 5.5 V in 25-mV increments are available. Contact the factory for details and availability.

### 11.2 接收文档更新通知

要接收文档更新通知，请导航至 [ti.com](http://ti.com) 上的器件产品文件夹。点击 [订阅更新](#) 进行注册，即可每周接收产品信息更改摘要。有关更改的详细信息，请查看任何已修订文档中包含的修订历史记录。

### 11.3 支持资源

**TI E2E™ 支持论坛** 是工程师的重要参考资料，可直接从专家获得快速、经过验证的解答和设计帮助。搜索现有解答或提出自己的问题可获得所需的快速设计帮助。

链接的内容由各个贡献者“按原样”提供。这些内容并不构成 TI 技术规范，并且不一定反映 TI 的观点；请参阅 TI 的《[使用条款](#)》。

### 11.4 Trademarks

TI E2E™ is a trademark of Texas Instruments.

所有商标均为其各自所有者的财产。

### 11.5 Electrostatic Discharge Caution



This integrated circuit can be damaged by ESD. Texas Instruments recommends that all integrated circuits be handled with appropriate precautions. Failure to observe proper handling and installation procedures can cause damage.

ESD damage can range from subtle performance degradation to complete device failure. Precision integrated circuits may be more susceptible to damage because very small parametric changes could cause the device not to meet its published specifications.

### 11.6 术语表

**TI 术语表** 本术语表列出并解释了术语、首字母缩略词和定义。

## 12 Mechanical, Packaging, and Orderable Information

The following pages include mechanical, packaging, and orderable information. This information is the most current data available for the designated devices. This data is subject to change without notice and revision of this document. For browser-based versions of this data sheet, refer to the left-hand navigation.

## 12.1 Mechanical Data



### PACKAGE OUTLINE

YCJ0004-C02

DSBGA - 0.35 mm max height

DIE SIZE BALL GRID ARRAY

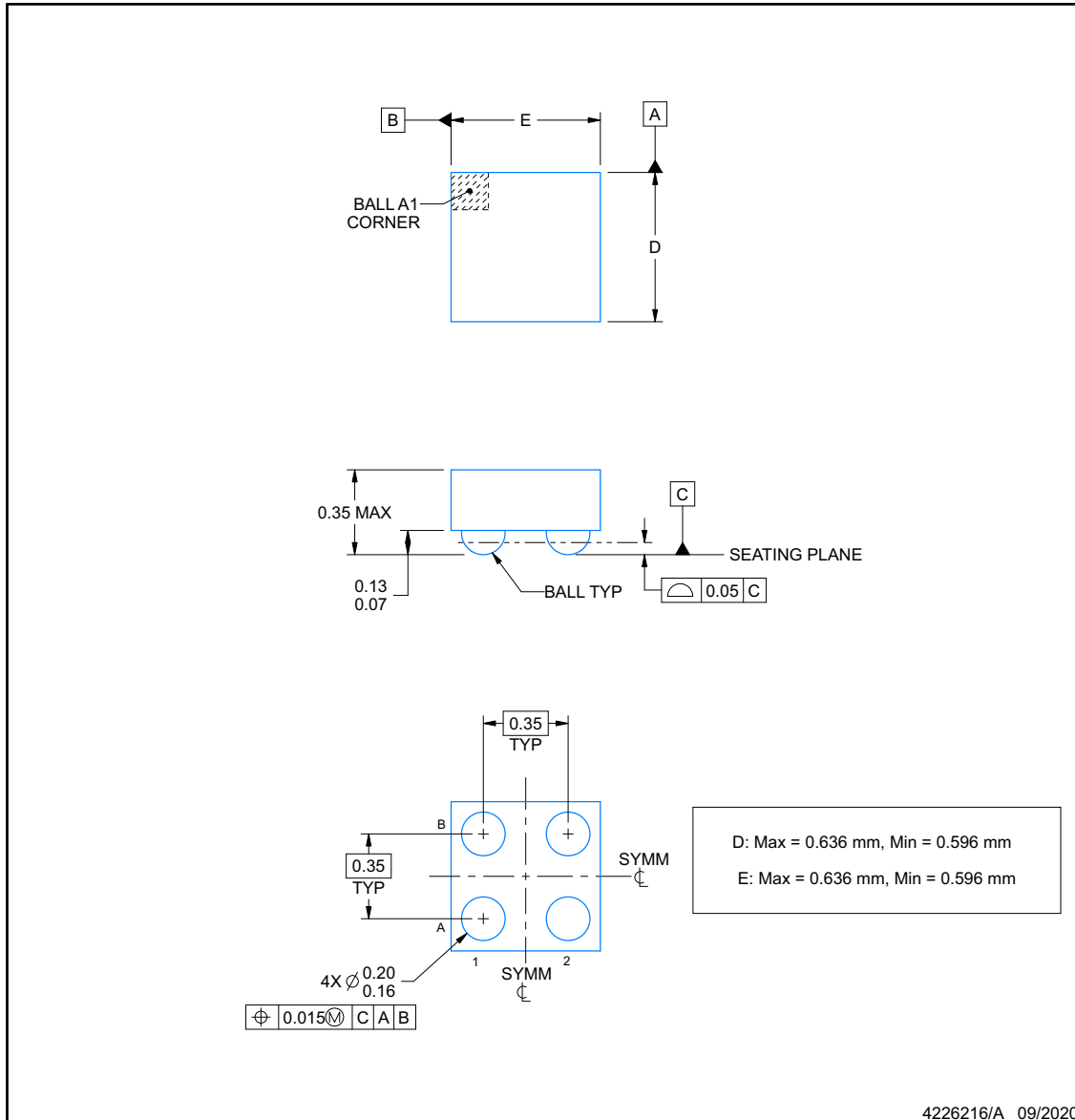

NOTES:

1. All linear dimensions are in millimeters. Any dimensions in parenthesis are for reference only. Dimensioning and tolerancing per ASME Y14.5M.
2. This drawing is subject to change without notice.

## EXAMPLE BOARD LAYOUT

**YCJ0004-C02**

**DSBGA - 0.35 mm max height**

DIE SIZE BALL GRID ARRAY

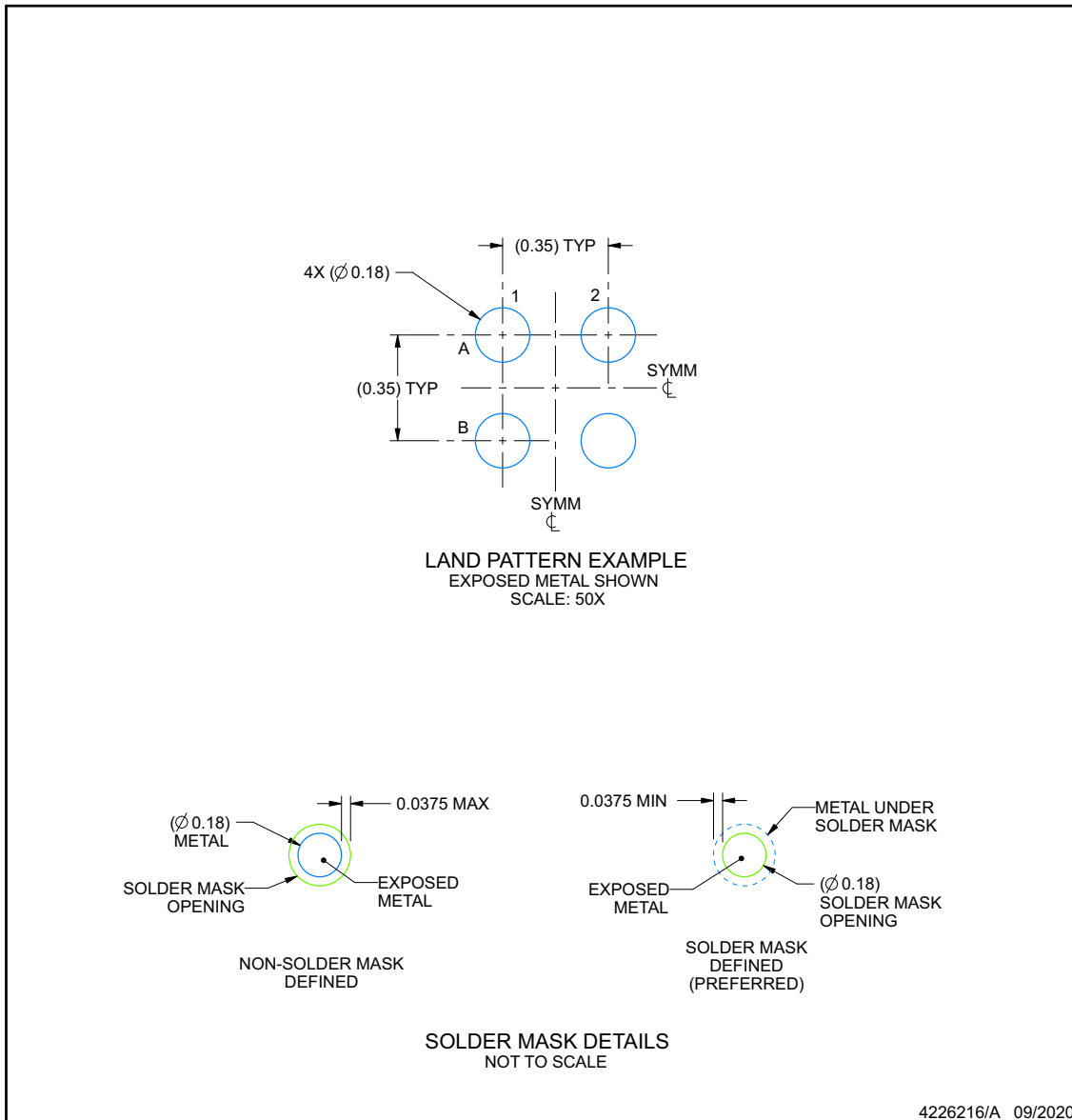

NOTES: (continued)

- Final dimensions may vary due to manufacturing tolerance considerations and also routing constraints. See Texas Instruments Literature No. SNVA009 ([www.ti.com/lit/snva009](http://www.ti.com/lit/snva009)).

## EXAMPLE STENCIL DESIGN

**YCJ0004-C02**

**DSBGA - 0.35 mm max height**

DIE SIZE BALL GRID ARRAY

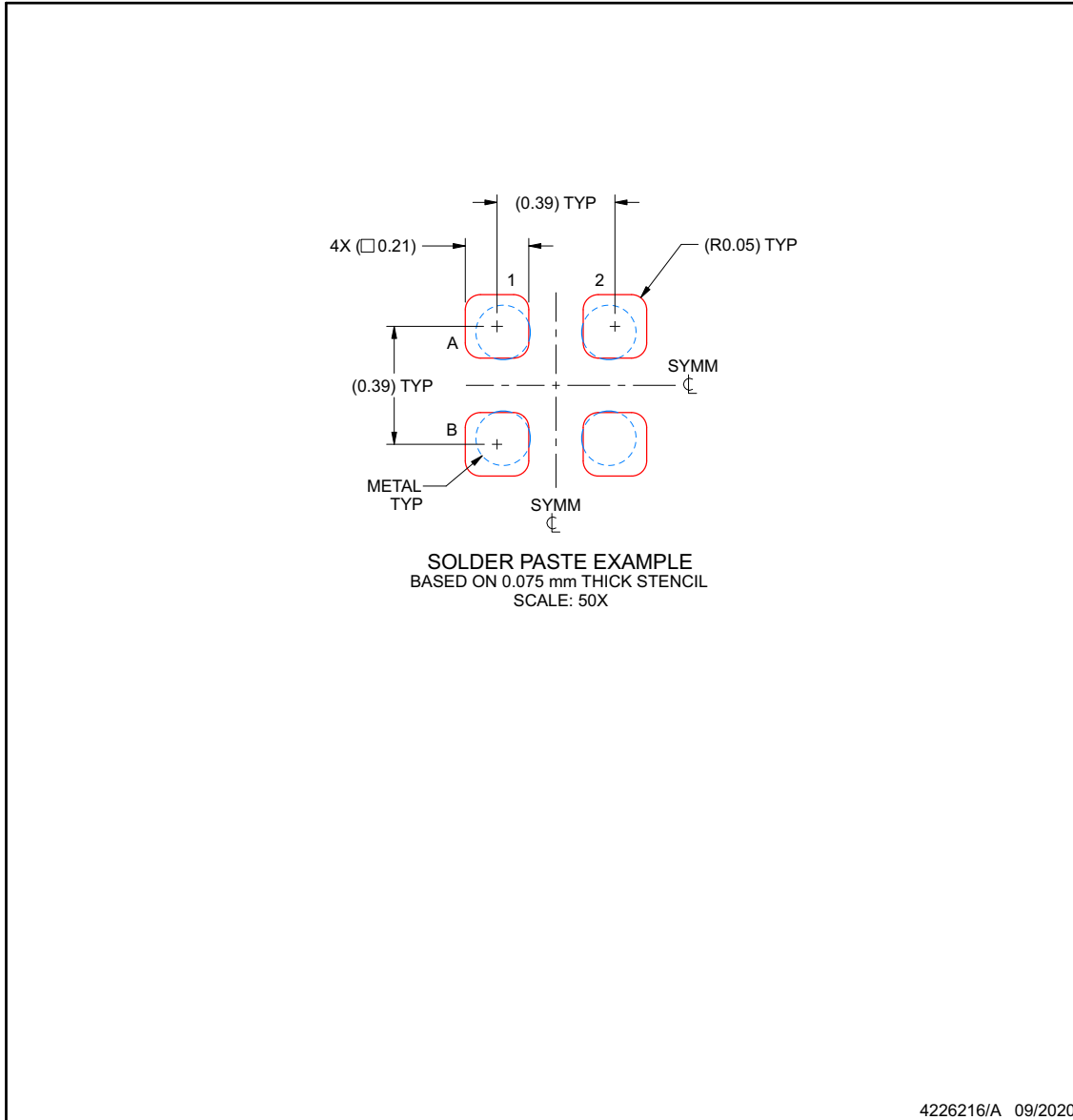

NOTES: (continued)

4. Laser cutting apertures with trapezoidal walls and rounded corners may offer better paste release.



## PACKAGE OUTLINE

YCK0004-C01

DSBGA - 0.33mm MAX HEIGHT

DIE SIZE BALL GRID ARRAY

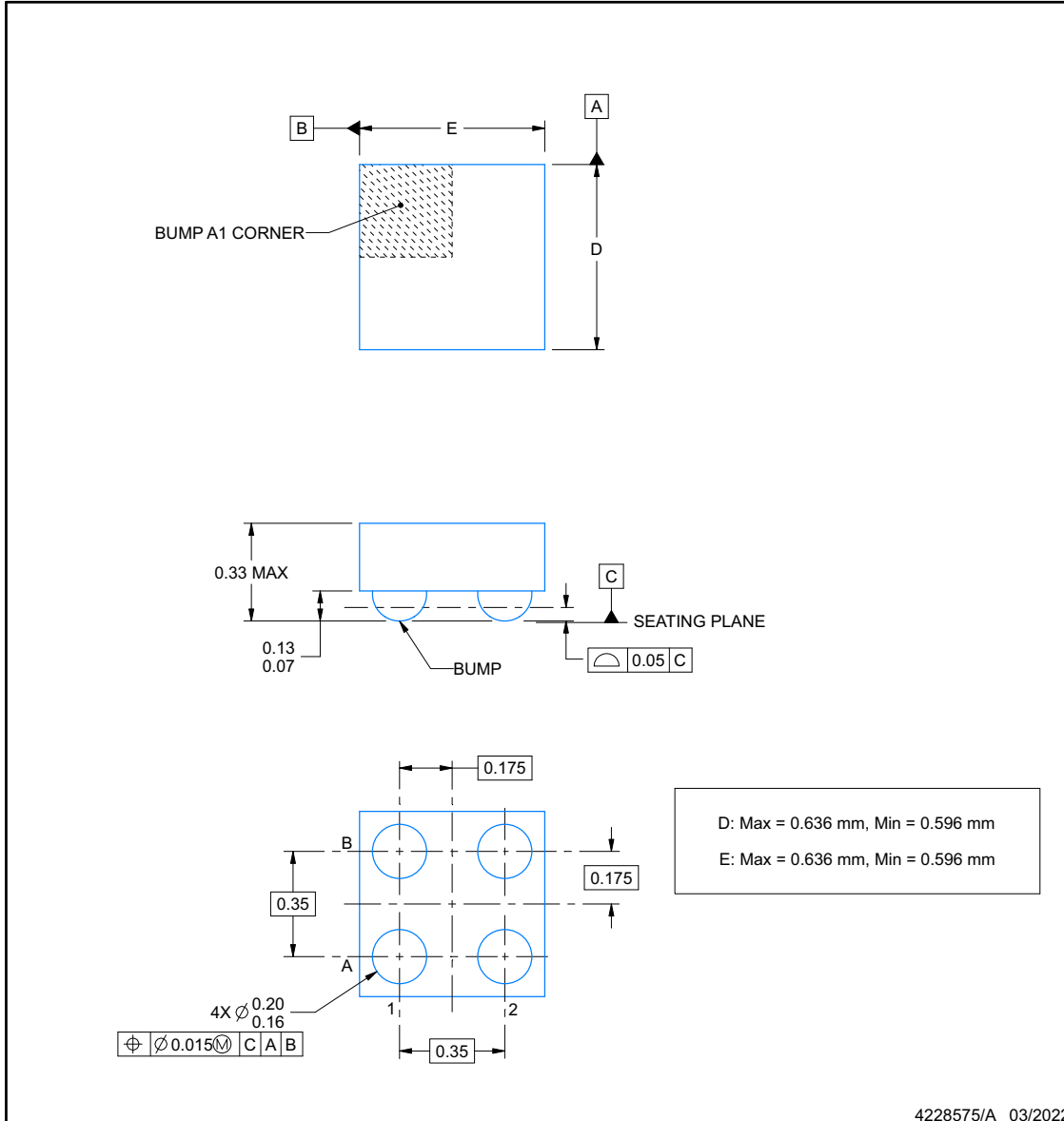

NOTES:

1. All linear dimensions are in millimeters. Dimensions in parenthesis are for reference only. Dimensioning and tolerancing per ASME Y14.5M.
2. This drawing is subject to change without notice.

## EXAMPLE BOARD LAYOUT

YCK0004-C01

DSBGA - 0.33mm MAX HEIGHT

DIE SIZE BALL GRID ARRAY

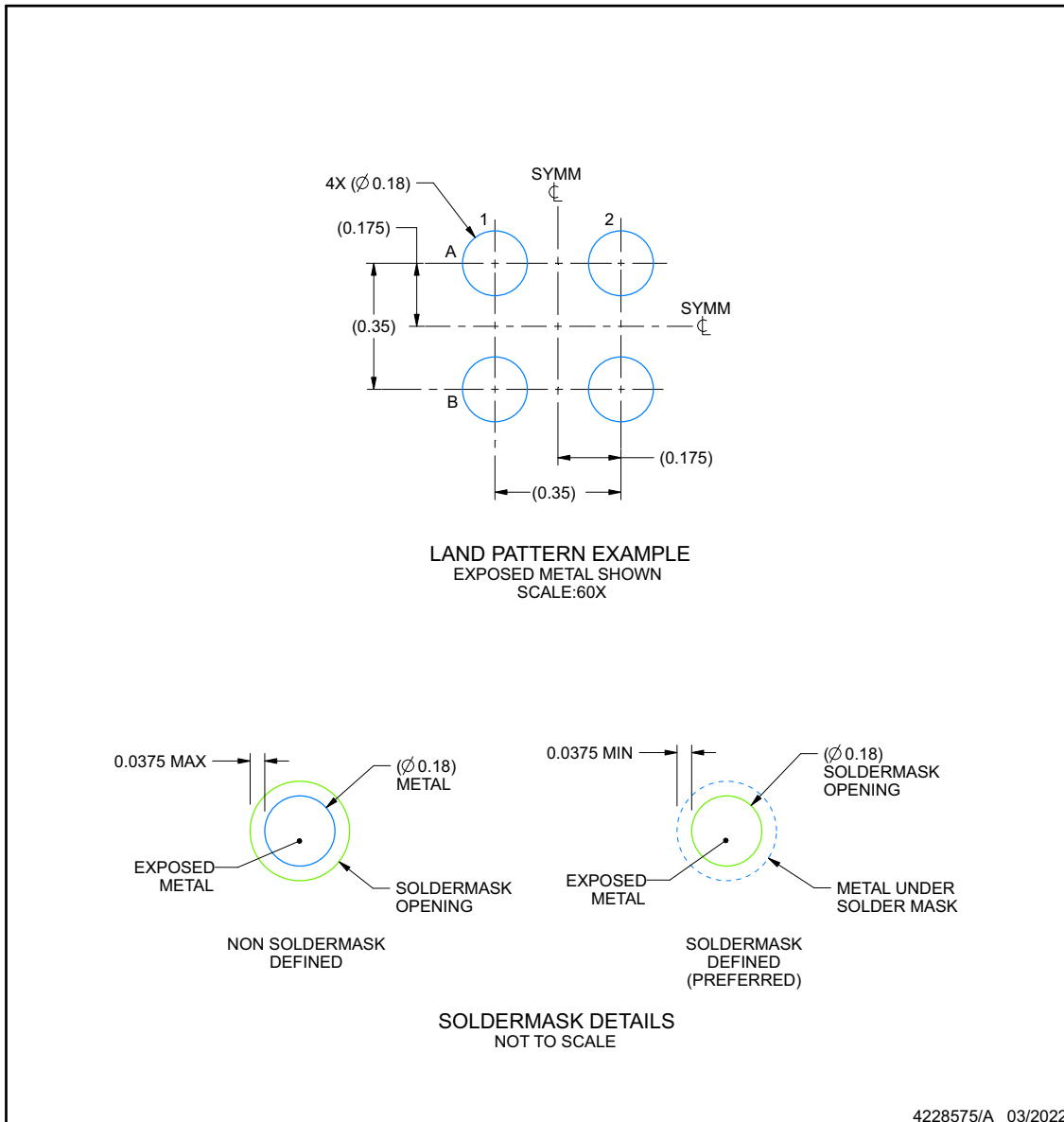

NOTES: (continued)

- Final dimensions may vary due to manufacturing tolerance considerations and also routing constraints. Refer to Texas Instruments Literature No. SNVA009 ([www.ti.com/lit/snva009](http://www.ti.com/lit/snva009)).

## EXAMPLE STENCIL DESIGN

**YCK0004-C01**

**DSBGA - 0.33mm MAX HEIGHT**

DIE SIZE BALL GRID ARRAY

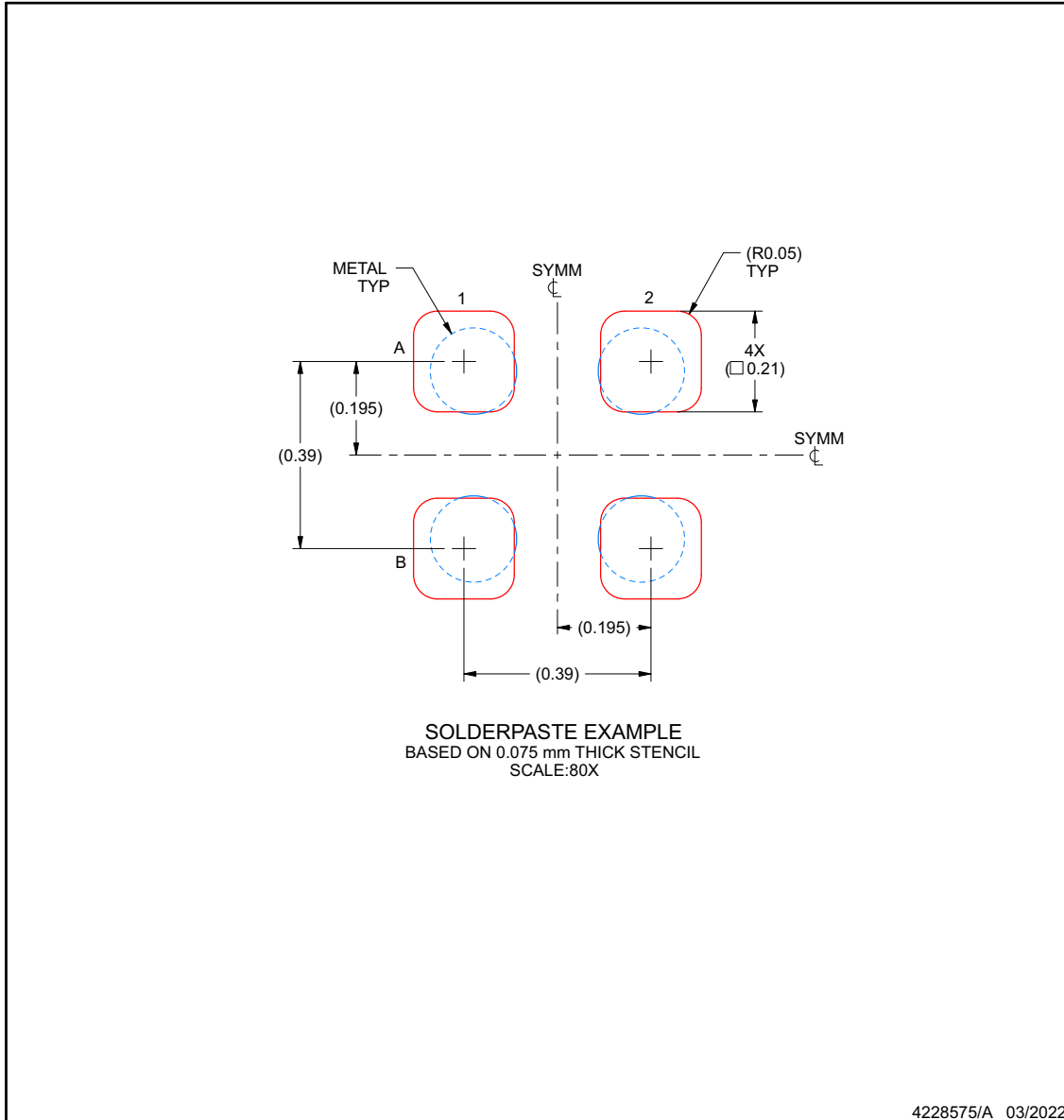

NOTES: (continued)

4. Laser cutting apertures with trapezoidal walls and rounded corners may offer better paste release.

**PACKAGING INFORMATION**

| Orderable Device | Status<br>(1) | Package Type | Package Drawing | Pins | Package Qty | Eco Plan<br>(2) | Lead finish/<br>Ball material<br>(6) | MSL Peak Temp<br>(3) | Op Temp (°C) | Device Marking<br>(4/5) | Samples                 |
|------------------|---------------|--------------|-----------------|------|-------------|-----------------|--------------------------------------|----------------------|--------------|-------------------------|-------------------------|
| PTPS7A2025PDQNR  | ACTIVE        | X2SON        | DQN             | 4    | 3000        | TBD             | Call TI                              | Call TI              | -40 to 125   |                         | <a href="#">Samples</a> |
| PTPS7A2045PDQNR  | ACTIVE        | X2SON        | DQN             | 4    | 3000        | TBD             | Call TI                              | Call TI              | -40 to 125   |                         | <a href="#">Samples</a> |
| TPS7A2009PDBVR   | ACTIVE        | SOT-23       | DBV             | 5    | 3000        | RoHS & Green    | NIPDAU   SN                          | Level-1-260C-UNLIM   | -40 to 125   | 2GBF                    | <a href="#">Samples</a> |
| TPS7A2009PDQNR   | ACTIVE        | X2SON        | DQN             | 4    | 3000        | RoHS & Green    | NIPDAU                               | Level-1-260C-UNLIM   | -40 to 125   | KT                      | <a href="#">Samples</a> |
| TPS7A20105PDQNR  | ACTIVE        | X2SON        | DQN             | 4    | 3000        | RoHS & Green    | NIPDAU                               | Level-1-260C-UNLIM   | -40 to 125   | KS                      | <a href="#">Samples</a> |
| TPS7A2011PYCKR   | ACTIVE        | DSBGA        | YCK             | 4    | 12000       | RoHS & Green    | SNAGCU                               | Level-1-260C-UNLIM   | -40 to 125   | Q                       | <a href="#">Samples</a> |
| TPS7A2012PDBVR   | ACTIVE        | SOT-23       | DBV             | 5    | 3000        | RoHS & Green    | NIPDAU   SN                          | Level-1-260C-UNLIM   | -40 to 125   | 2ATF                    | <a href="#">Samples</a> |
| TPS7A2012PDQNR   | ACTIVE        | X2SON        | DQN             | 4    | 3000        | RoHS & Green    | NIPDAU                               | Level-1-260C-UNLIM   | -40 to 125   | JC                      | <a href="#">Samples</a> |
| TPS7A2012PYCJR   | ACTIVE        | DSBGA        | YCJ             | 4    | 12000       | RoHS & Green    | SNAGCU                               | Level-1-260C-UNLIM   | -40 to 125   | M                       | <a href="#">Samples</a> |
| TPS7A2015PDBVR   | ACTIVE        | SOT-23       | DBV             | 5    | 3000        | RoHS & Green    | NIPDAU   SN                          | Level-1-260C-UNLIM   | -40 to 125   | 2DTF                    | <a href="#">Samples</a> |
| TPS7A2015PDQNR   | ACTIVE        | X2SON        | DQN             | 4    | 3000        | RoHS & Green    | NIPDAU   NIPDAUAG                    | Level-1-260C-UNLIM   | -40 to 125   | JD                      | <a href="#">Samples</a> |
| TPS7A201825PDQNR | ACTIVE        | X2SON        | DQN             | 4    | 3000        | RoHS & Green    | NIPDAU   NIPDAUAG                    | Level-1-260C-UNLIM   | -40 to 125   | IQ                      | <a href="#">Samples</a> |
| TPS7A20185PDBVR  | ACTIVE        | SOT-23       | DBV             | 5    | 3000        | RoHS & Green    | NIPDAU   SN                          | Level-1-260C-UNLIM   | -40 to 125   | 2CBF                    | <a href="#">Samples</a> |
| TPS7A20185PDQNR  | ACTIVE        | X2SON        | DQN             | 4    | 3000        | RoHS & Green    | NIPDAU   NIPDAUAG                    | Level-1-260C-UNLIM   | -40 to 125   | JE                      | <a href="#">Samples</a> |
| TPS7A20185PYCKR  | ACTIVE        | DSBGA        | YCK             | 4    | 12000       | RoHS & Green    | SNAGCU                               | Level-1-260C-UNLIM   | -40 to 125   | T                       | <a href="#">Samples</a> |
| TPS7A2018PDBVR   | ACTIVE        | SOT-23       | DBV             | 5    | 3000        | RoHS & Green    | NIPDAU   SN                          | Level-1-260C-UNLIM   | -40 to 125   | 2AUF                    | <a href="#">Samples</a> |
| TPS7A2018PDQNR   | ACTIVE        | X2SON        | DQN             | 4    | 3000        | RoHS & Green    | NIPDAU   NIPDAUAG                    | Level-1-260C-UNLIM   | -40 to 125   | JF                      | <a href="#">Samples</a> |
| TPS7A2018PYCKR   | ACTIVE        | DSBGA        | YCK             | 4    | 12000       | RoHS & Green    | SNAGCU                               | Level-1-260C-UNLIM   | -40 to 125   | D                       | <a href="#">Samples</a> |
| TPS7A2020PYCKR   | ACTIVE        | DSBGA        | YCK             | 4    | 12000       | RoHS & Green    | SNAGCU                               | Level-1-260C-UNLIM   | -40 to 125   | S                       | <a href="#">Samples</a> |
| TPS7A2022PYCKR   | ACTIVE        | DSBGA        | YCK             | 4    | 12000       | RoHS & Green    | SNAGCU                               | Level-1-260C-UNLIM   | -40 to 125   | K                       | <a href="#">Samples</a> |



| Orderable Device | Status<br>(1) | Package Type | Package Drawing | Pins | Package Qty | Eco Plan<br>(2) | Lead finish/<br>Ball material<br>(6) | MSL Peak Temp<br>(3) | Op Temp (°C) | Device Marking<br>(4/5) | Samples                 |
|------------------|---------------|--------------|-----------------|------|-------------|-----------------|--------------------------------------|----------------------|--------------|-------------------------|-------------------------|
| TPS7A2024PDBVR   | ACTIVE        | SOT-23       | DBV             | 5    | 3000        | RoHS & Green    | NIPDAU   SN                          | Level-1-260C-UNLIM   | -40 to 125   | 2CCF                    | <a href="#">Samples</a> |
| TPS7A2025PDBVR   | ACTIVE        | SOT-23       | DBV             | 5    | 3000        | RoHS & Green    | NIPDAU   SN                          | Level-1-260C-UNLIM   | -40 to 125   | 2AVF                    | <a href="#">Samples</a> |
| TPS7A2025PDQNR   | ACTIVE        | X2SON        | DQN             | 4    | 3000        | RoHS & Green    | NIPDAU                               | Level-1-260C-UNLIM   | -40 to 125   | JG                      | <a href="#">Samples</a> |
| TPS7A2025PYCJR   | ACTIVE        | DSBGA        | YCJ             | 4    | 12000       | RoHS & Green    | SNAGCU                               | Level-1-260C-UNLIM   | -40 to 125   | L                       | <a href="#">Samples</a> |
| TPS7A2027PDQNR   | ACTIVE        | X2SON        | DQN             | 4    | 3000        | RoHS & Green    | NIPDAU                               | Level-1-260C-UNLIM   | -40 to 125   | KO                      | <a href="#">Samples</a> |
| TPS7A2027PYCJR   | ACTIVE        | DSBGA        | YCJ             | 4    | 12000       | RoHS & Green    | SNAGCU                               | Level-1-260C-UNLIM   | -40 to 125   | N                       | <a href="#">Samples</a> |
| TPS7A20285PDBVR  | ACTIVE        | SOT-23       | DBV             | 5    | 3000        | RoHS & Green    | NIPDAU   SN                          | Level-1-260C-UNLIM   | -40 to 125   | 2GCF                    | <a href="#">Samples</a> |
| TPS7A20285PDQNR  | ACTIVE        | X2SON        | DQN             | 4    | 3000        | RoHS & Green    | NIPDAU                               | Level-1-260C-UNLIM   | -40 to 125   | KN                      | <a href="#">Samples</a> |
| TPS7A20285PYCKR  | ACTIVE        | DSBGA        | YCK             | 4    | 12000       | RoHS & Green    | SNAGCU                               | Level-1-260C-UNLIM   | -40 to 125   | P                       | <a href="#">Samples</a> |
| TPS7A2028PDBVR   | ACTIVE        | SOT-23       | DBV             | 5    | 3000        | RoHS & Green    | NIPDAU   SN                          | Level-1-260C-UNLIM   | -40 to 125   | 2AWF                    | <a href="#">Samples</a> |
| TPS7A2028PDQNR   | ACTIVE        | X2SON        | DQN             | 4    | 3000        | RoHS & Green    | NIPDAU   NIPDAUAG                    | Level-1-260C-UNLIM   | -40 to 125   | JH                      | <a href="#">Samples</a> |
| TPS7A2028PDQNRM3 | ACTIVE        | X2SON        | DQN             | 4    | 3000        | RoHS & Green    | NIPDAU                               | Level-1-260C-UNLIM   | -40 to 125   | JH                      | <a href="#">Samples</a> |
| TPS7A2028PYCJR   | ACTIVE        | DSBGA        | YCJ             | 4    | 12000       | RoHS & Green    | SNAGCU                               | Level-1-260C-UNLIM   | -40 to 125   | E                       | <a href="#">Samples</a> |
| TPS7A2028PYCKR   | ACTIVE        | DSBGA        | YCK             | 4    | 12000       | RoHS & Green    | SNAGCU                               | Level-1-260C-UNLIM   | -40 to 125   | E                       | <a href="#">Samples</a> |
| TPS7A2029PDQNR   | ACTIVE        | X2SON        | DQN             | 4    | 3000        | RoHS & Green    | NIPDAU                               | Level-1-260C-UNLIM   | -40 to 125   | JI                      | <a href="#">Samples</a> |
| TPS7A2030PDBVR   | ACTIVE        | SOT-23       | DBV             | 5    | 3000        | RoHS & Green    | NIPDAU   SN                          | Level-1-260C-UNLIM   | -40 to 125   | 2AXF                    | <a href="#">Samples</a> |
| TPS7A2030PDQNR   | ACTIVE        | X2SON        | DQN             | 4    | 3000        | RoHS & Green    | NIPDAU                               | Level-1-260C-UNLIM   | -40 to 125   | JJ                      | <a href="#">Samples</a> |
| TPS7A2031PDBVR   | ACTIVE        | SOT-23       | DBV             | 5    | 3000        | RoHS & Green    | NIPDAU   SN                          | Level-1-260C-UNLIM   | -40 to 125   | 2GDF                    | <a href="#">Samples</a> |
| TPS7A2032PDBVR   | ACTIVE        | SOT-23       | DBV             | 5    | 3000        | RoHS & Green    | NIPDAU   SN                          | Level-1-260C-UNLIM   | -40 to 125   | 2GEF                    | <a href="#">Samples</a> |
| TPS7A2033PDBVR   | ACTIVE        | SOT-23       | DBV             | 5    | 3000        | RoHS & Green    | NIPDAU   SN                          | Level-1-260C-UNLIM   | -40 to 125   | 2AZF                    | <a href="#">Samples</a> |
| TPS7A2033PDQNR   | ACTIVE        | X2SON        | DQN             | 4    | 3000        | RoHS & Green    | NIPDAU   NIPDAUAG                    | Level-1-260C-UNLIM   | -40 to 125   | JA                      | <a href="#">Samples</a> |

| Orderable Device | Status<br>(1) | Package Type | Package Drawing | Pins | Package Qty | Eco Plan<br>(2) | Lead finish/<br>Ball material<br>(6) | MSL Peak Temp<br>(3) | Op Temp (°C) | Device Marking<br>(4/5) | Samples                 |
|------------------|---------------|--------------|-----------------|------|-------------|-----------------|--------------------------------------|----------------------|--------------|-------------------------|-------------------------|
| TPS7A2033PYCJR   | ACTIVE        | DSBGA        | YCJ             | 4    | 12000       | RoHS & Green    | SNAGCU                               | Level-1-260C-UNLIM   | -40 to 125   | O                       | <a href="#">Samples</a> |
| TPS7A2036PDBVR   | ACTIVE        | SOT-23       | DBV             | 5    | 3000        | RoHS & Green    | NIPDAU   SN                          | Level-1-260C-UNLIM   | -40 to 125   | 2GIF                    | <a href="#">Samples</a> |
| TPS7A2036PDQNR   | ACTIVE        | X2SON        | DQN             | 4    | 3000        | RoHS & Green    | NIPDAU                               | Level-1-260C-UNLIM   | -40 to 125   | KP                      | <a href="#">Samples</a> |
| TPS7A2040PDQNR   | ACTIVE        | X2SON        | DQN             | 4    | 3000        | RoHS & Green    | NIPDAU                               | Level-1-260C-UNLIM   | -40 to 125   | KQ                      | <a href="#">Samples</a> |
| TPS7A2042PDBVR   | ACTIVE        | SOT-23       | DBV             | 5    | 3000        | RoHS & Green    | NIPDAU   SN                          | Level-1-260C-UNLIM   | -40 to 125   | 2GFF                    | <a href="#">Samples</a> |
| TPS7A2042PDQNR   | ACTIVE        | X2SON        | DQN             | 4    | 3000        | RoHS & Green    | NIPDAU                               | Level-1-260C-UNLIM   | -40 to 125   | KV                      | <a href="#">Samples</a> |
| TPS7A2045PDBVR   | ACTIVE        | SOT-23       | DBV             | 5    | 3000        | RoHS & Green    | NIPDAU   SN                          | Level-1-260C-UNLIM   | -40 to 125   | 2GGF                    | <a href="#">Samples</a> |
| TPS7A2045PDQNR   | ACTIVE        | X2SON        | DQN             | 4    | 3000        | RoHS & Green    | NIPDAU                               | Level-1-260C-UNLIM   | -40 to 125   | JB                      | <a href="#">Samples</a> |
| TPS7A2050PDBVR   | ACTIVE        | SOT-23       | DBV             | 5    | 3000        | RoHS & Green    | NIPDAU   SN                          | Level-1-260C-UNLIM   | -40 to 125   | 2B1F                    | <a href="#">Samples</a> |
| TPS7A2050PDQNR   | ACTIVE        | X2SON        | DQN             | 4    | 3000        | RoHS & Green    | NIPDAU                               | Level-1-260C-UNLIM   | -40 to 125   | KR                      | <a href="#">Samples</a> |
| TPS7A2050PYCKR   | ACTIVE        | DSBGA        | YCK             | 4    | 12000       | RoHS & Green    | SNAGCU                               | Level-1-260C-UNLIM   | -40 to 125   | H                       | <a href="#">Samples</a> |
| TPS7A2055PDBVR   | ACTIVE        | SOT-23       | DBV             | 5    | 3000        | RoHS & Green    | NIPDAU   SN                          | Level-1-260C-UNLIM   | -40 to 125   | 2GHF                    | <a href="#">Samples</a> |

(1) The marketing status values are defined as follows:

**ACTIVE:** Product device recommended for new designs.

**LIFEBUY:** TI has announced that the device will be discontinued, and a lifetime-buy period is in effect.

**NRND:** Not recommended for new designs. Device is in production to support existing customers, but TI does not recommend using this part in a new design.

**PREVIEW:** Device has been announced but is not in production. Samples may or may not be available.

**OBSOLETE:** TI has discontinued the production of the device.

(2) **RoHS:** TI defines "RoHS" to mean semiconductor products that are compliant with the current EU RoHS requirements for all 10 RoHS substances, including the requirement that RoHS substance do not exceed 0.1% by weight in homogeneous materials. Where designed to be soldered at high temperatures, "RoHS" products are suitable for use in specified lead-free processes. TI may reference these types of products as "Pb-Free".

**RoHS Exempt:** TI defines "RoHS Exempt" to mean products that contain lead but are compliant with EU RoHS pursuant to a specific EU RoHS exemption.

**Green:** TI defines "Green" to mean the content of Chlorine (Cl) and Bromine (Br) based flame retardants meet JS709B low halogen requirements of <=1000ppm threshold. Antimony trioxide based flame retardants must also meet the <=1000ppm threshold requirement.

(3) MSL, Peak Temp. - The Moisture Sensitivity Level rating according to the JEDEC industry standard classifications, and peak solder temperature.

- (4) There may be additional marking, which relates to the logo, the lot trace code information, or the environmental category on the device.
- (5) Multiple Device Markings will be inside parentheses. Only one Device Marking contained in parentheses and separated by a "~" will appear on a device. If a line is indented then it is a continuation of the previous line and the two combined represent the entire Device Marking for that device.
- (6) Lead finish/Ball material - Orderable Devices may have multiple material finish options. Finish options are separated by a vertical ruled line. Lead finish/Ball material values may wrap to two lines if the finish value exceeds the maximum column width.

**Important Information and Disclaimer:**The information provided on this page represents TI's knowledge and belief as of the date that it is provided. TI bases its knowledge and belief on information provided by third parties, and makes no representation or warranty as to the accuracy of such information. Efforts are underway to better integrate information from third parties. TI has taken and continues to take reasonable steps to provide representative and accurate information but may not have conducted destructive testing or chemical analysis on incoming materials and chemicals. TI and TI suppliers consider certain information to be proprietary, and thus CAS numbers and other limited information may not be available for release.

In no event shall TI's liability arising out of such information exceed the total purchase price of the TI part(s) at issue in this document sold by TI to Customer on an annual basis.

## TAPE AND REEL INFORMATION



### QUADRANT ASSIGNMENTS FOR PIN 1 ORIENTATION IN TAPE

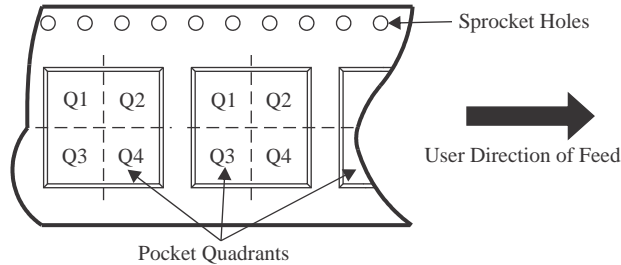

\*All dimensions are nominal

| Device           | Package Type | Package Drawing | Pins | SPQ   | Reel Diameter (mm) | Reel Width W1 (mm) | A0 (mm) | B0 (mm) | K0 (mm) | P1 (mm) | W (mm) | Pin1 Quadrant |
|------------------|--------------|-----------------|------|-------|--------------------|--------------------|---------|---------|---------|---------|--------|---------------|
| TPS7A2009PDBVR   | SOT-23       | DBV             | 5    | 3000  | 178.0              | 9.0                | 3.3     | 3.2     | 1.4     | 4.0     | 8.0    | Q3            |
| TPS7A2009PDBVR   | SOT-23       | DBV             | 5    | 3000  | 180.0              | 8.4                | 3.2     | 3.2     | 1.4     | 4.0     | 8.0    | Q3            |
| TPS7A2009PDQNR   | X2SON        | DQN             | 4    | 3000  | 180.0              | 9.5                | 1.16    | 1.16    | 0.5     | 4.0     | 8.0    | Q2            |
| TPS7A20105PDQNR  | X2SON        | DQN             | 4    | 3000  | 180.0              | 9.5                | 1.16    | 1.16    | 0.5     | 4.0     | 8.0    | Q2            |
| TPS7A2011PYCKR   | DSBGA        | YCK             | 4    | 12000 | 180.0              | 8.4                | 0.71    | 0.71    | 0.42    | 2.0     | 8.0    | Q1            |
| TPS7A2012PDBVR   | SOT-23       | DBV             | 5    | 3000  | 180.0              | 8.4                | 3.2     | 3.2     | 1.4     | 4.0     | 8.0    | Q3            |
| TPS7A2012PDBVR   | SOT-23       | DBV             | 5    | 3000  | 180.0              | 8.4                | 3.2     | 3.2     | 1.4     | 4.0     | 8.0    | Q3            |
| TPS7A2012PDQNR   | X2SON        | DQN             | 4    | 3000  | 180.0              | 9.5                | 1.16    | 1.16    | 0.5     | 4.0     | 8.0    | Q2            |
| TPS7A2012PYCJR   | DSBGA        | YCJ             | 4    | 12000 | 180.0              | 8.4                | 0.71    | 0.71    | 0.42    | 2.0     | 8.0    | Q1            |
| TPS7A2015PDBVR   | SOT-23       | DBV             | 5    | 3000  | 178.0              | 9.0                | 3.3     | 3.2     | 1.4     | 4.0     | 8.0    | Q3            |
| TPS7A2015PDBVR   | SOT-23       | DBV             | 5    | 3000  | 180.0              | 8.4                | 3.2     | 3.2     | 1.4     | 4.0     | 8.0    | Q3            |
| TPS7A2015PDQNR   | X2SON        | DQN             | 4    | 3000  | 180.0              | 9.5                | 1.16    | 1.16    | 0.5     | 4.0     | 8.0    | Q2            |
| TPS7A2015PDQNR   | X2SON        | DQN             | 4    | 3000  | 178.0              | 8.4                | 1.13    | 1.13    | 0.53    | 4.0     | 8.0    | Q2            |
| TPS7A201825PDQNR | X2SON        | DQN             | 4    | 3000  | 180.0              | 9.5                | 1.16    | 1.16    | 0.5     | 4.0     | 8.0    | Q2            |
| TPS7A201825PDQNR | X2SON        | DQN             | 4    | 3000  | 178.0              | 8.4                | 1.13    | 1.13    | 0.53    | 4.0     | 8.0    | Q2            |
| TPS7A20185PDBVR  | SOT-23       | DBV             | 5    | 3000  | 180.0              | 8.4                | 3.2     | 3.2     | 1.4     | 4.0     | 8.0    | Q3            |

| Device           | Package Type | Package Drawing | Pins | SPQ   | Reel Diameter (mm) | Reel Width W1 (mm) | A0 (mm) | B0 (mm) | K0 (mm) | P1 (mm) | W (mm) | Pin1 Quadrant |
|------------------|--------------|-----------------|------|-------|--------------------|--------------------|---------|---------|---------|---------|--------|---------------|
| TPS7A20185PDBVR  | SOT-23       | DBV             | 5    | 3000  | 180.0              | 8.4                | 3.2     | 3.2     | 1.4     | 4.0     | 8.0    | Q3            |
| TPS7A20185PDQNR  | X2SON        | DQN             | 4    | 3000  | 178.0              | 8.4                | 1.13    | 1.13    | 0.53    | 4.0     | 8.0    | Q2            |
| TPS7A20185PDQNR  | X2SON        | DQN             | 4    | 3000  | 180.0              | 9.5                | 1.16    | 1.16    | 0.5     | 4.0     | 8.0    | Q2            |
| TPS7A20185PYCKR  | DSBGA        | YCK             | 4    | 12000 | 180.0              | 8.4                | 0.71    | 0.71    | 0.42    | 2.0     | 8.0    | Q1            |
| TPS7A2018PDBVR   | SOT-23       | DBV             | 5    | 3000  | 180.0              | 8.4                | 3.2     | 3.2     | 1.4     | 4.0     | 8.0    | Q3            |
| TPS7A2018PDBVR   | SOT-23       | DBV             | 5    | 3000  | 180.0              | 8.4                | 3.2     | 3.2     | 1.4     | 4.0     | 8.0    | Q3            |
| TPS7A2018PDQNR   | X2SON        | DQN             | 4    | 3000  | 178.0              | 8.4                | 1.13    | 1.13    | 0.53    | 4.0     | 8.0    | Q2            |
| TPS7A2018PDQNR   | X2SON        | DQN             | 4    | 3000  | 180.0              | 9.5                | 1.16    | 1.16    | 0.5     | 4.0     | 8.0    | Q2            |
| TPS7A2018PYCKR   | DSBGA        | YCK             | 4    | 12000 | 180.0              | 8.4                | 0.71    | 0.71    | 0.42    | 2.0     | 8.0    | Q1            |
| TPS7A2018PYCKR   | DSBGA        | YCK             | 4    | 12000 | 180.0              | 8.4                | 0.71    | 0.71    | 0.42    | 2.0     | 8.0    | Q1            |
| TPS7A2020PYCKR   | DSBGA        | YCK             | 4    | 12000 | 180.0              | 8.4                | 0.71    | 0.71    | 0.42    | 2.0     | 8.0    | Q1            |
| TPS7A2022PYCKR   | DSBGA        | YCK             | 4    | 12000 | 180.0              | 8.4                | 0.71    | 0.71    | 0.42    | 2.0     | 8.0    | Q1            |
| TPS7A2022PYCKR   | DSBGA        | YCK             | 4    | 12000 | 180.0              | 8.4                | 0.71    | 0.71    | 0.42    | 2.0     | 8.0    | Q1            |
| TPS7A2024PDBVR   | SOT-23       | DBV             | 5    | 3000  | 180.0              | 8.4                | 3.2     | 3.2     | 1.4     | 4.0     | 8.0    | Q3            |
| TPS7A2024PDBVR   | SOT-23       | DBV             | 5    | 3000  | 180.0              | 8.4                | 3.2     | 3.2     | 1.4     | 4.0     | 8.0    | Q3            |
| TPS7A2025PDBVR   | SOT-23       | DBV             | 5    | 3000  | 180.0              | 8.4                | 3.2     | 3.2     | 1.4     | 4.0     | 8.0    | Q3            |
| TPS7A2025PDBVR   | SOT-23       | DBV             | 5    | 3000  | 180.0              | 8.4                | 3.2     | 3.2     | 1.4     | 4.0     | 8.0    | Q3            |
| TPS7A2025PDQNR   | X2SON        | DQN             | 4    | 3000  | 180.0              | 9.5                | 1.16    | 1.16    | 0.5     | 4.0     | 8.0    | Q2            |
| TPS7A2025PYCJR   | DSBGA        | YCJ             | 4    | 12000 | 180.0              | 8.4                | 0.71    | 0.71    | 0.42    | 2.0     | 8.0    | Q1            |
| TPS7A2027PDQNR   | X2SON        | DQN             | 4    | 3000  | 180.0              | 9.5                | 1.16    | 1.16    | 0.5     | 4.0     | 8.0    | Q2            |
| TPS7A2027PYCJR   | DSBGA        | YCJ             | 4    | 12000 | 180.0              | 8.4                | 0.71    | 0.71    | 0.42    | 2.0     | 8.0    | Q1            |
| TPS7A2027PYCJR   | DSBGA        | YCJ             | 4    | 12000 | 180.0              | 8.4                | 0.71    | 0.71    | 0.42    | 2.0     | 8.0    | Q1            |
| TPS7A20285PDBVR  | SOT-23       | DBV             | 5    | 3000  | 180.0              | 8.4                | 3.2     | 3.2     | 1.4     | 4.0     | 8.0    | Q3            |
| TPS7A20285PDBVR  | SOT-23       | DBV             | 5    | 3000  | 178.0              | 9.0                | 3.3     | 3.2     | 1.4     | 4.0     | 8.0    | Q3            |
| TPS7A20285PDQNR  | X2SON        | DQN             | 4    | 3000  | 180.0              | 9.5                | 1.16    | 1.16    | 0.5     | 4.0     | 8.0    | Q2            |
| TPS7A20285PYCKR  | DSBGA        | YCK             | 4    | 12000 | 180.0              | 8.4                | 0.71    | 0.71    | 0.42    | 2.0     | 8.0    | Q1            |
| TPS7A2028PDBVR   | SOT-23       | DBV             | 5    | 3000  | 180.0              | 8.4                | 3.2     | 3.2     | 1.4     | 4.0     | 8.0    | Q3            |
| TPS7A2028PDBVR   | SOT-23       | DBV             | 5    | 3000  | 180.0              | 8.4                | 3.2     | 3.2     | 1.4     | 4.0     | 8.0    | Q3            |
| TPS7A2028PDQNR   | X2SON        | DQN             | 4    | 3000  | 178.0              | 8.4                | 1.13    | 1.13    | 0.53    | 4.0     | 8.0    | Q2            |
| TPS7A2028PDQNR   | X2SON        | DQN             | 4    | 3000  | 180.0              | 9.5                | 1.16    | 1.16    | 0.5     | 4.0     | 8.0    | Q2            |
| TPS7A2028PDQNRM3 | X2SON        | DQN             | 4    | 3000  | 180.0              | 8.4                | 1.16    | 1.16    | 0.5     | 4.0     | 8.0    | Q2            |
| TPS7A2028PYCJR   | DSBGA        | YCJ             | 4    | 12000 | 180.0              | 8.4                | 0.71    | 0.71    | 0.42    | 2.0     | 8.0    | Q1            |
| TPS7A2028PYCKR   | DSBGA        | YCK             | 4    | 12000 | 180.0              | 8.4                | 0.71    | 0.71    | 0.42    | 2.0     | 8.0    | Q1            |
| TPS7A2029PDQNR   | X2SON        | DQN             | 4    | 3000  | 180.0              | 9.5                | 1.16    | 1.16    | 0.5     | 4.0     | 8.0    | Q2            |
| TPS7A2030PDBVR   | SOT-23       | DBV             | 5    | 3000  | 180.0              | 8.4                | 3.2     | 3.2     | 1.4     | 4.0     | 8.0    | Q3            |
| TPS7A2030PDBVR   | SOT-23       | DBV             | 5    | 3000  | 180.0              | 8.4                | 3.2     | 3.2     | 1.4     | 4.0     | 8.0    | Q3            |
| TPS7A2030PDQNR   | X2SON        | DQN             | 4    | 3000  | 180.0              | 9.5                | 1.16    | 1.16    | 0.5     | 4.0     | 8.0    | Q2            |
| TPS7A2031PDBVR   | SOT-23       | DBV             | 5    | 3000  | 180.0              | 8.4                | 3.2     | 3.2     | 1.4     | 4.0     | 8.0    | Q3            |
| TPS7A2031PDBVR   | SOT-23       | DBV             | 5    | 3000  | 178.0              | 9.0                | 3.3     | 3.2     | 1.4     | 4.0     | 8.0    | Q3            |
| TPS7A2032PDBVR   | SOT-23       | DBV             | 5    | 3000  | 178.0              | 9.0                | 3.3     | 3.2     | 1.4     | 4.0     | 8.0    | Q3            |
| TPS7A2032PDBVR   | SOT-23       | DBV             | 5    | 3000  | 180.0              | 8.4                | 3.2     | 3.2     | 1.4     | 4.0     | 8.0    | Q3            |

| Device         | Package Type | Package Drawing | Pins | SPQ   | Reel Diameter (mm) | Reel Width W1 (mm) | A0 (mm) | B0 (mm) | K0 (mm) | P1 (mm) | W (mm) | Pin1 Quadrant |
|----------------|--------------|-----------------|------|-------|--------------------|--------------------|---------|---------|---------|---------|--------|---------------|
| TPS7A2033PDBVR | SOT-23       | DBV             | 5    | 3000  | 180.0              | 8.4                | 3.2     | 3.2     | 1.4     | 4.0     | 8.0    | Q3            |
| TPS7A2033PDBVR | SOT-23       | DBV             | 5    | 3000  | 180.0              | 8.4                | 3.2     | 3.2     | 1.4     | 4.0     | 8.0    | Q3            |
| TPS7A2033PDQNR | X2SON        | DQN             | 4    | 3000  | 178.0              | 8.4                | 1.13    | 1.13    | 0.53    | 4.0     | 8.0    | Q2            |
| TPS7A2033PDQNR | X2SON        | DQN             | 4    | 3000  | 180.0              | 9.5                | 1.16    | 1.16    | 0.5     | 4.0     | 8.0    | Q2            |
| TPS7A2033PYCJR | DSBGA        | YCJ             | 4    | 12000 | 180.0              | 8.4                | 0.71    | 0.71    | 0.42    | 2.0     | 8.0    | Q1            |
| TPS7A2033PYCJR | DSBGA        | YCJ             | 4    | 12000 | 180.0              | 8.4                | 0.71    | 0.71    | 0.42    | 2.0     | 8.0    | Q1            |
| TPS7A2036PDBVR | SOT-23       | DBV             | 5    | 3000  | 178.0              | 9.0                | 3.3     | 3.2     | 1.4     | 4.0     | 8.0    | Q3            |
| TPS7A2036PDBVR | SOT-23       | DBV             | 5    | 3000  | 180.0              | 8.4                | 3.2     | 3.2     | 1.4     | 4.0     | 8.0    | Q3            |
| TPS7A2036PDQNR | X2SON        | DQN             | 4    | 3000  | 180.0              | 9.5                | 1.16    | 1.16    | 0.5     | 4.0     | 8.0    | Q2            |
| TPS7A2040PDQNR | X2SON        | DQN             | 4    | 3000  | 180.0              | 9.5                | 1.16    | 1.16    | 0.5     | 4.0     | 8.0    | Q2            |
| TPS7A2042PDBVR | SOT-23       | DBV             | 5    | 3000  | 178.0              | 9.0                | 3.3     | 3.2     | 1.4     | 4.0     | 8.0    | Q3            |
| TPS7A2042PDBVR | SOT-23       | DBV             | 5    | 3000  | 180.0              | 8.4                | 3.2     | 3.2     | 1.4     | 4.0     | 8.0    | Q3            |
| TPS7A2042PDQNR | X2SON        | DQN             | 4    | 3000  | 180.0              | 9.5                | 1.16    | 1.16    | 0.5     | 4.0     | 8.0    | Q2            |
| TPS7A2045PDBVR | SOT-23       | DBV             | 5    | 3000  | 180.0              | 8.4                | 3.2     | 3.2     | 1.4     | 4.0     | 8.0    | Q3            |
| TPS7A2045PDBVR | SOT-23       | DBV             | 5    | 3000  | 178.0              | 9.0                | 3.3     | 3.2     | 1.4     | 4.0     | 8.0    | Q3            |
| TPS7A2045PDQNR | X2SON        | DQN             | 4    | 3000  | 180.0              | 9.5                | 1.16    | 1.16    | 0.5     | 4.0     | 8.0    | Q2            |
| TPS7A2050PDBVR | SOT-23       | DBV             | 5    | 3000  | 180.0              | 8.4                | 3.2     | 3.2     | 1.4     | 4.0     | 8.0    | Q3            |
| TPS7A2050PDBVR | SOT-23       | DBV             | 5    | 3000  | 180.0              | 8.4                | 3.2     | 3.2     | 1.4     | 4.0     | 8.0    | Q3            |
| TPS7A2050PDQNR | X2SON        | DQN             | 4    | 3000  | 180.0              | 9.5                | 1.16    | 1.16    | 0.5     | 4.0     | 8.0    | Q2            |
| TPS7A2050PYCKR | DSBGA        | YCK             | 4    | 12000 | 180.0              | 8.4                | 0.71    | 0.71    | 0.42    | 2.0     | 8.0    | Q1            |
| TPS7A2050PYCKR | DSBGA        | YCK             | 4    | 12000 | 180.0              | 8.4                | 0.71    | 0.71    | 0.42    | 2.0     | 8.0    | Q1            |
| TPS7A2055PDBVR | SOT-23       | DBV             | 5    | 3000  | 178.0              | 9.0                | 3.3     | 3.2     | 1.4     | 4.0     | 8.0    | Q3            |
| TPS7A2055PDBVR | SOT-23       | DBV             | 5    | 3000  | 180.0              | 8.4                | 3.2     | 3.2     | 1.4     | 4.0     | 8.0    | Q3            |

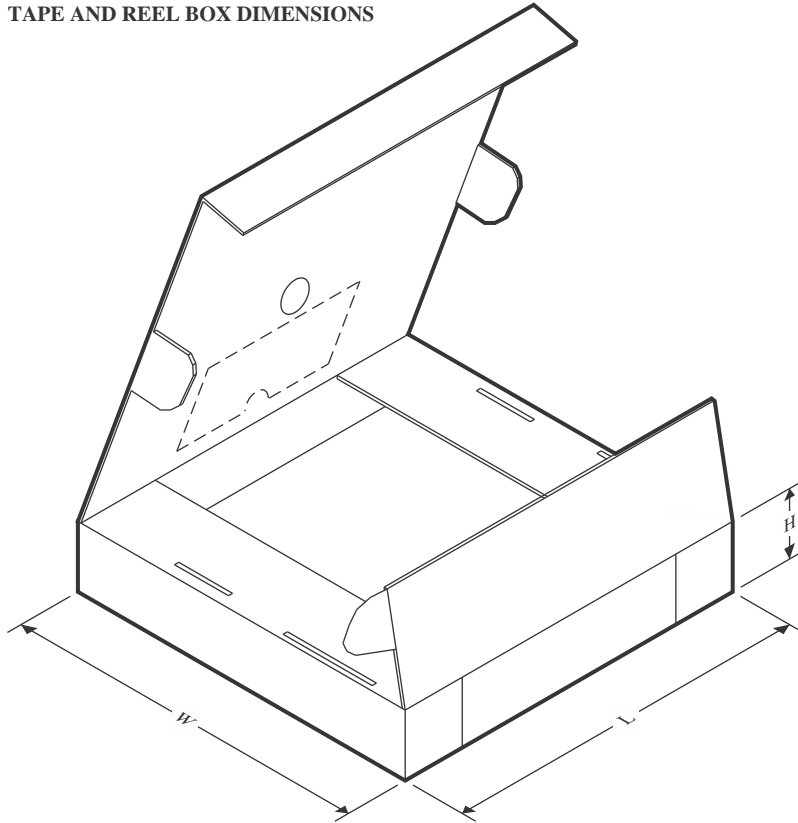
**TAPE AND REEL BOX DIMENSIONS**

\*All dimensions are nominal

| Device           | Package Type | Package Drawing | Pins | SPQ   | Length (mm) | Width (mm) | Height (mm) |
|------------------|--------------|-----------------|------|-------|-------------|------------|-------------|
| TPS7A2009PDBVR   | SOT-23       | DBV             | 5    | 3000  | 180.0       | 180.0      | 18.0        |
| TPS7A2009PDBVR   | SOT-23       | DBV             | 5    | 3000  | 210.0       | 185.0      | 35.0        |
| TPS7A2009PDQNR   | X2SON        | DQN             | 4    | 3000  | 184.0       | 184.0      | 19.0        |
| TPS7A20105PDQNR  | X2SON        | DQN             | 4    | 3000  | 184.0       | 184.0      | 19.0        |
| TPS7A2011PYCKR   | DSBGA        | YCK             | 4    | 12000 | 182.0       | 182.0      | 20.0        |
| TPS7A2012PDBVR   | SOT-23       | DBV             | 5    | 3000  | 210.0       | 185.0      | 35.0        |
| TPS7A2012PDBVR   | SOT-23       | DBV             | 5    | 3000  | 210.0       | 185.0      | 35.0        |
| TPS7A2012PDQNR   | X2SON        | DQN             | 4    | 3000  | 184.0       | 184.0      | 19.0        |
| TPS7A2012PYCJR   | DSBGA        | YCJ             | 4    | 12000 | 182.0       | 182.0      | 20.0        |
| TPS7A2015PDBVR   | SOT-23       | DBV             | 5    | 3000  | 180.0       | 180.0      | 18.0        |
| TPS7A2015PDBVR   | SOT-23       | DBV             | 5    | 3000  | 210.0       | 185.0      | 35.0        |
| TPS7A2015PDQNR   | X2SON        | DQN             | 4    | 3000  | 184.0       | 184.0      | 19.0        |
| TPS7A2015PDQNR   | X2SON        | DQN             | 4    | 3000  | 205.0       | 200.0      | 33.0        |
| TPS7A201825PDQNR | X2SON        | DQN             | 4    | 3000  | 184.0       | 184.0      | 19.0        |
| TPS7A201825PDQNR | X2SON        | DQN             | 4    | 3000  | 205.0       | 200.0      | 33.0        |
| TPS7A20185PDBVR  | SOT-23       | DBV             | 5    | 3000  | 210.0       | 185.0      | 35.0        |
| TPS7A20185PDBVR  | SOT-23       | DBV             | 5    | 3000  | 210.0       | 185.0      | 35.0        |
| TPS7A20185PDQNR  | X2SON        | DQN             | 4    | 3000  | 205.0       | 200.0      | 33.0        |

| Device           | Package Type | Package Drawing | Pins | SPQ   | Length (mm) | Width (mm) | Height (mm) |
|------------------|--------------|-----------------|------|-------|-------------|------------|-------------|
| TPS7A20185PDQNR  | X2SON        | DQN             | 4    | 3000  | 184.0       | 184.0      | 19.0        |
| TPS7A20185PYCKR  | DSBGA        | YCK             | 4    | 12000 | 182.0       | 182.0      | 20.0        |
| TPS7A2018PDBVR   | SOT-23       | DBV             | 5    | 3000  | 210.0       | 185.0      | 35.0        |
| TPS7A2018PDBVR   | SOT-23       | DBV             | 5    | 3000  | 210.0       | 185.0      | 35.0        |
| TPS7A2018PDQNR   | X2SON        | DQN             | 4    | 3000  | 205.0       | 200.0      | 33.0        |
| TPS7A2018PDQNR   | X2SON        | DQN             | 4    | 3000  | 184.0       | 184.0      | 19.0        |
| TPS7A2018PYCKR   | DSBGA        | YCK             | 4    | 12000 | 210.0       | 185.0      | 35.0        |
| TPS7A2018PYCKR   | DSBGA        | YCK             | 4    | 12000 | 182.0       | 182.0      | 20.0        |
| TPS7A2020PYCKR   | DSBGA        | YCK             | 4    | 12000 | 182.0       | 182.0      | 20.0        |
| TPS7A2022PYCKR   | DSBGA        | YCK             | 4    | 12000 | 182.0       | 182.0      | 20.0        |
| TPS7A2022PYCKR   | DSBGA        | YCK             | 4    | 12000 | 210.0       | 185.0      | 35.0        |
| TPS7A2024PDBVR   | SOT-23       | DBV             | 5    | 3000  | 210.0       | 185.0      | 35.0        |
| TPS7A2024PDBVR   | SOT-23       | DBV             | 5    | 3000  | 210.0       | 185.0      | 35.0        |
| TPS7A2025PDBVR   | SOT-23       | DBV             | 5    | 3000  | 210.0       | 185.0      | 35.0        |
| TPS7A2025PDBVR   | SOT-23       | DBV             | 5    | 3000  | 210.0       | 185.0      | 35.0        |
| TPS7A2025PDQNR   | X2SON        | DQN             | 4    | 3000  | 184.0       | 184.0      | 19.0        |
| TPS7A2025PYCJR   | DSBGA        | YCJ             | 4    | 12000 | 182.0       | 182.0      | 20.0        |
| TPS7A2027PDQNR   | X2SON        | DQN             | 4    | 3000  | 184.0       | 184.0      | 19.0        |
| TPS7A2027PYCJR   | DSBGA        | YCJ             | 4    | 12000 | 182.0       | 182.0      | 20.0        |
| TPS7A2027PYCJR   | DSBGA        | YCJ             | 4    | 12000 | 210.0       | 185.0      | 35.0        |
| TPS7A20285PDBVR  | SOT-23       | DBV             | 5    | 3000  | 210.0       | 185.0      | 35.0        |
| TPS7A20285PDBVR  | SOT-23       | DBV             | 5    | 3000  | 180.0       | 180.0      | 18.0        |
| TPS7A20285PDQNR  | X2SON        | DQN             | 4    | 3000  | 184.0       | 184.0      | 19.0        |
| TPS7A20285PYCKR  | DSBGA        | YCK             | 4    | 12000 | 182.0       | 182.0      | 20.0        |
| TPS7A2028PDBVR   | SOT-23       | DBV             | 5    | 3000  | 210.0       | 185.0      | 35.0        |
| TPS7A2028PDBVR   | SOT-23       | DBV             | 5    | 3000  | 210.0       | 185.0      | 35.0        |
| TPS7A2028PDQNR   | X2SON        | DQN             | 4    | 3000  | 205.0       | 200.0      | 33.0        |
| TPS7A2028PDQNR   | X2SON        | DQN             | 4    | 3000  | 184.0       | 184.0      | 19.0        |
| TPS7A2028PDQNRM3 | X2SON        | DQN             | 4    | 3000  | 210.0       | 185.0      | 35.0        |
| TPS7A2028PYCJR   | DSBGA        | YCJ             | 4    | 12000 | 182.0       | 182.0      | 20.0        |
| TPS7A2028PYCKR   | DSBGA        | YCK             | 4    | 12000 | 182.0       | 182.0      | 20.0        |
| TPS7A2029PDQNR   | X2SON        | DQN             | 4    | 3000  | 184.0       | 184.0      | 19.0        |
| TPS7A2030PDBVR   | SOT-23       | DBV             | 5    | 3000  | 210.0       | 185.0      | 35.0        |
| TPS7A2030PDBVR   | SOT-23       | DBV             | 5    | 3000  | 210.0       | 185.0      | 35.0        |
| TPS7A2030PDQNR   | X2SON        | DQN             | 4    | 3000  | 184.0       | 184.0      | 19.0        |
| TPS7A2031PDBVR   | SOT-23       | DBV             | 5    | 3000  | 210.0       | 185.0      | 35.0        |
| TPS7A2031PDBVR   | SOT-23       | DBV             | 5    | 3000  | 180.0       | 180.0      | 18.0        |
| TPS7A2032PDBVR   | SOT-23       | DBV             | 5    | 3000  | 180.0       | 180.0      | 18.0        |
| TPS7A2032PDBVR   | SOT-23       | DBV             | 5    | 3000  | 210.0       | 185.0      | 35.0        |
| TPS7A2033PDBVR   | SOT-23       | DBV             | 5    | 3000  | 210.0       | 185.0      | 35.0        |
| TPS7A2033PDBVR   | SOT-23       | DBV             | 5    | 3000  | 210.0       | 185.0      | 35.0        |
| TPS7A2033PDQNR   | X2SON        | DQN             | 4    | 3000  | 205.0       | 200.0      | 33.0        |
| TPS7A2033PDQNR   | X2SON        | DQN             | 4    | 3000  | 184.0       | 184.0      | 19.0        |



| Device         | Package Type | Package Drawing | Pins | SPQ   | Length (mm) | Width (mm) | Height (mm) |
|----------------|--------------|-----------------|------|-------|-------------|------------|-------------|
| TPS7A2033PYCJR | DSBGA        | YCJ             | 4    | 12000 | 182.0       | 182.0      | 20.0        |
| TPS7A2033PYCJR | DSBGA        | YCJ             | 4    | 12000 | 210.0       | 185.0      | 35.0        |
| TPS7A2036PDBVR | SOT-23       | DBV             | 5    | 3000  | 180.0       | 180.0      | 18.0        |
| TPS7A2036PDBVR | SOT-23       | DBV             | 5    | 3000  | 210.0       | 185.0      | 35.0        |
| TPS7A2036PDQNR | X2SON        | DQN             | 4    | 3000  | 184.0       | 184.0      | 19.0        |
| TPS7A2040PDQNR | X2SON        | DQN             | 4    | 3000  | 184.0       | 184.0      | 19.0        |
| TPS7A2042PDBVR | SOT-23       | DBV             | 5    | 3000  | 180.0       | 180.0      | 18.0        |
| TPS7A2042PDBVR | SOT-23       | DBV             | 5    | 3000  | 210.0       | 185.0      | 35.0        |
| TPS7A2042PDQNR | X2SON        | DQN             | 4    | 3000  | 184.0       | 184.0      | 19.0        |
| TPS7A2045PDBVR | SOT-23       | DBV             | 5    | 3000  | 210.0       | 185.0      | 35.0        |
| TPS7A2045PDBVR | SOT-23       | DBV             | 5    | 3000  | 180.0       | 180.0      | 18.0        |
| TPS7A2045PDQNR | X2SON        | DQN             | 4    | 3000  | 184.0       | 184.0      | 19.0        |
| TPS7A2050PDBVR | SOT-23       | DBV             | 5    | 3000  | 210.0       | 185.0      | 35.0        |
| TPS7A2050PDBVR | SOT-23       | DBV             | 5    | 3000  | 210.0       | 185.0      | 35.0        |
| TPS7A2050PDQNR | X2SON        | DQN             | 4    | 3000  | 184.0       | 184.0      | 19.0        |
| TPS7A2050PYCKR | DSBGA        | YCK             | 4    | 12000 | 182.0       | 182.0      | 20.0        |
| TPS7A2050PYCKR | DSBGA        | YCK             | 4    | 12000 | 210.0       | 185.0      | 35.0        |
| TPS7A2055PDBVR | SOT-23       | DBV             | 5    | 3000  | 180.0       | 180.0      | 18.0        |
| TPS7A2055PDBVR | SOT-23       | DBV             | 5    | 3000  | 210.0       | 185.0      | 35.0        |



# EXAMPLE BOARD LAYOUT

DBV0005A

SOT-23 - 1.45 mm max height

SMALL OUTLINE TRANSISTOR



LAND PATTERN EXAMPLE  
EXPOSED METAL SHOWN  
SCALE:15X



SOLDER MASK DETAILS

4214839/F 06/2021

NOTES: (continued)

- 5. Publication IPC-7351 may have alternate designs.
- 6. Solder mask tolerances between and around signal pads can vary based on board fabrication site.

# EXAMPLE STENCIL DESIGN

DBV0005A

SOT-23 - 1.45 mm max height

SMALL OUTLINE TRANSISTOR



SOLDER PASTE EXAMPLE  
BASED ON 0.125 mm THICK STENCIL  
SCALE:15X

4214839/F 06/2021

NOTES: (continued)

7. Laser cutting apertures with trapezoidal walls and rounded corners may offer better paste release. IPC-7525 may have alternate design recommendations.
8. Board assembly site may have different recommendations for stencil design.

## GENERIC PACKAGE VIEW

DQN 4

**X2SON - 0.4 mm max height**

PLASTIC SMALL OUTLINE - NO LEAD



Images above are just a representation of the package family, actual package may vary.  
Refer to the product data sheet for package details.

4210367/F

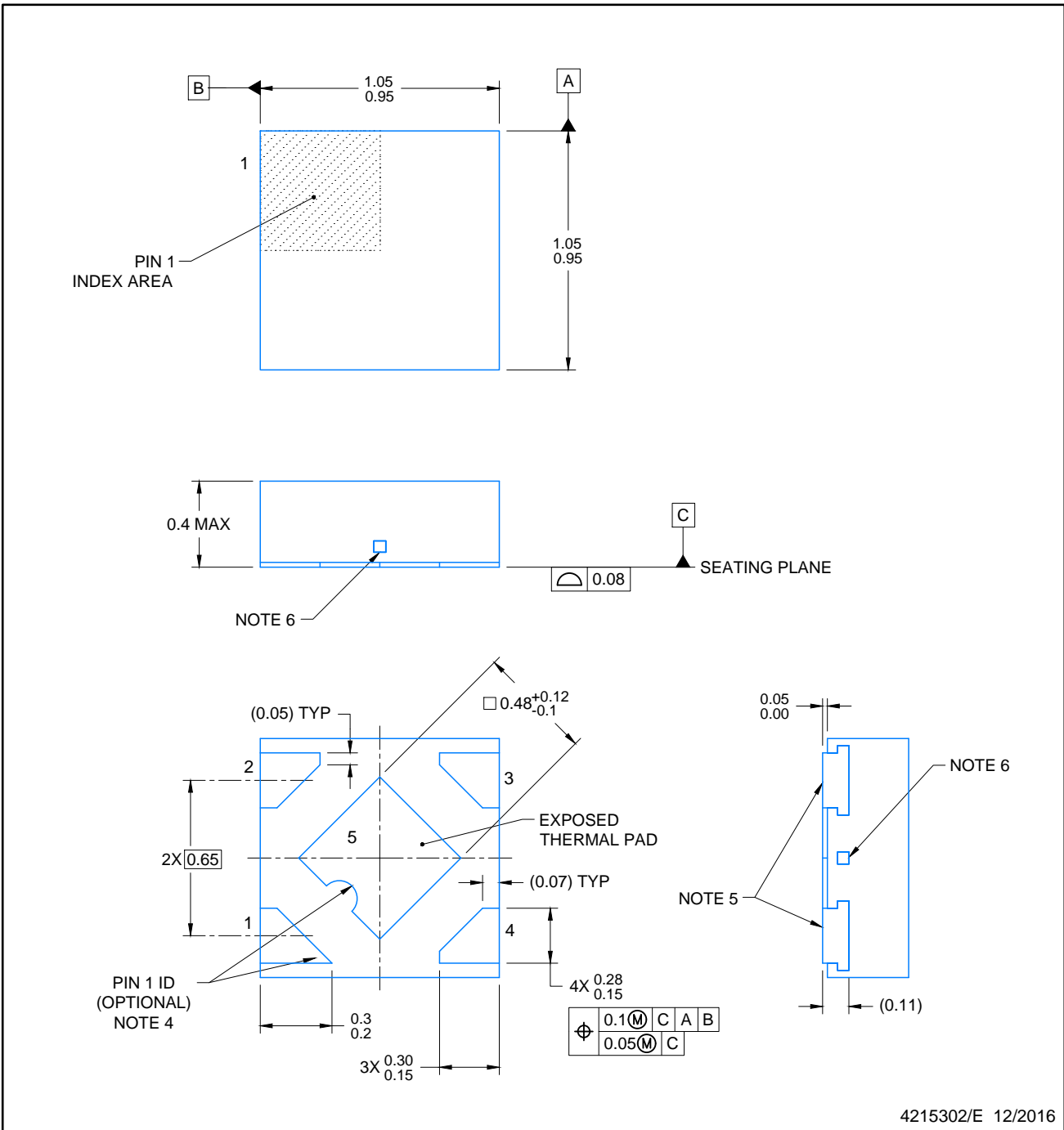

4215302/E 12/2016

NOTES:

1. All linear dimensions are in millimeters. Any dimensions in parenthesis are for reference only. Dimensioning and tolerancing per ASME Y14.5M.
2. This drawing is subject to change without notice.
3. The package thermal pad must be soldered to the printed circuit board for optimal thermal and mechanical performance.
4. Features may not exist. Recommend use of pin 1 marking on top of package for orientation purposes.
5. Shape of exposed side leads may differ.
6. Number and location of exposed tie bars may vary.

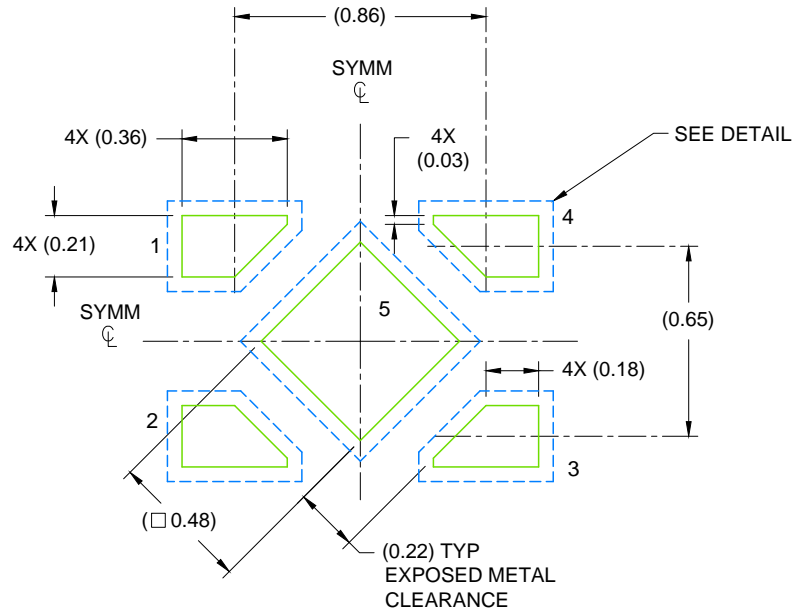

LAND PATTERN EXAMPLE  
SCALE: 40X

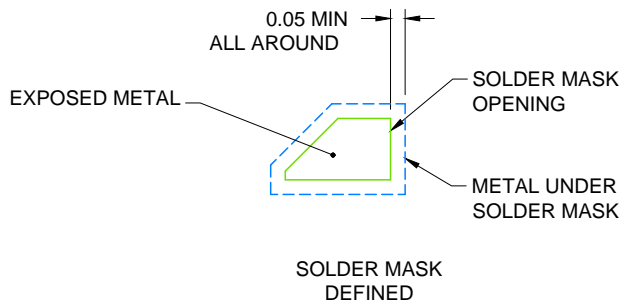

SOLDER MASK DETAIL

4215302/E 12/2016

NOTES: (continued)

7. This package is designed to be soldered to a thermal pad on the board. For more information, see Texas Instruments literature number SLUA271 ([www.ti.com/lit/sluea271](http://www.ti.com/lit/sluea271)).
8. If any vias are implemented, it is recommended that vias under paste be filled, plugged or tented.

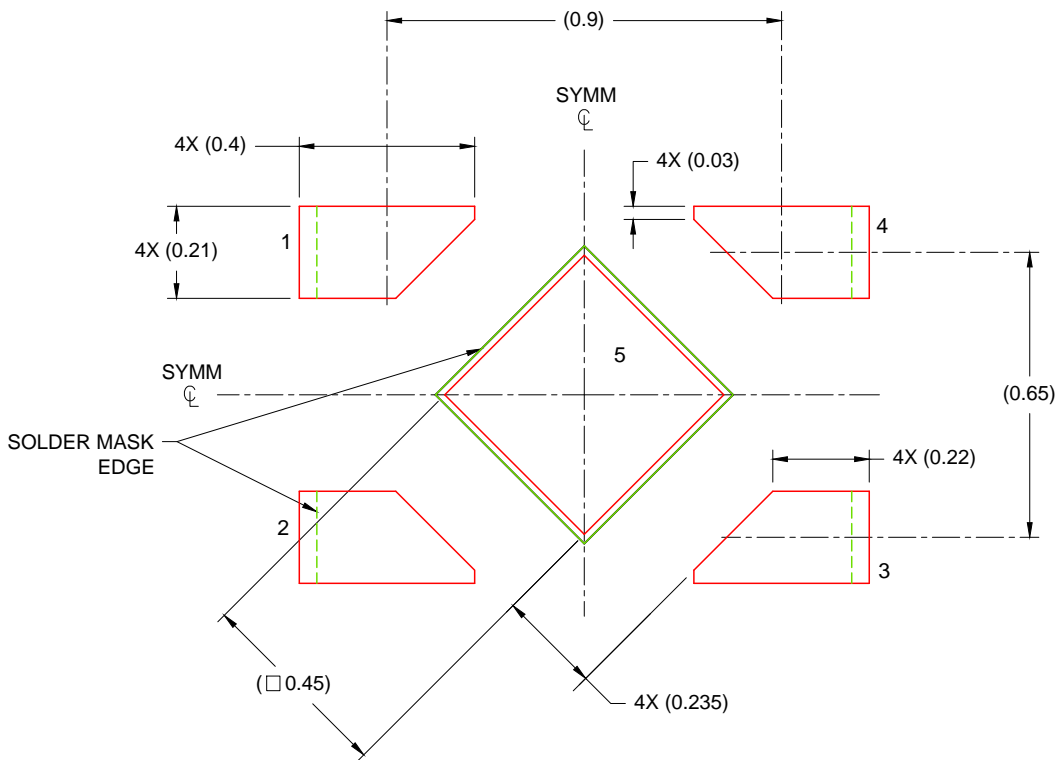

SOLDER PASTE EXAMPLE  
 BASED ON 0.075 - 0.1mm THICK STENCIL  
 EXPOSED PAD  
 88% PRINTED SOLDER COVERAGE BY AREA  
 SCALE: 60X

4215302/E 12/2016

NOTES: (continued)

9. Laser cutting apertures with trapezoidal walls and rounded corners may offer better paste release. IPC-7525 may have alternate design recommendations.



## 重要声明和免责声明

TI“按原样”提供技术和可靠性数据（包括数据表）、设计资源（包括参考设计）、应用或其他设计建议、网络工具、安全信息和其他资源，不保证没有瑕疵且不做任何明示或暗示的担保，包括但不限于对适销性、某特定用途方面的适用性或不侵犯任何第三方知识产权的暗示担保。

这些资源可供使用 TI 产品进行设计的熟练开发人员使用。您将自行承担以下全部责任：(1) 针对您的应用选择合适的 TI 产品，(2) 设计、验证并测试您的应用，(3) 确保您的应用满足相应标准以及任何其他功能安全、信息安全、监管或其他要求。

这些资源如有变更，恕不另行通知。TI 授权您仅可将这些资源用于研发本资源所述的 TI 产品的应用。严禁对这些资源进行其他复制或展示。您无权使用任何其他 TI 知识产权或任何第三方知识产权。您应全额赔偿因在这些资源的使用中对 TI 及其代表造成的任何索赔、损害、成本、损失和债务，TI 对此概不负责。

TI 提供的产品受 [TI 的销售条款](#) 或 [ti.com](#) 上其他适用条款/TI 产品随附的其他适用条款的约束。TI 提供这些资源并不会扩展或以其他方式更改 TI 针对 TI 产品发布的适用的担保或担保免责声明。

TI 反对并拒绝您可能提出的任何其他或不同的条款。

邮寄地址：Texas Instruments, Post Office Box 655303, Dallas, Texas 75265

Copyright © 2023，德州仪器 (TI) 公司

## X-ON Electronics

Largest Supplier of Electrical and Electronic Components

*Click to view similar products for [LDO Voltage Regulators](#) category:*

*Click to view products by [Texas Instruments](#) manufacturer:*

Other Similar products are found below :

[AP7363-SP-13](#) [NCV8664CST33T3G](#) [L79M05TL-E](#) [AP7362-HA-7](#) [PT7M8202B12TA5EX](#) [TCR3DF185,LM\(CT](#) [TLF4949EJ](#)  
[NCP4687DH15T1G](#) [NCV8703MX30TCG](#) [LP2951CN](#) [NCV4269CPD50R2G](#) [AP7315-25W5-7](#) [NCV47411PAAJR2G](#) [AP2111H-1.2TRG1](#)  
[ZLDO1117QK50TC](#) [AZ1117ID-ADJTRG1](#) [NCV4263-2CPD50R2G](#) [NCP114BMX075TCG](#) [MC33269T-3.5G](#) [TLE4471GXT](#) [AP7315-33SA-](#)  
[7](#) [NCV4266-2CST33T3G](#) [NCP715SQ15T2G](#) [NCV8623MN-50R2G](#) [NCV563SQ18T1G](#) [NCV8664CDT33RKG](#) [NCV4299CD250R2G](#)  
[NCP715MX30TBG](#) [NCV8702MX25TCG](#) [TLE7270-2E](#) [NCV562SQ25T1G](#) [AP2213D-3.3TRG1](#) [AP2202K-2.6TRE1](#)  
[NCV8170BMX300TCG](#) [NCV8152MX300180TCG](#) [NCP700CMT45TBG](#) [AP7315-33W5-7](#) [NCP154MX180300TAG](#) [AP2113AMTR-G1](#)  
[NJV4104U2-33A-TE1](#) [MP2013AGG-5-P](#) [NCV8775CDT50RKG](#) [NJM2878F3-45-TE1](#) [S-19214B00A-V5T2U7](#) [S-19214B50A-V5T2U7](#) [S-](#)  
[19213B50A-V5T2U7](#) [S-19214BC0A-E8T1U7\\*1](#) [S-19213B00A-V5T2U7](#) [S-19213B33A-V5T2U7](#) [S-19213BC0A-V5T2U7](#)