

# TPS7A53 3A、高精度 (0.5%)、低噪声 (4.4 $\mu$ V<sub>RMS</sub>) LDO 稳压器

## 1 特性

- 线路、负载和温度范围内的最大精度为 0.5%，有偏置
- 输出电压噪声：4.4 $\mu$ V<sub>RMS</sub>
- 低压降：3A 电流时为 110mV（最大值，有偏置）
- 电源抑制比：
  - 500kHz 时为 40dB
- 输入电压范围：
  - 无偏置：1.4V 至 6.5V
  - 有偏置：1.1V 至 6.5V
- 可调节输出电压范围：0.8V 至 5.2V
- 可调软启动浪涌控制
- 开漏电源正常状态 (PG) 输出
- 2.2mm × 2.5mm 12 引脚 VQFN 封装

## 2 应用

- 宏远程无线电单元 (RRU)
- 室外回程单元
- 有源天线系统 mMIMO (AAS)
- 超声波扫描仪
- 实验室和现场仪表
- 传感器、成像和雷达

## 3 说明

TPS7A53 是一款低噪声 (4.4 $\mu$ V<sub>RMS</sub>)、超低压降线性稳压器 (LDO)，可提供 3A 电流，最大压降仅为 110mV。该器件的输出电压可通过外部电阻分压器进行调节，范围为 0.8V 至 5.2V。

TPS7A53 集低噪声 (4.4 $\mu$ V<sub>RMS</sub>)、高 PSRR 和高输出电流能力等特性于一体，非常适合为高速通信、视频、医疗或测试和测量应用中的噪声敏感型组件供电。该器件具有高性能，可抑制电源产生的相位噪声和时钟抖动，因此非常适合为高性能串行器和解串器 (SerDes)、模数转换器 (ADC) 和数模转换器 (DAC) 供电。该器件具有高性能和高达 5.2V 的输出能力，尤其适合射频放大器使用。

对于需要以低输入和低输出 (LILO) 电压运行的数字负载（例如专用集成电路 (ASIC)、现场可编程门阵列 (FPGA) 和数字信号处理器 (DSP)），TPS7A53 所具备的出色精度（在负载和温度范围内可达 0.5%）、遥感功能、出色的瞬态性能和软启动功能可实现出色的系统性能。

作为可调节稳压器，TPS7A53 可实现多用途设计，因此适用于 VCO、ADC、DAC 和成像传感器等模拟负载以及串行器/解串器、FPGA 和 DSP 等数字负载。

### 器件信息<sup>(1)</sup>

器件型号	封装	封装尺寸 (标称值)
TPS7A53	VQFN (12)	2.20mm × 2.50mm

(1) 如需了解所有可用封装，请参阅产品说明书末尾的封装选项附录。

为射频组件供电

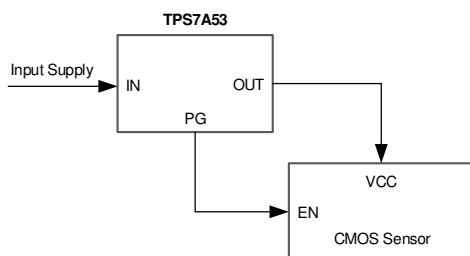

为数字负载供电

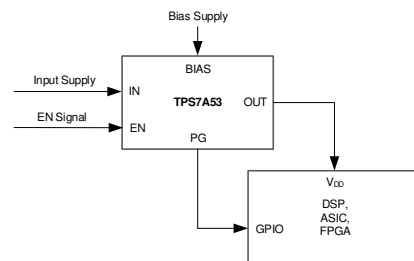

## 目录

<b>1</b>	特性 .....	<b>1</b>	<b>8</b>	<b>Application and Implementation</b> .....	<b>20</b>
<b>2</b>	应用 .....	<b>1</b>	8.1	Application Information.....	20
<b>3</b>	说明 .....	<b>1</b>	8.2	Typical Application .....	31
<b>4</b>	修订历史记录 .....	<b>2</b>	<b>9</b>	<b>Power Supply Recommendations</b> .....	<b>32</b>
<b>5</b>	<b>Pin Configuration and Functions</b> .....	<b>3</b>	<b>10</b>	<b>Layout</b> .....	<b>32</b>
<b>6</b>	<b>Specifications</b> .....	<b>4</b>	10.1	Layout Guidelines .....	32
6.1	Absolute Maximum Ratings .....	4	10.2	Layout Example .....	33
6.2	ESD Ratings.....	4	<b>11</b>	<b>器件和文档支持</b> .....	<b>34</b>
6.3	Recommended Operating Conditions.....	4	11.1	器件支持 .....	34
6.4	Thermal Information .....	5	11.2	文档支持 .....	34
6.5	Electrical Characteristics.....	5	11.3	接收文档更新通知 .....	34
6.6	Typical Characteristics .....	8	11.4	社区资源 .....	34
<b>7</b>	<b>Detailed Description</b> .....	<b>15</b>	11.5	商标 .....	35
7.1	Overview .....	15	11.6	静电放电警告 .....	35
7.2	Functional Block Diagram .....	15	11.7	Glossary .....	35
7.3	Feature Description.....	16	<b>12</b>	<b>机械、封装和可订购信息</b> .....	<b>36</b>
7.4	Device Functional Modes.....	19			

## 4 修订历史记录

注：之前版本的页码可能与当前版本有所不同。

<b>Changes from Original (November 2019) to Revision A</b>	<b>Page</b>
• 已更改 将文档状态从“预告信息”更改为“生产数据” .....	<b>1</b>

## 5 Pin Configuration and Functions

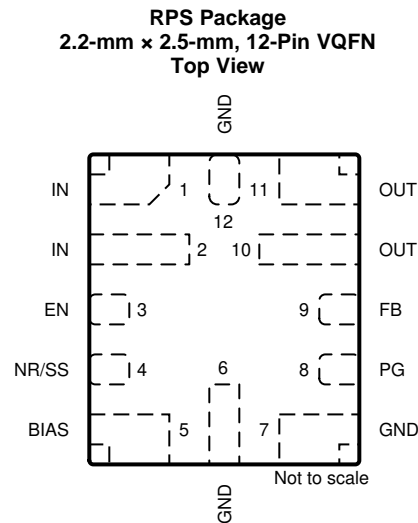

### Pin Functions

PIN			DESCRIPTION
NAME	NO.	I/O	
BIAS	5	I	BIAS supply voltage. This pin enables the use of low-input voltage, low-output (LLO) voltage conditions (that is, $V_{IN} = 1.2\text{ V}$ , $V_{OUT} = 1\text{ V}$ ) to reduce power dissipation across the die. The use of a BIAS voltage improves dc and ac performance for $V_{IN} \leq 2.2\text{ V}$ . A 10- $\mu\text{F}$ capacitor or larger must be connected between this pin and ground. If not used, this pin must be left floating or tied to ground.
EN	3	I	Enable pin. Driving this pin to logic high enables the device; driving this pin to logic low disables the device. If enable functionality is not required, this pin must be connected to IN or BIAS.
FB	9	I	Feedback pin connected to the error amplifier. Although not required, a 10-nF feed-forward capacitor from FB to OUT (as close to the device as possible) is recommended to maximize ac performance. The use of a feed-forward capacitor can disrupt PG (power good) functionality.
GND	6, 7, 12	—	Ground pin. These pins must be connected to ground, the thermal pad, and each other with a low-impedance connection.
IN	1, 2	I	Input supply voltage pin. A 10- $\mu\text{F}$ or larger ceramic capacitor (5 $\mu\text{F}$ or greater of capacitance) from IN to ground is recommended to reduce the impedance of the input supply. Place the input capacitor as close to the input as possible.
NR/SS	4	—	Noise-reduction and soft-start pin. Connecting an external capacitor between this pin and ground reduces reference voltage noise and also enables the soft-start function. Although not required, a 10-nF or larger capacitor is recommended to be connected from NR/SS to GND (as close to the pin as possible) to maximize ac performance.
OUT	10, 11	O	Regulated output pin. A 47- $\mu\text{F}$ or larger ceramic capacitor (25 $\mu\text{F}$ or greater of capacitance) from OUT to ground is required for stability and must be placed as close to the output as possible. Minimize the impedance from the OUT pin to the load.
PG	8	O	Active-high, power-good pin. An open-drain output indicates when the output voltage reaches $V_{IT(PG)}$ of the target. The use of a feed-forward capacitor can disrupt PG (power good) functionality.

## 6 Specifications

### 6.1 Absolute Maximum Ratings

over operating free-air temperature range (unless otherwise noted)<sup>(1)</sup>

		MIN	MAX	UNIT
Voltage	IN, BIAS, PG, EN	-0.3	7.0	V
	SNS, OUT	-0.3	$V_{IN} + 0.3^{(2)}$	
	NR/SS, FB	-0.3	3.6	
Current	OUT	Internally limited		A
	PG (sink current into device)		5	mA
Temperature	Operating junction, $T_J$	-55	125	°C
	Storage, $T_{stg}$	-55	150	

- (1) Stresses beyond those listed under *Absolute Maximum Rating* may cause permanent damage to the device. These are stress ratings only, which do not imply functional operation of the device at these or any other conditions beyond those indicated under *Recommended Operating Condition*. Exposure to absolute-maximum-rated conditions for extended periods may affect device reliability.
- (2) The absolute maximum rating is  $V_{IN} + 0.3$  V or 7.0 V, whichever is smaller.

### 6.2 ESD Ratings

			VALUE	UNIT
$V_{(ESD)}$	Electrostatic discharge	Human body model (HBM), per ANSI/ESDA/JEDEC JS-001, all pins <sup>(1)</sup>	±2000	V
		Charged device model (CDM), per JEDEC specification JESD22-C101, all pins <sup>(2)</sup>	±500	

- (1) JEDEC document JEP155 states that 500-V HBM allows safe manufacturing with a standard ESD control process.
- (2) JEDEC document JEP157 states that 250-V CDM allows safe manufacturing with a standard ESD control process.

### 6.3 Recommended Operating Conditions

over operating junction temperature range (unless otherwise noted)

		MIN	NOM	MAX	UNIT
$V_{IN}$	Input supply voltage range	1.1		6.5	V
$V_{BIAS}$	Bias supply voltage range	3.0		6.5	V
$V_{OUT}$	Output voltage range <sup>(1)</sup>	0.8		5.15	V
$V_{EN}$	Enable voltage range	0		6.5	V
$I_{OUT}$	Output current	0		4	A
$C_{IN}$	Input capacitor	22	47	3000	μF
$C_{OUT}$	Output capacitor	22	47	3000	μF
$R_{PG}$	Power-good pullup resistance	1		100	kΩ
$C_{NR/SS}$	NR/SS capacitor		10		nF
$C_{FF}$	Feed-forward capacitor		10		nF
$R_1$	Top resistor value in feedback network for adjustable operation		12.1		kΩ
$R_2$	Bottom resistor value in feedback network for adjustable operation			160 <sup>(2)</sup>	kΩ
$T_J$	Operating junction temperature	-40		125	°C

- (1) This output voltage range does not include device accuracy or accuracy of the feedback resistors.
- (2) The upper limit for the  $R_2$  resistor is to ensure accuracy by making the current through the feedback network much larger than the leakage current into the feedback node.

## 6.4 Thermal Information

THERMAL METRIC <sup>(1)</sup>		TPS7A53		UNIT
		RPS (VQFN) <sup>(2)</sup>	RPS (VQFN) <sup>(3)</sup>	
		12 PINS	12 PINS	
R <sub>θJA</sub>	Junction-to-ambient thermal resistance	68.7	46.5	°C/W
R <sub>θJC(top)</sub>	Junction-to-case (top) thermal resistance	43.8	43.8	°C/W
R <sub>θJB</sub>	Junction-to-board thermal resistance	19.3	N/A	°C/W
Ψ <sub>JT</sub>	Junction-to-top characterization parameter	1.3	4.5	°C/W
Ψ <sub>JB</sub>	Junction-to-board characterization parameter	18.9	22	°C/W
R <sub>θJC(bot)</sub>	Junction-to-case (bottom) thermal resistance	4.2	11.4	°C/W

(1) For more information about traditional and new thermal metrics, see the [Semiconductor and IC Package Thermal Metrics](#) application report.

(2) JEDEC standard. (2s2p, no vias to internal plane and bottom layer)

(3) EVM model.

## 6.5 Electrical Characteristics

over operating junction temperature range ( $T_J = -40^\circ\text{C}$  to  $+125^\circ\text{C}$ ),  $V_{IN} = 1.4\text{ V}$  or  $V_{IN} = V_{OUT(nom)} + 0.5\text{ V}$  (whichever is greater),  $V_{BIAS} = \text{open}$ ,  $V_{OUT(nom)} = 0.8\text{ V}^{(1)}$ , OUT connected to  $50\ \Omega$  to GND,  $V_{EN} = 1.1\text{ V}$ ,  $C_{IN} = 10\ \mu\text{F}$ ,  $C_{OUT} = 47\ \mu\text{F}$ ,  $C_{NR/SS} = 0\text{ nF}$ ,  $C_{FF} = 0\text{ nF}$ , and PG pin pulled up to  $V_{IN}$  with  $100\text{ k}\Omega$  (unless otherwise noted); typical values are at  $T_J = 25^\circ\text{C}$

PARAMETER		TEST CONDITIONS	MIN	TYP	MAX	UNIT
V <sub>FB</sub>	Feedback voltage			0.8		V
V <sub>NR/SS</sub>	NR/SS pin voltage			0.8		V
V <sub>UVLO+(IN)</sub>	Rising input supply UVLO with BIAS	V <sub>IN</sub> rising with V <sub>BIAS</sub> = 3 V		1.02	1.085	V
V <sub>UVLO-(IN)</sub>	Falling input supply UVLO with BIAS	V <sub>IN</sub> falling with V <sub>BIAS</sub> = 3 V	0.55	0.7		V
V <sub>UVLO+(IN)</sub>	Rising input supply UVLO without BIAS	V <sub>IN</sub> rising		1.31	1.39	V
V <sub>UVLO-(IN)</sub>	Falling input supply UVLO without BIAS	V <sub>IN</sub> falling	0.65	1.057		V
V <sub>UVLO+(BIAS)</sub>	Rising bias supply UVLO	V <sub>BIAS</sub> rising, V <sub>IN</sub> = 1.1 V		2.83	2.9	V
V <sub>UVLO-(BIAS)</sub>	Falling bias supply UVLO	V <sub>BIAS</sub> falling, V <sub>IN</sub> = 1.1 V	2.45	2.54		V
V <sub>OUT</sub>	Output voltage range		0.8		5.15	V
	Output voltage accuracy	1.4 V ≤ V <sub>IN</sub> ≤ 6.5 V, 0.8 V ≤ V <sub>OUT</sub> ≤ 5.15 V, 5 mA ≤ I <sub>OUT</sub> ≤ 3 A	-0.75		0.75	%
		V <sub>IN</sub> = 1.1 V, 5 mA ≤ I <sub>OUT</sub> ≤ 3 A, 3 V ≤ V <sub>BIAS</sub> ≤ 6.5 V	-0.5		0.5	%
DV <sub>OUT</sub> /ΔV <sub>IN</sub>	Line regulation	I <sub>OUT</sub> = 5 mA, 1.4 V ≤ V <sub>IN</sub> ≤ 6.5 V		0.03		mV/V
DV <sub>OUT</sub> /ΔV <sub>IN</sub>	Load regulation	5 mA ≤ I <sub>OUT</sub> ≤ 3 A 3 V ≤ V <sub>BIAS</sub> ≤ 6.5 V V <sub>IN</sub> = 1.1 V		0.07		mV/A
DV <sub>OUT</sub> /ΔV <sub>IN</sub>	Load regulation	5 mA ≤ I <sub>OUT</sub> ≤ 3 A		0.012		mV/A
V <sub>OS</sub>	Error amplifier offset voltage	V <sub>IN</sub> = 1.4 V, I <sub>OUT</sub> = 5 mA; -40 °C ≤ T <sub>J</sub> ≤ +125 °C	-2.5		2.5	mV

(1) V<sub>OUT(nom)</sub> is the calculated V<sub>OUT</sub> target value from the ANY-OUT in a fixed configuration. In an adjustable configuration, V<sub>OUT(nom)</sub> is the expected V<sub>OUT</sub> value set by the external feedback resistors.

**Electrical Characteristics (continued)**

over operating junction temperature range ( $T_J = -40^\circ\text{C}$  to  $+125^\circ\text{C}$ ),  $V_{IN} = 1.4\text{ V}$  or  $V_{IN} = V_{OUT(nom)} + 0.5\text{ V}$  (whichever is greater),  $V_{BIAS} = \text{open}$ ,  $V_{OUT(nom)} = 0.8\text{ V}^{(1)}$ , OUT connected to  $50\ \Omega$  to GND,  $V_{EN} = 1.1\text{ V}$ ,  $C_{IN} = 10\ \mu\text{F}$ ,  $C_{OUT} = 47\ \mu\text{F}$ ,  $C_{NR/SS} = 0\text{ nF}$ ,  $C_{FF} = 0\text{ nF}$ , and PG pin pulled up to  $V_{IN}$  with  $100\text{ k}\Omega$  (unless otherwise noted); typical values are at  $T_J = 25^\circ\text{C}$

PARAMETER	TEST CONDITIONS	MIN	TYP	MAX	UNIT	
$V_{DO}$	Dropout voltage	$V_{IN} = 1.4\text{ V}$ , $I_{OUT} = 3\text{ A}$ , $V_{FB} = 0.8\text{ V} - 3\%$		105	175	mV
		$V_{IN} = 5.4\text{ V}$ , $I_{OUT} = 3\text{ A}$ , $V_{FB} = 0.8\text{ V} - 3\%$		170	280	
		$V_{IN} = 5.6\text{ V}$ , $I_{OUT} = 3\text{ A}$ , $V_{FB} = 0.8\text{ V} - 3\%$		215	375	
		$V_{IN} = 1.1\text{ V}$ , $3.0\text{ V} \leq V_{BIAS} \leq 6.5\text{ V}$ , $I_{OUT} = 3\text{ A}$ , $V_{FB} = 0.8\text{ V} - 3\%$		60	110	
$I_{LIM}$	Output current limit	$V_{OUT}$ forced at $0.9 \times V_{OUT(nom)}$ , $V_{IN} = V_{OUT(nom)} + 0.4\text{ V}$	3.6	4.2	4.9	A
$I_{SC}$	Short-circuit current limit	$R_{LOAD} = 20\text{ m}\Omega$		2		
$I_{GND}$	GND pin current	$V_{IN} = 6.5\text{ V}$ , $I_{OUT} = 5\text{ mA}$		2.8	4	mA
		$V_{IN} = 1.4\text{ V}$ , $I_{OUT} = 3\text{ A}$		4.8	5.5	
		Shutdown, PG = open, $V_{IN} = 6.5\text{ V}$ , $V_{EN} = 0.5\text{ V}$				25
$I_{EN}$	EN pin current	$V_{IN} = 6.5\text{ V}$ , $V_{EN} = 0\text{ V}$ and $6.5\text{ V}$			0.5	$\mu\text{A}$
$I_{BIAS}$	BIAS pin current	$V_{IN} = 1.1\text{ V}$ , $V_{BIAS} = 6.5\text{ V}$ , $V_{OUT(nom)} = 0.8\text{ V}$ , $I_{OUT} = 3\text{ A}$		2.3	3.5	mA
$V_{IL(EN)}$	EN pin low-level input voltage (disable device)		0		0.5	V
$V_{IH(EN)}$	EN pin high-level input voltage (enable device)		1.1		6.5	V
$V_{IT(PG)}$	Falling PG pin threshold	For falling $V_{OUT}$	$82\% \times V_{OUT}$	$88.3\% \times V_{OUT}$	$93\% \times V_{OUT}$	V
$V_{IT+(PG)}$	Rising PG pin threshold	For rising $V_{OUT}$	$84\% \times V_{OUT}$	$89.3\% \times V_{OUT}$	$95\% \times V_{OUT}$	V
$V_{OL(PG)}$	PG pin low-level output voltage	$V_{OUT} < V_{IT(PG)}$ , $I_{PG} = -1\text{ mA}$ (current into device)			0.4	V
$I_{IKG(PG)}$	PG pin leakage current	$V_{OUT} > V_{IT(PG)}$ , $V_{PG} = 6.5\text{ V}$			1	$\mu\text{A}$
$I_{NR/SS}$	NR/SS pin charging current	$V_{NR/SS} = \text{GND}$ , $V_{IN} = 6.5\text{ V}$	4	6.2	9	$\mu\text{A}$
$I_{FB}$	FB pin leakage current	$V_{IN} = 6.5\text{ V}$			100	nA
$R_{NR}$	NR resistor value			250		k $\Omega$
PSRR	Power-supply rejection ratio	$V_{IN} - V_{OUT} = 0.4\text{ V}$ , $V_{OUT} = 0.8\text{ V}$ , $V_{BIAS} = 5\text{ V}$ , $I_{OUT} = 3\text{ A}$ , $C_{NR/SS} = 10\text{ nF}$ , $C_{FF} = 10\text{ nF}$ , $C_{OUT} = 47\ \mu\text{F} \parallel 10\ \mu\text{F} \parallel 10\ \mu\text{F}$ , $f = 10\text{ kHz}$		35		dB
		$V_{IN} - V_{OUT} = 0.4\text{ V}$ , $V_{OUT} = 0.8\text{ V}$ , $V_{BIAS} = 5\text{ V}$ , $I_{OUT} = 3\text{ A}$ , $C_{NR/SS} = 10\text{ nF}$ , $C_{FF} = 10\text{ nF}$ , $C_{OUT} = 47\ \mu\text{F} \parallel 10\ \mu\text{F} \parallel 10\ \mu\text{F}$ , $f = 500\text{ kHz}$		44		

**Electrical Characteristics (continued)**

over operating junction temperature range ( $T_J = -40^\circ\text{C}$  to  $+125^\circ\text{C}$ ),  $V_{IN} = 1.4\text{ V}$  or  $V_{IN} = V_{OUT(nom)} + 0.5\text{ V}$  (whichever is greater),  $V_{BIAS} = \text{open}$ ,  $V_{OUT(nom)} = 0.8\text{ V}^{(1)}$ , OUT connected to  $50\ \Omega$  to GND,  $V_{EN} = 1.1\text{ V}$ ,  $C_{IN} = 10\ \mu\text{F}$ ,  $C_{OUT} = 47\ \mu\text{F}$ ,  $C_{NR/SS} = 0\text{ nF}$ ,  $C_{FF} = 0\text{ nF}$ , and PG pin pulled up to  $V_{IN}$  with  $100\text{ k}\Omega$  (unless otherwise noted); typical values are at  $T_J = 25^\circ\text{C}$

PARAMETER	TEST CONDITIONS	MIN	TYP	MAX	UNIT
$V_n$	Output noise voltage	Bandwidth = 10 Hz to 100 kHz, $V_{IN} = 1.1\text{ V}$ , $V_{OUT} = 0.8\text{ V}$ , $V_{BIAS} = 5\text{ V}$ , $I_{OUT} = 3\text{ A}$ , $C_{NR/SS} = 10\text{ nF}$ , $C_{FF} = 10\text{ nF}$ , $C_{OUT} = 47\ \mu\text{F} \parallel 10\ \mu\text{F} \parallel 10\ \mu\text{F}$		4.4	$\mu\text{V}_{\text{RMS}}$
		Bandwidth = 10 Hz to 100 kHz, $V_{OUT} = 5\text{ V}$ , $I_{OUT} = 3\text{ A}$ , $C_{NR/SS} = 10\text{ nF}$ , $C_{FF} = 10\text{ nF}$ , $C_{OUT} = 47\ \mu\text{F} \parallel 10\ \mu\text{F} \parallel 10\ \mu\text{F}$		8.4	
$T_{sd+}$	Thermal shutdown temperature increasing	Shutdown, temperature increasing		160	$^\circ\text{C}$
$T_{sd-}$	Thermal shutdown temperature decreasing	Reset, temperature decreasing		140	

### 6.6 Typical Characteristics

at  $T_A = 25^\circ\text{C}$ ,  $V_{IN} = 1.4\text{ V}$  or  $V_{IN} = V_{OUT(NOM)} + 0.4\text{ V}$  (whichever is greater),  $V_{BIAS} = \text{open}$ ,  $V_{OUT(NOM)} = 0.8\text{ V}$ ,  $V_{EN} = 1.1\text{ V}$ ,  $C_{OUT} = 47\text{ }\mu\text{F}$ ,  $C_{NR/SS} = 0\text{ nF}$ ,  $C_{FF} = 0\text{ nF}$ , and PG pin pulled up to  $V_{IN}$  with  $100\text{ k}\Omega$  (unless otherwise noted)



图 1. PSRR vs Frequency and  $I_{OUT}$



图 2. PSRR vs Frequency and  $V_{IN}$  With Bias

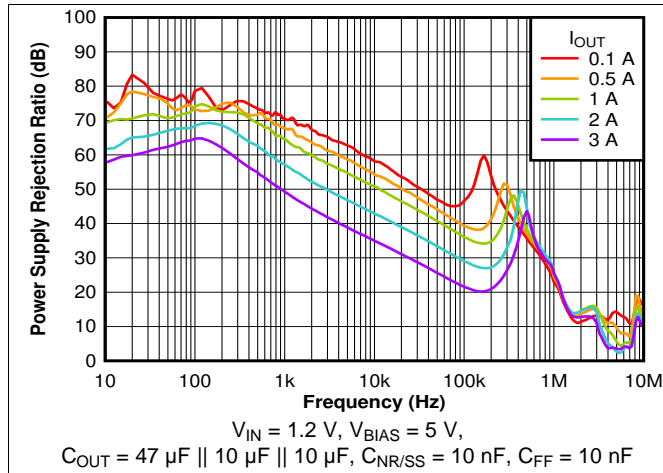

图 3. PSRR vs Frequency and  $V_{BIAS}$

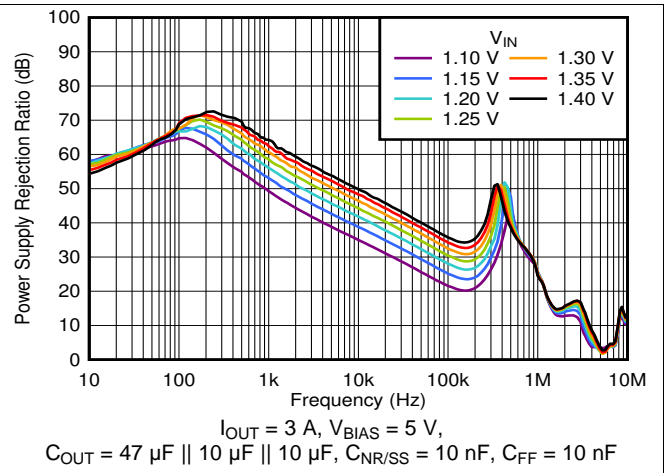

图 4. PSRR vs Frequency and  $V_{IN}$

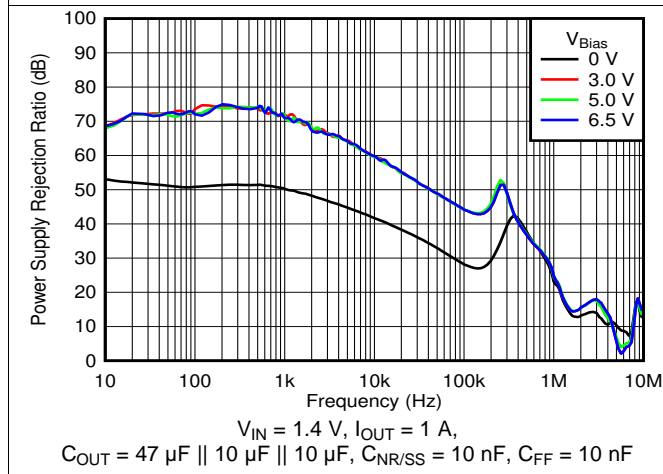

图 5. PSRR vs Frequency and  $V_{OUT}$  With Bias

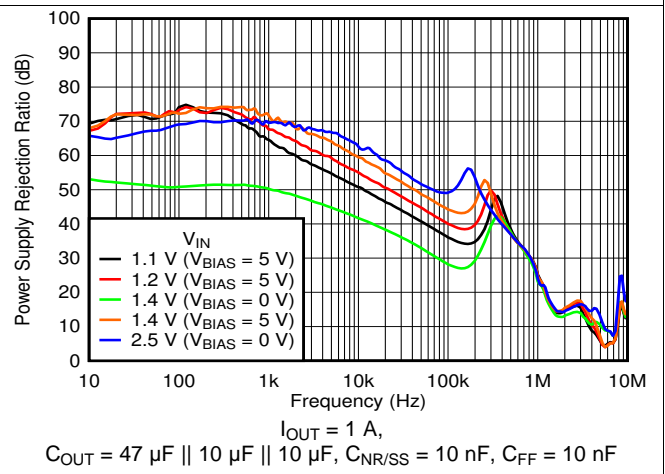

图 6. PSRR vs Frequency and  $V_{IN}$  for  $V_{OUT} = 3.3\text{ V}$

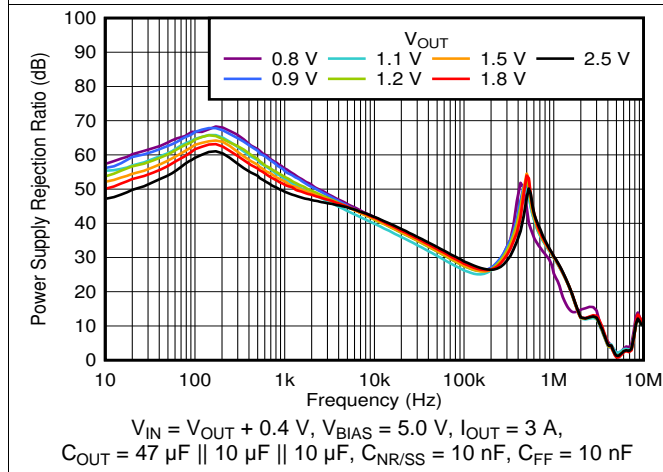

Typical Characteristics (接下页)

at  $T_A = 25^\circ\text{C}$ ,  $V_{IN} = 1.4\text{ V}$  or  $V_{IN} = V_{OUT(NOM)} + 0.4\text{ V}$  (whichever is greater),  $V_{BIAS} = \text{open}$ ,  $V_{OUT(NOM)} = 0.8\text{ V}$ ,  $V_{EN} = 1.1\text{ V}$ ,  $C_{OUT} = 47\text{ }\mu\text{F}$ ,  $C_{NR/SS} = 0\text{ nF}$ ,  $C_{FF} = 0\text{ nF}$ , and PG pin pulled up to  $V_{IN}$  with  $100\text{ k}\Omega$  (unless otherwise noted)

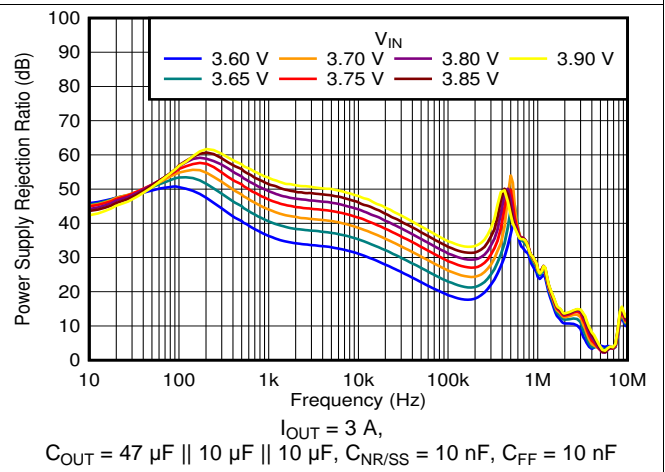

图 7. PSRR vs Frequency and  $C_{OUT}$



图 8. PSRR vs Frequency and  $I_{OUT}$  for  $V_{OUT} = 5\text{ V}$

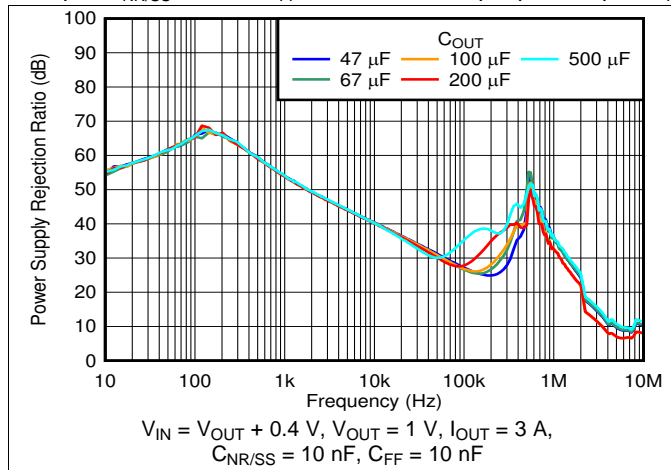

图 9. Output Voltage Noise vs Output Voltage and  $I_{OUT}$

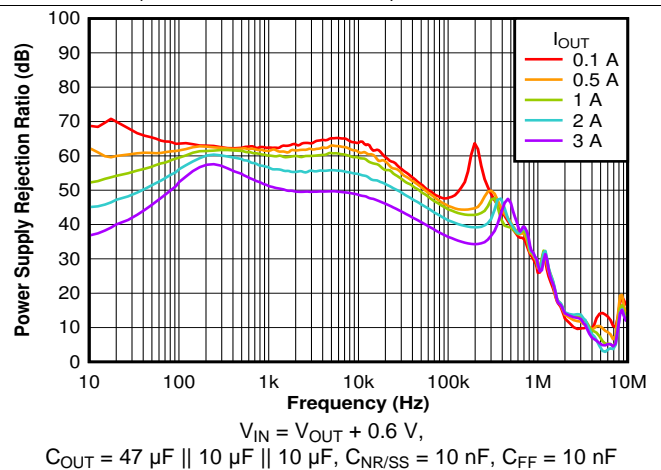

图 10. Output Voltage Noise vs Frequency and  $V_{OUT}$

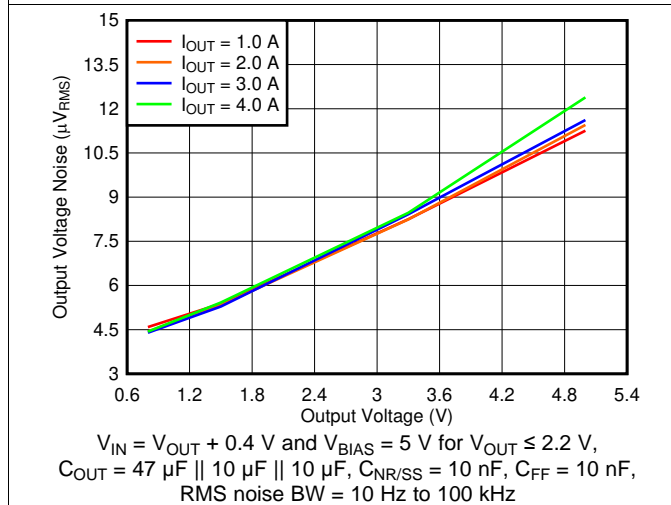

图 11. Output Voltage Noise vs Frequency and  $V_{IN}$

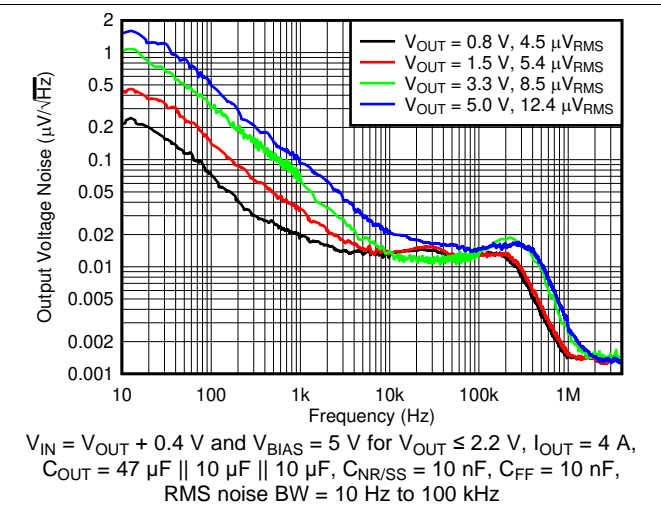

图 12. Output Voltage Noise vs Frequency and  $C_{NR/SS}$

Typical Characteristics (接下页)

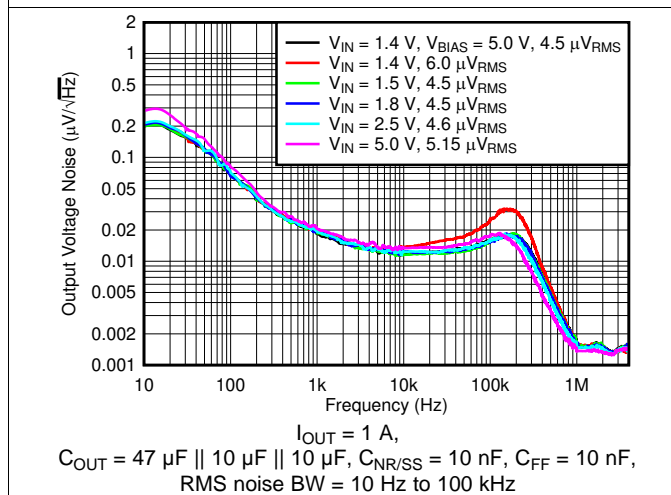
at  $T_A = 25^\circ\text{C}$ ,  $V_{IN} = 1.4\text{ V}$  or  $V_{IN} = V_{OUT(NOM)} + 0.4\text{ V}$  (whichever is greater),  $V_{BIAS} = \text{open}$ ,  $V_{OUT(NOM)} = 0.8\text{ V}$ ,  $V_{EN} = 1.1\text{ V}$ ,  $C_{OUT} = 47\text{ }\mu\text{F}$ ,  $C_{NR/SS} = 0\text{ nF}$ ,  $C_{FF} = 0\text{ nF}$ , and PG pin pulled up to  $V_{IN}$  with  $100\text{ k}\Omega$  (unless otherwise noted)

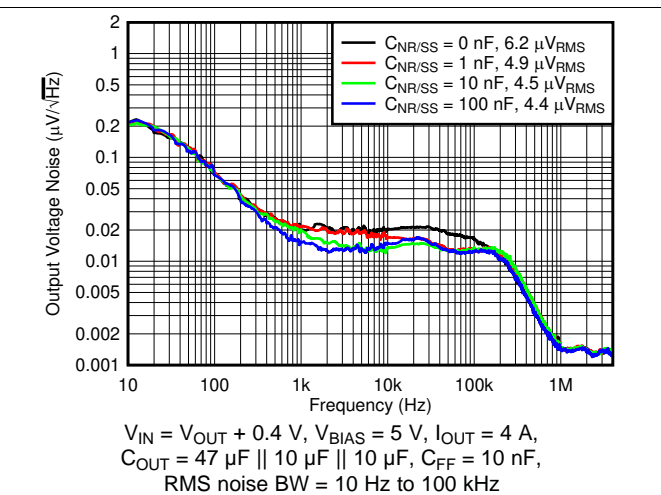
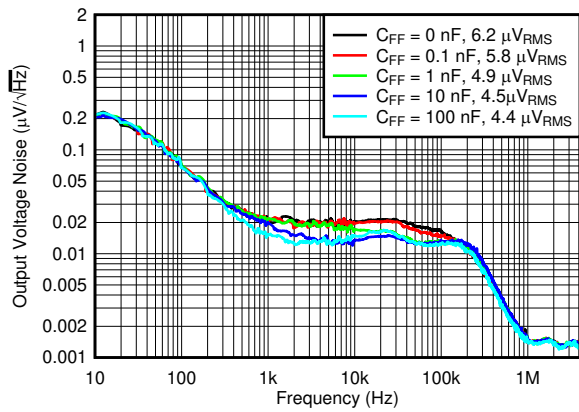

$V_{IN} = V_{OUT} + 0.4\text{ V}$ ,  $V_{BIAS} = 5\text{ V}$ ,  $I_{OUT} = 4\text{ A}$ , sequencing with a DC/DC converter and PG,  $C_{OUT} = 47\text{ }\mu\text{F} \parallel 10\text{ }\mu\text{F} \parallel 10\text{ }\mu\text{F}$ ,  $C_{NR/SS} = 10\text{ nF}$ , RMS noise BW = 10 Hz to 100 kHz

图 13. Output Voltage Noise vs Frequency and  $C_{FF}$

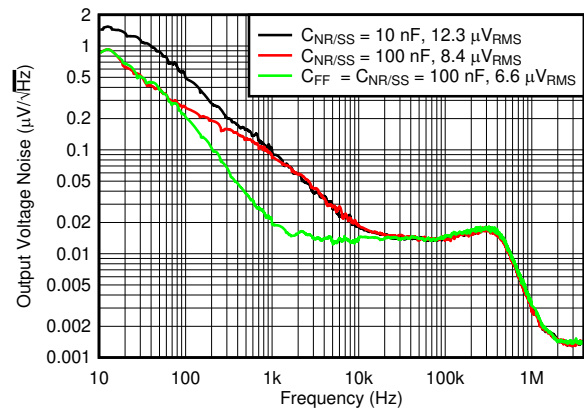

$V_{IN} = 5.6\text{ V}$ ,  $I_{OUT} = 4\text{ A}$ ,  $C_{OUT} = 47\text{ }\mu\text{F} \parallel 10\text{ }\mu\text{F} \parallel 10\text{ }\mu\text{F}$ ,  $C_{FF} = 10\text{ nF}$ , RMS noise BW = 10 Hz to 100 kHz

图 14. Output Voltage Noise vs Frequency at 5.0-V Output

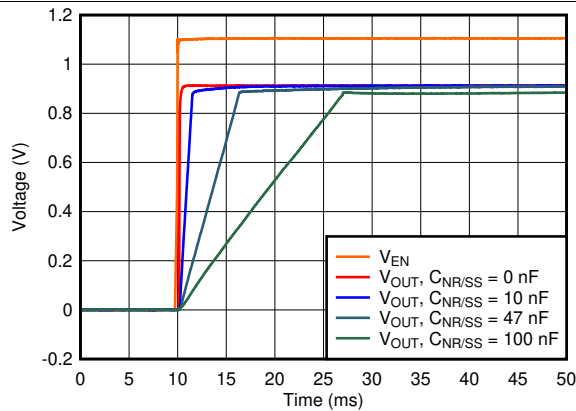

$V_{IN} = 1.2\text{ V}$ ,  $V_{OUT} = 0.9\text{ V}$ ,  $V_{BIAS} = 5.0\text{ V}$ ,  $I_{OUT} = 4\text{ A}$ ,  $C_{OUT} = 47\text{ }\mu\text{F} \parallel 10\text{ }\mu\text{F} \parallel 10\text{ }\mu\text{F}$ ,  $C_{FF} = 10\text{ nF}$

图 15. Start-Up Waveform vs Time and  $C_{NR/SS}$

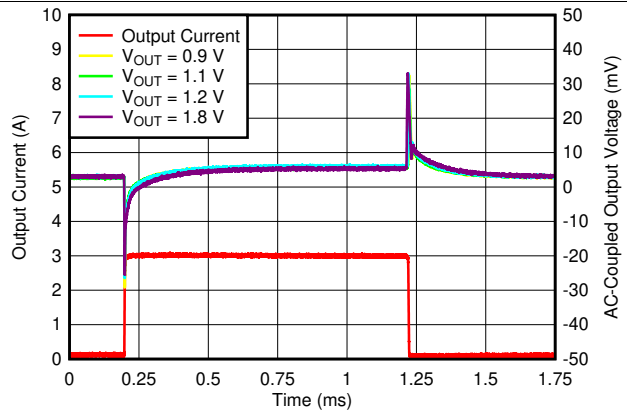

$V_{IN} = V_{OUT} + 0.3\text{ V}$ ,  $V_{BIAS} = 5\text{ V}$ ,  $I_{OUT, DC} = 100\text{ mA}$ , slew rate =  $1\text{ A}/\mu\text{s}$ ,  $C_{NR/SS} = C_{FF} = 10\text{ nF}$ ,  $C_{OUT} = 47\text{ }\mu\text{F} \parallel 10\text{ }\mu\text{F} \parallel 10\text{ }\mu\text{F}$

图 16. Load Transient vs Time and  $V_{OUT}$  With Bias

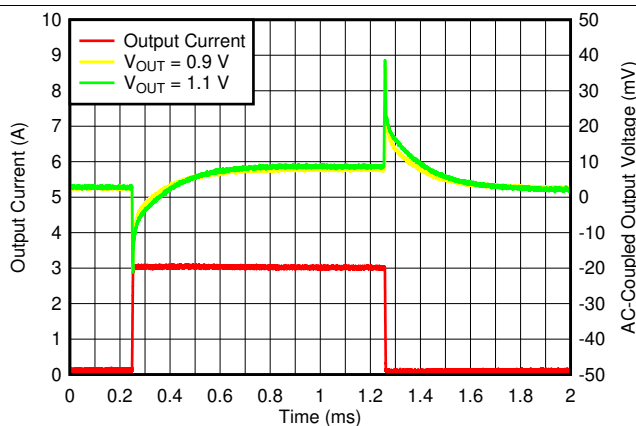

$I_{OUT, DC} = 100\text{ mA}$ ,  $C_{OUT} = 47\text{ }\mu\text{F} \parallel 10\text{ }\mu\text{F} \parallel 10\text{ }\mu\text{F}$ ,  $C_{NR/SS} = C_{FF} = 10\text{ nF}$ , slew rate =  $1\text{ A}/\mu\text{s}$

图 17. Load Transient vs Time and  $V_{OUT}$  Without Bias

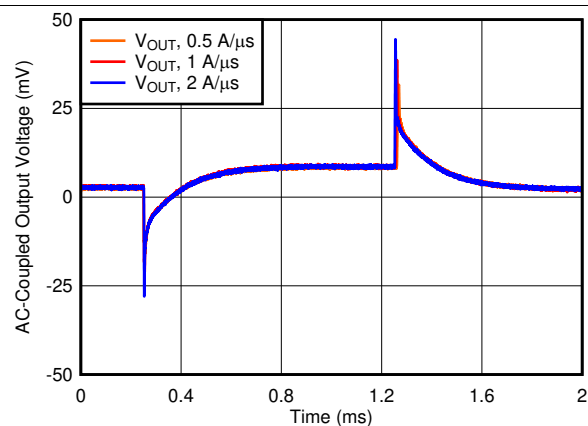

$V_{OUT} = 5\text{ V}$ ,  $I_{OUT, DC} = 100\text{ mA}$ ,  $I_{OUT} = 100\text{ mA}$  to  $4\text{ A}$ ,  $C_{OUT} = 47\text{ }\mu\text{F} \parallel 10\text{ }\mu\text{F} \parallel 10\text{ }\mu\text{F}$ ,  $C_{NR/SS} = C_{FF} = 10\text{ nF}$

图 18. Load Transient vs Time and Slew Rate

Typical Characteristics (接下页)

at  $T_A = 25^\circ\text{C}$ ,  $V_{IN} = 1.4\text{ V}$  or  $V_{IN} = V_{OUT(NOM)} + 0.4\text{ V}$  (whichever is greater),  $V_{BIAS} = \text{open}$ ,  $V_{OUT(NOM)} = 0.8\text{ V}$ ,  $V_{EN} = 1.1\text{ V}$ ,  $C_{OUT} = 47\text{ }\mu\text{F}$ ,  $C_{NR/SS} = 0\text{ nF}$ ,  $C_{FF} = 0\text{ nF}$ , and PG pin pulled up to  $V_{IN}$  with  $100\text{ k}\Omega$  (unless otherwise noted)

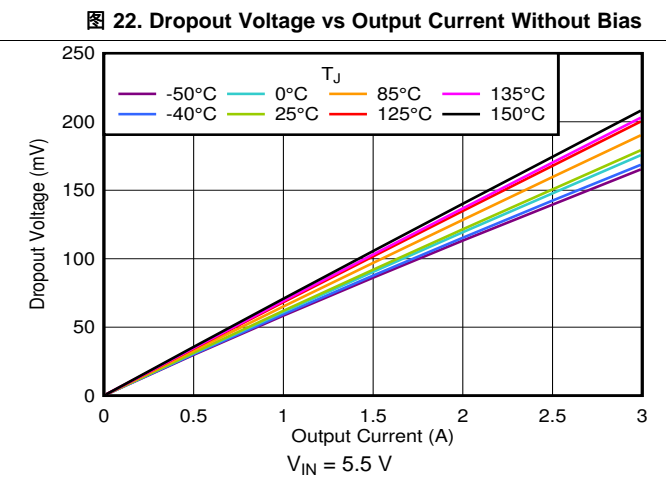
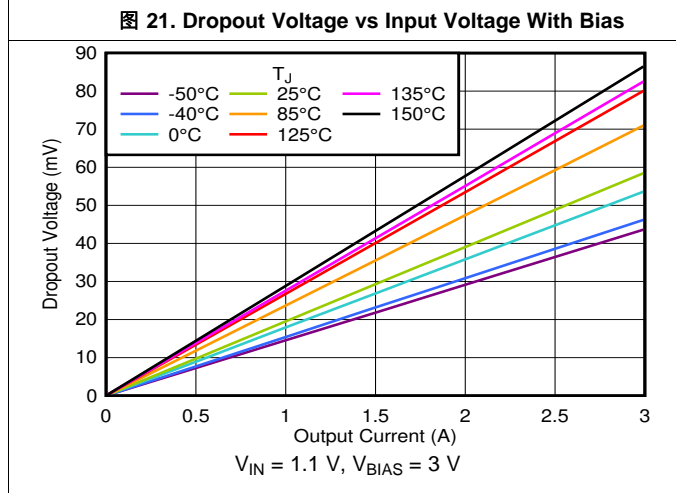
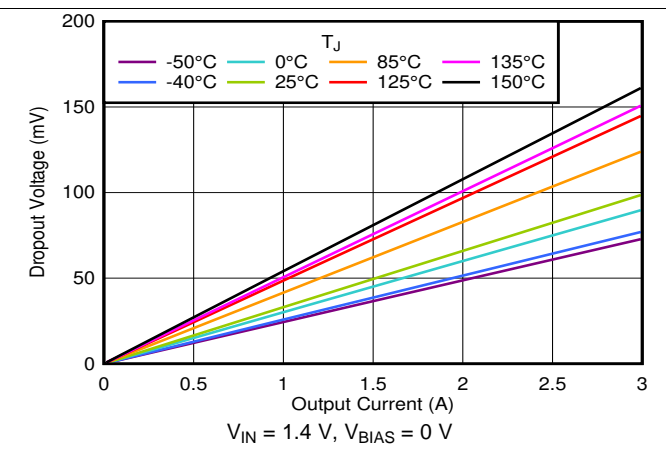
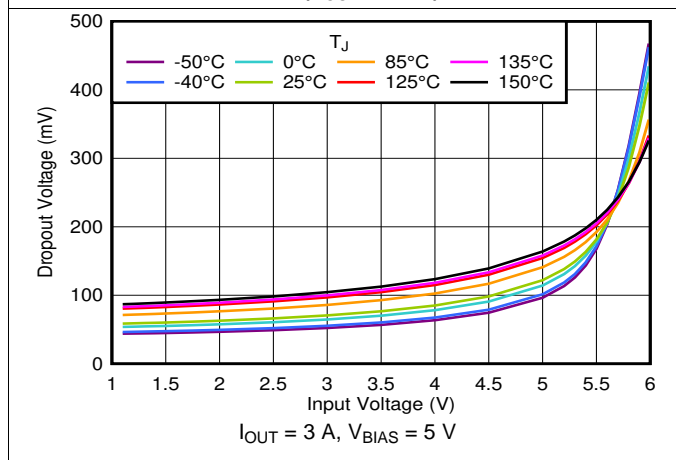
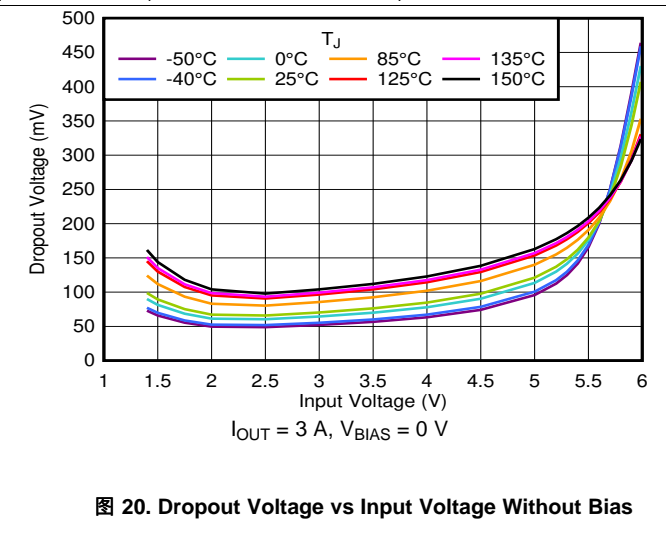
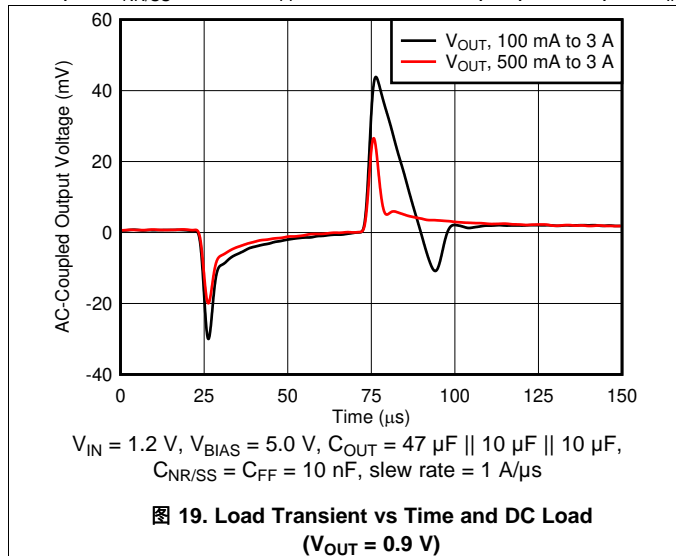

Typical Characteristics (接下页)

at  $T_A = 25^\circ\text{C}$ ,  $V_{IN} = 1.4\text{ V}$  or  $V_{IN} = V_{OUT(NOM)} + 0.4\text{ V}$  (whichever is greater),  $V_{BIAS} = \text{open}$ ,  $V_{OUT(NOM)} = 0.8\text{ V}$ ,  $V_{EN} = 1.1\text{ V}$ ,  $C_{OUT} = 47\text{ }\mu\text{F}$ ,  $C_{NR/SS} = 0\text{ nF}$ ,  $C_{FF} = 0\text{ nF}$ , and PG pin pulled up to  $V_{IN}$  with  $100\text{ k}\Omega$  (unless otherwise noted)

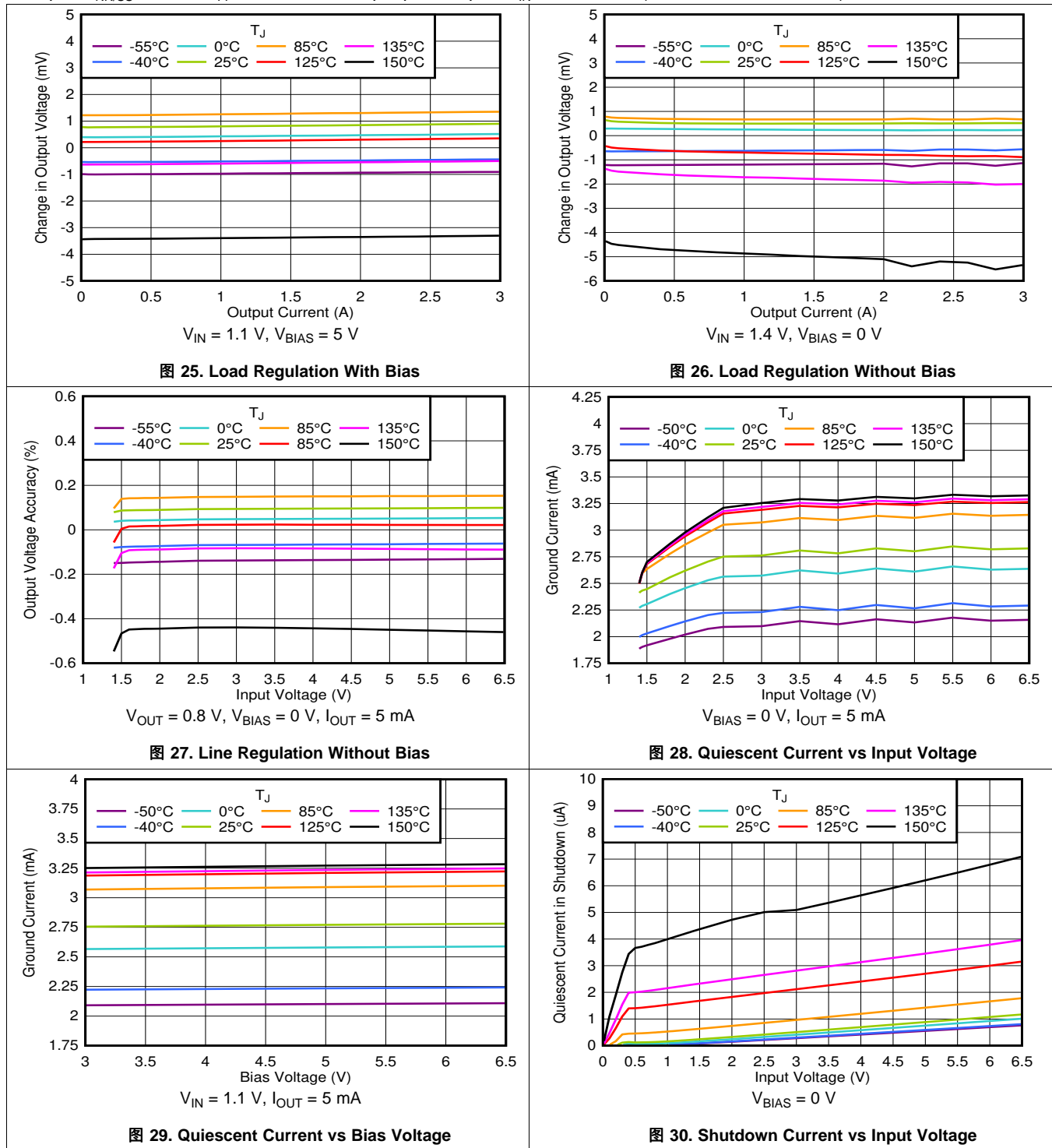

Typical Characteristics (接下页)

at  $T_A = 25^\circ\text{C}$ ,  $V_{IN} = 1.4\text{ V}$  or  $V_{IN} = V_{OUT(NOM)} + 0.4\text{ V}$  (whichever is greater),  $V_{BIAS} = \text{open}$ ,  $V_{OUT(NOM)} = 0.8\text{ V}$ ,  $V_{EN} = 1.1\text{ V}$ ,  $C_{OUT} = 47\text{ }\mu\text{F}$ ,  $C_{NR/SS} = 0\text{ nF}$ ,  $C_{FF} = 0\text{ nF}$ , and PG pin pulled up to  $V_{IN}$  with  $100\text{ k}\Omega$  (unless otherwise noted)



图 31. Shutdown Current vs Bias Voltage



图 32. NR/SS Current vs Input Voltage

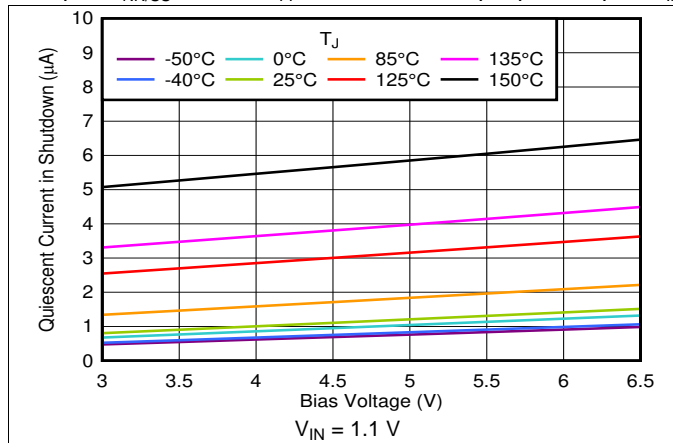

图 33.  $V_{IN}$  UVLO vs Temperature

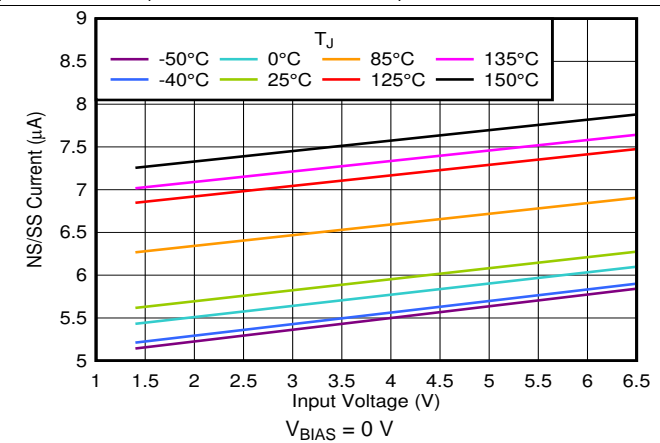

图 34.  $V_{BIAS}$  UVLO vs Temperature

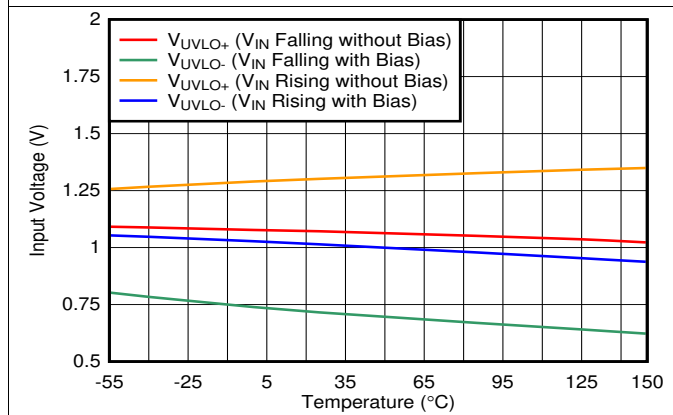

图 35. Enable Threshold vs Temperature

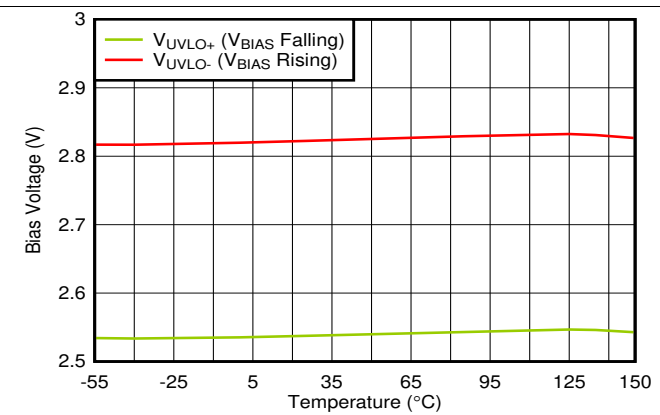

图 36. PG Voltage vs PG Current Sink

Typical Characteristics (接下页)

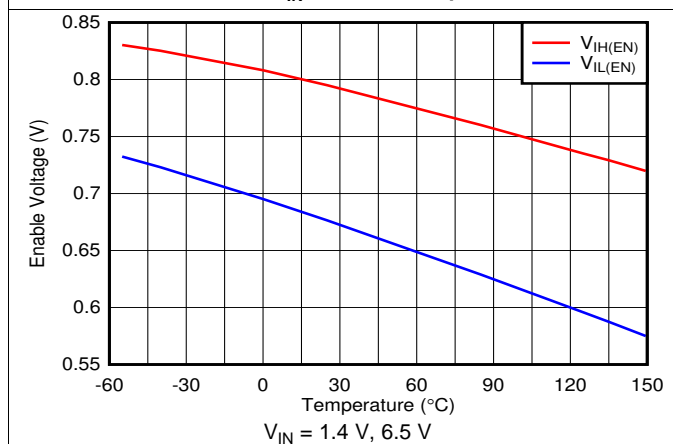
at  $T_A = 25^\circ\text{C}$ ,  $V_{IN} = 1.4\text{ V}$  or  $V_{IN} = V_{OUT(NOM)} + 0.4\text{ V}$  (whichever is greater),  $V_{BIAS} = \text{open}$ ,  $V_{OUT(NOM)} = 0.8\text{ V}$ ,  $V_{EN} = 1.1\text{ V}$ ,  $C_{OUT} = 47\text{ }\mu\text{F}$ ,  $C_{NR/SS} = 0\text{ nF}$ ,  $C_{FF} = 0\text{ nF}$ , and PG pin pulled up to  $V_{IN}$  with  $100\text{ k}\Omega$  (unless otherwise noted)

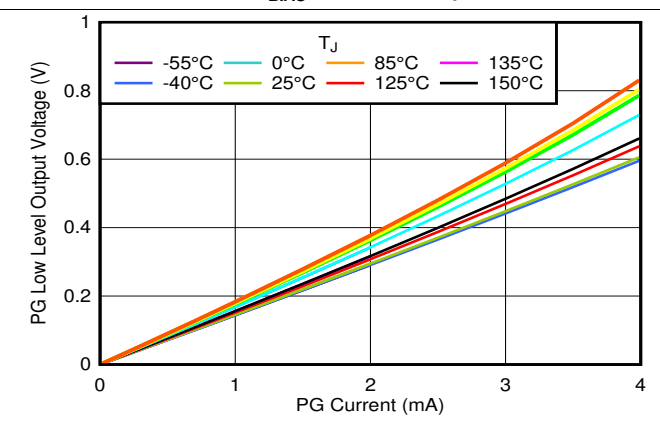

图 37. PG Voltage vs PG Current Sink



图 38. PG Threshold vs Temperature

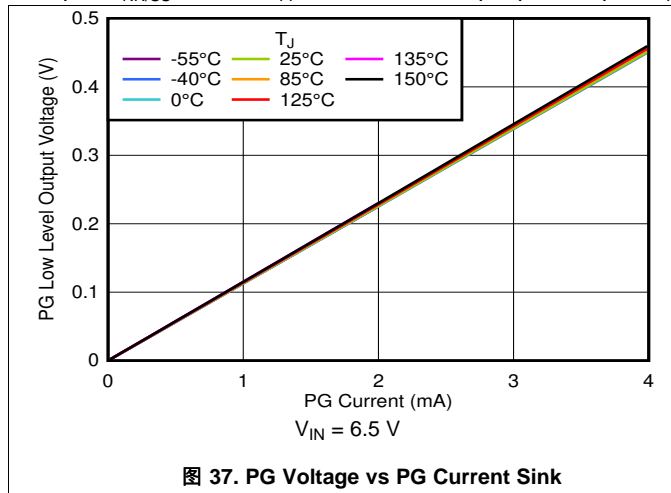

图 39. Foldback Current Limit vs Temperature

## 7 Detailed Description

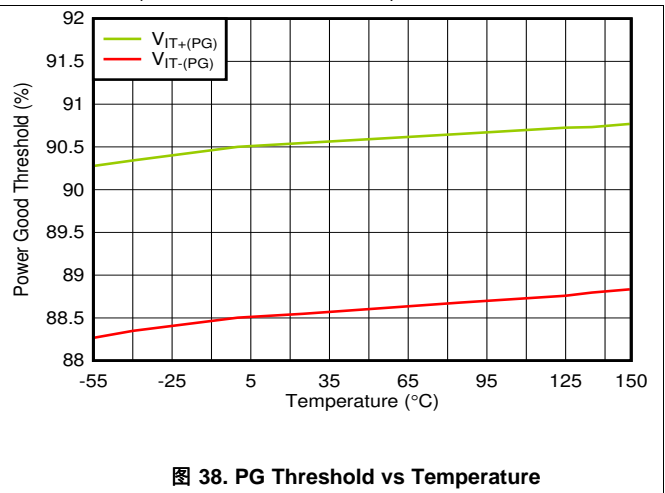
### 7.1 Overview

The TPS7A52 is a high-current (4 A), low-noise ( $4.4 \mu\text{V}_{\text{RMS}}$ ), high accuracy (1%) low-dropout linear voltage regulator with an input range of 1.1 V to 6.5 V and an output voltage range of 0.8 V to 5.1 V. The TPS7A52 has an integrated charge pump for ease of use, and an external bias rail to allow for the lowest dropout across the entire output voltage range. 表 1 categorizes the functions shown in the *Functional Block Diagram*. These features make the TPS7A52 a robust solution to solve many challenging problems by generating a clean, accurate power supply in a variety of applications.

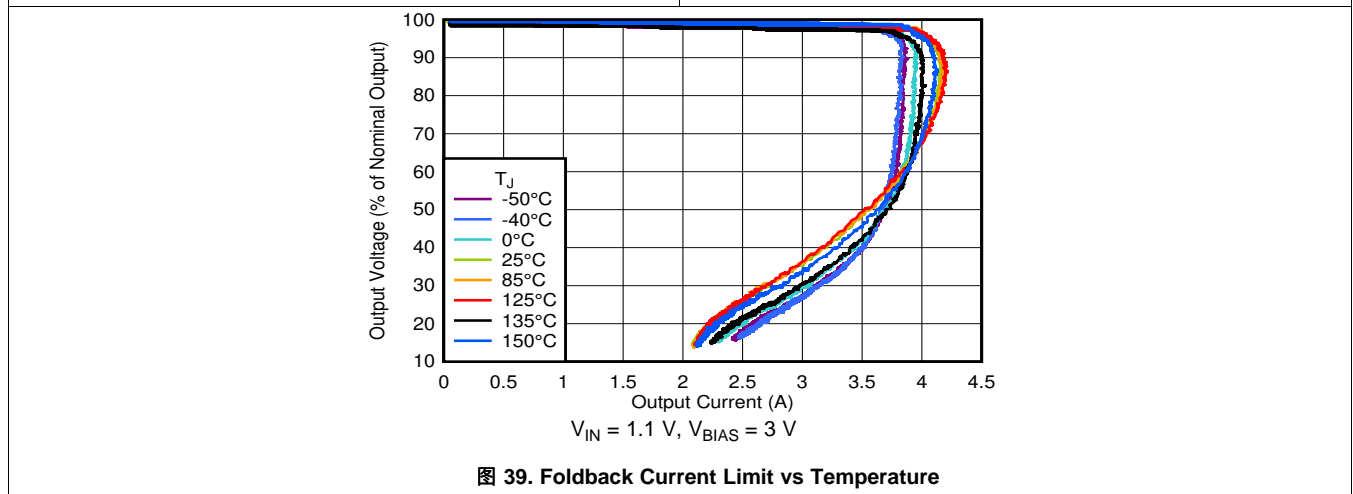
表 1. Device Features

VOLTAGE REGULATION	SYSTEM START-UP	INTERNAL PROTECTION
High accuracy	Programmable soft start	Foldback current limit
Low-noise, high-PSRR output	No sequencing requirement between BIAS, IN, and EN	Thermal shutdown
Fast transient response	Power-good output	
	Start-up with negative bias on OUT	

### 7.2 Functional Block Diagram

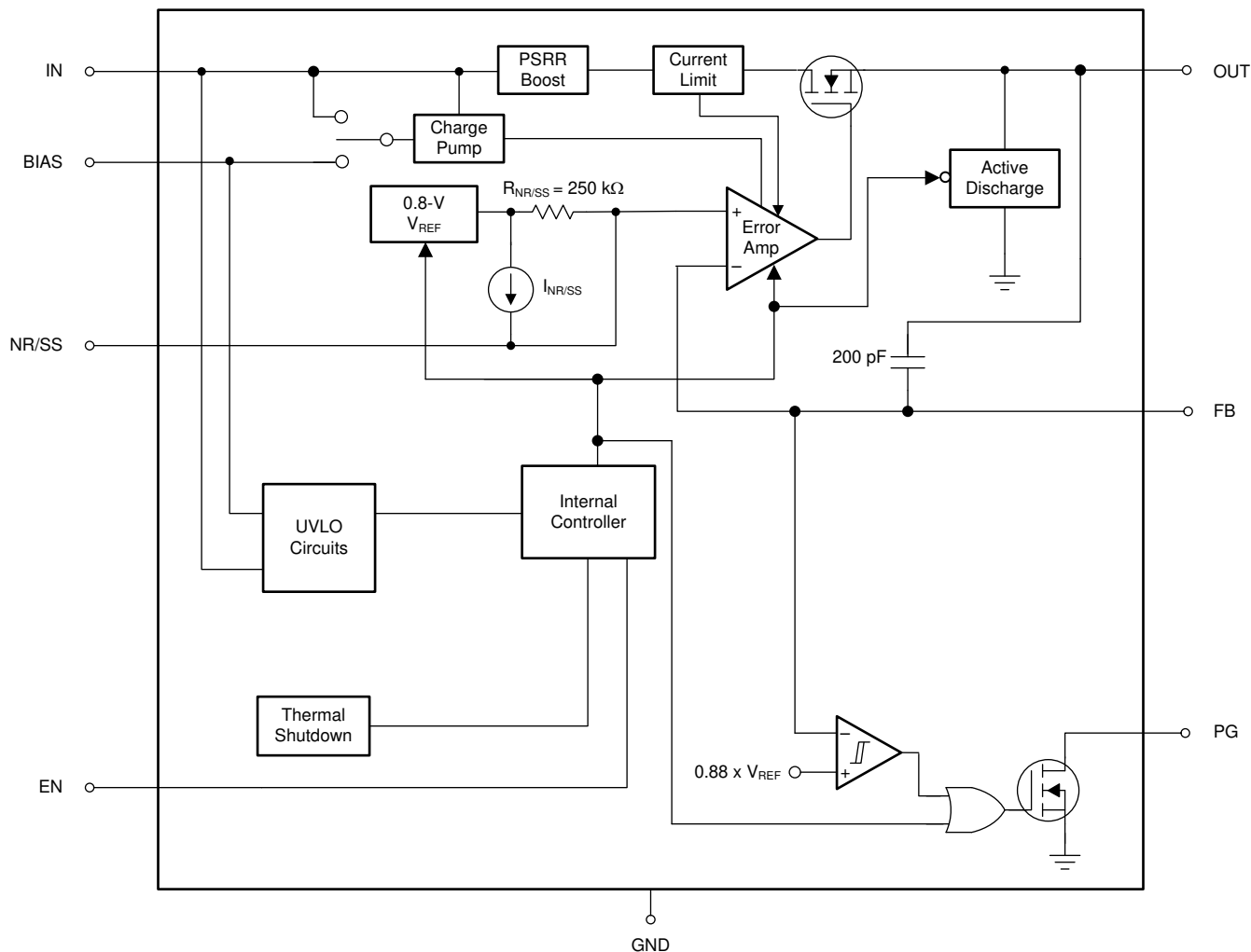

## 7.3 Feature Description

### 7.3.1 Voltage Regulation Features

#### 7.3.1.1 DC Regulation

A low dropout regulator (LDO) functions as a class-B amplifier, as shown in 图 40, in which the input signal is the internal reference voltage ( $V_{REF}$ ).  $V_{REF}$  is designed to have very low bandwidth at the input to the error amplifier through the use of a low-pass filter ( $V_{NR/SS}$ ).

As such, the reference can be considered as a pure dc input signal. The low output impedance of an LDO comes from the combination of the output capacitor and pass element. The pass element also presents a high input impedance to the source voltage when operating as a current source. A positive LDO can only source current because of the class-B architecture.

This device achieves a maximum of 1% output voltage accuracy primarily because of the high-precision band-gap voltage ( $V_{BG}$ ) that creates  $V_{REF}$ . The low dropout voltage ( $V_{DO}$ ) reduces the thermal power dissipation required by the device to regulate the output voltage at a given current level, thereby improving system efficiency. These features combine to make this device a good approximation of an ideal voltage source.

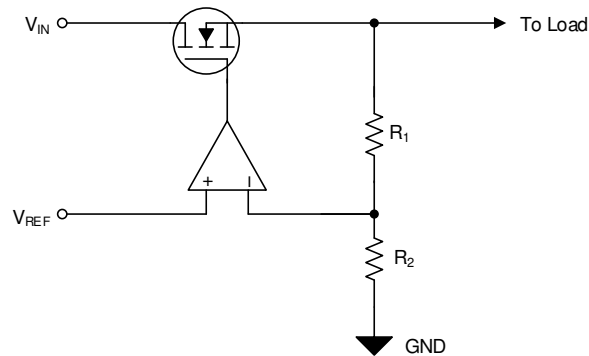

NOTE:  $V_{OUT} = V_{REF} \times (1 + R_1 / R_2)$ .

图 40. Simplified Regulation Circuit

#### 7.3.1.2 AC and Transient Response

The LDO responds quickly to a transient (large-signal response) on the input supply (line transient) or the output current (load transient) resulting from the LDO high-input impedance and low output-impedance across frequency. This same capability also means that the LDO has a high power-supply rejection ratio (PSRR) and, when coupled with a low internal noise-floor ( $V_n$ ), the LDO approximates an ideal power supply in ac (small-signal) and large-signal conditions.

The choice of external component values optimizes the small- and large-signal response. The NR/SS capacitor ( $C_{NR/SS}$ ) and feed-forward capacitor ( $C_{FF}$ ) easily reduce the device noise floor and improve PSRR.



## Feature Description (接下页)

### 7.3.2 System Start-Up Features

In many different applications, the power-supply output must turn on within a specific window of time to either provide proper operation of the load or to minimize the loading on the input supply or other sequencing requirements. The LDO start-up is well-controlled and user-adjustable, solving the demanding requirements faced by many power-supply design engineers in a simple fashion.

#### 7.3.2.1 Programmable Soft Start (NR/SS Pin)

Soft start directly controls the output start-up time and indirectly controls the output current during start-up (inrush current).

As shown in 图 41, the external capacitor at the NR/SS pin ( $C_{NR/SS}$ ) sets the output start-up time by setting the rise time of the internal reference ( $V_{NR/SS}$ ).



图 41. Simplified Soft-Start Circuit

#### 7.3.2.2 Internal Sequencing

Controlling when a single power supply turns on can be difficult in a power distribution network (PDN) because of the high power levels inherent in a PDN, and the variations between all of the supplies. As shown in 图 42 and 表 2, the LDO turnon and turnoff time is set by the enable circuit (EN) and undervoltage lockout circuits ( $UVLO_{1,2(IN)}$  and  $UVLO_{BIAS}$ ).

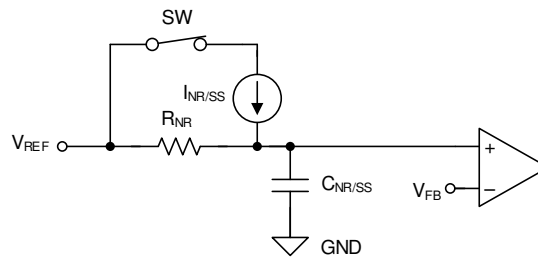

图 42. Simplified Turnon Control

表 2. Internal Sequencing Functionality Table

INPUT VOLTAGE	BIAS VOLTAGE	ENABLE STATUS	LDO STATUS	ACTIVE DISCHARGE	POWER GOOD
$V_{IN} \geq V_{UVLO_{1,2(IN)}}$	$V_{BIAS} \geq V_{UVLO(BIAS)}$	EN = 1	On	Off	PG = 1 when $V_{OUT} \geq V_{IT(PG)}$
		EN = 0	Off	On	
$V_{IN} < V_{UVLO_{1,2(IN)}} - V_{HYS1,2(IN)}$	BIAS = don't care	EN = don't care	Off	On <sup>(1)</sup>	PG = 0
			Off		
IN = don't care	$V_{BIAS} \geq V_{UVLO(BIAS)}$		Off		

(1) The active discharge remains on as long as  $V_{IN}$  or  $V_{BIAS}$  provide enough headroom for the discharge circuit to function.

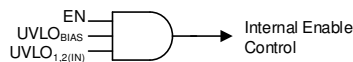
### 7.3.2.2.1 Enable (EN)

The enable signal ( $V_{EN}$ ) is an active-high digital control that enables the LDO when the enable voltage is past the rising threshold ( $V_{EN} \geq V_{IH(EN)}$ ) and disables the LDO when the enable voltage is below the falling threshold ( $V_{EN} \leq V_{IL(EN)}$ ). The exact enable threshold is between  $V_{IH(EN)}$  and  $V_{IL(EN)}$  because EN is a digital control. Connect EN to  $V_{IN}$  if enable functionality is not desired.

### 7.3.2.2.2 Undervoltage Lockout (UVLO) Control

The UVLO circuits respond quickly to glitches on IN or BIAS and attempts to disable the output of the device if either of these rails collapse.

### 7.3.2.2.3 Active Discharge

When either EN or UVLO are low, the device connects a resistor of several hundred ohms from  $V_{OUT}$  to GND, discharging the output capacitance.

Do not rely on the active discharge circuit for discharging large output capacitors when the input voltage drops below the targeted output voltage. Current flows from the output to the input (reverse current) when  $V_{OUT} > V_{IN}$ , which can cause damage to the device (when  $V_{OUT} > V_{IN} + 0.3\text{ V}$ ).

### 7.3.2.3 Power-Good Output (PG)

The PG signal provides an easy solution to meet demanding sequencing requirements because PG signals when the output nears its nominal value. PG can be used to signal other devices in a system when the output voltage is near, at, or above the set output voltage ( $V_{OUT(nom)}$ ). [Figure 43](#) shows a simplified schematic.

The PG signal is an open-drain digital output that requires a pullup resistor to a voltage source and is active high. The PG circuit sets the PG pin into a high-impedance state to indicate that the power is good.

Using a large feed-forward capacitor ( $C_{FF}$ ) delays the output voltage and, because the PG circuit monitors the FB pin, the PG signal can indicate a false positive.

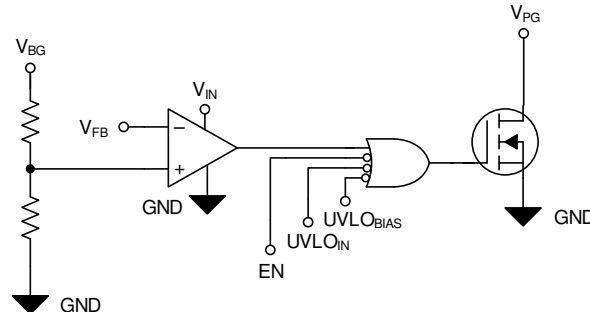

**图 43. Simplified PG Circuit**

## 7.3.3 Internal Protection Features

In many applications, fault events can occur that damage devices in the system. Short circuits and excessive heat are the most common fault events for power supplies. The TPS7A52 implements circuitry to protect the device and its load during these events. Continuously operating in these fault conditions or above a junction temperature of  $140^{\circ}\text{C}$  is not recommended because the long-term reliability of the device is reduced.

### 7.3.3.1 Foldback Current Limit ( $I_{CL}$ )

The internal current limit circuit is used to protect the LDO against high load-current faults or shorting events. During a current-limit event, the LDO sources constant current; therefore, the output voltage falls with decreased load impedance. Thermal shutdown can activate during a current limit event because of the high power dissipation typically found in these conditions. For proper operation of the current limit, minimize the inductances to the input and load. Continuous operation in current limit is not recommended.

### 7.3.3.2 Thermal Protection ( $T_{sd}$ )

The thermal shutdown circuit protects the LDO against excessive heat in the system, either resulting from current limit or high ambient temperature.

The output of the LDO turns off when the LDO temperature (junction temperature,  $T_J$ ) exceeds the rising thermal shutdown temperature. The output turns on again after  $T_J$  decreases below the falling thermal shutdown temperature.

A high power dissipation across the device, combined with a high ambient temperature ( $T_A$ ), can cause  $T_J$  to be greater than or equal to  $T_{sd}$ , triggering the thermal shutdown and causing the output to fall to 0 V. The LDO can cycle on and off when thermal shutdown is reached under these conditions.

## 7.4 Device Functional Modes

表 3 provides a quick comparison between the regulation and disabled operation.

**表 3. Device Functional Modes Comparison**

OPERATING MODE	PARAMETER				
	$V_{IN}$	$V_{BIAS}$	EN	$I_{OUT}$	$T_J$
Regulation <sup>(1)</sup>	$V_{IN} > V_{OUT(nom)} + V_{DO}$	$V_{BIAS} \geq V_{UVLO(BIAS)}$ <sup>(2)</sup>	$V_{EN} > V_{IH(EN)}$	$I_{OUT} < I_{CL}$	$T_J \leq T_{J(maximum)}$
Disabled <sup>(3)</sup>	$V_{IN} < V_{UVLO\_1,2(IN)}$	$V_{BIAS} < V_{UVLO(BIAS)}$	$V_{EN} < V_{IL(EN)}$	—	$T_J > T_{sd}$

(1) All table conditions must be met.

(2)  $V_{BIAS}$  is only required for  $V_{IN} < 1.4$  V.

(3) The device is disabled when any condition is met.

### 7.4.1 Regulation

The device regulates the output to the nominal output voltage when all conditions in 表 3 are met.

### 7.4.2 Disabled

When disabled, the pass device is turned off, the internal circuits are shut down, and the output voltage is actively discharged to ground by an internal resistor from the output to ground. See the [Active Discharge](#) section for additional information.

### 7.4.3 Current Limit Operation

During a current-limit event, the LDO regulates the output current instead of the output voltage; therefore, the output voltage falls with decreased load impedance..

## 8 Application and Implementation

### 注

Information in the following applications sections is not part of the TI component specification, and TI does not warrant its accuracy or completeness. TI's customers are responsible for determining suitability of components for their purposes. Customers should validate and test their design implementation to confirm system functionality.

### 8.1 Application Information

Successfully implementing an LDO in an application depends on the application requirements. This section discusses key device features and how to best implement them to achieve a reliable design.

#### 8.1.1 Recommended Capacitor Types

The TPS7A52 is designed to be stable using low equivalent series resistance (ESR) ceramic capacitors at the input, output, and noise-reduction pin (NR, pin 13). Multilayer ceramic capacitors have become the industry standard for these types of applications and are recommended, but must be used with good judgment. Ceramic capacitors that employ X7R-, X5R-, and COG-rated dielectric materials provide relatively good capacitive stability across temperature. The use of Y5V-rated capacitors is discouraged because of large variations in capacitance.

Regardless of the ceramic capacitor type selected, ceramic capacitance varies with operating voltage and temperature. Make sure to derate ceramic capacitors by at least 50%. The input and output capacitors recommended herein account for a capacitance derating of approximately 50%, but at high  $V_{IN}$  and  $V_{OUT}$  conditions ( $V_{IN} = 5.5\text{ V}$  to  $V_{OUT} = 5.0\text{ V}$ ), the derating can be greater than 50%, and must be taken into consideration.

##### 8.1.1.1 Input and Output Capacitor Requirements ( $C_{IN}$ and $C_{OUT}$ )

The TPS7A52 is designed and characterized for operation with ceramic capacitors of 47  $\mu\text{F}$  or greater (22  $\mu\text{F}$  or greater of capacitance) at the output and 10  $\mu\text{F}$  or greater (5  $\mu\text{F}$  or greater of capacitance) at the input. Use at least a 47- $\mu\text{F}$  capacitor at the input to minimize input impedance. Place the input and output capacitors as near as practical to the respective input and output pins in order to minimize trace parasitics. If the trace inductance from the input supply to the TPS7A52 is high, a fast current transient can cause  $V_{IN}$  to ring above the absolute maximum voltage rating and damage the device. This situation can be mitigated by additional input capacitors to dampen and keep the ringing below the device absolute maximum ratings.

A combination of multiple output capacitors boosts the high-frequency PSRR. The combination of one 0805-sized, 47- $\mu\text{F}$  ceramic capacitor in parallel with two 0805-sized, 10- $\mu\text{F}$  ceramic capacitors with a sufficient voltage rating, in conjunction with the PSRR boost circuit, optimizes PSRR for the frequency range of 400 kHz to 700 kHz, a typical range for dc/dc supply switching frequency. This 47- $\mu\text{F}$  || 10- $\mu\text{F}$  || 10- $\mu\text{F}$  capacitor combination also makes certain that at high input voltage and high output voltage configurations, the minimum effective capacitance is met. Many 0805-sized, 47- $\mu\text{F}$  ceramic capacitors have a voltage derating of approximately 60% to 80% at 5.0 V, so the addition of the two 10- $\mu\text{F}$  capacitors makes sure that the capacitance is at or above 22  $\mu\text{F}$ .

## Application Information (接下页)

### 8.1.1.2 Noise-Reduction and Soft-Start Capacitor ( $C_{NR/SS}$ )

The TPS7A52 features a programmable, monotonic, voltage-controlled soft start that is set with an external capacitor ( $C_{NR/SS}$ ). Use an external  $C_{NR/SS}$  to minimize inrush current into the output capacitors. This soft-start feature eliminates power-up initialization problems when powering field-programmable gate arrays (FPGAs), digital signal processors (DSPs), or other processors. The controlled voltage ramp of the output also reduces peak inrush current during start-up, minimizing start-up transients to the input power bus.

To achieve a monotonic start-up, the TPS7A52 error amplifier tracks the voltage ramp of the external soft-start capacitor until the voltage approaches the internal reference. The soft-start ramp time depends on the soft-start charging current ( $I_{NR/SS}$ ), the soft-start capacitance ( $C_{NR/SS}$ ), and the internal reference ( $V_{NR/SS}$ ). Use [公式 1](#) to calculate the soft-start ramp time:

$$t_{SS} = (V_{NR/SS} \times C_{NR/SS}) / I_{NR/SS} \quad (1)$$

$I_{NR/SS}$  is provided in the [Electrical Characteristics](#) table and has a typical value of 6.2  $\mu$ A.

The noise-reduction capacitor, in conjunction with the noise-reduction resistor, forms a low-pass filter (LPF) that filters out the noise from the reference before being gained up with the error amplifier, thereby reducing the device noise floor. The LPF is a single-pole filter and [公式 2](#) can calculate the cutoff frequency. The typical value of  $R_{NR}$  is 250 k $\Omega$ . Increasing the  $C_{NR/SS}$  capacitor has a greater affect because the output voltage increases when the noise from the reference is gained up even more at higher output voltages. For low-noise applications, a 10-nF to 1- $\mu$ F  $C_{NR/SS}$  is recommended.

$$f_{cutoff} = 1 / (2 \times \pi \times R_{NR} \times C_{NR/SS}) \quad (2)$$

### 8.1.1.3 Feed-Forward Capacitor ( $C_{FF}$ )

Although a feed-forward capacitor ( $C_{FF}$ ) from the FB pin to the OUT pin is not required to achieve stability, a 10-nF external feed-forward capacitor optimizes the transient, noise, and PSRR performance. A higher capacitance  $C_{FF}$  can be used; however, the start-up time is longer and the power-good signal can incorrectly indicate that the output voltage is settled. For a detailed description, see the [Pros and Cons of Using a Feed-Forward Capacitor with a Low Dropout Regulator](#) application report.

## 8.1.2 Soft Start and Inrush Current

Soft start refers to the ramp-up characteristic of the output voltage during LDO turnon after EN and UVLO achieve threshold voltage. The noise-reduction capacitor serves a dual purpose of both governing output noise reduction and programming the soft-start ramp during turnon.

Inrush current is defined as the current into the LDO at the IN pin during start-up. Inrush current then consists primarily of the sum of load current and the current used to charge the output capacitor. This current is difficult to measure because the input capacitor must be removed, which is not recommended. However, [公式 3](#) can estimate this soft-start current:

$$I_{OUT(t)} = \left[ \frac{C_{OUT} \times dV_{OUT}(t)}{dt} \right] + \left[ \frac{V_{OUT}(t)}{R_{LOAD}} \right]$$

where:

- $V_{OUT}(t)$  is the instantaneous output voltage of the turnon ramp
- $dV_{OUT}(t) / dt$  is the slope of the  $V_{OUT}$  ramp
- $R_{LOAD}$  is the resistive load impedance

(3)

## Application Information (接下页)

### 8.1.3 Optimizing Noise and PSRR

Improve the ultra-low noise floor and PSRR of the device by careful selection of:

- $C_{NR/SS}$  for the low-frequency range
- $C_{FF}$  in the midband frequency range
- $C_{OUT}$  for the high-frequency range
- $V_{IN} - V_{OUT}$  for all frequencies
- $V_{BIAS}$  at lower input voltages

A larger noise-reduction capacitor improves low-frequency PSRR by filtering any noise coupling from the input into the reference. To improve midband PSRR, use the feed-forward capacitor to place a zero-pole pair near the edge of the loop bandwidth and push out the loop bandwidth. Use larger output capacitors to improve high-frequency PSRR.

A higher input voltage improves PSRR by giving the device more headroom to respond to noise on the input. A bias rail also improves PSRR at lower input voltages because greater headroom is provided for the internal circuits.

The noise-reduction capacitor filters out low-frequency noise from the reference, and the feed-forward capacitor reduces output voltage noise by filtering out midband frequency noise. However, a large feed-forward capacitor can create new issues that are discussed in the [Pros and Cons of Using a Feed-Forward Capacitor with a Low Dropout Regulator application report](#).

Use a large output capacitor to reduce high-frequency output voltage noise. Additionally, a bias rail or higher input voltage improves noise because greater headroom is provided for the internal circuits.

表 4 lists the output voltage noise for the 10-Hz to 100-kHz band at a 5.0-V output for a variety of conditions with an input voltage of 5.5 V, an  $R_1$  of 12.1 k $\Omega$ , and a load current of 4 A. The 5.0-V output is used because this output is the worst-case condition for output voltage noise.

**表 4. Output Noise Voltage at a 5.0-V Output**

OUTPUT VOLTAGE NOISE ( $\mu V_{RMS}$ )	$C_{NR/SS}$ (nF)	$C_{FF}$ (nF)	$C_{OUT}$ ( $\mu F$ )
11.7	10	10	47    10    10
7.7	100	10	47    10    10
6	100	100	47    10    10
7.4	100	10	1000
5.8	100	100	1000

### 8.1.4 Charge Pump Noise

The device internal charge pump generates a minimal amount of noise. Use a bias rail to minimize the internal charge pump noise when the internal voltage is clamped, thereby reducing the overall output noise floor.

The high-frequency components of the output voltage noise density curve are filtered out in most applications by using 10-nF to 100-nF bypass capacitors close to the load. Using a ferrite bead between the LDO output and the load input capacitors forms a pi-filter, further reducing the high-frequency noise contribution.

### 8.1.5 Current Sharing

There are two main current sharing implementations:

1. Through the use of external operational amplifiers. For more details, see the [Current-Sharing Dual LDOs reference guide](#) and [6 A Current-Sharing Dual LDO reference guide](#).
2. Through the use of external ballast resistors. For more details of this implementation, see the [High-Current Low-Noise Parallel LDO reference design](#).

### 8.1.6 Adjustable Operation

As shown in 图 44, the output voltage of the TPS7A52-Q1 is set using external resistors.



图 44. Adjustable Operation

Use 公式 4 to calculate  $R_1$  and  $R_2$ . This resistive network must provide a current equal to or greater than  $5\ \mu\text{A}$  for dc accuracy. To optimize the noise and PSRR, use an  $R_1$  of  $12.1\ \text{k}\Omega$ .

$$V_{\text{OUT}} = V_{\text{NR/SS}} \times (1 + R_1 / R_2) \quad (4)$$

表 5 shows the resistor combinations required to achieve several common rails using standard 1%-tolerance resistors.

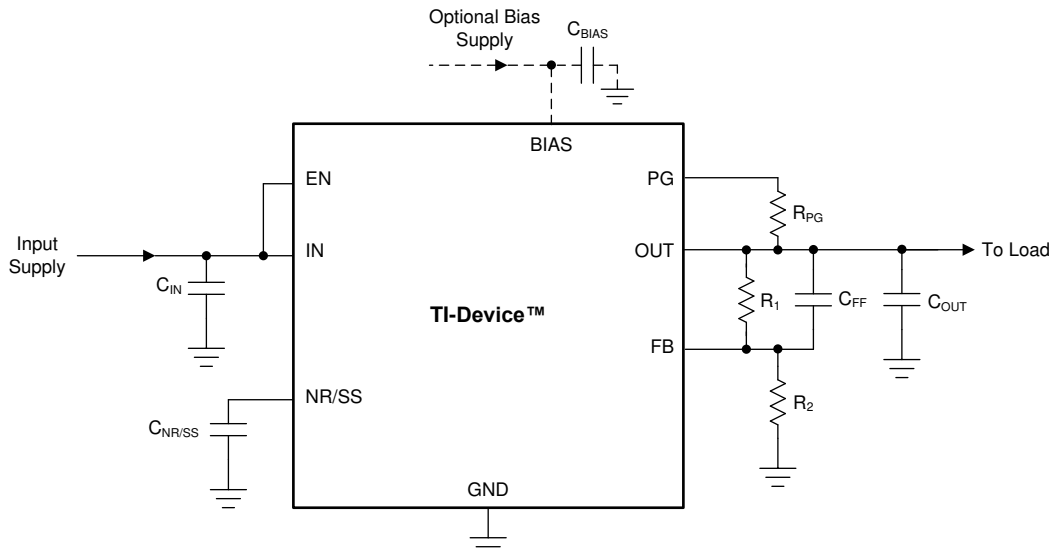
表 5. Recommended Feedback-Resistor Values

TARGETED OUTPUT VOLTAGE (V)	FEEDBACK RESISTOR VALUES <sup>(1)</sup>		CALCULATED OUTPUT VOLTAGE (V)
	$R_1$ (k $\Omega$ )	$R_2$ (k $\Omega$ )	
0.9	12.4	100	0.899
0.95	12.4	66.5	0.949
1.00	12.4	49.9	0.999
1.10	12.4	33.2	1.099
1.20	12.4	24.9	1.198
1.50	12.4	14.3	1.494
1.80	12.4	10	1.798
1.90	12.1	8.87	1.89
2.50	12.4	5.9	2.48
2.85	12.1	4.75	2.838
3.00	12.1	4.42	2.990
3.30	11.8	3.74	3.324
3.60	12.1	3.48	3.582
4.5	11.8	2.55	4.502
5.00	12.4	2.37	4.985

(1)  $R_1$  is connected from OUT to FB;  $R_2$  is connected from FB to GND.

### 8.1.7 Power-Good Operation

For proper operation of the power-good circuit, the pullup resistor value must be between 10 k $\Omega$  and 100 k $\Omega$ . The lower limit of 10 k $\Omega$  results from the maximum pulldown strength of the power-good transistor, and the upper limit of 100 k $\Omega$  results from the maximum leakage current at the power-good node. If the pullup resistor is outside of this range, then the power-good signal may not read a valid digital logic level.

Using a large  $C_{FF}$  with a small  $C_{NR/SS}$  causes the power-good signal to incorrectly indicate that the output voltage has settled during turnon. The  $C_{FF}$  time constant must be greater than the soft-start time constant for proper operation of the PG during start-up. For a detailed description, see the [Pros and Cons of Using a Feed-Forward Capacitor with a Low Dropout Regulator application report](#).

The state of PG is only valid when the device operates above the minimum supply voltage. During short UVLO events and at light loads, power-good does not assert because the output voltage is sustained by the output capacitance.

### 8.1.8 Undervoltage Lockout (UVLO) Operation

The UVLO circuit makes sure that the device remains disabled before the input or bias supplies reach the minimum operational voltage range, and that the device shuts down when the input supply or bias supply falls too low.

The UVLO circuit has a minimum response time of several microseconds to fully assert. During this time, a downward line transient below approximately 0.8 V causes the UVLO to assert for a short time; however, the UVLO circuit does not have enough stored energy to fully discharge the internal circuits inside of the device. When the UVLO circuit does not fully discharge, the internal circuits of the output are not fully disabled.

The effect of the downward line transient can be mitigated by either using a larger input capacitor to limit the fall time of the input supply when operating near the minimum  $V_{IN}$ , or by using a bias rail.

Figure 45 shows the UVLO circuit response to various input voltage events. The diagram can be separated into the following regions:

- Region A: The device does not turn on until the input reaches the UVLO rising threshold.
- Region B: Normal operation with a regulated output.
- Region C: Brownout event above the UVLO falling threshold (UVLO rising threshold – UVLO hysteresis). The output may fall out of regulation but the device is still enabled.
- Region D: Normal operation with a regulated output.
- Region E: Brownout event below the UVLO falling threshold. The device is disabled in most cases and the output falls because of the load and active discharge circuit. The device is reenabled when the UVLO rising threshold is reached by the input voltage and a normal start-up then follows.
- Region F: Normal operation followed by the input falling to the UVLO falling threshold.
- Region G: The device is disabled when the input voltage falls below the UVLO falling threshold to 0 V. The output falls because of the load and active discharge circuit.



图 45. Typical UVLO Operation



### 8.1.9 Dropout Voltage ( $V_{DO}$ )

Generally speaking, the dropout voltage often refers to the minimum voltage difference between the input and output voltage ( $V_{DO} = V_{IN} - V_{OUT}$ ) that is required for regulation. When  $V_{IN}$  drops below the required  $V_{DO}$  for the given load current, the device functions as a resistive switch and does not regulate output voltage. Dropout voltage is proportional to the output current because the device is operating as a resistive switch.

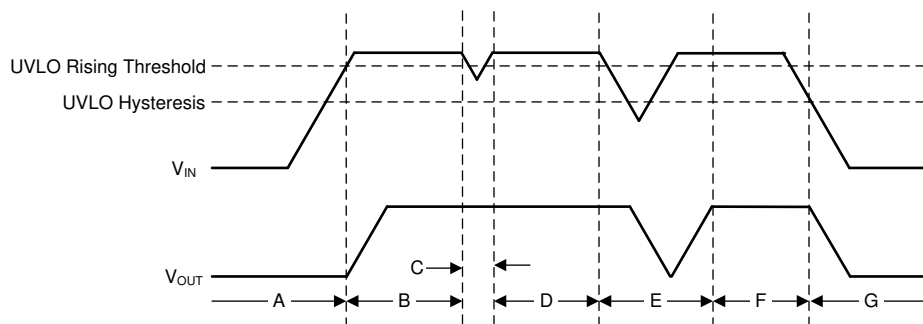
Dropout voltage is affected by the drive strength for the gate of the pass element, which is nonlinear with respect to  $V_{IN}$  on this device because of the internal charge pump. The charge pump causes a higher dropout voltage at lower input voltages when a bias rail is not used.

For this device, dropout voltage increases exponentially when the input voltage nears its maximum operating voltage because the charge pump is internally clamped to 8.0 V.

### 8.1.10 Device Behavior During Transition From Dropout Into Regulation

Some applications have transients that place the device into dropout, especially with a device such as a high-current linear regulator. A typical application with these transient conditions may require setting  $V_{IN} \leq (V_{OUT} + V_{DO})$  in order to keep the device junction temperature within the specified operating range. A load transient or line transient with these conditions can place the device into dropout; for example, a load transient from 1 A to 4 A at 1 A/ $\mu$ s when operating with a  $V_{IN}$  of 5.4 V and a  $V_{OUT}$  of 5.0 V.

The load transient saturates the error amplifier output stage when the gate of the pass element is driven as high as possible by the error amplifier, thus making the pass element function like a resistor from  $V_{IN}$  to  $V_{OUT}$ . The error amplifier response time to this load transient ( $I_{OUT} = 4$  A to 1 A at 1 A/ $\mu$ s) is limited because the error amplifier must first recover from saturation, and then place the pass element back into active mode. During the recovery from the load transient,  $V_{OUT}$  overshoots because the pass element is functioning as a resistor from  $V_{IN}$  to  $V_{OUT}$ . If operating under these conditions, apply a higher dc load or increase the output capacitance in order to reduce the overshoot.

### 8.1.11 Load Transient Response

The load-step transient response is the output voltage response by the LDO to a step in load current, whereby output voltage regulation is maintained. There are two key transitions during a load transient response: the transition from a light to a heavy load, and the transition from a heavy to a light load. The regions shown in [图 46](#) are broken down in this section. Regions A, E, and H are where the output voltage is in steady-state regulation.



图 46. Load Transient Waveform

During transitions from a light load to a heavy load:

- Initial voltage dip is a result of the depletion of the output capacitor charge and parasitic impedance to the output capacitor (region B).
- Recovery from the dip results from the LDO increasing its sourcing current, and leads to output voltage regulation (region C).

During transitions from a heavy load to a light load:

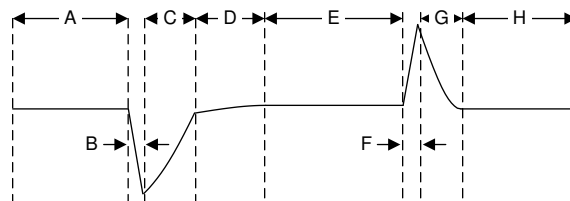
- Initial voltage rise results from the LDO sourcing a large current, and leads to the output capacitor charge to increase (region F).
- Recovery from the rise results from the LDO decreasing its sourcing current in combination with the load discharging the output capacitor (region G).

Transitions between current levels changes the internal power dissipation because the TPS7A52 is a high-current device (region D). The change in power dissipation changes the die temperature during these transitions, and leads to a slightly different voltage level. This different output voltage level shows up in the various load transient responses.

A larger output capacitance reduces the peaks during a load transient but slows down the response time of the device. A larger dc load also reduces the peaks because the amplitude of the transition is lowered and a higher current discharge path is provided for the output capacitor.

### 8.1.12 Reverse Current Protection Considerations

As with most LDOs, this device can be damaged by excessive reverse current.

Conditions where excessive reverse current can occur are outlined in this section, all of which can exceed the absolute maximum rating of  $V_{OUT} > V_{IN} + 0.3\text{ V}$ :

- If the device has a large  $C_{OUT}$ , then the input supply collapses quickly and the load current becomes very small
- The output is biased when the input supply is not established
- The output is biased above the input supply

If an excessive reverse current flow is expected in the application, then external protection must be used to protect the device. [图 47](#) shows one approach of protecting the device.

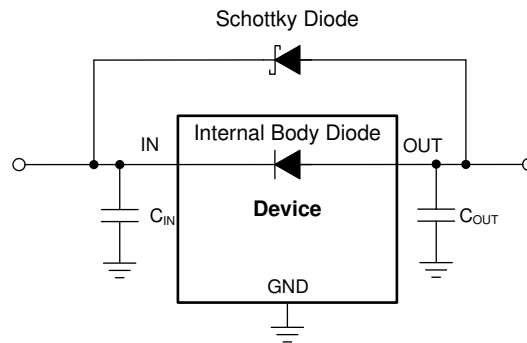

**图 47. Example Circuit for Reverse Current Protection Using a Schottky Diode**

### 8.1.13 Power Dissipation ( $P_D$ )

Circuit reliability demands that proper consideration be given to device power dissipation, location of the circuit on the printed circuit board (PCB), and correct sizing of the thermal plane. The PCB area around the regulator must be as free as possible of other heat-generating devices that cause added thermal stresses.

As a first-order approximation, power dissipation in the regulator depends on the input-to-output voltage difference and load conditions. [公式 5](#) calculates  $P_D$ :

$$P_D = (V_{OUT} - V_{IN}) \times I_{OUT} \quad (5)$$

#### 注

Power dissipation can be minimized, and thus greater efficiency achieved, by proper selection of the system voltage rails. Proper selection allows the minimum input-to-output voltage differential to be obtained. The low dropout of the TPS7A52 allows for maximum efficiency across a wide range of output voltages.

The primary heat conduction path for the package is through the thermal pad to the PCB. Solder the thermal pad to a copper pad area under the device. This pad area contains an array of plated vias that conduct heat to any inner plane areas or to a bottom-side copper plane.

The maximum power dissipation determines the maximum allowable junction temperature ( $T_J$ ) for the device. Power dissipation and junction temperature are most often related by the junction-to-ambient thermal resistance ( $R_{\theta JA}$ ) of the combined PCB and device package and the temperature of the ambient air ( $T_A$ ), according to [公式 6](#). The equation is rearranged for output current in [公式 7](#).

$$T_J = T_A + (R_{\theta JA} \times P_D) \quad (6)$$

$$I_{OUT} = (T_J - T_A) / [R_{\theta JA} \times (V_{IN} - V_{OUT})] \quad (7)$$

Unfortunately, this thermal resistance ( $R_{\theta JA}$ ) is highly dependent on the heat-spreading capability built into the particular PCB design, and therefore varies according to the total copper area, copper weight, and location of the planes. The  $R_{\theta JA}$  recorded in the [Electrical Characteristics](#) table is determined by the JEDEC standard, PCB, and copper-spreading area, and is only used as a relative measure of package thermal performance. For a well-designed thermal layout,  $R_{\theta JA}$  is actually the sum of the VQFN package junction-to-case (bottom) thermal resistance ( $R_{\theta JCbot}$ ) plus the thermal resistance contribution by the PCB copper.

### 8.1.14 Estimating Junction Temperature

The JEDEC standard now recommends the use of psi ( $\Psi$ ) thermal metrics to estimate the junction temperatures of the LDO when in-circuit on a typical PCB board application. These metrics are not strictly speaking thermal resistances, but rather offer practical and relative means of estimating junction temperatures. These psi metrics are determined to be significantly independent of the copper-spreading area. The key thermal metrics ( $\Psi_{JT}$  and  $\Psi_{JB}$ ) are used in accordance with [公式 8](#) and are given in the [Electrical Characteristics](#) table.

$$\Psi_{JT}: T_J = T_T + \Psi_{JT} \times P_D$$

$$\Psi_{JB}: T_J = T_B + \Psi_{JB} \times P_D$$

where:

- $P_D$  is the power dissipated as explained in [公式 5](#)
- $T_T$  is the temperature at the center-top of the device package, and
- $T_B$  is the PCB surface temperature measured 1 mm from the device package and centered on the package edge

(8)

### 8.1.15 TPS7A52EVM Thermal Analysis

The [TPS7A53EVM](#) is used to develop the TPS7A5401RPS thermal model. The RPS package is a 2.2-mm x 2.5-mm, 12-pin VQFN with 25- $\mu$ m plating on each via. The EVM is a 3-inch by 3-inch (7.62 mm x 7.62 mm) PCB comprised of four layers. [表 6](#) lists an overview of the EVM stackup. [图 48](#) 到 [图 52](#) provide layer details for the EVM.

表 6. Stackup

LAYER	NAME	MATERIAL	THICKNESS (mil)
1	Top overlay	—	—
2	Top solder	Solder resist	0.40
3	Top layer	Copper	1.40
4	Dielectric 1	FR-4, high T <sub>G</sub>	18.50
5	Mid layer 1	Copper	1.40
6	Dielectric 2	FR-4, high T <sub>G</sub>	18.60
7	Mid layer 2	Copper	1.40
8	Dielectric 3	FR-4, high T <sub>G</sub>	18.50
9	Bottom layer	Copper	1.40
10	Bottom solder	Solder resist	0.40

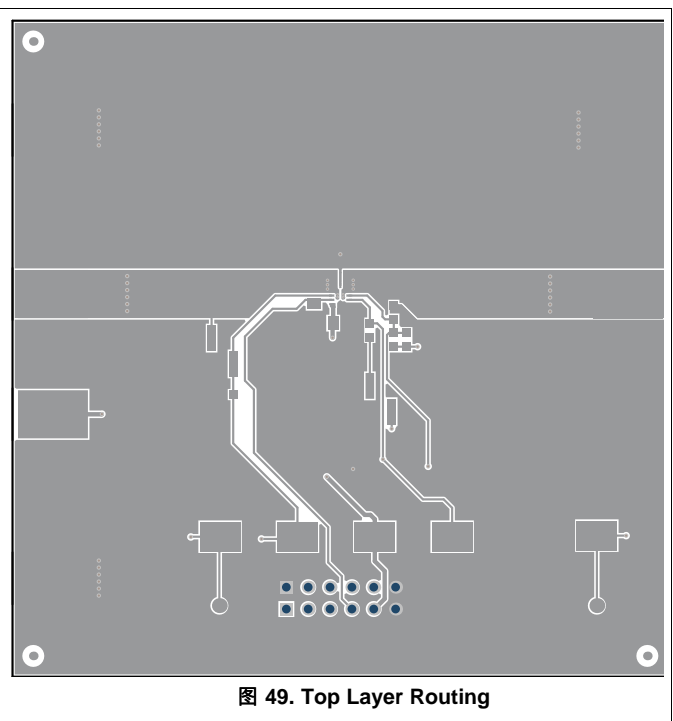
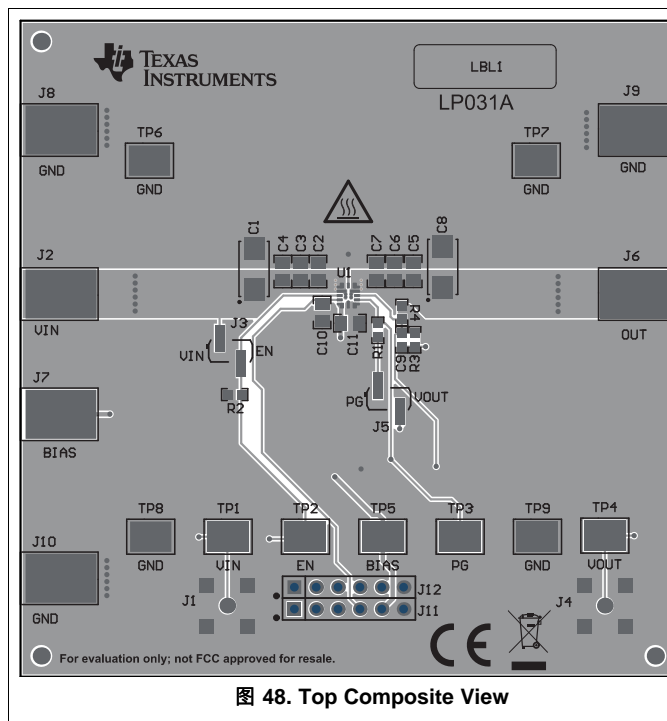



图 50. Mid Layer 1 Routing



图 51. Mid Layer 2 Routing

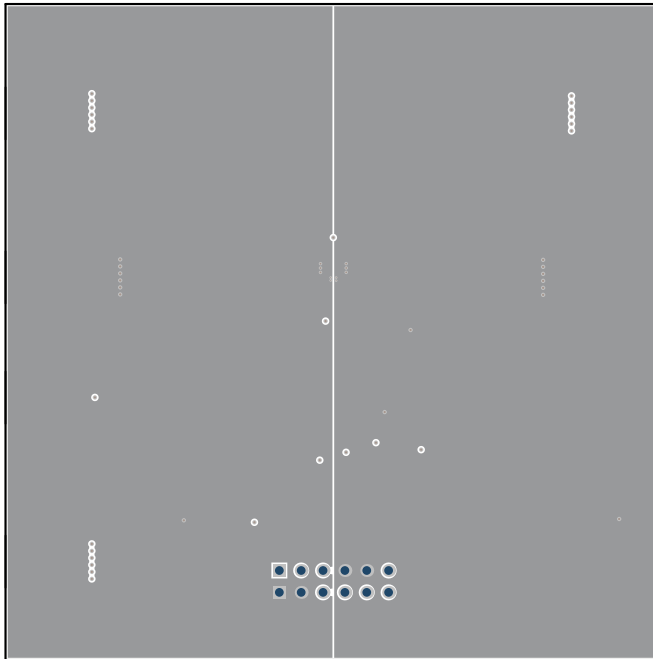

图 52. Bottom Layer Routing

图 53 shows the thermal gradient on the PCB that results when a 1-W power dissipation is used through the PassFET with a 25°C ambient temperature.

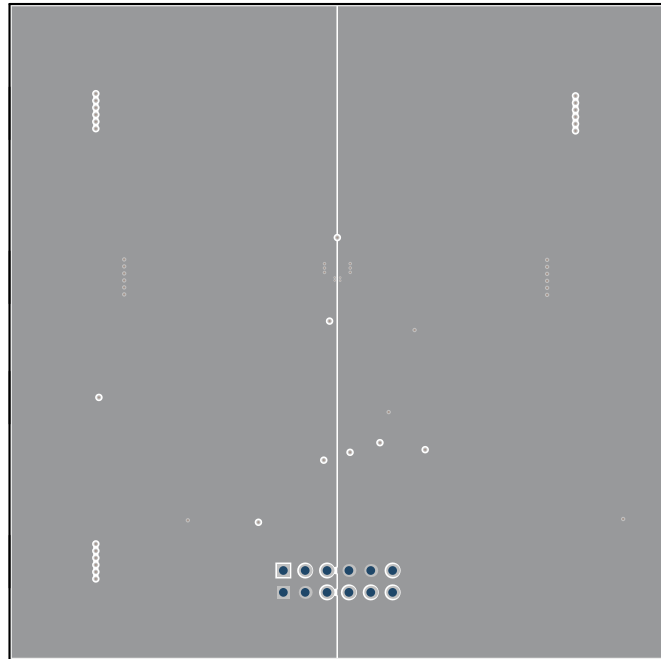

图 53. PCB Thermal Gradient

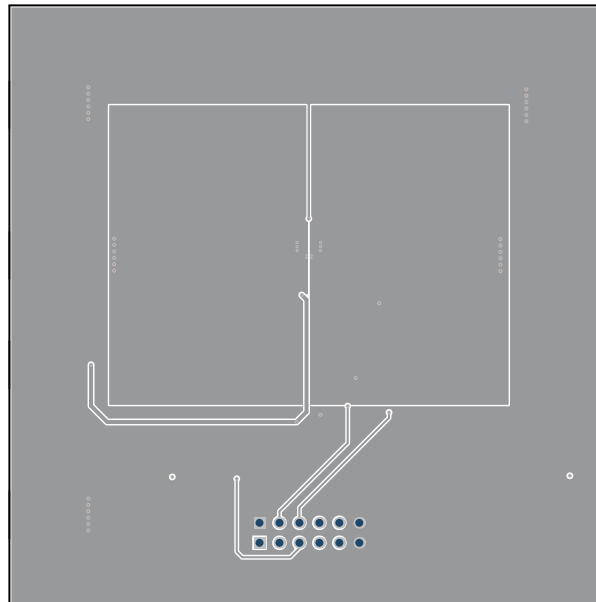
For additional information on the PCB, see the [TPS7A53EVM user guide](#).

## 8.2 Typical Application

This section discusses the implementation of the TPS7A52 using an adjustable feedback network to regulate a 4-A load requiring good PSRR at high frequency with low-noise at an output voltage of 0.9 V. 图 54 provides a schematic for this typical application circuit.

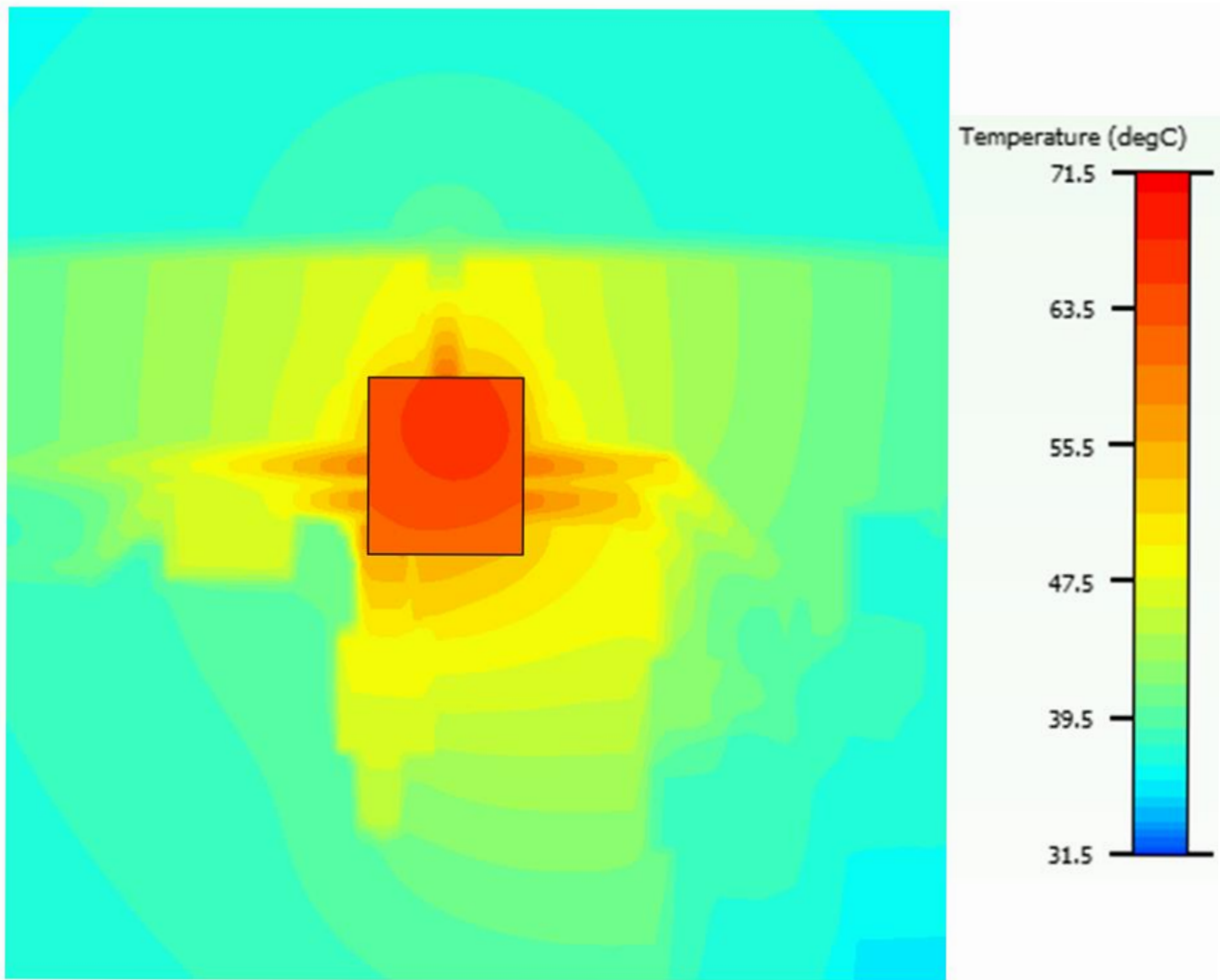

图 54. Typical Application for a 0.9-V Rail

### 8.2.1 Design Requirements

For this design example, use the parameters listed in 表 7 as the input parameters.

表 7. Design Parameters

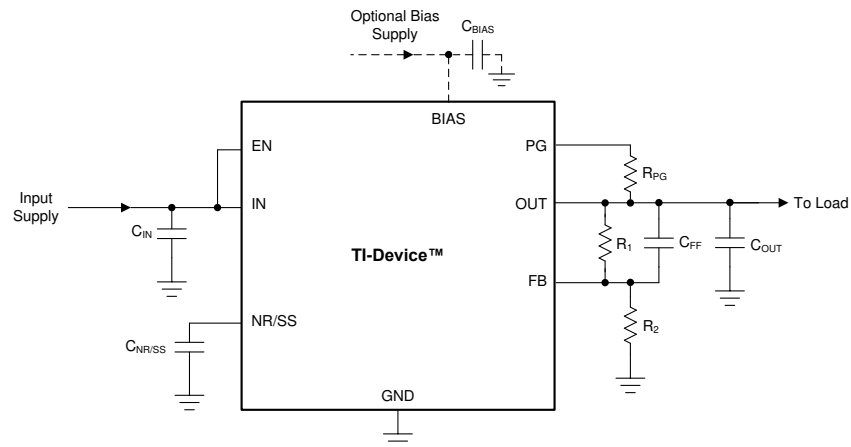
PARAMETER	DESIGN REQUIREMENT
Input voltage	1.2 V, $\pm 3\%$ , provided by the dc/dc converter switching at 500 kHz
Bias voltage	5V, $\pm 5\%$
Output voltage	0.9 V, $\pm 1\%$
Output current	4.0 A (maximum), 100 mA (minimum)
RMS noise, 10 Hz to 100 kHz	$< 10 \mu\text{V}_{\text{RMS}}$
PSRR at 500 kHz	$> 40 \text{ dB}$
Start-up time	$< 25 \text{ ms}$

### 8.2.2 Detailed Design Procedure

At 4.0 A and 0.9 V<sub>OUT</sub>, the dropout of the TPS7A52 has a 240-mV maximum dropout over temperature; thus, a 300-mV headroom is sufficient for operation over both input and output voltage accuracy. At full load and high temperature on some devices, the TPS7A52 can enter dropout if both the input and output supply are beyond the edges of the respective accuracy specification.

For a 0.9-V output, use external adjustable resistors. See the resistor values in listed 表 5 for choosing resistors for a 0.9 V output.

Input and output capacitors are selected in accordance with the [Recommended Capacitor Types](#) section. Ceramic capacitances of 47  $\mu\text{F}$  for the input and one 47- $\mu\text{F}$  capacitor in parallel with two 10- $\mu\text{F}$  capacitors for the output are selected.

To satisfy the required start-up time and still maintain low noise performance, a 100-nF C<sub>NR/SS</sub> is selected. 公式 9 calculates this value.

$$t_{\text{SS}} = (V_{\text{NR/SS}} \times C_{\text{NR/SS}}) / I_{\text{NR/SS}} \quad (9)$$

At the 4.0-A maximum load, the internal power dissipation is 1.2 W and corresponds to a 52°C junction temperature rise for the RPS package on a standard JEDEC board. With a 55°C maximum ambient temperature, the junction temperature is at 107.0°C. To further minimize noise, a feed-forward capacitance (C<sub>FF</sub>) of 10 nF is selected.

### 8.2.3 Application Curves

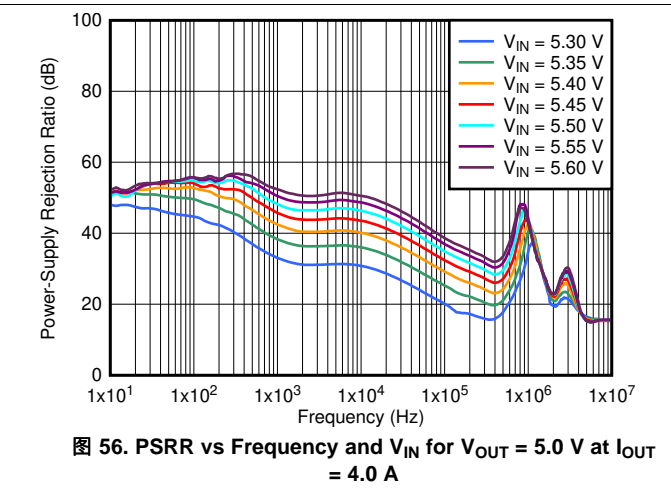
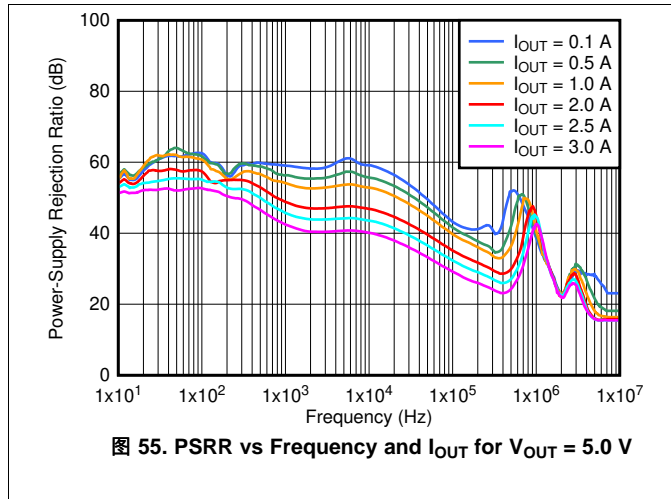

## 9 Power Supply Recommendations

The TPS7A52 is designed to operate from an input voltage supply range between 1.1 V and 6.5 V. If the input supply is less than 1.4 V, then a bias rail of at least 3.0 V must be used. The input voltage range provides adequate headroom in order for the device to have a regulated output. This input supply must be well regulated. If the input supply is noisy, use additional input capacitors with low ESR to help improve output noise performance.

## 10 Layout

### 10.1 Layout Guidelines

#### 10.1.1 Board Layout

For best overall performance, place all circuit components on the same side of the circuit board and as near as practical to the respective LDO pin connections. Place ground return connections to the input and output capacitor, and to the LDO ground pin as close to each other as possible, connected by a wide, component-side, copper surface. To avoid negative system performance, do not use of vias and long traces to the input and output capacitors. The grounding and layout scheme illustrated in [图 57](#) minimizes inductive parasitics, and thereby reduces load-current transients, minimizes noise, and increases circuit stability.

To improve performance, use a ground reference plane, either embedded in the PCB itself or placed on the bottom side of the PCB opposite the components. This reference plane serves to assure accuracy of the output voltage, shield noise, and behaves similar to a thermal plane to spread (or sink) heat from the LDO device when connected to the thermal pad. In most applications, this ground plane is necessary to meet thermal requirements.



## 10.2 Layout Example



图 57. Example Layout

## 11 器件和文档支持

### 11.1 器件支持

#### 11.1.1 开发支持

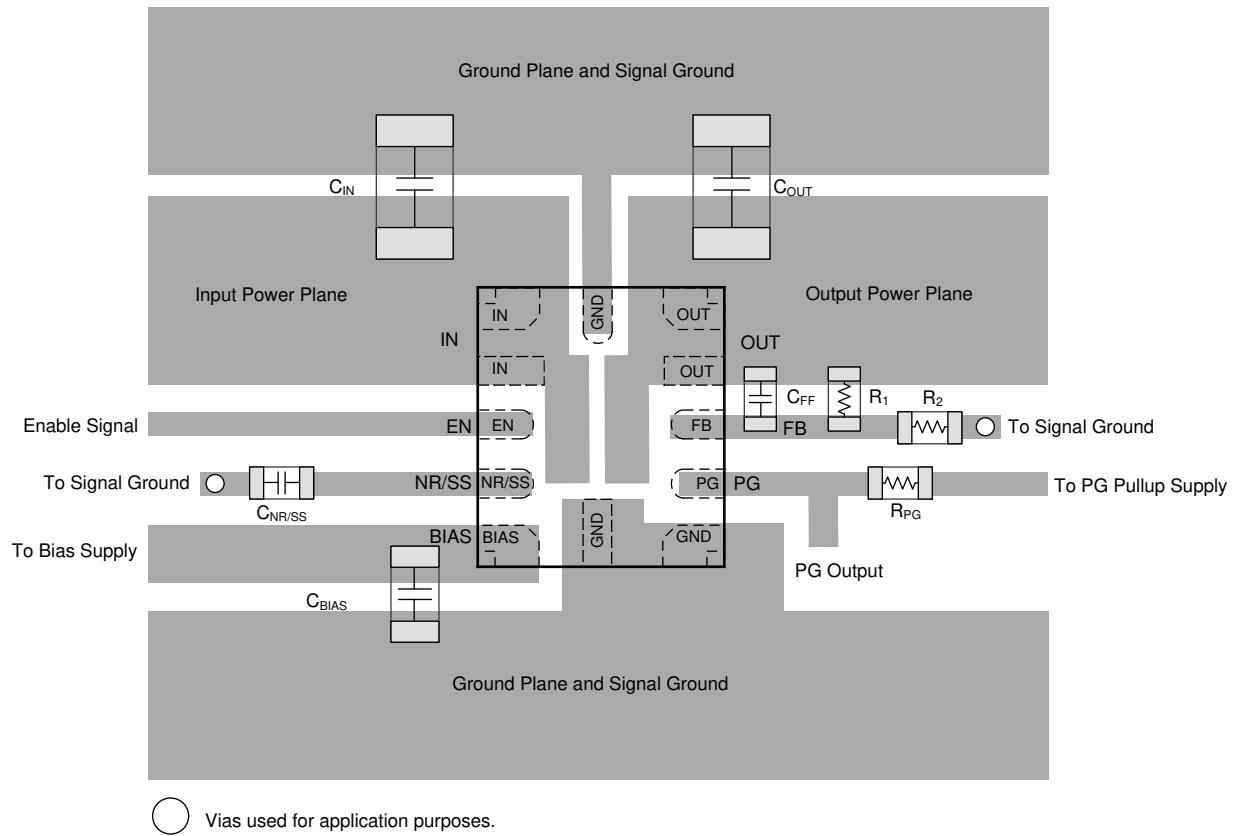
##### 11.1.1.1 评估模块

我们为您提供了评估模块 (EVM)，可以借此来对使用 TPS7A53 时的电路性能进行初始评估。表 8 显示了此装置的摘要信息。

表 8. 设计套件与评估模块

名称	文献编号
TPS7A5300EVM-TDB 评估模块	SBVS059

可通过德州仪器 (TI) [网站](http://www.ti.com.cn) 上的 TPS7A53 产品文件夹来申请获取该 EVM。

##### 11.1.1.2 Spice 模型

分析模拟电路和系统的性能时，使用 SPICE 模型对电路性能进行计算机仿真非常有用。您可以通过 TPS7A53 产品文件夹在仿真模型下获取 TPS7A53 的 SPICE 模型。

#### 11.1.2 器件命名规则

表 9. 订购信息<sup>(1)</sup>

产品	说明
TPS7A5301YYYZ	YYY 为封装标识符。 Z 为封装数量。

(1) 欲获得最新的封装和订货信息，请参阅本文档末尾的封装选项附录，或者访问 [www.ti.com.cn](http://www.ti.com.cn) 查看器件产品文件夹。

### 11.2 文档支持

#### 11.2.1 相关文档

请参阅如下相关文档：

- 德州仪器 (TI)，《TPS3702 高精度、过压和欠压监视器》数据表
- 德州仪器 (TI)，《TPS7A53EVM-031 评估模块》用户指南
- 德州仪器 (TI)，《使用前馈电容器和低压降稳压器的优缺点》应用报告
- 德州仪器 (TI)，《6A 电流均流双路 LDO》参考指南

#### 11.3 接收文档更新通知

要接收文档更新通知，请导航至 [ti.com.cn](http://ti.com.cn) 上的器件产品文件夹。单击右上角的通知我进行注册，即可每周接收产品信息更改摘要。有关更改的详细信息，请查看任何已修订文档中包含的修订历史记录。

#### 11.4 社区资源

TI E2E™ support forums are an engineer's go-to source for fast, verified answers and design help — straight from the experts. Search existing answers or ask your own question to get the quick design help you need.

Linked content is provided "AS IS" by the respective contributors. They do not constitute TI specifications and do not necessarily reflect TI's views; see TI's [Terms of Use](#).

## 11.5 商标

E2E is a trademark of Texas Instruments.  
All other trademarks are the property of their respective owners.

## 11.6 静电放电警告



ESD 可能会损坏该集成电路。德州仪器 (TI) 建议通过适当的预防措施处理所有集成电路。如果不遵守正确的处理措施和安装程序，可能会损坏集成电路。

ESD 的损坏小至导致微小的性能降级，大至整个器件故障。精密的集成电路可能更容易受到损坏，这是因为非常细微的参数更改都可能会导致器件与其发布的规格不相符。

## 11.7 Glossary

[SLYZ022](#) — *TI Glossary*.

This glossary lists and explains terms, acronyms, and definitions.

## 12 机械、封装和可订购信息

以下页面包含机械、封装和可订购信息。这些信息是指定器件的最新可用数据。数据如有变更，恕不另行通知，且不会对此文档进行修订。如需获取此数据表的浏览器版本，请查阅左侧的导航栏。

RPS0012A

PACKAGE OUTLINE  
VQFN-HR - 1 mm max height

PLASTIC QUAD FLATPACK-NO LEAD

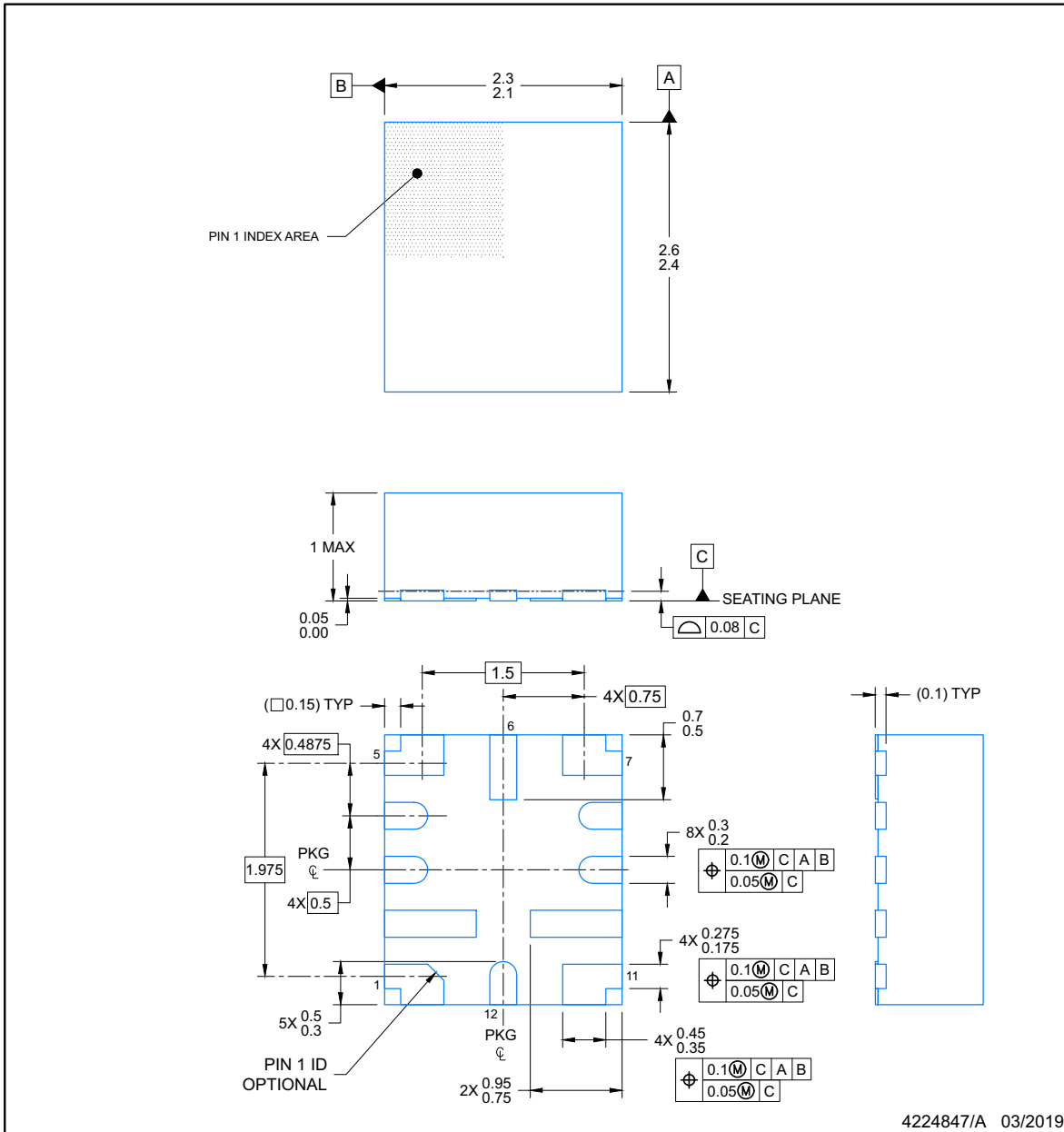

NOTES:

1. All linear dimensions are in millimeters. Any dimensions in parenthesis are for reference only. Dimensioning and tolerancing per ASME Y14.5M.
2. This drawing is subject to change without notice.



EXAMPLE STENCIL DESIGN

RPS0012A

VQFN-HR - 1 mm max height

PLASTIC QUAD FLATPACK-NO LEAD

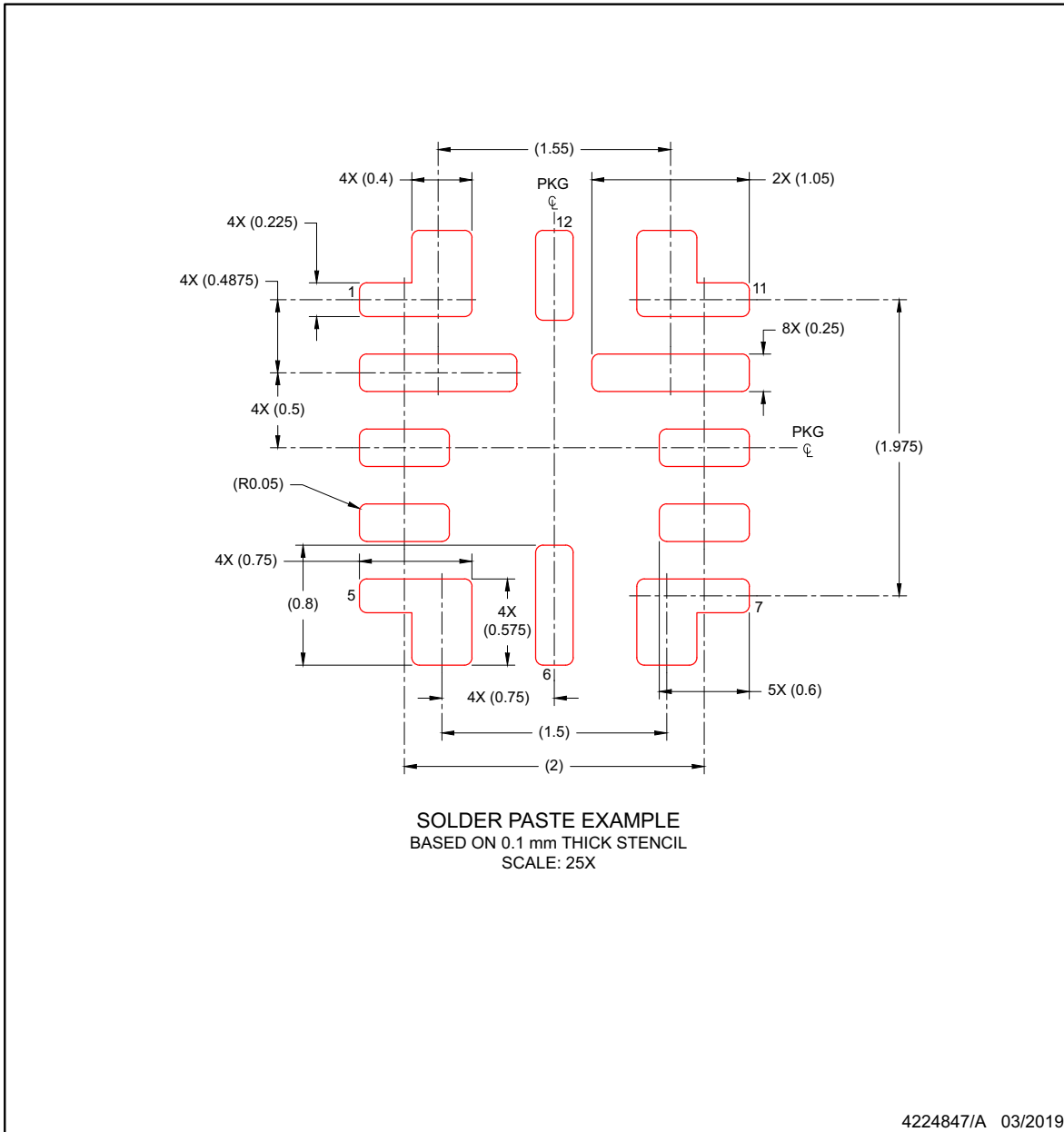

NOTES: (continued)

5. Laser cutting apertures with trapezoidal walls and rounded corners may offer better paste release. IPC-7525 may have alternate design recommendations.

**PACKAGING INFORMATION**

Orderable Device	Status (1)	Package Type	Package Drawing	Pins	Package Qty	Eco Plan (2)	Lead finish/ Ball material (6)	MSL Peak Temp (3)	Op Temp (°C)	Device Marking (4/5)	Samples
TPS7A5301RPSR	ACTIVE	VQFN-HR	RPS	12	3000	RoHS & Green	MATTE SN	Level-2-260C-1 YEAR	-40 to 125	21BH	<a href="#">Samples</a>
TPS7A5301RPST	ACTIVE	VQFN-HR	RPS	12	250	RoHS & Green	MATTE SN	Level-2-260C-1 YEAR	-40 to 125	21BH	<a href="#">Samples</a>

(1) The marketing status values are defined as follows:

**ACTIVE:** Product device recommended for new designs.

**LIFEBUY:** TI has announced that the device will be discontinued, and a lifetime-buy period is in effect.

**NRND:** Not recommended for new designs. Device is in production to support existing customers, but TI does not recommend using this part in a new design.

**PREVIEW:** Device has been announced but is not in production. Samples may or may not be available.

**OBSOLETE:** TI has discontinued the production of the device.

(2) **RoHS:** TI defines "RoHS" to mean semiconductor products that are compliant with the current EU RoHS requirements for all 10 RoHS substances, including the requirement that RoHS substance do not exceed 0.1% by weight in homogeneous materials. Where designed to be soldered at high temperatures, "RoHS" products are suitable for use in specified lead-free processes. TI may reference these types of products as "Pb-Free".

**RoHS Exempt:** TI defines "RoHS Exempt" to mean products that contain lead but are compliant with EU RoHS pursuant to a specific EU RoHS exemption.

**Green:** TI defines "Green" to mean the content of Chlorine (Cl) and Bromine (Br) based flame retardants meet JS709B low halogen requirements of <=1000ppm threshold. Antimony trioxide based flame retardants must also meet the <=1000ppm threshold requirement.

(3) MSL, Peak Temp. - The Moisture Sensitivity Level rating according to the JEDEC industry standard classifications, and peak solder temperature.

(4) There may be additional marking, which relates to the logo, the lot trace code information, or the environmental category on the device.

(5) Multiple Device Markings will be inside parentheses. Only one Device Marking contained in parentheses and separated by a "~" will appear on a device. If a line is indented then it is a continuation of the previous line and the two combined represent the entire Device Marking for that device.

(6) Lead finish/Ball material - Orderable Devices may have multiple material finish options. Finish options are separated by a vertical ruled line. Lead finish/Ball material values may wrap to two lines if the finish value exceeds the maximum column width.

**Important Information and Disclaimer:**The information provided on this page represents TI's knowledge and belief as of the date that it is provided. TI bases its knowledge and belief on information provided by third parties, and makes no representation or warranty as to the accuracy of such information. Efforts are underway to better integrate information from third parties. TI has taken and continues to take reasonable steps to provide representative and accurate information but may not have conducted destructive testing or chemical analysis on incoming materials and chemicals. TI and TI suppliers consider certain information to be proprietary, and thus CAS numbers and other limited information may not be available for release.

In no event shall TI's liability arising out of such information exceed the total purchase price of the TI part(s) at issue in this document sold by TI to Customer on an annual basis.



**OTHER QUALIFIED VERSIONS OF TPS7A53 :**

- Automotive : [TPS7A53-Q1](#)

## NOTE: Qualified Version Definitions:

- Automotive - Q100 devices qualified for high-reliability automotive applications targeting zero defects

## TAPE AND REEL INFORMATION



### QUADRANT ASSIGNMENTS FOR PIN 1 ORIENTATION IN TAPE



\*All dimensions are nominal

Device	Package Type	Package Drawing	Pins	SPQ	Reel Diameter (mm)	Reel Width W1 (mm)	A0 (mm)	B0 (mm)	K0 (mm)	P1 (mm)	W (mm)	Pin1 Quadrant
TPS7A5301RPSR	VQFN-HR	RPS	12	3000	180.0	12.4	2.45	2.75	1.2	4.0	12.0	Q1
TPS7A5301RPST	VQFN-HR	RPS	12	250	180.0	12.4	2.45	2.75	1.2	4.0	12.0	Q1

**TAPE AND REEL BOX DIMENSIONS**

\*All dimensions are nominal

Device	Package Type	Package Drawing	Pins	SPQ	Length (mm)	Width (mm)	Height (mm)
TPS7A5301RPSR	VQFN-HR	RPS	12	3000	210.0	185.0	35.0
TPS7A5301RPST	VQFN-HR	RPS	12	250	210.0	185.0	35.0

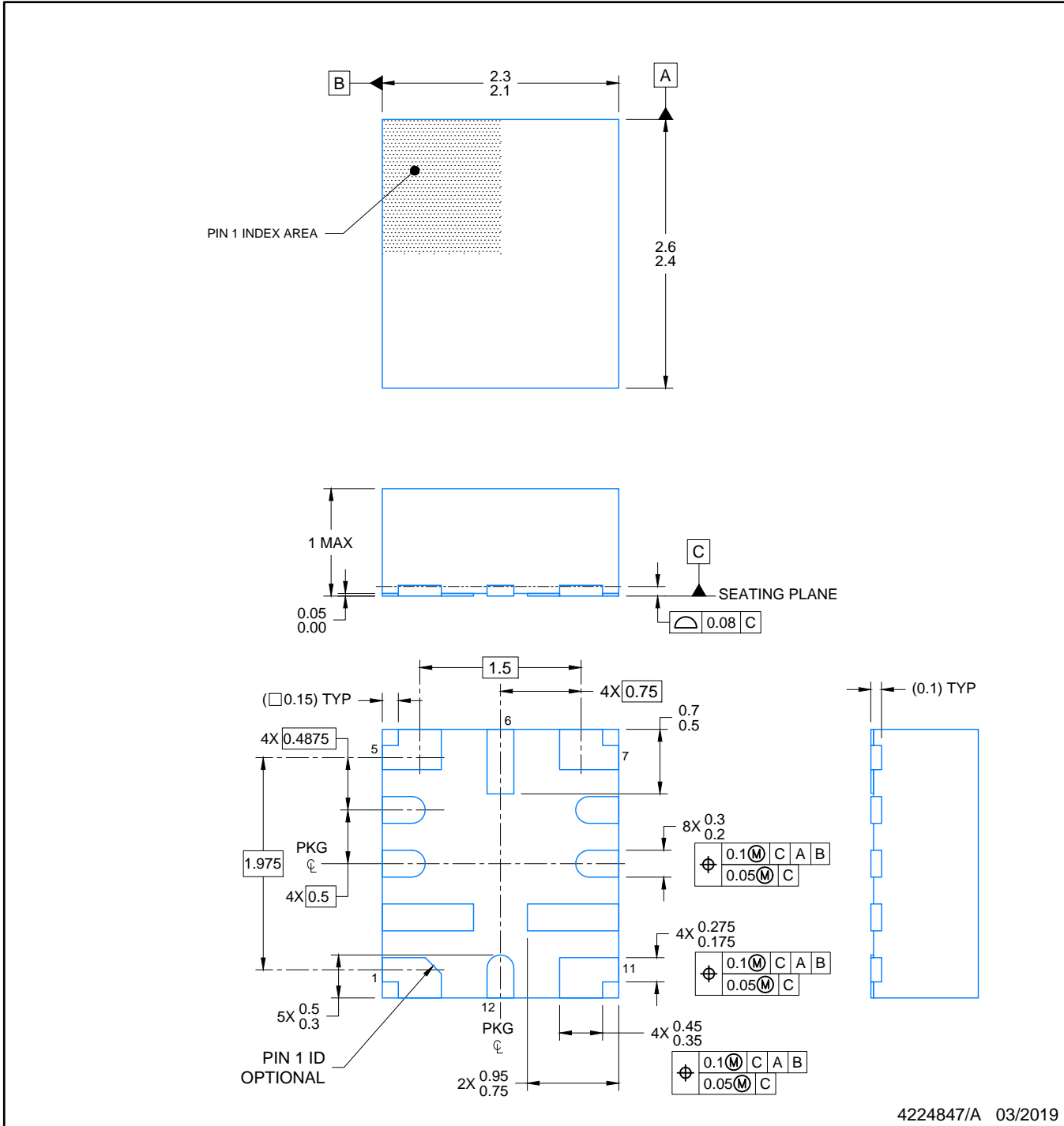

4224847/A 03/2019

NOTES:

1. All linear dimensions are in millimeters. Any dimensions in parenthesis are for reference only. Dimensioning and tolerancing per ASME Y14.5M.
2. This drawing is subject to change without notice.

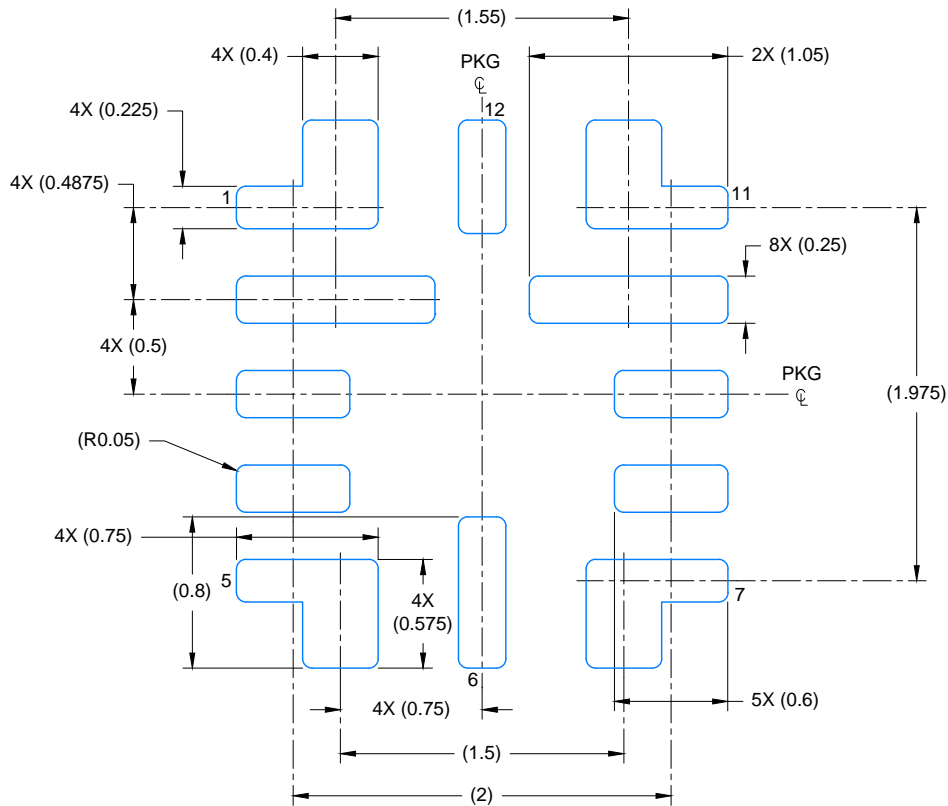

LAND PATTERN EXAMPLE  
EXPOSED METAL SHOWN  
SCALE: 25X

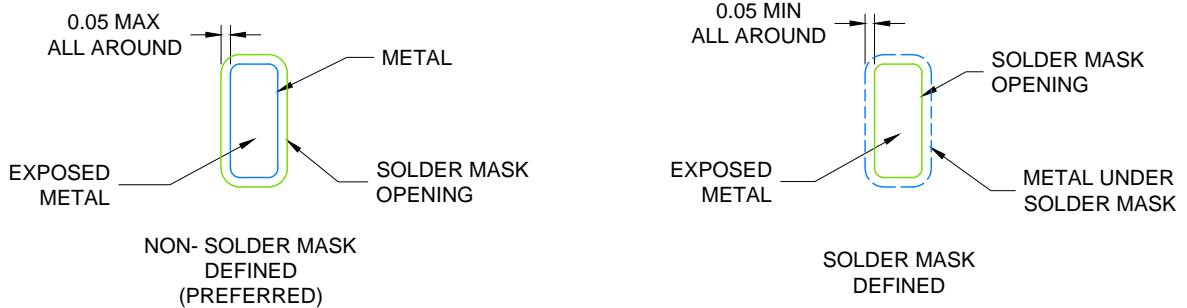

SOLDER MASK DETAILS

4224847/A 03/2019

NOTES: (continued)

3. For more information, see Texas Instruments literature number SLUA271 ([www.ti.com/lit/sluea271](http://www.ti.com/lit/sluea271)).
4. Solder mask tolerances between and around signal pads can vary based on board fabrication site.



## 重要声明和免责声明

TI“按原样”提供技术和可靠性数据（包括数据表）、设计资源（包括参考设计）、应用或其他设计建议、网络工具、安全信息和其他资源，不保证没有瑕疵且不做任何明示或暗示的担保，包括但不限于对适销性、某特定用途方面的适用性或不侵犯任何第三方知识产权的暗示担保。

这些资源可供使用 TI 产品进行设计的熟练开发人员使用。您将自行承担以下全部责任：(1) 针对您的应用选择合适的 TI 产品，(2) 设计、验证并测试您的应用，(3) 确保您的应用满足相应标准以及任何其他功能安全、信息安全、监管或其他要求。

这些资源如有变更，恕不另行通知。TI 授权您仅可将这些资源用于研发本资源所述的 TI 产品的应用。严禁对这些资源进行其他复制或展示。您无权使用任何其他 TI 知识产权或任何第三方知识产权。您应全额赔偿因在这些资源的使用中对 TI 及其代表造成的任何索赔、损害、成本、损失和债务，TI 对此概不负责。

TI 提供的产品受 [TI 的销售条款](#) 或 [ti.com](#) 上其他适用条款/TI 产品随附的其他适用条款的约束。TI 提供这些资源并不会扩展或以其他方式更改 TI 针对 TI 产品发布的适用的担保或担保免责声明。

TI 反对并拒绝您可能提出的任何其他或不同的条款。

邮寄地址：Texas Instruments, Post Office Box 655303, Dallas, Texas 75265

Copyright © 2022，德州仪器 (TI) 公司

## X-ON Electronics

Largest Supplier of Electrical and Electronic Components

*Click to view similar products for [LDO Voltage Regulators](#) category:*

*Click to view products by [Texas Instruments](#) manufacturer:*

Other Similar products are found below :

[AP7363-SP-13](#) [NCV8664CST33T3G](#) [L79M05TL-E](#) [AP7362-HA-7](#) [PT7M8202B12TA5EX](#) [TCR3DF185,LM\(CT](#) [TLF4949EJ](#)  
[NCP4687DH15T1G](#) [NCV8703MX30TCG](#) [LP2951CN](#) [NCV4269CPD50R2G](#) [AP7315-25W5-7](#) [NCV47411PAAJR2G](#) [AP2111H-1.2TRG1](#)  
[ZLDO1117QK50TC](#) [AZ1117ID-ADJTRG1](#) [NCV4263-2CPD50R2G](#) [NCP114BMX075TCG](#) [MC33269T-3.5G](#) [TLE4471GXT](#) [AP7315-33SA-](#)  
[7](#) [NCV4266-2CST33T3G](#) [NCP715SQ15T2G](#) [NCV8623MN-50R2G](#) [NCV563SQ18T1G](#) [NCV8664CDT33RKG](#) [NCV4299CD250R2G](#)  
[NCP715MX30TBG](#) [NCV8702MX25TCG](#) [TLE7270-2E](#) [NCV562SQ25T1G](#) [AP2213D-3.3TRG1](#) [AP2202K-2.6TRE1](#)  
[NCV8170BMX300TCG](#) [NCV8152MX300180TCG](#) [NCP700CMT45TBG](#) [AP7315-33W5-7](#) [NCP154MX180300TAG](#) [AP2113AMTR-G1](#)  
[NJV4104U2-33A-TE1](#) [MP2013AGG-5-P](#) [NCV8775CDT50RKG](#) [NJM2878F3-45-TE1](#) [S-19214B00A-V5T2U7](#) [S-19214B50A-V5T2U7](#) [S-](#)  
[19213B50A-V5T2U7](#) [S-19214BC0A-E8T1U7\\*1](#) [S-19213B00A-V5T2U7](#) [S-19213B33A-V5T2U7](#) [S-19213BC0A-V5T2U7](#)