

TPS7B81 150mA、40V、超低 I_Q 低压降稳压器

1 特性

- 宽输入电压范围：3V 至 40V
- 输出电流：150mA
- 超低静态电流 (I_Q):
 - 轻负载时典型值为 2.7 μ A
 - 轻负载时最大值为 4.5 μ A
- 精度：整个线路、负载和温度范围内为 1.5%
- 典型压降电压：180mV（电流为 100mA）
- 宽使能电压范围：2V 至 V_{IN} （最大值为 40V）
- 输入电压瞬态容差：45V
- 5V 和 3.3V 固定输出选项
- 电流限制和热关断保护
- 与多种电容（1 μ F 至 200 μ F）搭配使用可保持稳定⁽¹⁾
- 结温范围：-40°C 至 +150°C
- 高热性能封装：
 - DGN（8 引脚 HVSSOP）， $R_{\theta JA} = 63.9^\circ\text{C/W}$
 - DRV（6 引脚 WSON）， $R_{\theta JA} = 72.8^\circ\text{C/W}$

(1) 请参阅 [建议运行条件](#) 表中的输出电容要求

2 应用

- 烟雾和热量探测器
- 恒温器
- 运动检测器（PIR、uWave 等）
- 无线电动工具
- 电器电池组
- 电机驱动器

T48 路多路复用 LC6948

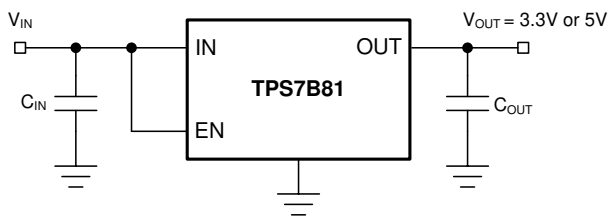

3 说明

TPS7B81 是一款低压降 (LDO) 线性稳压器，可在高达 40V 的输入电压下工作，并可提供高达 150mA 的电流。该器件在轻负载时的静态电流仅为 2.7 μ A，非常适合需要极低待机功耗的宽输入电源设计和高电池节数电池应用。45V 的瞬态容差为可能存在电感反冲的应用提供了额外的裕量，从而减少了用于电压抑制的外部电路。

TPS7B81 具有集成的短路和过流限制功能，可在故障条件下为系统提供保护。除了低待机功耗外，轻负载条件下的极低压降电压也有助于维持电压稳定，即使在电池耗尽的情况下，也是如此。

TPS7B81 采用热增强型 8 引脚 HVSSOP 和 6 引脚 WSON 封装。这两种封装均具有较高的导热率，而且它们的尺寸较小，可支持紧凑型设计，非常适合用于空间受限的应用，例如电动工具或电机驱动模块和电池组。

器件信息⁽¹⁾

器件型号	封装	封装尺寸（标称值）
TPS7B81	HVSSOP (8)	3.00mm × 3.00mm
	WSON (6)	2.00mm × 2.00mm

(1) 如需了解所有可用封装，请参阅数据表末尾的可订购产品附录。

静态电流与环境温度间的关系 ($V_{OUT} = 3.3V$)

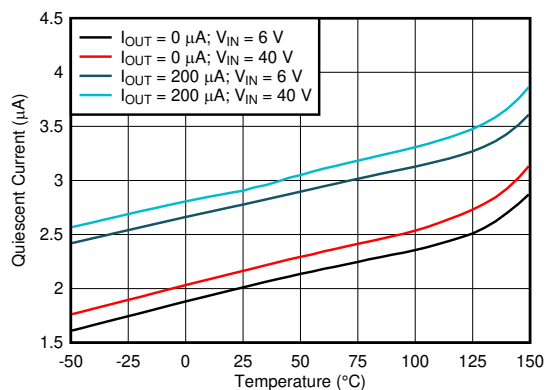

目录

1	特性	1	7.4	Device Functional Modes.....	11
2	应用	1	8	Application and Implementation	12
3	说明	1	8.1	Application Information.....	12
4	修订历史记录	2	8.2	Typical Application	15
5	Pin Configuration and Functions	3	9	Power Supply Recommendations	16
6	Specifications	4	10	Layout	17
6.1	Absolute Maximum Ratings	4	10.1	Layout Guidelines	17
6.2	ESD Ratings.....	4	10.2	Layout Example	17
6.3	Recommended Operating Conditions.....	4	11	器件和文档支持	18
6.4	Thermal Information	4	11.1	接收文档更新通知	18
6.5	Electrical Characteristics.....	5	11.2	支持资源	18
6.6	Typical Characteristics	6	11.3	商标	18
7	Detailed Description	10	11.4	静电放电警告	18
7.1	Overview	10	11.5	Glossary	18
7.2	Functional Block Diagram	10	12	机械、封装和可订购信息	18
7.3	Feature Description.....	10			

4 修订历史记录

注：之前版本的页码可能与当前版本有所不同。

日期	修订版本	说明
2020 年 4 月	*	初始发行版。

5 Pin Configuration and Functions

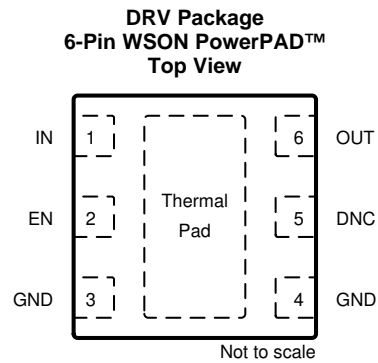
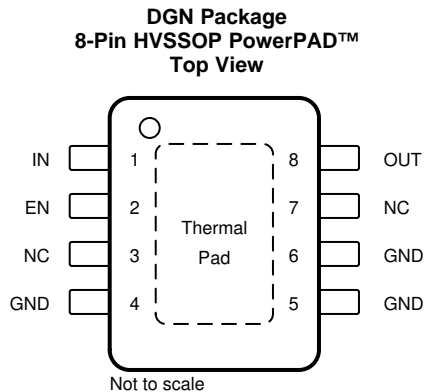

Pin Functions

NAME	PIN NO.		I/O	DESCRIPTION
	NO.			
	DGN	DRV		
DNC	—	5	—	Do not connect to a biased voltage. Tie this pin to ground or leave floating.
EN	2	2	I	Enable input pin. Drive EN greater than V_{IH} to turn on the regulator. Drive EN less than V_{IL} to put the low-dropout (LDO) into shutdown mode.
GND	4, 5, 6	3,4	—	Ground reference
IN	1	1	I	Input power-supply pin. For best transient response and to minimize input impedance, use the recommended value or larger ceramic capacitor from IN to ground as listed in the Recommended Operating Conditions table and the Input Capacitor section. Place the input capacitor as close to the output of the device as possible.
NC	3, 7	—	—	Not internally connected
OUT	8	6	O	Regulated output voltage pin. A capacitor is required from OUT to ground for stability. For best transient response, use the nominal recommended value or larger ceramic capacitor from OUT to ground; see the Recommended Operating Conditions table and the Output Capacitor section. Place the output capacitor as close to output of the device as possible.
Thermal pad			—	Connect the thermal pad to a large-area GND plane for improved thermal performance.

6 Specifications

6.1 Absolute Maximum Ratings

over operating ambient temperature range (unless otherwise noted)⁽¹⁾⁽²⁾

		MIN	MAX	UNIT
V _{IN}	Unregulated input voltage ⁽³⁾	-0.3	45	V
V _{EN}	Enable input voltage ⁽³⁾	-0.3	V _{IN}	V
V _{OUT}	Regulated output	-0.3	7	V
T _J	Junction temperature	-40	150	°C
T _{stg}	Storage temperature	-40	150	°C

- (1) Stresses beyond those listed under *Absolute Maximum Ratings* may cause permanent damage to the device. These are stress ratings only, which do not imply functional operation of the device at these or any other conditions beyond those indicated under *Recommended Operating Conditions*. Exposure to absolute-maximum-rated conditions for extended periods may affect device reliability.
- (2) All voltage values are with respect to GND.
- (3) Absolute maximum voltage, can withstand 45 V for 200 ms.

6.2 ESD Ratings

			VALUE	UNIT
V _(ESD)	Electrostatic discharge	Human body model (HBM), per ANSI/ESDA/JEDEC JS-001 ⁽¹⁾	±2000	V
		Charged device model (CDM), per JEDEC specification JESD22-C101 ⁽²⁾	±500	

- (1) JEDEC document JEP155 states that 2-kV HBM allows safe manufacturing with a standard ESD control process.
- (2) JEDEC document JEP157 states that 500-V CDM allows safe manufacturing with a standard ESD control process.

6.3 Recommended Operating Conditions

over operating ambient temperature range (unless otherwise noted)

		MIN	MAX	UNIT
V _{IN}	Unregulated input voltage	3	40	V
V _{EN}	Enable input voltage	0	V _{IN}	V
C _{OUT}	Output capacitor requirements ⁽¹⁾	1	200	μF
ESR	Output capacitor ESR requirements ⁽²⁾	0.001	5	Ω
T _A	Ambient temperature	-40	125	°C
T _J	Junction temperature	-40	150	°C

- (1) The output capacitance range specified in the table is the effective capacitance value.
- (2) Relevant ESR value at f = 10 kHz

6.4 Thermal Information

THERMAL METRIC ⁽¹⁾		TPS7B81		UNIT
		DGN (HVSSOP)	DRV (WSON)	
		8 PINS	6 PINS	
R _{θJA}	Junction-to-ambient thermal resistance	63.9	72.8	°C/W
R _{θJC(top)}	Junction-to-case (top) thermal resistance	50.2	85.8	°C/W
R _{θJB}	Junction-to-board thermal resistance	22.6	37.4	°C/W
ψ _{JT}	Junction-to-top characterization parameter	1.8	2.7	°C/W
ψ _{JB}	Junction-to-board characterization parameter	22.3	37.3	°C/W
R _{θJC(bot)}	Junction-to-case (bottom) thermal resistance	12.1	13.8	°C/W

- (1) For more information about traditional and new thermal metrics, see the [Semiconductor and IC Package Thermal Metrics application report](#).

6.5 Electrical Characteristics

over operating ambient temperature range, $T_J = -40^{\circ}\text{C}$ to $+150^{\circ}\text{C}$, $V_{IN} = 14\text{ V}$, and $10\text{-}\mu\text{F}$ ceramic output capacitor (unless otherwise noted)

PARAMETER		TEST CONDITIONS		MIN	TYP	MAX	UNIT	
SUPPLY VOLTAGE AND CURRENT (IN)								
V_{IN}	Input voltage			$V_{OUT(Nom)} + V_{(Dropout)}$		40	V	
$I_{(SD)}$	Shutdown current	$EN = 0\text{ V}$		0.3	1		μA	
$I_{(Q)}$	Quiescent current	$V_{IN} = 6\text{ V to }40\text{ V}, EN \geq 2\text{ V}, I_{OUT} = 0\text{ mA}$		1.9	3.5		μA	
		$V_{IN} = 6\text{ V to }40\text{ V}, EN \geq 2\text{ V}, I_{OUT} = 0.2\text{ mA}$	DGN package	2.7	6.5			
			DRV package	2.7	4.5			
$V_{(IN, UVLO)}$	V_{IN} undervoltage detection	Ramp V_{IN} down until the output turns off				2.7	V	
		Hysteresis				200	mV	
ENABLE INPUT (EN)								
V_{IL}	Logic-input low level					0.7	V	
V_{IH}	Logic-input high level			2			V	
I_{EN}	Enable current			10			nA	
REGULATED OUTPUT (OUT)								
V_{OUT}	Regulated output	$V_{IN} = V_{OUT} + V_{(Dropout)}$ to 40 V , $I_{OUT} = 1\text{ mA to }150\text{ mA}$		-1.5%		1.5%		
$V_{(Line-Reg)}$	Line regulation	$V_{IN} = 6\text{ V to }40\text{ V}, I_{OUT} = 10\text{ mA}$				10	mV	
$V_{(Load-Reg)}$	Load regulation	$V_{IN} = 14\text{ V}, I_{OUT} = 1\text{ mA to }150\text{ mA}$		DGN package		20	mV	
				DRV package		10		
$V_{(Dropout)}$	Dropout voltage	$V_{OUT} = 5\text{ V}$	$I_{OUT} = 150\text{ mA}$	DGN package		270	540	mV
				DRV package		325	585	
			$I_{OUT} = 100\text{ mA}$	DGN package		180	350	
		DRV package		200	390			
		$V_{OUT} = 3.3\text{ V}$	$I_{OUT} = 150\text{ mA}$	DGN package		650		
				DRV package		345	675	
$I_{OUT} = 100\text{ mA}$					255	450		
I_{OUT}	Output current	V_{OUT} in regulation, $V_{IN} = 7\text{ V}$ for the fixed 5-V option, $V_{IN} = 5.8\text{ V}$ for the fixed 3.3-V option		0		150	mA	
$I_{(CL)}$	Output current limit	V_{OUT} short to $90\% \times V_{OUT}$		180	510	690	mA	
PSRR	Power-supply ripple rejection	$V_{(Ripple)} = 0.5\text{ V}_{PP}$, $I_{OUT} = 10\text{ mA}$, frequency = 100 Hz , $C_{OUT} = 2.2\text{ }\mu\text{F}$		60			dB	
OPERATING TEMPERATURE RANGE								
$T_{(SD)}$	Junction shutdown temperature			175			$^{\circ}\text{C}$	
$T_{(HYST)}$	Hysteresis of thermal shutdown			20			$^{\circ}\text{C}$	

6.6 Typical Characteristics

at $T_J = -40^{\circ}\text{C}$ to $+150^{\circ}\text{C}$, $V_{IN} = 14\text{ V}$, and $V_{EN} \geq 2\text{ V}$ (unless otherwise noted)



图 1. Shutdown Current vs Ambient Temperature



图 2. Quiescent Current vs Ambient Temperature

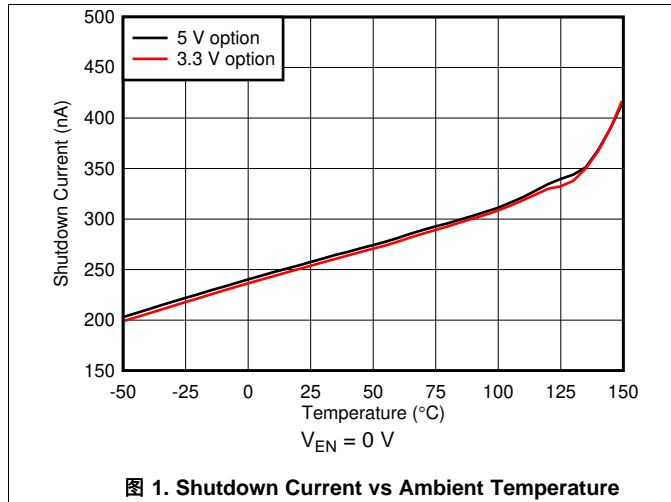

图 3. Quiescent Current vs Ambient Temperature

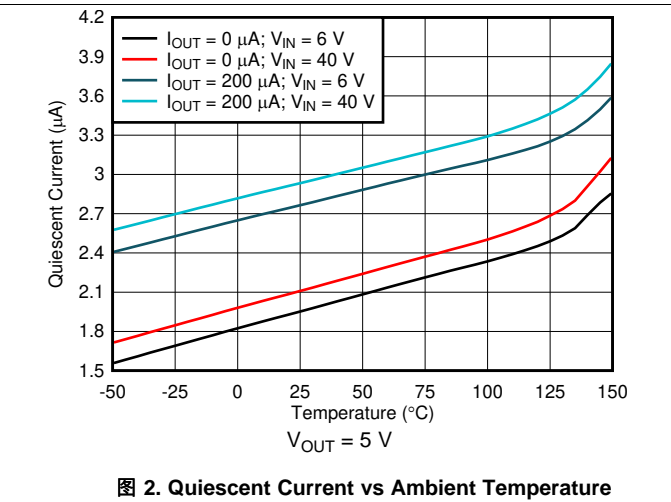

图 4. Dropout Voltage vs Output Current

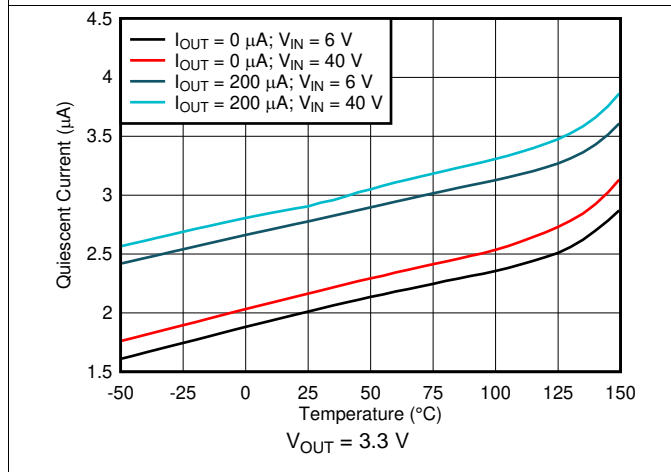

图 5. Dropout Voltage vs Output Current

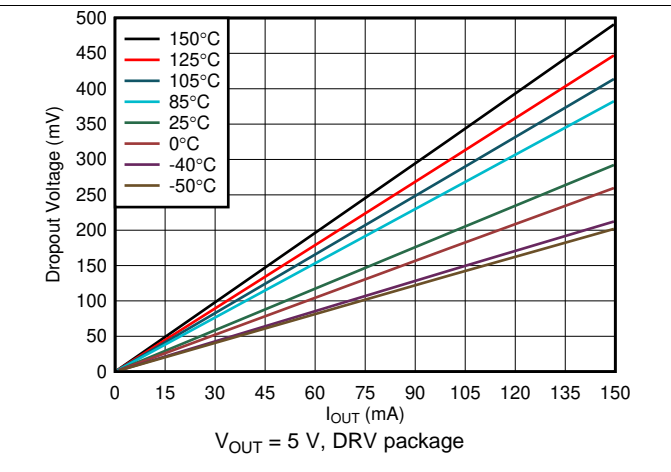

图 6. Dropout Voltage vs Ambient Temperature

Typical Characteristics (接下页)

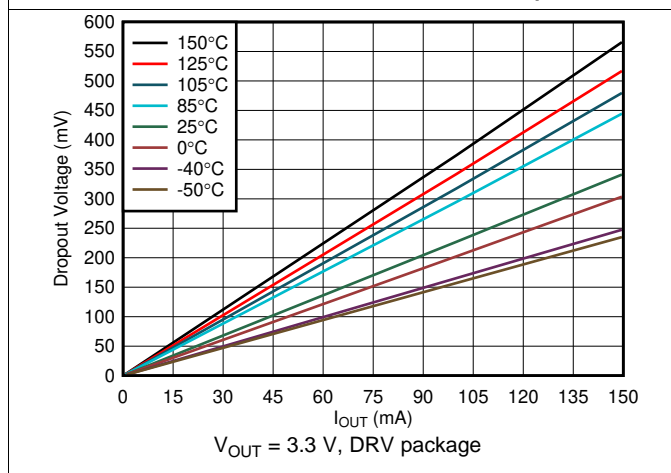
at $T_J = -40^{\circ}\text{C}$ to $+150^{\circ}\text{C}$, $V_{IN} = 14\text{ V}$, and $V_{EN} \geq 2\text{ V}$ (unless otherwise noted)

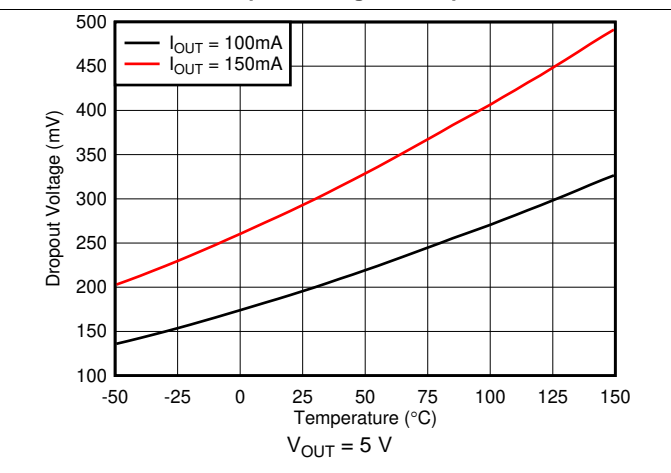
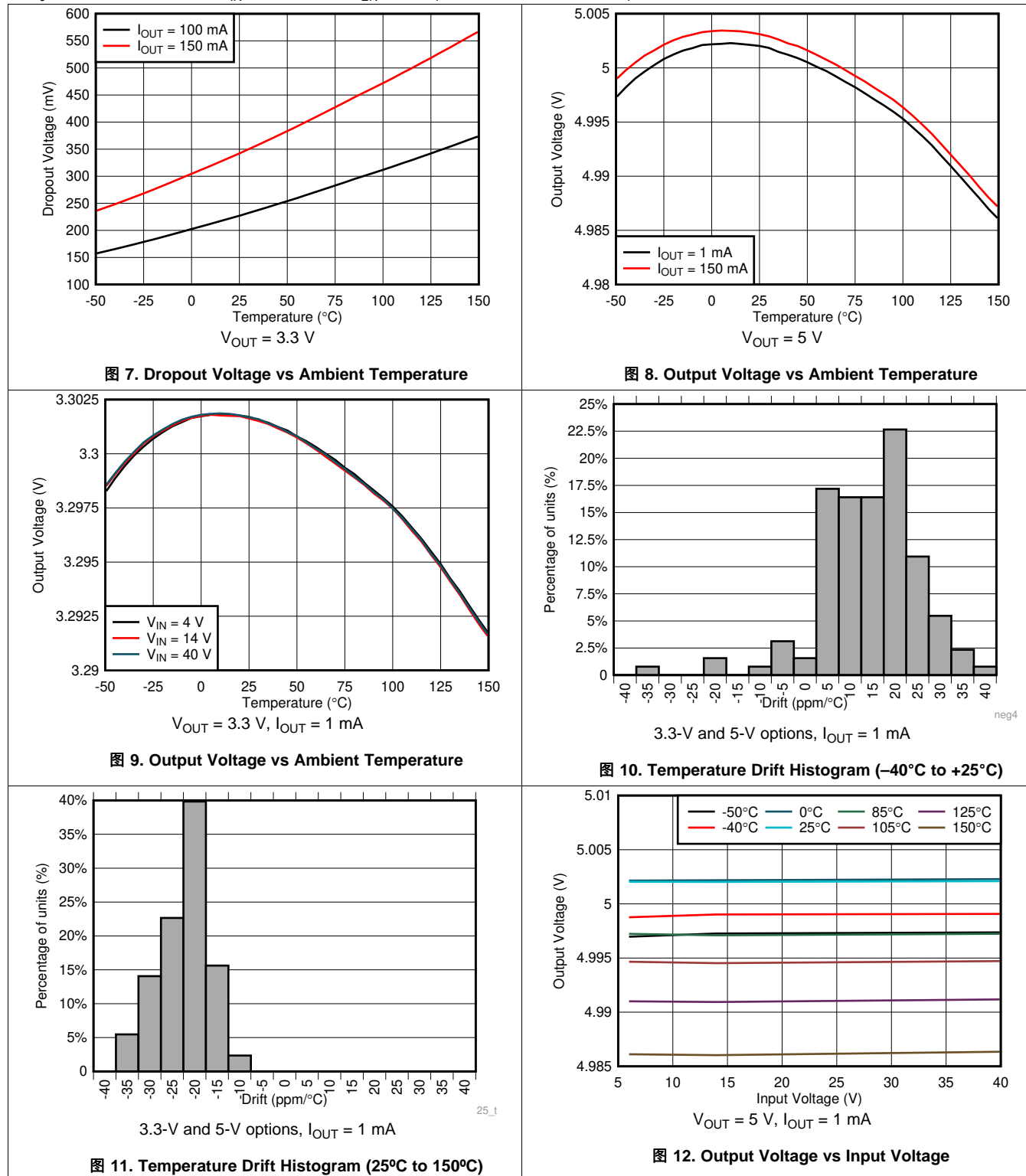

Typical Characteristics (接下页)

at $T_J = -40^{\circ}\text{C}$ to $+150^{\circ}\text{C}$, $V_{IN} = 14\text{ V}$, and $V_{EN} \geq 2\text{ V}$ (unless otherwise noted)



图 13. Output Voltage vs Input Voltage



图 14. Output Current Limit vs Ambient Temperature

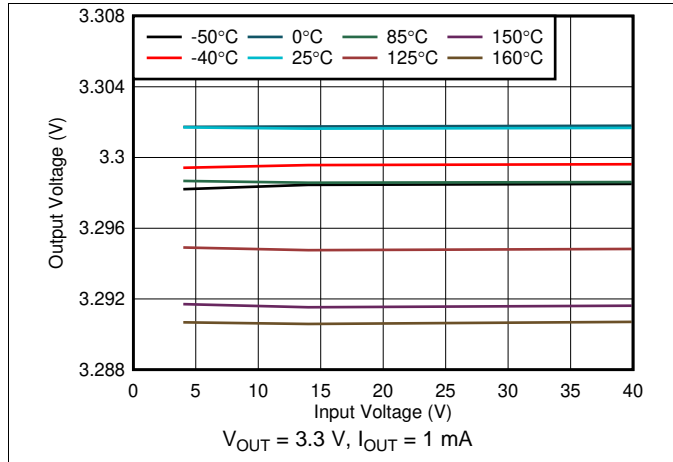

图 15. Enable Voltage vs Ambient Temperature

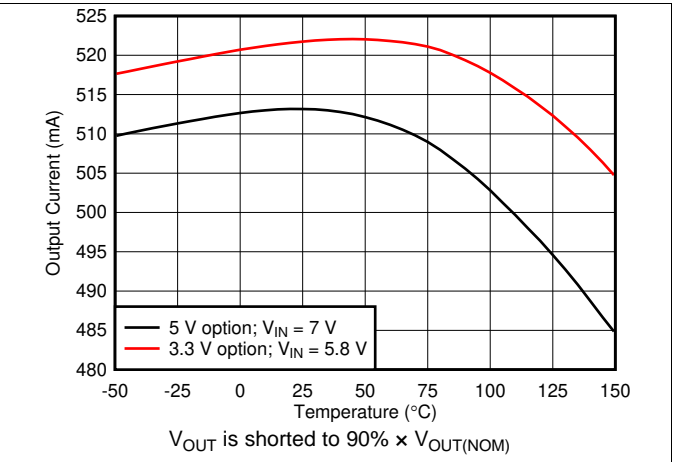

图 16. Enable Current vs Ambient Temperature

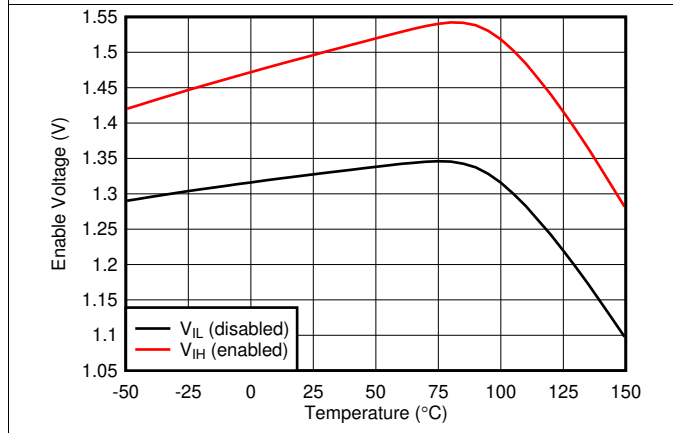

图 17. UVLO vs Ambient Temperature

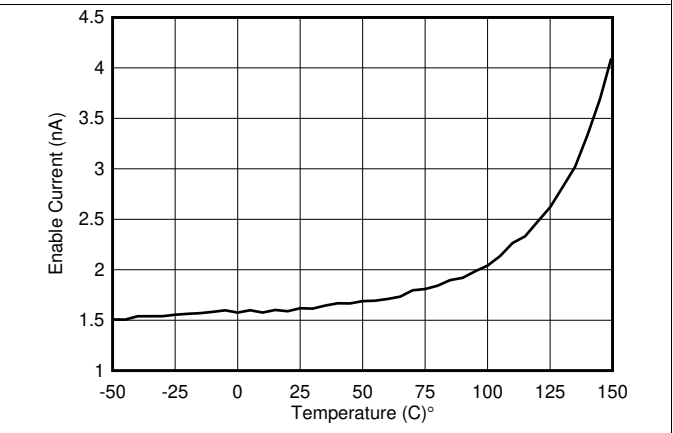

图 18. Startup With Enable

Typical Characteristics (接下页)

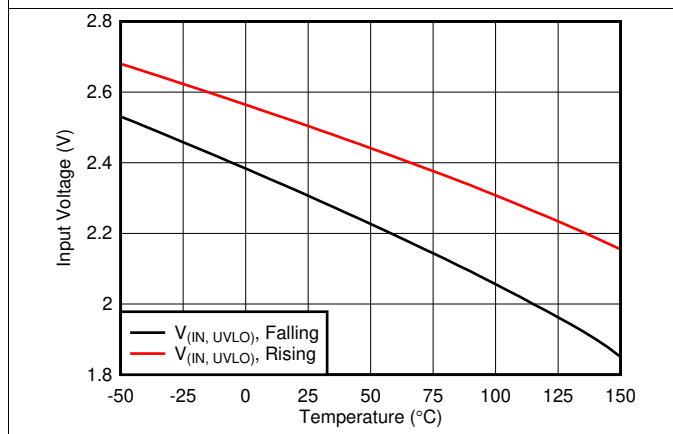
at $T_J = -40^{\circ}\text{C}$ to $+150^{\circ}\text{C}$, $V_{IN} = 14\text{ V}$, and $V_{EN} \geq 2\text{ V}$ (unless otherwise noted)

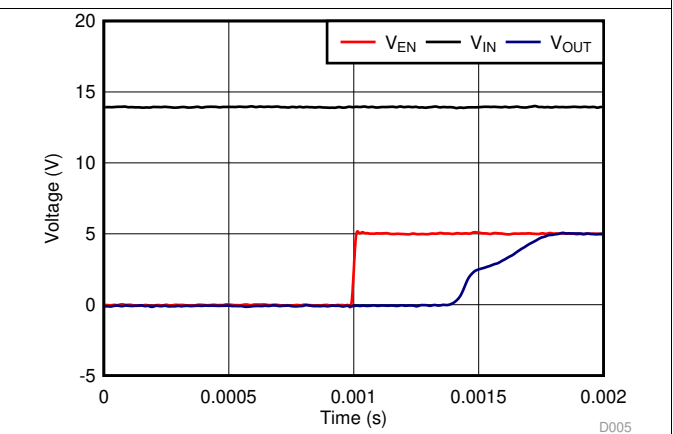
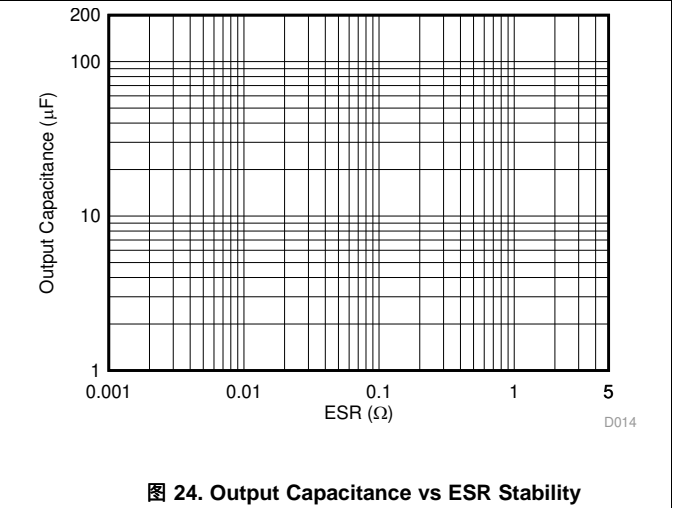
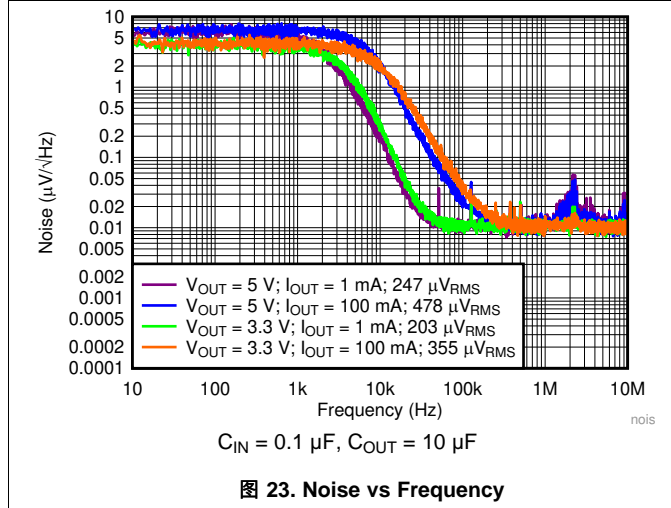
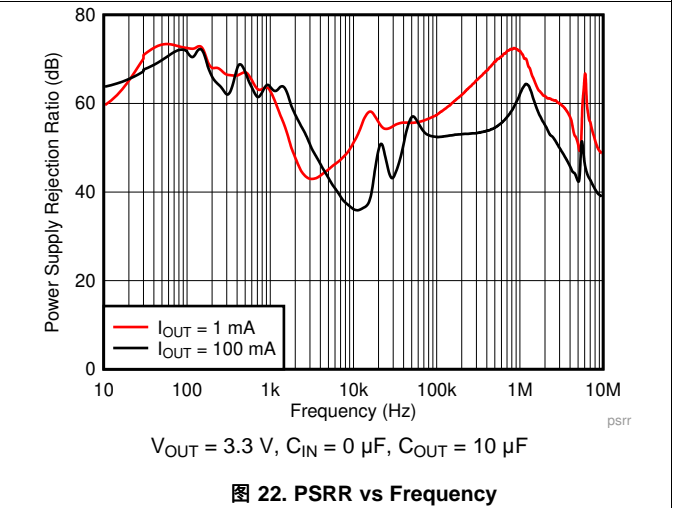
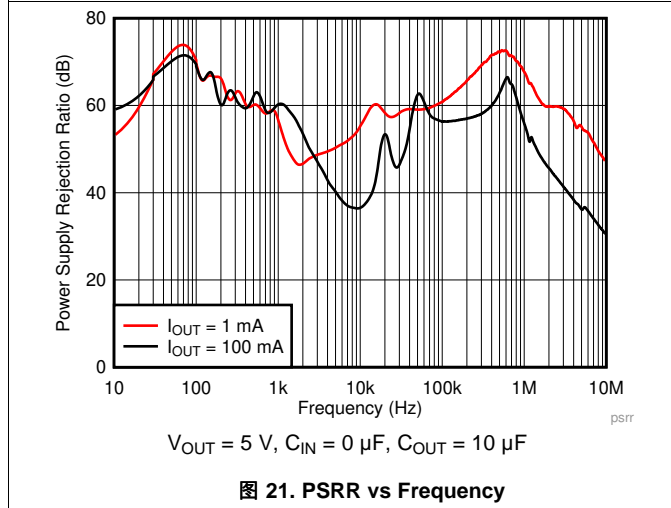
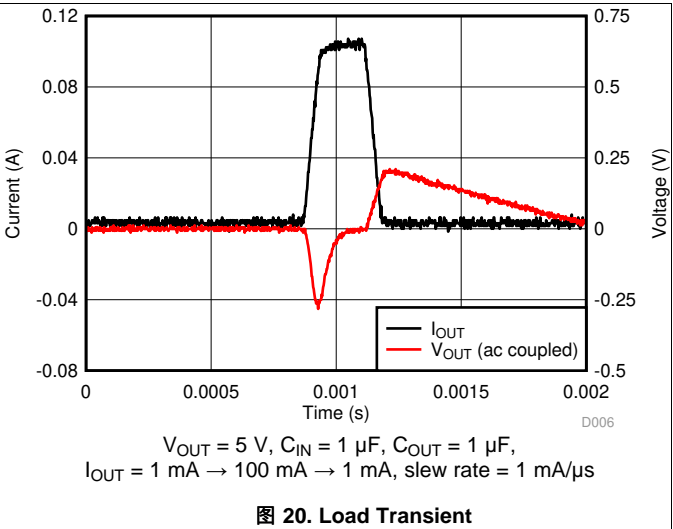
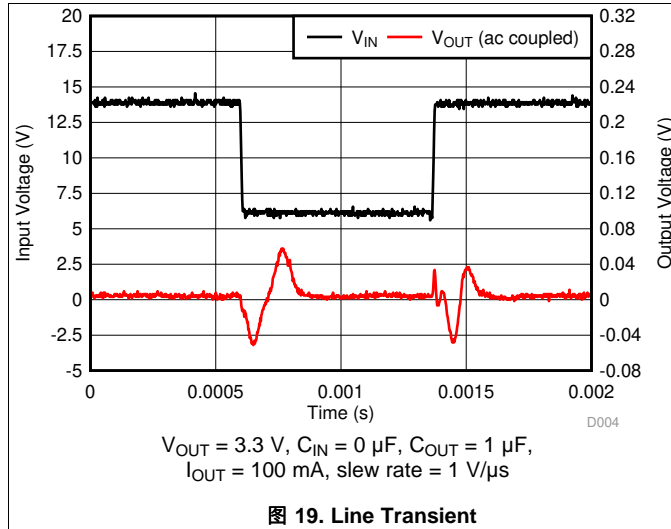

7 Detailed Description

7.1 Overview

The TPS7B81 is a 40-V, 150-mA, low-dropout (LDO) linear regulator with ultra-low quiescent current. This voltage regulator consumes only 3 μ A of quiescent current at light load, and is quite suitable for always-on applications.

7.2 Functional Block Diagram

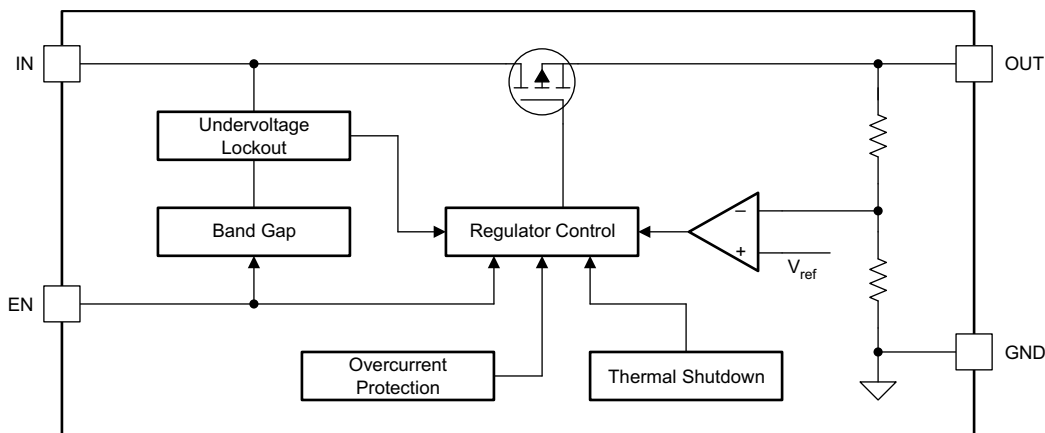

7.3 Feature Description

7.3.1 Device Enable (EN)

The EN pin is a high-voltage-tolerant pin. A high input activates the device and turns the regulation on. Connect this pin to an external microcontroller or a digital circuit to enable and disable the device, or connect to the IN pin for self-bias applications.

7.3.2 Undervoltage Shutdown

This device has an integrated undervoltage lockout (UVLO) circuit to shut down the output if the input voltage (V_{IN}) falls below an internal UVLO threshold ($V_{(UVLO)}$). This feature ensures that the regulator does not latch into an unknown state during low-input-voltage conditions. If the input voltage has a negative transient that drops below the UVLO threshold and recovers, the regulator shuts down and powers up with a normal power-up sequence when the input voltage is above the required level.

7.3.3 Current Limit

This device features current-limit protection to keep the device in a safe operating area when an overload or output short-to-ground condition occurs. This feature protects the device from excessive power dissipation. For example, during a short-circuit condition on the output, the fault protection limits the current through the pass element to $I_{(LIM)}$ to protect the device from excessive power dissipation.

7.3.4 Thermal Shutdown

This device incorporates a thermal shutdown (TSD) circuit as protection from overheating. For continuous normal operation, the junction temperature must not exceed the TSD trip point. If the junction temperature exceeds the TSD trip point, the output turns off. When the junction temperature falls below the TSD trip point minus the thermal shutdown hysteresis, the output turns on again.

7.4 Device Functional Modes

7.4.1 Operation With V_{IN} Lower Than 3 V

The device normally operates with input voltages above 3 V. The device can also operate at lower input voltages; the maximum UVLO voltage is 2.7 V. The device does not operate at input voltages below the actual UVLO voltage.

7.4.2 Operation With V_{IN} Larger Than 3 V

When V_{IN} is greater than 3 V, if V_{IN} is also higher than the output set value plus the device dropout voltage, V_{OUT} is equal to the set value. Otherwise, V_{OUT} is equal to V_{IN} minus the dropout voltage.

表 1. Device Functional Mode Comparison

OPERATING MODE	PARAMETER			
Normal mode	$V_{IN} > V_{OUT(nom)} + V_{(Dropout)}$ and $V_{IN} \geq 3\text{ V}$	$V_{EN} > V_{IH}$	$I_{OUT} < I_{CL}$	$T_J < 160^\circ\text{C}$
Dropout mode	$3\text{ V} \leq V_{IN} < V_{OUT(nom)} + V_{(Dropout)}$	$V_{EN} > V_{IH}$	$I_{OUT} < I_{CL}$	$T_J < 160^\circ\text{C}$
Disabled mode (any true condition disables the device)	$V_{IN} < V_{(IN, UVLO)}$	$V_{EN} < V_{IL}$	—	$T_J > 160^\circ\text{C}$

8 Application and Implementation

注

Information in the following applications sections is not part of the TI component specification, and TI does not warrant its accuracy or completeness. TI's customers are responsible for determining suitability of components for their purposes. Customers should validate and test their design implementation to confirm system functionality.

8.1 Application Information

The TPS7B81 is a 150-mA, 40-V, low-dropout (LDO) linear regulator with ultralow quiescent current. The PSpice transient model is available for download on the [product folder](#) and can be used to evaluate the basic functionality of the device.

8.1.1 Power Dissipation

Circuit reliability demands that proper consideration is given to device power dissipation, location of the circuit on the printed circuit board (PCB), and correct sizing of the thermal plane. The PCB area around the regulator must be as free as possible of other heat-generating devices that cause added thermal stresses.

As a first-order approximation, power dissipation in the regulator depends on the input-to-output voltage difference and load conditions. [公式 1](#) approximates P_D :

$$P_D = (V_{IN} - V_{OUT}) \times I_{OUT} \quad (1)$$

An important note is that power dissipation can be minimized, and thus greater efficiency achieved, by proper selection of the system voltage rails. Proper selection allows the minimum input-to-output voltage differential to be obtained. The low dropout of the device allows for maximum efficiency across a wide range of output voltages.

The main heat conduction path for the device is through the thermal pad on the package. As such, the thermal pad must be soldered to a copper pad area under the device. This pad area contains an array of plated vias that conduct heat to any inner plane areas or to a bottom-side copper plane.

The maximum power dissipation determines the maximum allowable junction temperature (T_J) for the device. According to [公式 2](#), power dissipation and junction temperature are most often related by the junction-to-ambient thermal resistance ($R_{\theta JA}$) of the combined PCB, device package, and the temperature of the ambient air (T_A). This equation is rearranged for output current in [公式 3](#).

$$T_J = T_A + R_{\theta JA} \times P_D \quad (2)$$

$$I_{OUT} = (T_J - T_A) / [R_{\theta JA} \times (V_{IN} - V_{OUT})] \quad (3)$$

Unfortunately, this thermal resistance ($R_{\theta JA}$) is highly dependent on the heat-spreading capability built into the particular PCB design, and therefore varies according to the total copper area, copper weight, and location of the planes. The $R_{\theta JA}$ recorded in the [Thermal Information](#) table is determined by the JEDEC standard, PCB, and copper-spreading area, and is only used as a relative measure of package thermal performance. For a well-designed thermal layout, $R_{\theta JA}$ is actually the sum of the package junction-to-case (bottom) thermal resistance ($R_{\theta JCbot}$) plus the thermal resistance contribution by the PCB copper.

[图 25](#) through [图 28](#) illustrate the functions of $R_{\theta JA}$ and ψ_{JB} versus copper area and thickness. These plots are generated with a 101.6-mm x 101.6-mm x 1.6-mm PCB of two and four layers. For the four-layer board, inner planes use a 1-oz copper thickness. Outer layers are simulated with both 1-oz and 2-oz copper thicknesses. A 2 x 1 array of thermal vias with a 300- μ m drill diameter and a 25- μ m copper (Cu) plating is located beneath the thermal pad of the device. The thermal vias connect the top layer, the bottom layer and, in the case of the 4-layer board, the first inner GND plane. The copper plane of each layer is of an equal area.

Application Information (接下页)



图 25. $R_{\theta JA}$ versus Cu Area for the WSON (DRV) Package



图 26. ψ_{JB} versus Cu Area for the WSON (DRV) Package

Application Information (接下页)

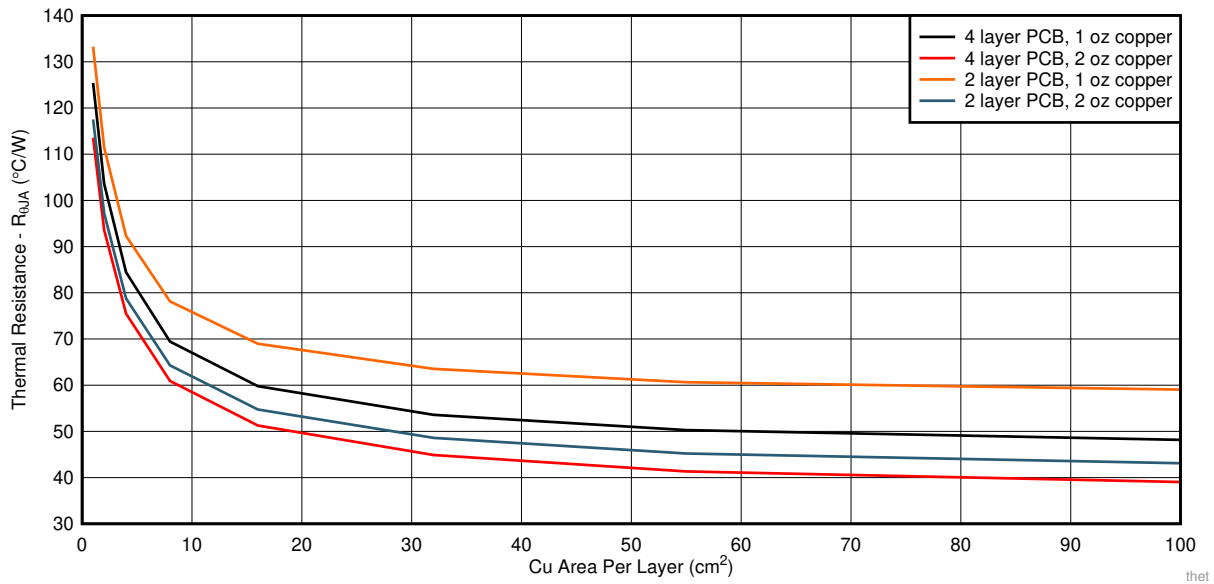

图 27. $R_{\theta JA}$ versus Cu Area for the HVSSOP (DGN) Package

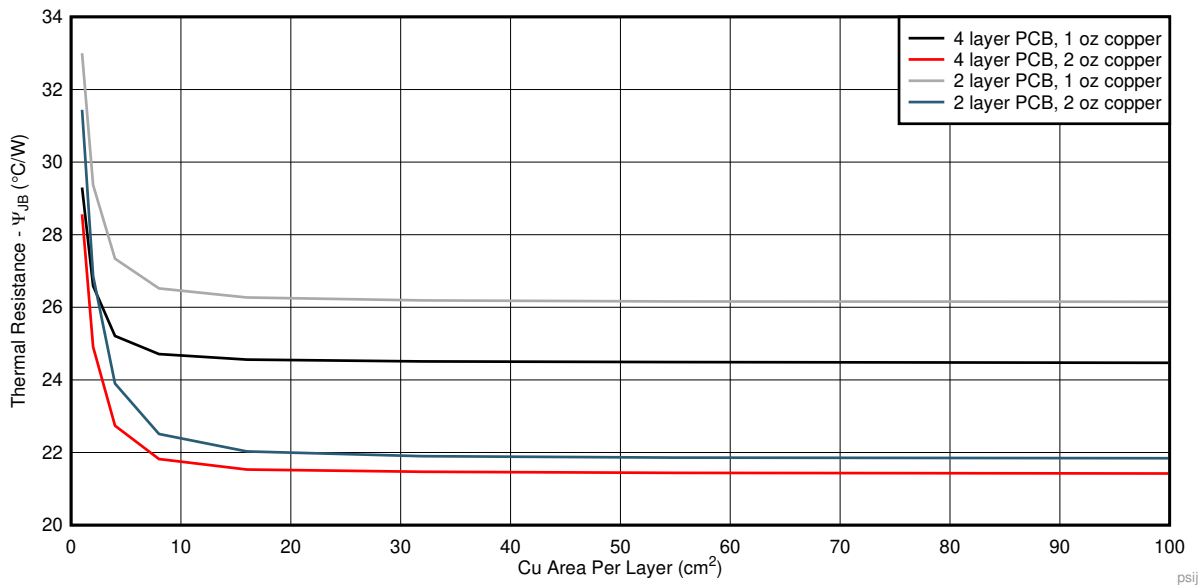

图 28. ψ_{JB} versus Cu Area for the HVSSOP (DGN) Package

Application Information (接下页)

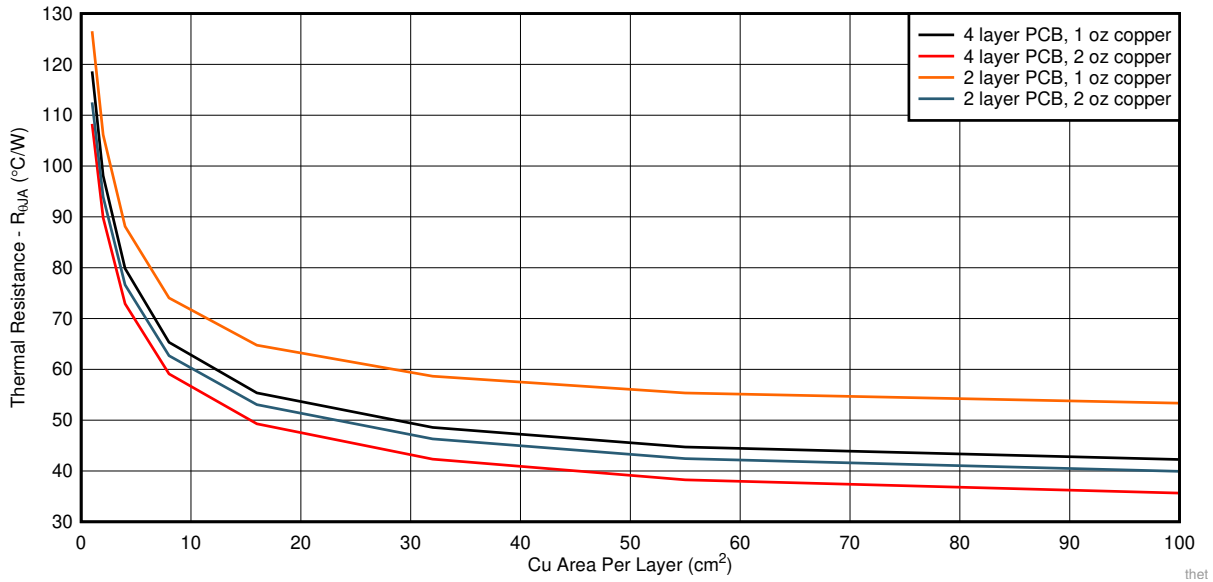
8.1.1.1 Estimating Junction Temperature

The JEDEC standard now recommends the use of psi (Ψ) thermal metrics to estimate the junction temperatures of the LDO when in-circuit on a typical PCB board application. These metrics are not strictly speaking thermal resistance, but rather offer practical and relative means of estimating junction temperatures. These psi metrics are determined to be significantly independent of the copper-spreading area. The key thermal metrics (Ψ_{JT} and Ψ_{JB}) are used in accordance with 公式 4 and given in the [Thermal Information](#) table.

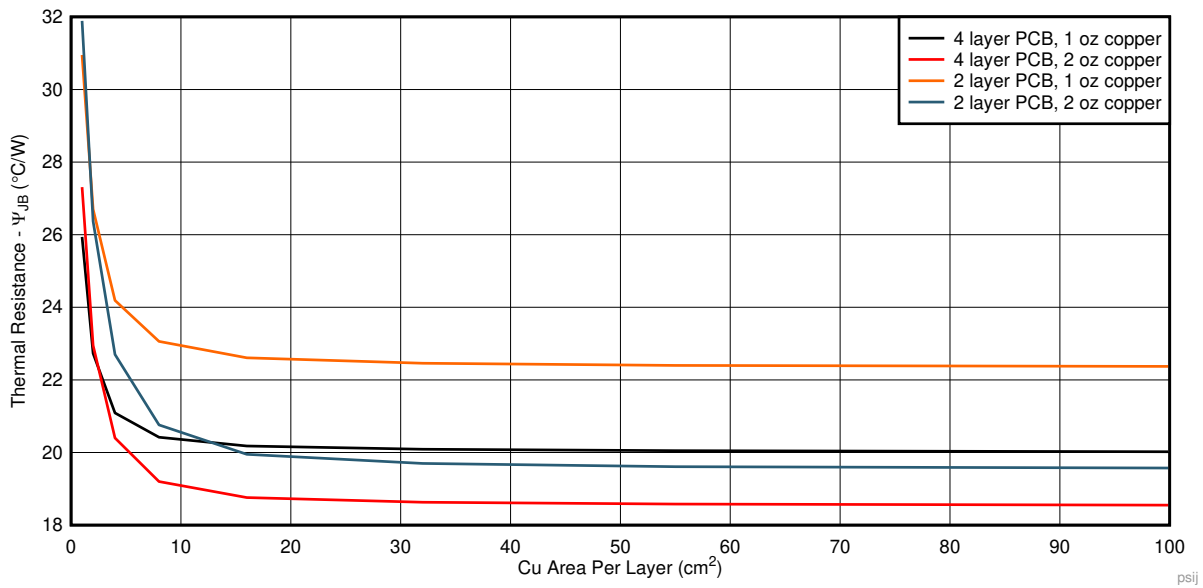
$$\Psi_{JT}: T_J = T_T + \Psi_{JT} \times P_D$$

$$\Psi_{JB}: T_J = T_B + \Psi_{JB} \times P_D$$

where:

- P_D is the power dissipated as explained in 公式 1
- T_T is the temperature at the center-top of the device package
- T_B is the PCB surface temperature measured 1 mm from the device package and centered on the package edge

(4)

8.2 Typical Application

图 29 shows a typical application circuit for the TPS7B81. Different external component values can be used, depending on the end application. An application may require a larger output capacitor during fast load steps to prevent a large drop on the output voltage. TI recommends using a low-equivalent series resistance (ESR) ceramic capacitor with an X5R- or X7R-type dielectric.



图 29. Typical Application Schematic

8.2.1 Design Requirements

Use the parameters listed in 表 2 for this design example.

表 2. Design Requirements Parameters

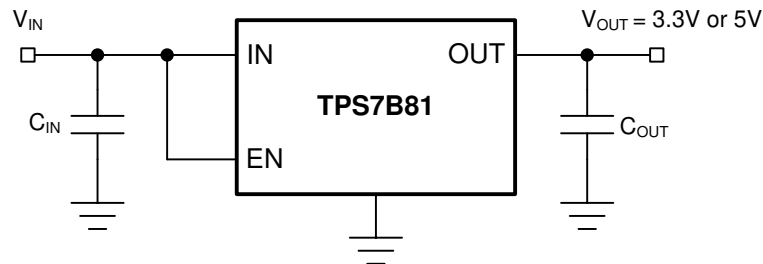
PARAMETER	VALUE
Input voltage range	3 V to 40 V
Output voltage	5 V or 3.3 V
Output current	150 mA maximum

8.2.2 Detailed Design Procedure

To begin the design process, determine the following:

- Input voltage range
- Output voltage
- Output current

8.2.2.1 Input Capacitor

Although an input capacitor is not required for stability, good analog design practice is to connect a 10- μ F to 22- μ F capacitor from IN to GND. This capacitor counteracts reactive input sources and improves transient response, input ripple rejection, and PSRR. The voltage rating must be greater than the maximum input voltage.

8.2.2.2 Output Capacitor

To ensure the stability of the TPS7B81, the device requires an output capacitor with a value in the range from 1 μF to 200 μF and with an ESR range between 0.001 Ω and 5 Ω . TI recommends selecting a ceramic capacitor with low ESR to improve the load transient response.

8.2.3 Application Curve



图 30. Power-Up Waveform (5 V)

9 Power Supply Recommendations

The device is designed to operate from an input voltage supply range from 3 V to 40 V. The input supply must be well regulated. If the input supply is located more than a few inches from the TPS7B81, TI recommends adding a capacitor with a value greater than or equal to 10 μF with a 0.1- μF bypass capacitor in parallel at the input.

10 Layout

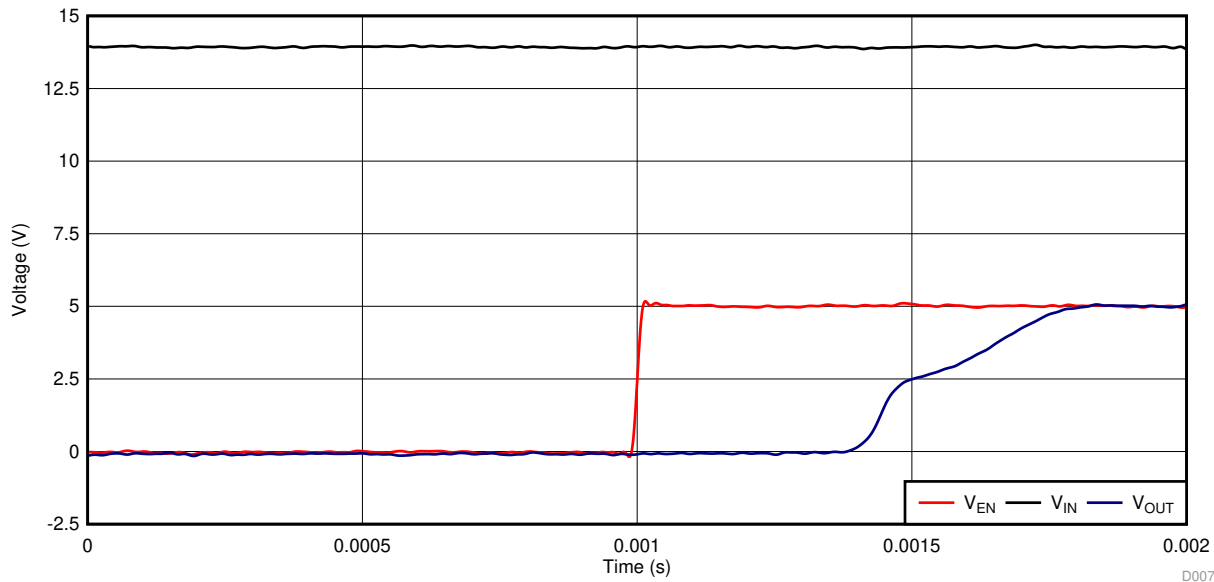
10.1 Layout Guidelines

Layout is an important step for LDO power supplies, especially for high-voltage and large output current supplies. If the layout is not carefully designed, the regulator can fail to deliver enough output current because of thermal limitations. To improve the thermal performance of the device, and to maximize the current output at high ambient temperature, spread the copper under the thermal pad as far as possible and put enough thermal vias on the copper under the thermal pad. 图 31 shows an example layout.

10.2 Layout Example



图 31. Example Layout Diagram

11 器件和文档支持

11.1 接收文档更新通知

要接收文档更新通知，请导航至 ti.com.cn 上的器件产品文件夹。单击右上角的通知我进行注册，即可每周接收产品信息更改摘要。有关更改的详细信息，请查看任何已修订文档中包含的修订历史记录。

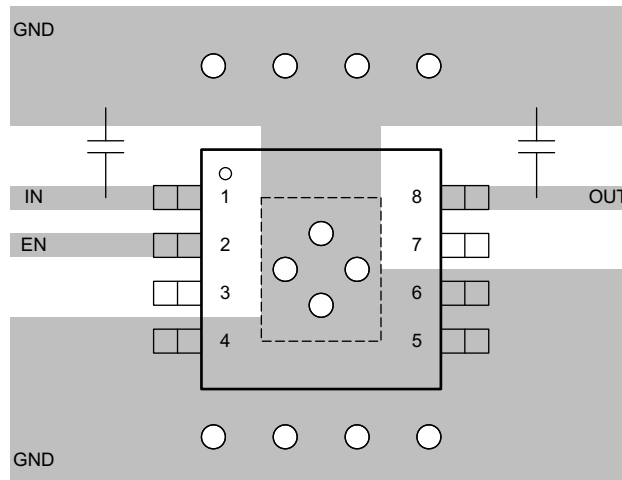
11.2 支持资源

[TI E2E™ support forums](#) are an engineer's go-to source for fast, verified answers and design help — straight from the experts. Search existing answers or ask your own question to get the quick design help you need.

Linked content is provided "AS IS" by the respective contributors. They do not constitute TI specifications and do not necessarily reflect TI's views; see TI's [Terms of Use](#).

11.3 商标

PowerPAD, E2E are trademarks of Texas Instruments.
All other trademarks are the property of their respective owners.

11.4 静电放电警告



ESD 可能会损坏该集成电路。德州仪器 (TI) 建议通过适当的预防措施处理所有集成电路。如果不遵守正确的处理措施和安装程序，可能会损坏集成电路。

ESD 的损坏小至导致微小的性能降级，大至整个器件故障。精密的集成电路可能更容易受到损坏，这是因为非常细微的参数更改都可能会导致器件与其发布的规格不相符。

11.5 Glossary

[SLYZ022](#) — *TI Glossary*.

This glossary lists and explains terms, acronyms, and definitions.

12 机械、封装和可订购信息

以下页面包含机械、封装和可订购信息。这些信息是指定器件的最新可用数据。数据如有变更，恕不另行通知，且不会对此文档进行修订。如需获取此数据表的浏览器版本，请查阅左侧的导航栏。

PACKAGING INFORMATION

Orderable Device	Status (1)	Package Type	Package Drawing	Pins	Package Qty	Eco Plan (2)	Lead finish/ Ball material (6)	MSL Peak Temp (3)	Op Temp (°C)	Device Marking (4/5)	Samples
TPS7B8133DGNR	ACTIVE	HVSSOP	DGN	8	2500	RoHS & Green	NIPDAUAG	Level-2-260C-1 YEAR	-40 to 125	26BX	Samples
TPS7B8133DRVR	ACTIVE	WSON	DRV	6	3000	RoHS & Green	NIPDAU	Level-2-260C-1 YEAR	-40 to 125	26DH	Samples
TPS7B8150DGNR	ACTIVE	HVSSOP	DGN	8	2500	RoHS & Green	NIPDAUAG	Level-2-260C-1 YEAR	-40 to 125	26CX	Samples
TPS7B8150DRVR	ACTIVE	WSON	DRV	6	3000	RoHS & Green	NIPDAU	Level-1-260C-UNLIM	-40 to 125	26EH	Samples

(1) The marketing status values are defined as follows:

ACTIVE: Product device recommended for new designs.

LIFEBUY: TI has announced that the device will be discontinued, and a lifetime-buy period is in effect.

NRND: Not recommended for new designs. Device is in production to support existing customers, but TI does not recommend using this part in a new design.

PREVIEW: Device has been announced but is not in production. Samples may or may not be available.

OBSOLETE: TI has discontinued the production of the device.

(2) **RoHS:** TI defines "RoHS" to mean semiconductor products that are compliant with the current EU RoHS requirements for all 10 RoHS substances, including the requirement that RoHS substance do not exceed 0.1% by weight in homogeneous materials. Where designed to be soldered at high temperatures, "RoHS" products are suitable for use in specified lead-free processes. TI may reference these types of products as "Pb-Free".

RoHS Exempt: TI defines "RoHS Exempt" to mean products that contain lead but are compliant with EU RoHS pursuant to a specific EU RoHS exemption.

Green: TI defines "Green" to mean the content of Chlorine (Cl) and Bromine (Br) based flame retardants meet JS709B low halogen requirements of <=1000ppm threshold. Antimony trioxide based flame retardants must also meet the <=1000ppm threshold requirement.

(3) MSL, Peak Temp. - The Moisture Sensitivity Level rating according to the JEDEC industry standard classifications, and peak solder temperature.

(4) There may be additional marking, which relates to the logo, the lot trace code information, or the environmental category on the device.

(5) Multiple Device Markings will be inside parentheses. Only one Device Marking contained in parentheses and separated by a "-" will appear on a device. If a line is indented then it is a continuation of the previous line and the two combined represent the entire Device Marking for that device.

(6) Lead finish/Ball material - Orderable Devices may have multiple material finish options. Finish options are separated by a vertical ruled line. Lead finish/Ball material values may wrap to two lines if the finish value exceeds the maximum column width.

Important Information and Disclaimer:The information provided on this page represents TI's knowledge and belief as of the date that it is provided. TI bases its knowledge and belief on information provided by third parties, and makes no representation or warranty as to the accuracy of such information. Efforts are underway to better integrate information from third parties. TI has taken and

continues to take reasonable steps to provide representative and accurate information but may not have conducted destructive testing or chemical analysis on incoming materials and chemicals. TI and TI suppliers consider certain information to be proprietary, and thus CAS numbers and other limited information may not be available for release.

In no event shall TI's liability arising out of such information exceed the total purchase price of the TI part(s) at issue in this document sold by TI to Customer on an annual basis.

OTHER QUALIFIED VERSIONS OF TPS7B81 :

- Automotive : [TPS7B81-Q1](#)

NOTE: Qualified Version Definitions:

- Automotive - Q100 devices qualified for high-reliability automotive applications targeting zero defects

GENERIC PACKAGE VIEW

DGN 8

PowerPAD VSSOP - 1.1 mm max height

3 x 3, 0.65 mm pitch

SMALL OUTLINE PACKAGE

This image is a representation of the package family, actual package may vary.
Refer to the product data sheet for package details.

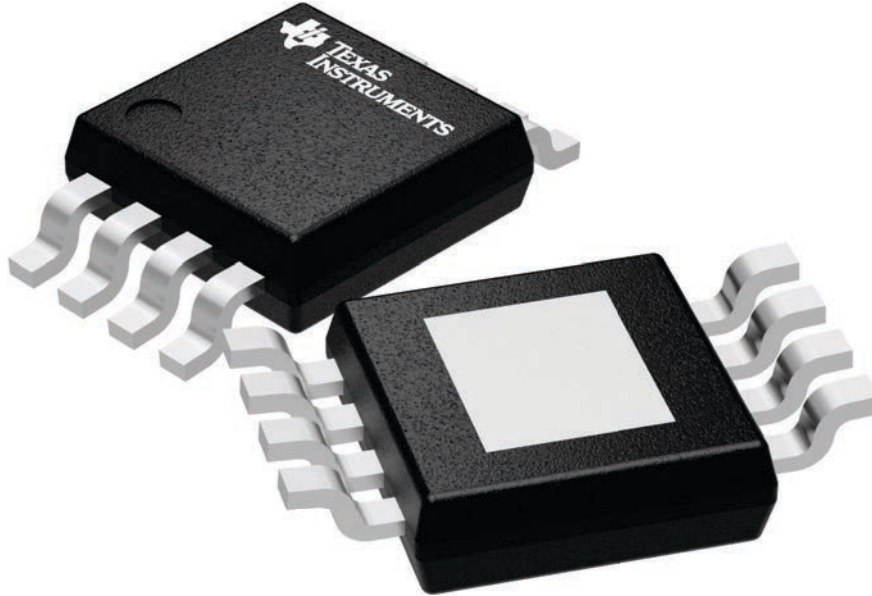

4225482/A

DGN0008G



PACKAGE OUTLINE

PowerPAD™ VSSOP - 1.1 mm max height

SMALL OUTLINE PACKAGE

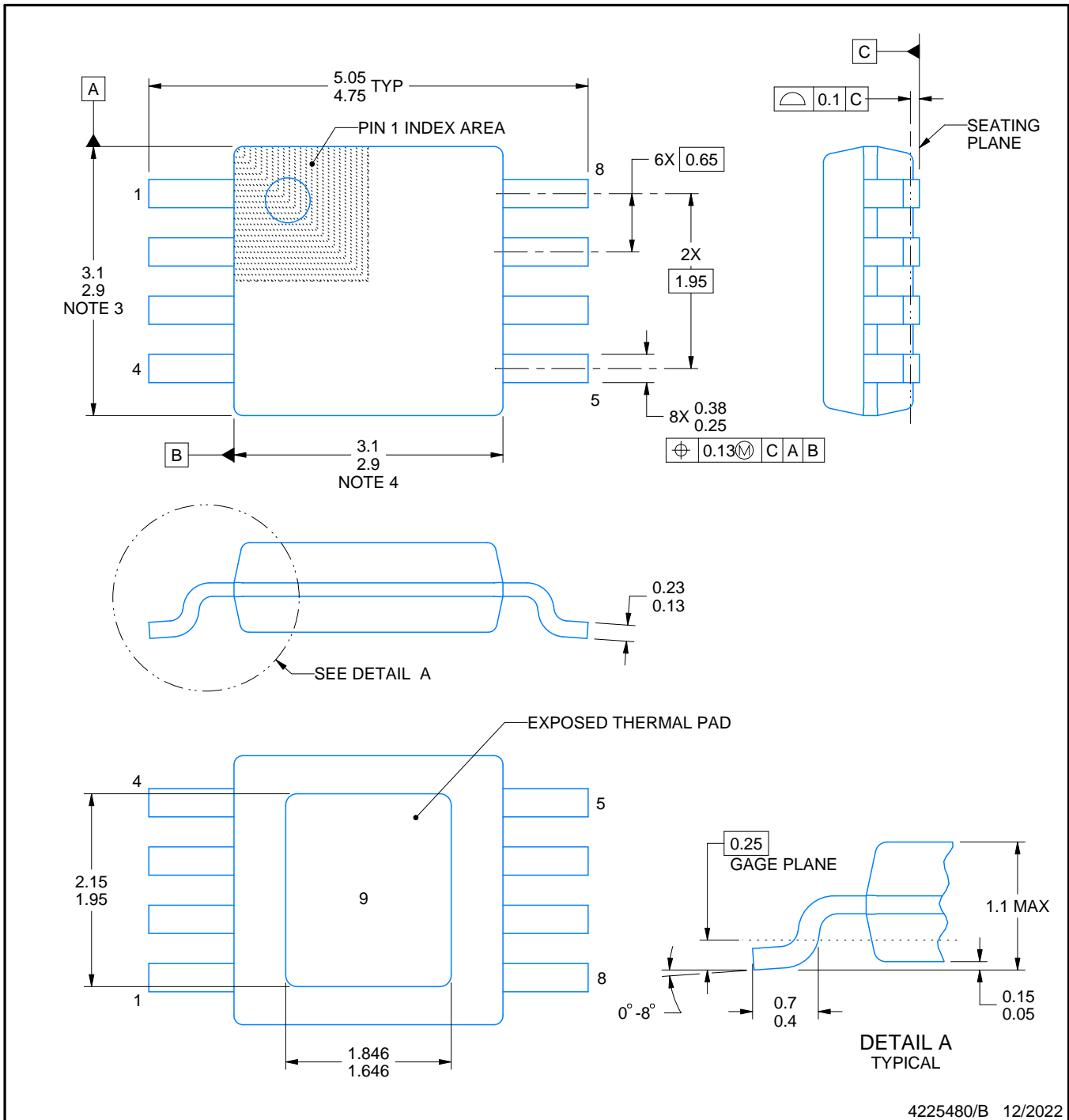

4225480/B 12/2022

PowerPAD is a trademark of Texas Instruments.

NOTES:

1. All linear dimensions are in millimeters. Any dimensions in parenthesis are for reference only. Dimensioning and tolerancing per ASME Y14.5M.
2. This drawing is subject to change without notice.
3. This dimension does not include mold flash, protrusions, or gate burrs. Mold flash, protrusions, or gate burrs shall not exceed 0.15 mm per side.
4. This dimension does not include interlead flash. Interlead flash shall not exceed 0.25 mm per side.
5. Reference JEDEC registration MO-187.

EXAMPLE BOARD LAYOUT

DGN0008G

PowerPAD™ VSSOP - 1.1 mm max height

SMALL OUTLINE PACKAGE

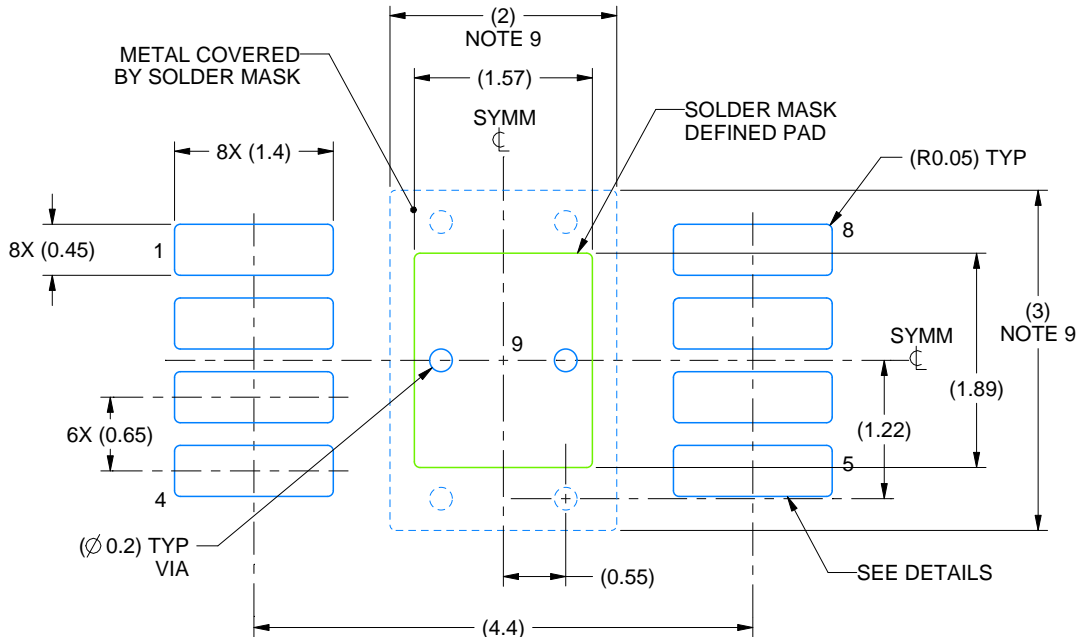

LAND PATTERN EXAMPLE
EXPOSED METAL SHOWN
SCALE: 15X

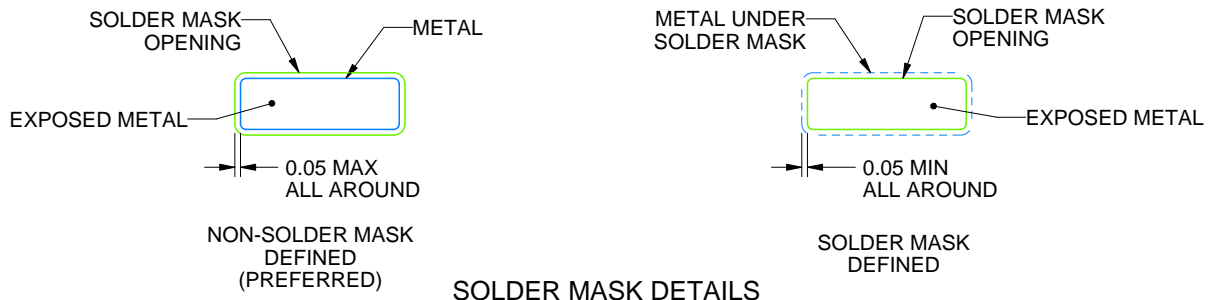

SOLDER MASK DETAILS

4225480/B 12/2022

NOTES: (continued)

6. Publication IPC-7351 may have alternate designs.
7. Solder mask tolerances between and around signal pads can vary based on board fabrication site.
8. Vias are optional depending on application, refer to device data sheet. If any vias are implemented, refer to their locations shown on this view. It is recommended that vias under paste be filled, plugged or tented.
9. Size of metal pad may vary due to creepage requirement.

EXAMPLE STENCIL DESIGN

DGN0008G

PowerPAD™ VSSOP - 1.1 mm max height

SMALL OUTLINE PACKAGE

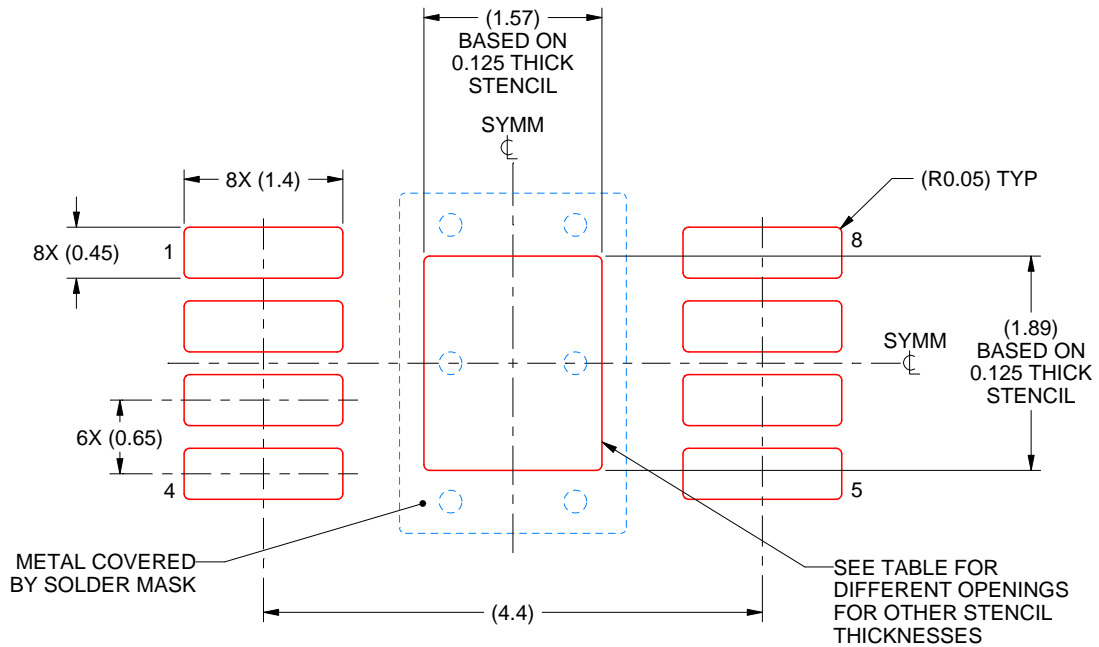

SOLDER PASTE EXAMPLE
EXPOSED PAD 9:
100% PRINTED SOLDER COVERAGE BY AREA
SCALE: 15X

STENCIL THICKNESS	SOLDER STENCIL OPENING
0.1	1.76 X 2.11
0.125	1.57 X 1.89 (SHOWN)
0.15	1.43 X 1.73
0.175	1.33 X 1.60

4225480/B 12/2022

NOTES: (continued)

10. Laser cutting apertures with trapezoidal walls and rounded corners may offer better paste release. IPC-7525 may have alternate design recommendations.
11. Board assembly site may have different recommendations for stencil design.

GENERIC PACKAGE VIEW

DRV 6

WSON - 0.8 mm max height

PLASTIC SMALL OUTLINE - NO LEAD

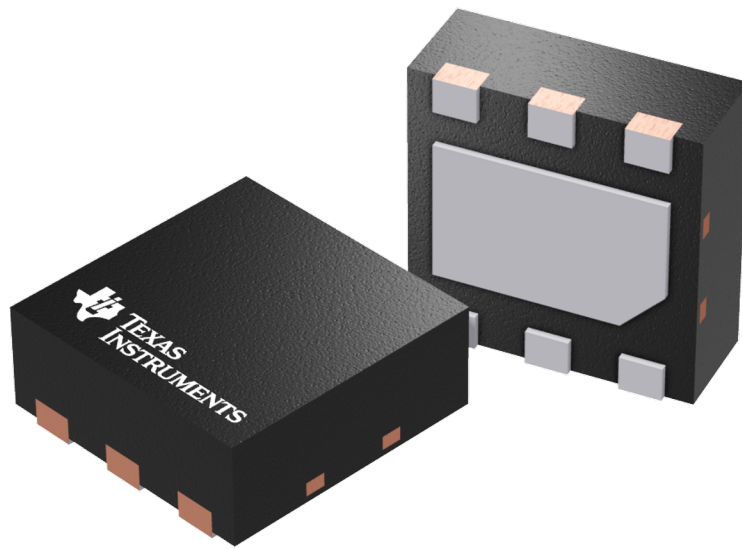

Images above are just a representation of the package family, actual package may vary.
Refer to the product data sheet for package details.

4206925/F

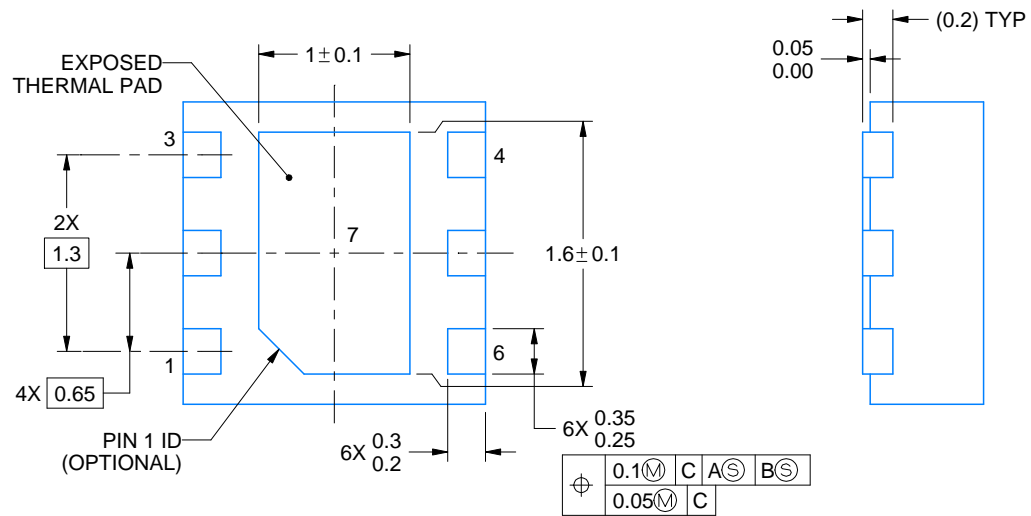
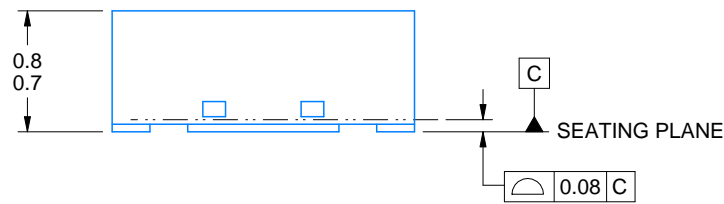
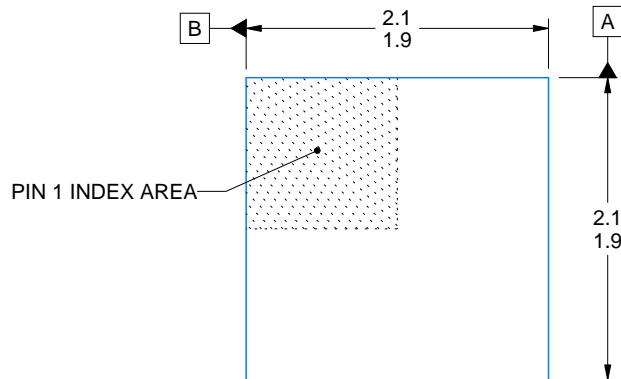
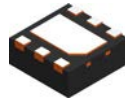

4222173/B 04/2018

NOTES:

1. All linear dimensions are in millimeters. Any dimensions in parenthesis are for reference only. Dimensioning and tolerancing per ASME Y14.5M.
2. This drawing is subject to change without notice.
3. The package thermal pad must be soldered to the printed circuit board for thermal and mechanical performance.

EXAMPLE BOARD LAYOUT

DRV0006A

WSON - 0.8 mm max height

PLASTIC SMALL OUTLINE - NO LEAD

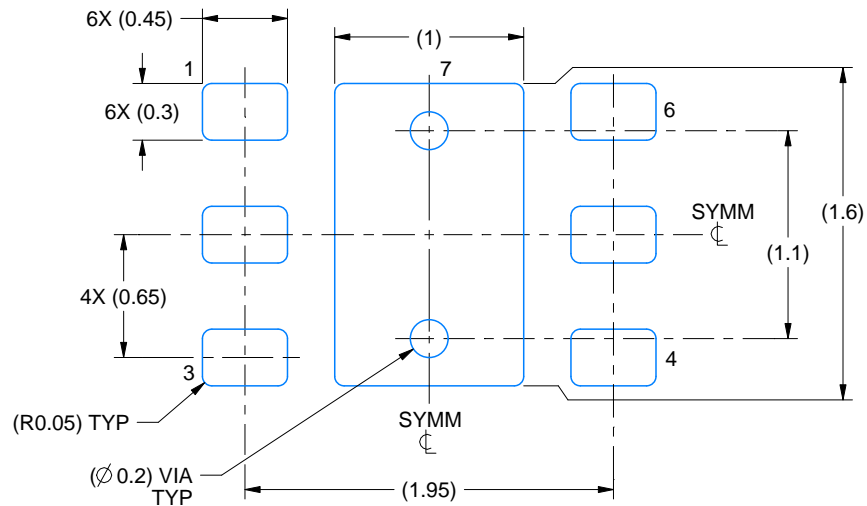

LAND PATTERN EXAMPLE
SCALE:25X

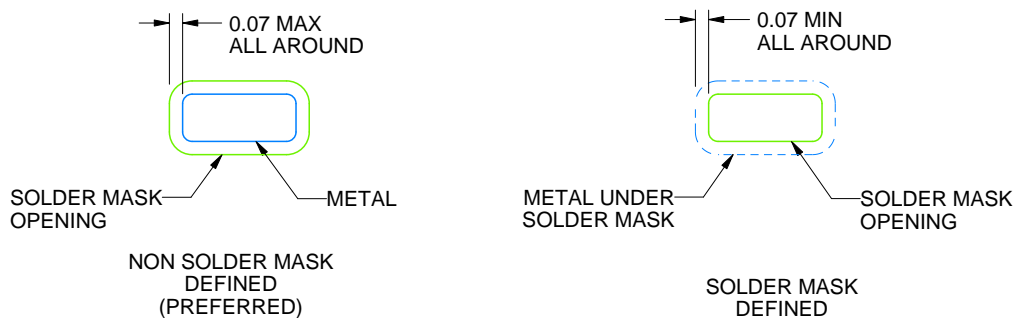

SOLDER MASK DETAILS

4222173/B 04/2018

NOTES: (continued)

4. This package is designed to be soldered to a thermal pad on the board. For more information, see Texas Instruments literature number SLUA271 (www.ti.com/lit/sluea271).
5. Vias are optional depending on application, refer to device data sheet. If some or all are implemented, recommended via locations are shown.

EXAMPLE STENCIL DESIGN

DRV0006A

WSON - 0.8 mm max height

PLASTIC SMALL OUTLINE - NO LEAD

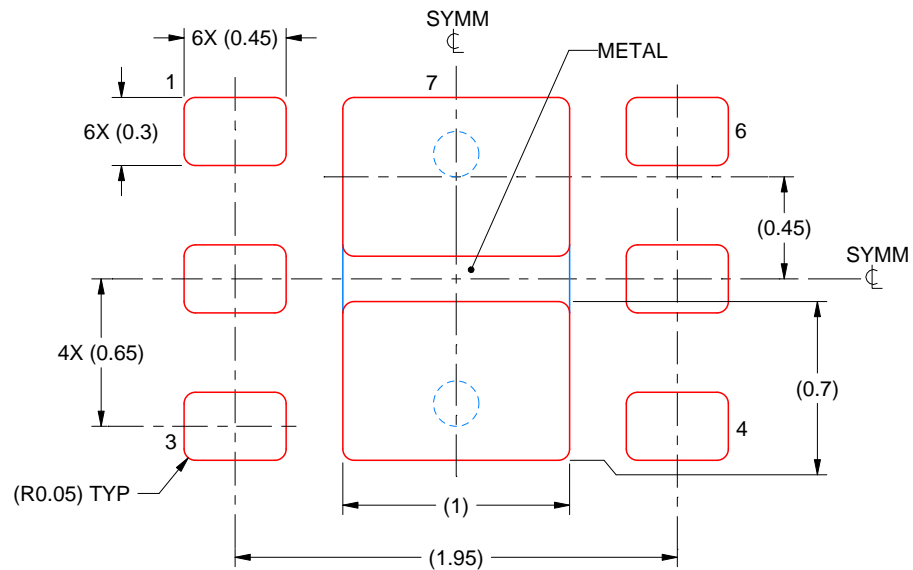

SOLDER PASTE EXAMPLE
BASED ON 0.125 mm THICK STENCIL

EXPOSED PAD #7
88% PRINTED SOLDER COVERAGE BY AREA UNDER PACKAGE
SCALE:30X

4222173/B 04/2018

NOTES: (continued)

6. Laser cutting apertures with trapezoidal walls and rounded corners may offer better paste release. IPC-7525 may have alternate design recommendations.

重要声明和免责声明

TI“按原样”提供技术和可靠性数据（包括数据表）、设计资源（包括参考设计）、应用或其他设计建议、网络工具、安全信息和其他资源，不保证没有瑕疵且不做任何明示或暗示的担保，包括但不限于对适销性、某特定用途方面的适用性或不侵犯任何第三方知识产权的暗示担保。

这些资源可供使用 TI 产品进行设计的熟练开发人员使用。您将自行承担以下全部责任：(1) 针对您的应用选择合适的 TI 产品，(2) 设计、验证并测试您的应用，(3) 确保您的应用满足相应标准以及任何其他功能安全、信息安全、监管或其他要求。

这些资源如有变更，恕不另行通知。TI 授权您仅可将这些资源用于研发本资源所述的 TI 产品的应用。严禁对这些资源进行其他复制或展示。您无权使用任何其他 TI 知识产权或任何第三方知识产权。您应全额赔偿因在这些资源的使用中对 TI 及其代表造成的任何索赔、损害、成本、损失和债务，TI 对此概不负责。

TI 提供的产品受 [TI 的销售条款](#) 或 [ti.com](#) 上其他适用条款/TI 产品随附的其他适用条款的约束。TI 提供这些资源并不会扩展或以其他方式更改 TI 针对 TI 产品发布的适用的担保或担保免责声明。

TI 反对并拒绝您可能提出的任何其他或不同的条款。

邮寄地址：Texas Instruments, Post Office Box 655303, Dallas, Texas 75265

Copyright © 2022，德州仪器 (TI) 公司

X-ON Electronics

Largest Supplier of Electrical and Electronic Components

Click to view similar products for [LDO Voltage Regulators](#) category:

Click to view products by [Texas Instruments](#) manufacturer:

Other Similar products are found below :

[AP7363-SP-13](#) [NCV8664CST33T3G](#) [L79M05TL-E](#) [AP7362-HA-7](#) [PT7M8202B12TA5EX](#) [TCR3DF185,LM\(CT](#) [TLF4949EJ](#)
[NCP4687DH15T1G](#) [NCV8703MX30TCG](#) [LP2951CN](#) [NCV4269CPD50R2G](#) [AP7315-25W5-7](#) [NCV47411PAAJR2G](#) [AP2111H-1.2TRG1](#)
[ZLDO1117QK50TC](#) [AZ1117ID-ADJTRG1](#) [NCV4263-2CPD50R2G](#) [NCP114BMX075TCG](#) [MC33269T-3.5G](#) [TLE4471GXT](#) [AP7315-33SA-](#)
[7](#) [NCV4266-2CST33T3G](#) [NCP715SQ15T2G](#) [NCV8623MN-50R2G](#) [NCV563SQ18T1G](#) [NCV8664CDT33RKG](#) [NCV4299CD250R2G](#)
[NCP715MX30TBG](#) [NCV8702MX25TCG](#) [L974113TR](#) [TLE7270-2E](#) [NCV562SQ25T1G](#) [AP2213D-3.3TRG1](#) [AP2202K-2.6TRE1](#)
[NCV8170BMX300TCG](#) [NCV8152MX300180TCG](#) [NCP700CMT45TBG](#) [AP7315-33W5-7](#) [LD56100DPU28R](#) [NCP154MX180300TAG](#)
[AP2210K-3.0TRE1](#) [AP2113AMTR-G1](#) [NJW4104U2-33A-TE1](#) [MP2013AGG-5-P](#) [NCV8775CDT50RKG](#) [NJM2878F3-45-TE1](#) [S-](#)
[19214B00A-V5T2U7](#) [S-19214B50A-V5T2U7](#) [S-19213B50A-V5T2U7](#) [S-19214BC0A-E8T1U7*1](#)