

采用增强型 Hotrod™ QFN 封装的 TPSM5601R5Hx 60V 输入、1V 至 16V 输出、1.5A 电源模块

1 特性

- 提供功能安全
 - 可帮助进行功能安全系统设计的文档
- 5mm × 5.5mm × 4mm 增强型 HotRod™ QFN
 - 出色的热性能：在 85°C 且无气流的情况下具有高达 18W 的输出功率
 - 标准封装尺寸：单个大型散热焊盘和所有引脚均分布在封装外围
- 专为可靠耐用的应用而设计
 - 宽输入电压范围：4.2V 至 60V
 - 高达 66V 的输入电压瞬态保护
 - 工作结温范围：-40°C 至 +125°C
 - 带 EXT 后缀器件的结温范围：-55°C 至 +125°C
- 固定 1MHz 开关频率
- FPWM 运行模式
- 针对超低 EMI 要求进行了优化
 - 集成屏蔽式电感器和 高频旁路电容器
 - 符合 EN55011 EMI 标准
 - 扩频选项可降低发射
- 26μA 非开关静态电流
- 单调启动至预偏置输出
- 无环路补偿或自举组件
- 具有迟滞功能的精密使能和输入 UVLO
- 具有迟滞功能的热关断保护
- 使用 WEBENCH® Power Designer 创建定制稳压器设计方案

2 应用

- 现场发送器和传感器、PLC 模块
- 恒温器、视频监控、HVAC 系统
- 交流和伺服驱动器、旋转编码器
- 工业运输、资产跟踪
- 负输出应用

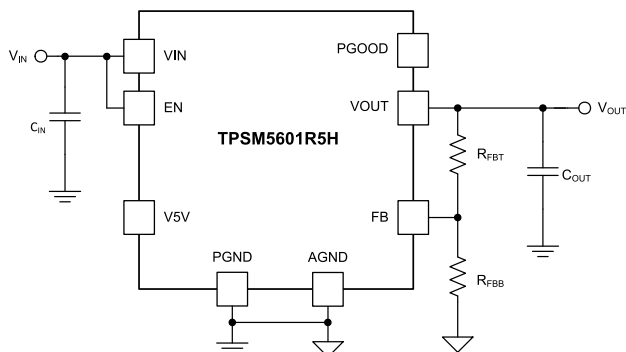

半桥配置

3 说明

TPSM5601R5Hx 电源模块是一款高度集成的 1.5A 电源解决方案，在热增强型 QFN 封装内整合了一个带有功率 MOSFET 的 60V 输入降压直流/直流转换器、一个屏蔽式电感器和多个无源器件。此 5mm × 5.5mm × 4mm、15 引脚 QFN 封装采用增强型 HotRod QFN 技术来实现增强的热性能、小尺寸和低 EMI。该封装体的所有引脚均分布在外围，具有单个大型散热焊盘，可在制造过程中实现简单布局和轻松处理。

TPSM5601R5Hx 是一款紧凑、易用的电源模块，具有 1.0V 至 16V 的可调节宽输出电压范围。总体解决方案仅需四个外部组件，并且省去了设计流程中的环路补偿和磁性元件选择。全套功能集包括电源正常状态指示、可编程 UVLO、预偏置启动、过流和过热保护，因此 TPSM5601R5Hx 成为为各种应用供电的出色器件。空间受限型应用可从 5mm × 5.5mm 封装中受益。此外，TPSM5601R5HEXT 可在 -55°C 的更低温度下运行，TPSM5601R5HS 支持扩频运行。

器件信息

器件型号	封装 ⁽¹⁾	封装尺寸 (标称值)
TPSM5601R5H	QFN (15)	5.0mm × 5.5mm
TPSM5601R5HE		
TPSM5601R5HS		

(1) 如需了解所有可用封装，请参阅数据表末尾的可订购产品附录。

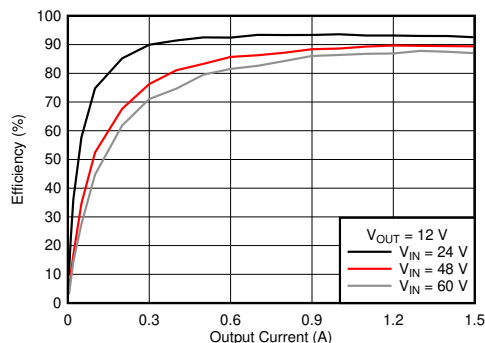

典型效率 (V_{OUT} = 12V)



Table of Contents

1 特性	1	8.3 Feature Description.....	14
2 应用	1	8.4 Device Functional Modes.....	17
3 说明	1	9 Applications and Implementation	18
4 Revision History	2	9.1 Application Information.....	18
5 Device Comparison Table	3	9.2 Typical Application.....	18
6 Pin Configuration and Functions	4	10 Power Supply Recommendations	20
7 Specifications	5	11 Layout	21
7.1 Absolute Maximum Ratings	5	11.1 Layout Guidelines.....	21
7.2 ESD Ratings	5	11.2 Layout Example.....	21
7.3 Recommended Operating Conditions	6	12 Device and Documentation Support	25
7.4 Thermal Information	6	12.1 Device Support.....	25
7.5 Electrical Characteristics	7	12.2 Documentation Support.....	25
7.6 Typical Characteristics (VIN = 12 V).....	9	12.3 Receiving Notification of Documentation Updates..	25
7.7 Typical Characteristics (VIN = 24 V).....	10	12.4 支持资源.....	25
7.8 Typical Characteristics (VIN = 48 V).....	11	12.5 Trademarks.....	25
7.9 Typical Characteristics (VIN = 60 V).....	12	12.6 Electrostatic Discharge Caution.....	26
8 Detailed Description	13	12.7 术语表.....	26
8.1 Overview.....	13	13 Mechanical, Packaging, and Orderable Information	26
8.2 Functional Block Diagram.....	13		

4 Revision History

Changes from Revision A (March 2021) to Revision B (October 2021)	Page
• 添加了功能安全项目符号.....	1

Changes from Revision * (December 2020) to Revision A (March 2021)	Page
• 将器件状态从“预告信息”更改为“量产数据”	1

5 Device Comparison Table

DEVICE	DESCRIPTION
TPSM5601R5H	60-V input voltage, 1-V to 16-V output voltage, 1.5-A power module, fixed 1-MHz switching, operating junction temperature range: - 40°C to +125°C
TPSM5601R5HS	Equivalent to TPSM5601R5H, but with spread spectrum operation
TPSM5601R5HEXT	Equivalent to TPSM5601R5H, but with extended junction temperature range: - 55°C to +125°C

6 Pin Configuration and Functions



图 6-1. 15-Pin QFN RDA Package (Top View)

表 6-1. Pin Functions

PIN		TYPE ⁽¹⁾	DESCRIPTION
NO.	NAME		
10	AGND	G	Analog ground. Zero voltage reference for internal references and logic. All electrical parameters are measured with respect to this pin. This pin must be connected to PGND at a single point. See 节 11.2 for a recommended layout.
5	DNC	—	Do not connect. Do not connect this pin to ground, to another pin, or to any other voltage. This pin is connected to the internal bootstrap capacitor. This pin must be soldered to an isolated pad.
2	EN	I	Enable pin. This pin turns the converter on when pulled high and turns off the converter when pulled low. This pin can be connected directly to VIN. Do not float. This pin can be used to set the input undervoltage lockout with two resistors. See 节 8.3.4.
9	FB	I	Feedback input. Connect the mid-point of the feedback resistor divider to this pin. Connect the upper resistor (R_{FBT}) of the feedback divider to V_{OUT} at the desired point of regulation. Connect the lower resistor (R_{FBB}) of the feedback divider to AGND.
3, 6, 13	NC	—	Not connected. These pins are not connected to any circuitry within the module. Leaving these pins unconnected to any other signal increases spacing near the high voltage pins (VIN, SW, EN, DNC). However, if the high voltage spacing is not needed in the application, connecting these pins to the PGND plane can help to enhance shielding and thermal performance.
15	PGND	G	Power ground. This is the return current path for the power stage of the device. Connect this pad to the input supply return, load return, and capacitors associated with the VIN and VOUT pins. See 节 11.2 for a recommended layout.
12	PGOOD	O	Power-good pin. Open-drain output that asserts low if the feedback voltage is not within the specified window thresholds. A 10-k Ω to 100-k Ω pullup resistor is required and can be tied to the V5V pin or other DC voltage less than 18 V. If not used, this pin can be left open or connected to PGND.
4	SW	O	Switch node. Do not place any external component on this pin or connect to any signal.
1, 14	VIN	I	Input supply voltage. Connect the input supply to these pins. Connect input capacitors between these pins and PGND in close proximity to the device.
7, 8	VOUT	O	Output voltage. These pins are connected to the internal output inductor. Connect these pins to the output load and connect external output capacitors between these pins and PGND.
11	V5V	O	Internal 5-V LDO output. Supplies internal control circuits. Do not connect to external loads. This pin can be used as logic supply for PGOOD pin.

(1) G = Ground, I = Input, O = Output

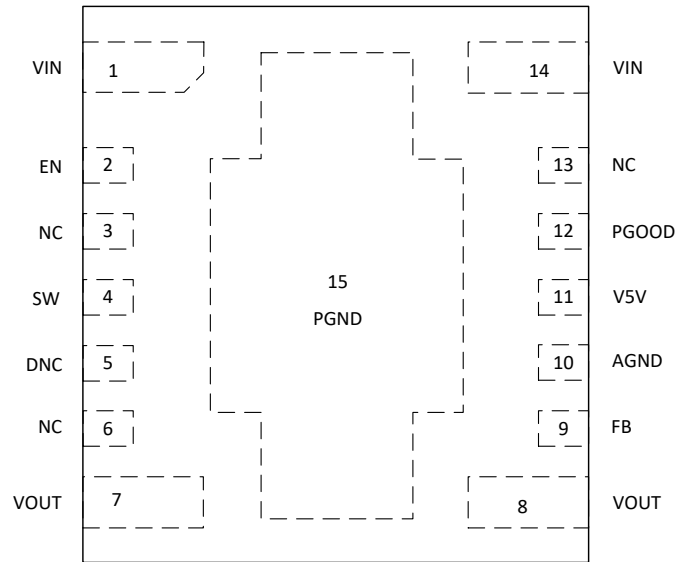
7 Specifications

7.1 Absolute Maximum Ratings

Over the operating ambient temperature range⁽¹⁾

PARAMETER		MIN	MAX	UNIT
Input voltage	VIN to PGND	- 0.3	66	V
	EN to AGND ⁽²⁾	- 0.3	V _{IN} + 0.3	
	PGOOD to AGND ⁽²⁾	- 0.3	22	
	FB to AGND	- 0.3	5.5	
	AGND to PGND	- 0.3	0.3	
Output voltage	VOUT to PGND ⁽²⁾	- 0.3	30	V
	VCC to AGND	0	5.5	
Operating IC junction temperature, T _J ⁽³⁾	Non-EXT suffix device	- 40	125	°C
	EXT suffix device	- 55	125	°C
Storage temperature, T _{stg}		- 55	150	°C
Peak reflow case temperature			245	°C
Maximum number of reflows allowed			3	
Mechanical vibration	Mil-STD-883H, Method 2007.3, 1 msec, 1/2 sine, mounted		20	G
Mechanical shock	Mil-STD-883H, Method 2002.5, 20 to 2000Hz		500	G

- (1) Stresses beyond those listed under *Absolute Maximum Ratings* may cause permanent damage to the device. These are stress ratings only, which do not imply functional operation of the device at these or any conditions beyond those indicated in *Recommended Operating Conditions*. Exposure to absolute-maximum-rated conditions for extended periods may affect device reliability.
- (2) The voltage on this pin must not exceed the voltage on the VIN pin by more than 0.3 V
- (3) The ambient temperature is the air temperature of the surrounding environment. The junction temperature is the temperature of the internal power IC when the device is powered. Operating below the maximum ambient temperature, as shown in the safe operating area (SOA) curves in the typical characteristics sections, ensures that the maximum junction temperature of any component inside the module is never exceeded.

7.2 ESD Ratings

			VALUE	UNIT
V _(ESD)	Electrostatic discharge	Human-body model (HBM) ⁽¹⁾	±1500	V
		Charged-device model (CDM) ⁽²⁾	±1500	

- (1) JEDEC document JEP155 states that 500-V HBM allows safe manufacturing with a standard ESD control process.
- (2) JEDEC document JEP157 states that 250-V CDM allows safe manufacturing with a standard ESD control process.

7.3 Recommended Operating Conditions

Over operating ambient temperature range (unless otherwise noted) ⁽¹⁾

		MIN	MAX	UNIT
Input voltage, V_{IN}		4.2	60	V
Output voltage, V_{OUT}		1	16 ⁽³⁾	V
Output current, I_{OUT}		0	1.5	A
EN voltage, V_{EN} ⁽²⁾		0	V_{IN}	V
PGOOD pullup voltage, V_{PGOOD} ⁽²⁾		0	18	V
Operating ambient temperature, T_A	Non-EXT suffix device	-40	105	°C
	EXT suffix device	-55	105	°C

- (1) Recommended operating conditions indicate conditions for which the device is intended to be functional, but do not ensure specific performance limits. For ensured specifications, see [§ 7.5](#).
- (2) The voltage on this pin must not exceed the voltage on the V_{IN} pin by more than 0.3 V.
- (3) The recommended maximum output voltage varies depending input voltage.

7.4 Thermal Information

THERMAL METRIC ⁽¹⁾			TPSM5601R5Hx	UNIT
			RDA (QFN)	
			15 PINS	
$R_{\theta JA}$	Junction-to-ambient thermal resistance ⁽²⁾	Nat Conv	20.4	°C/W
		100 LFM	18.9	°C/W
		200 LFM	17.6	°C/W
ψ_{JT}	Junction-to-top characterization parameter ⁽³⁾		3.6	°C/W
ψ_{JB}	Junction-to-board characterization parameter ⁽⁴⁾		15.3	°C/W
T_{SHDN}	Thermal shutdown temperature		170	°C
	Recovery temperature		158	°C

- (1) For more information about traditional and new thermal metrics, see the [Semiconductor and IC Package Thermal Metrics](#) app-note.
- (2) The junction-to-ambient thermal resistance, $R_{\theta JA}$, applies to devices soldered directly to a 6.35 cm × 8.25 cm, four-layer PCB with 2-oz. copper. Additional airflow and PCB copper area reduces $R_{\theta JA}$. See [§ 11.2.1](#) for more information.
- (3) The junction-to-top board characterization parameter, ψ_{JT} , estimates the junction temperature, T_J , of a device in a real system, using a procedure described in JESD51-2A (section 6 and 7). $T_J = \psi_{JT} \times P_{dis} + T_T$; where P_{dis} is the power dissipated in the device and T_T is the temperature of the top of the device.
- (4) The junction-to-board characterization parameter, ψ_{JB} , estimates the junction temperature, T_J , of a device in a real system, using a procedure described in JESD51-2A (sections 6 and 7). $T_J = \psi_{JB} \times P_{dis} + T_B$; where P_{dis} is the power dissipated in the device and T_B is the temperature of the board 1mm from the device.

7.5 Electrical Characteristics

Limits apply over $T_A = -40^{\circ}\text{C}$ to $+105^{\circ}\text{C}$ (EXT suffix device; $T_A = -55^{\circ}\text{C}$ to $+105^{\circ}\text{C}$), $V_{IN} = 24\text{ V}$, $V_{OUT} = 3.3\text{ V}$, $I_{OUT} = 1.5\text{ A}$, (unless otherwise noted); Minimum and maximum limits are specified through production test or by design. Typical values represent the most likely parametric norm and are provided for reference only.

PARAMETER		TEST CONDITIONS	MIN	TYP	MAX	UNIT
INPUT VOLTAGE (V_{IN})						
V_{IN}	Input voltage range	Over I_{OUT} range	4.2 ⁽¹⁾		60	V
	V_{IN} turn on	V_{IN} increasing, $I_{OUT} = 0\text{ A}$, $V_{EN} = V_{IN}$		3.8		V
	V_{IN} turn off	V_{IN} decreasing, $I_{OUT} = 0\text{ A}$, $V_{EN} = V_{IN}$		3.3		V
I_{SHDN}	Shutdown supply current	$V_{EN} = 0\text{ V}$, $I_{OUT} = 0\text{ A}$		5		μA
INTERNAL LDO (V_{CC})						
V_{CC}	Internal LDO output voltage appearing at the V_{CC} pin	$6\text{ V} \leq V_{IN} \leq 60\text{ V}$	4.75	5	5.25	V
FEEDBACK						
V_{FB}	Feedback voltage ⁽²⁾	$I_{OUT} = 0\text{ A}$	0.985	1	1.015	V
	Load regulation	$T_A = +25^{\circ}\text{C}$, $0\text{ A} \leq I_{OUT} \leq 1.5\text{ A}$		0.057		%
	Line regulation	$T_A = +25^{\circ}\text{C}$, $I_{OUT} = 0\text{ A}$, $6\text{ V} \leq V_{IN} \leq 60\text{ V}$		0.024		%
I_{FB}	Current into FB pin	$FB = 1\text{ V}$		0.2		nA
CURRENT						
I_{OUT}	Output current	$T_A = 25^{\circ}\text{C}$	0		1.5	A
I_{OUT}	Overcurrent threshold	$V_{OUT} = 3.3\text{ V}$, $T_A = 25^{\circ}\text{C}$		1.9		A
V_{HC}	FB pin voltage required to trip short-circuit hiccup mode			0.4		V
t_{HC}	Time between current-limit hiccup burst			94		ms
ENABLE (EN PIN)						
$V_{EN-VCC-H}$	EN input level required to turn on internal LDO	Rising threshold			1.14	V
$V_{EN-VCC-L}$	EN input level required to turn off internal LDO	Falling threshold	0.3			V
V_{EN-H}	EN input level required to start switching	Rising threshold	1.157	1.231	1.30	V
V_{EN-HYS}	Hysteresis below V_{EN-H}	Hysteresis below V_{EN-H} ; falling		110		mV
I_{LKG-EN}	Enable input leakage current	$V_{EN} = 3.3\text{ V}$		0.2		nA
POWER GOOD (PGOOD PIN)						
$V_{PG-LOW-UP}$	V_{OUT} rising (fault)	% of FB voltage		107%		
$V_{PG-HIGH-DN}$	V_{OUT} falling (good)	% of FB voltage		105%		
$V_{PG-HIGH-UP}$	V_{OUT} rising (good)	% of FB voltage		95%		
$V_{PG-LOW-DN}$	V_{OUT} falling (fault)	% of FB voltage		93%		
R_{PG}	Power-good flag R_{DSON}	$V_{EN} = 0\text{ V}$		35		Ω
V_{IN-PG}	Minimum input voltage for proper PGOOD function	$I_{PG} = 50\text{ }\mu\text{A}$, $EN = 0\text{ V}$			2	V

7.5 Electrical Characteristics (continued)

Limits apply over $T_A = -40^{\circ}\text{C}$ to $+105^{\circ}\text{C}$ (EXT suffix device; $T_A = -55^{\circ}\text{C}$ to $+105^{\circ}\text{C}$), $V_{IN} = 24\text{ V}$, $V_{OUT} = 3.3\text{ V}$, $I_{OUT} = 1.5\text{ A}$, (unless otherwise noted); Minimum and maximum limits are specified through production test or by design. Typical values represent the most likely parametric norm and are provided for reference only.

PARAMETER		TEST CONDITIONS	MIN	TYP	MAX	UNIT
PERFORMANCE						
η	Efficiency	$V_{OUT} = 3.3\text{ V}$, $I_{OUT} = 0.75\text{ A}$, $T_A = 25^{\circ}\text{C}$		81%		
η	Efficiency	$V_{OUT} = 5.0\text{ V}$, $I_{OUT} = 0.75\text{ A}$, $T_A = 25^{\circ}\text{C}$		86%		
SOFT START						
t_{SS}	Internal soft-start time			4.5		ms
SWITCHING FREQUENCY						
f_{SW}	Switching frequency	$I_{OUT} = 0.75\text{ A}$, $T_A = 25^{\circ}\text{C}$	0.85	1 ⁽³⁾	1.15	MHz
f_{SW} ss device	Switching frequency for spread spectrum device only	$I_{OUT} = 0.75\text{ A}$, $T_A = 25^{\circ}\text{C}$	0.80	1	1.20	MHz

- (1) The recommended minimum V_{IN} is 4.2 V or ($V_{OUT} + 600\text{ mV}$), whichever is greater.
- (2) The overall output voltage tolerance is affected by the tolerance of the external R_{FBT} and R_{FBB} resistors.
- (3) The typical switching frequency of this device will change based on operating conditions. See the Switching Frequency section for more information.

7.6 Typical Characteristics (VIN = 12 V)

T_A = 25°C, unless otherwise noted.



图 7-1. Efficiency



图 7-2. Power Dissipation

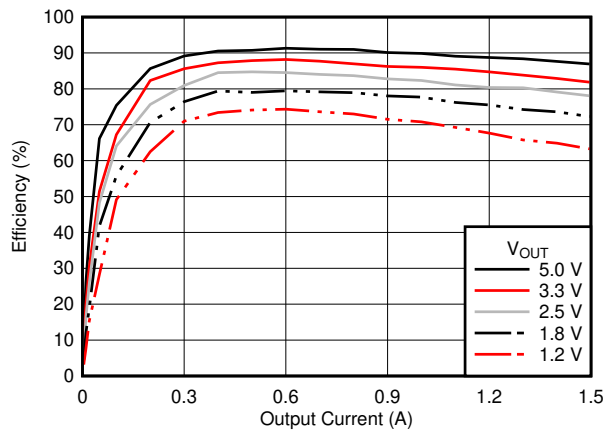

图 7-3. Output Voltage Ripple

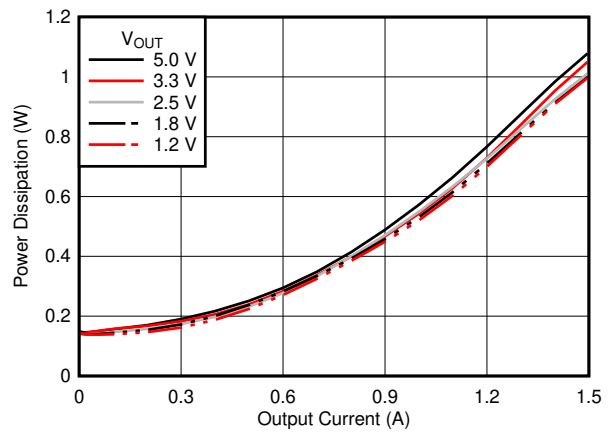

图 7-4. Safe Operating Area (V_{OUT} = 1.2 V)

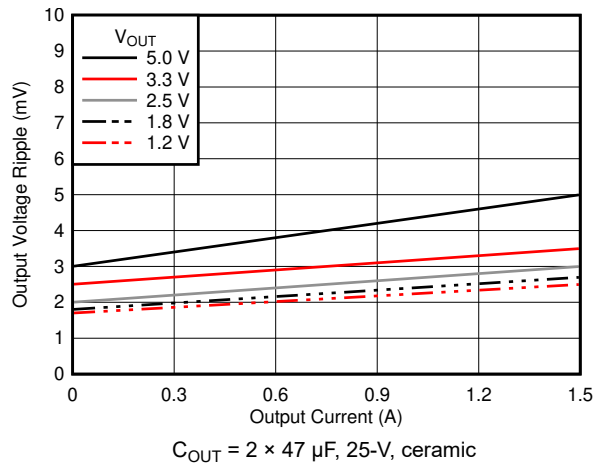

图 7-5. Safe Operating Area (V_{OUT} = 3.3 V)

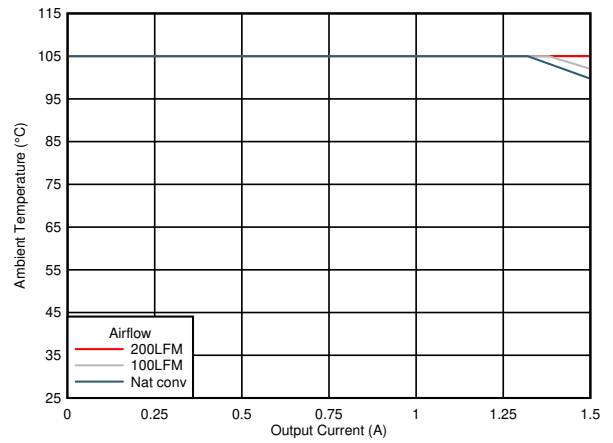

图 7-6. Safe Operating Area (V_{OUT} = 5.0 V)

7.7 Typical Characteristics (VIN = 24 V)

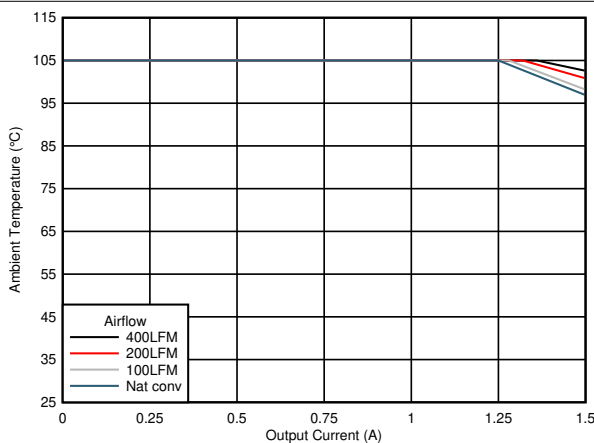
T_A = 25°C, unless otherwise noted.

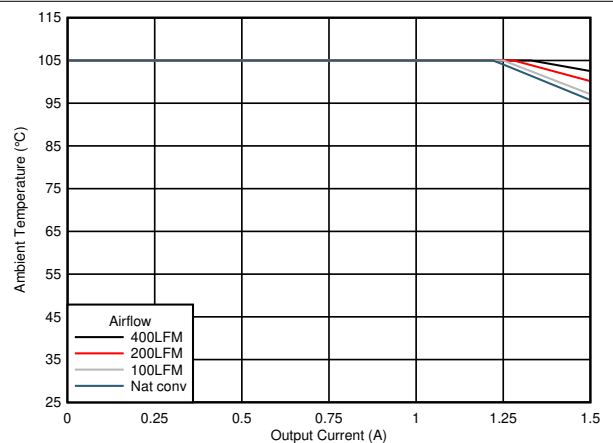
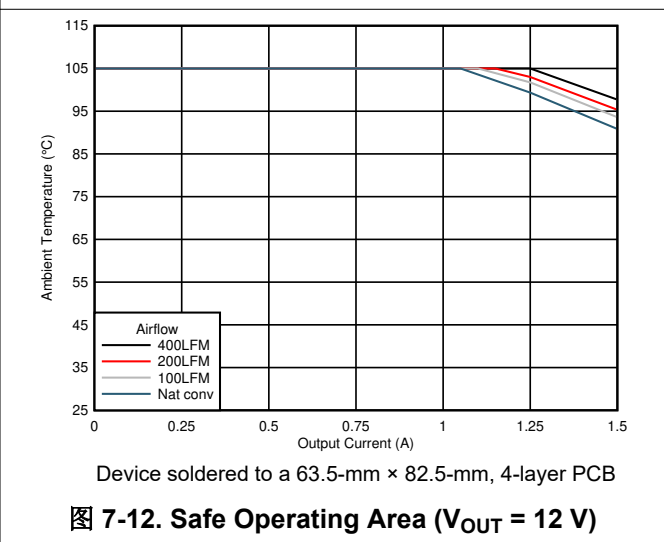
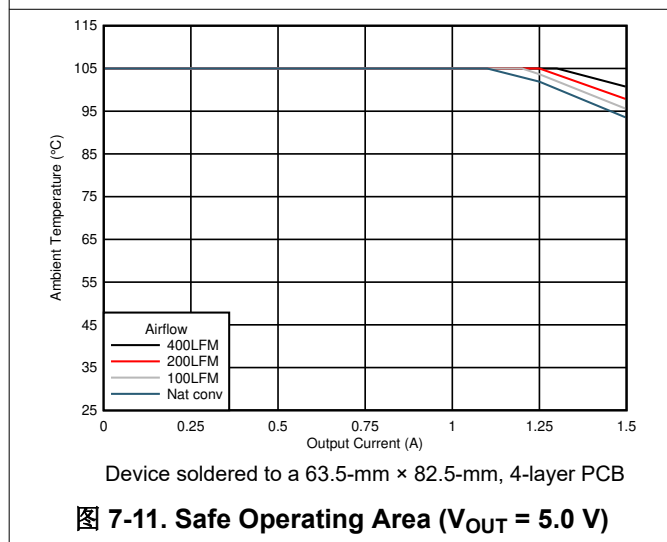
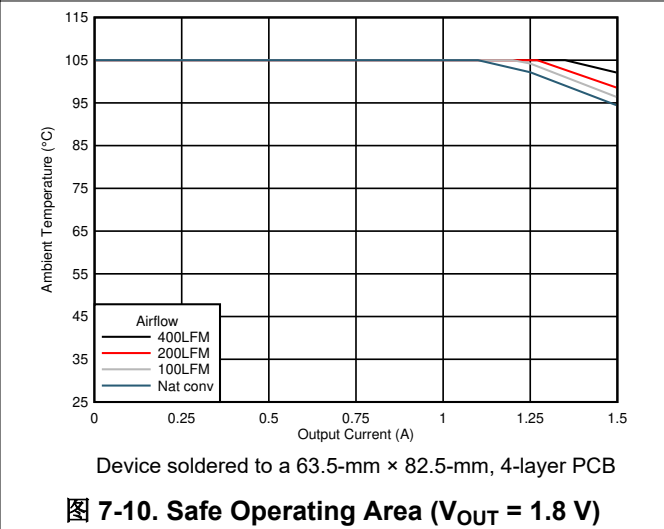
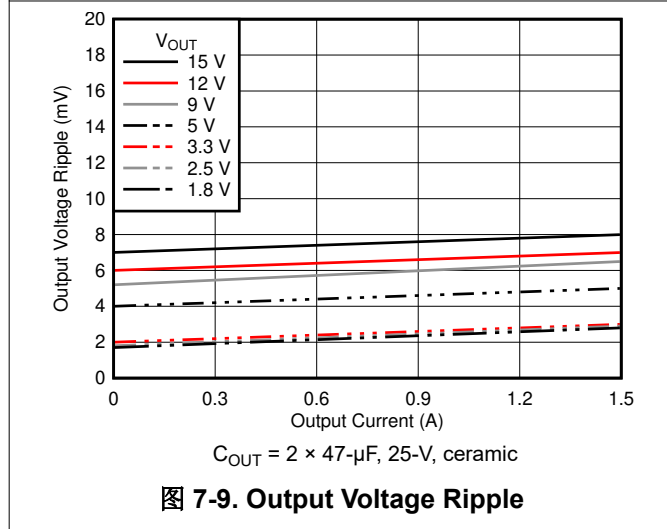
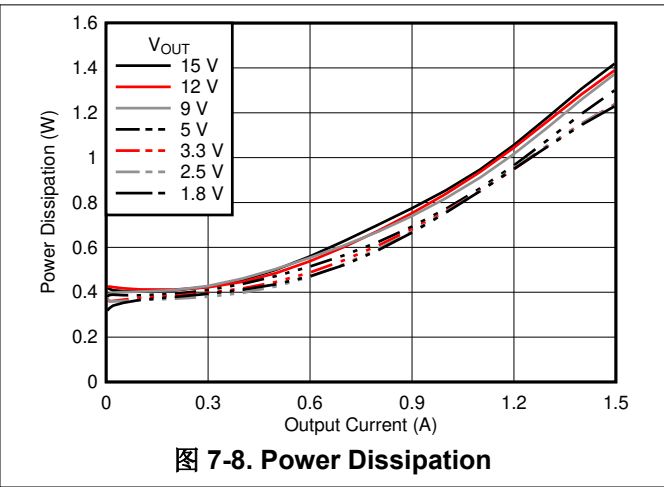
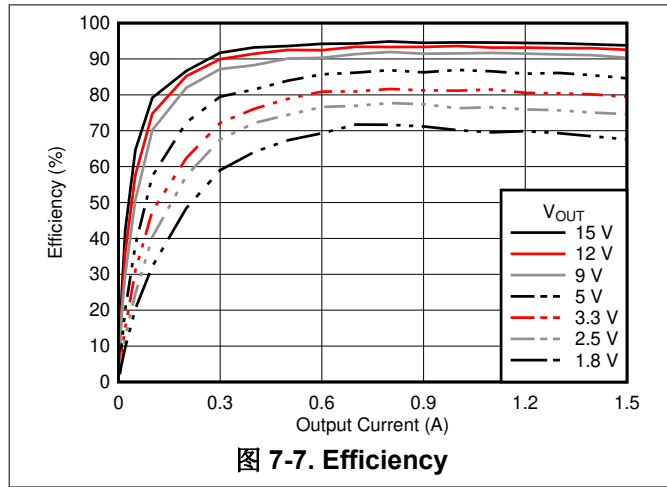

7.8 Typical Characteristics (VIN = 48 V)

T_A = 25°C, unless otherwise noted.



图 7-13. Efficiency



图 7-14. Power Dissipation

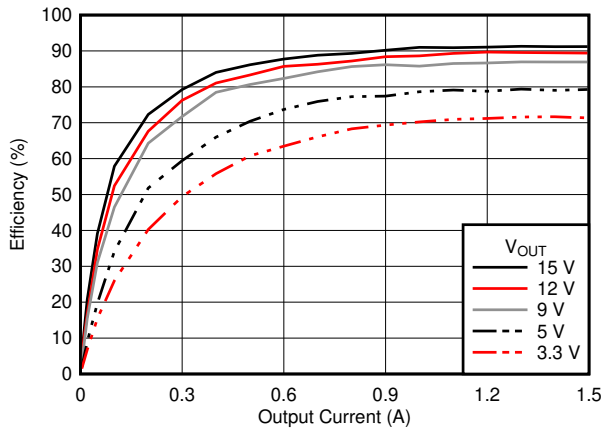

C_{OUT} = 2 × 47-μF, 25-V, ceramic

图 7-15. Output Voltage Ripple

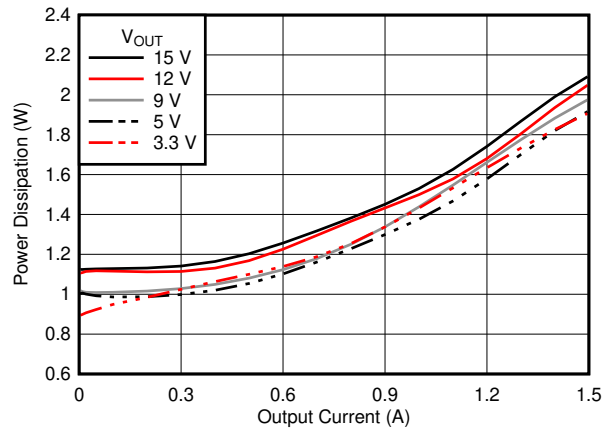
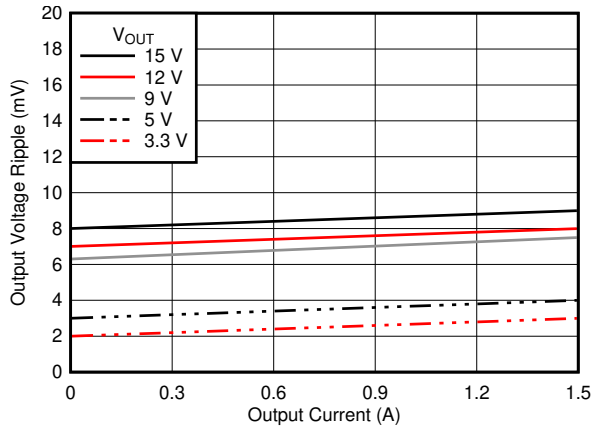
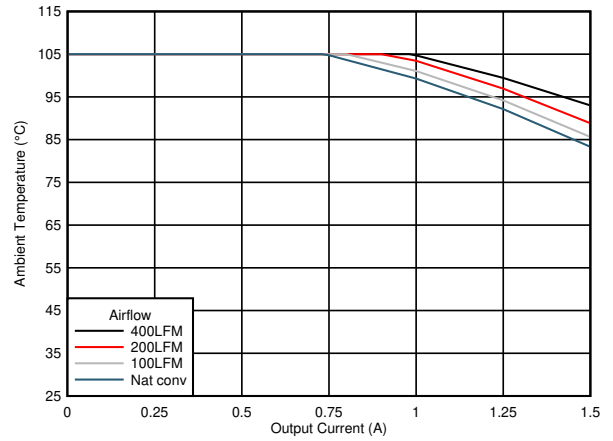

Device soldered to a 63.5-mm × 82.5-mm, 4-layer PCB

图 7-16. Safe Operating Area (V_{OUT} = 5.0 V)

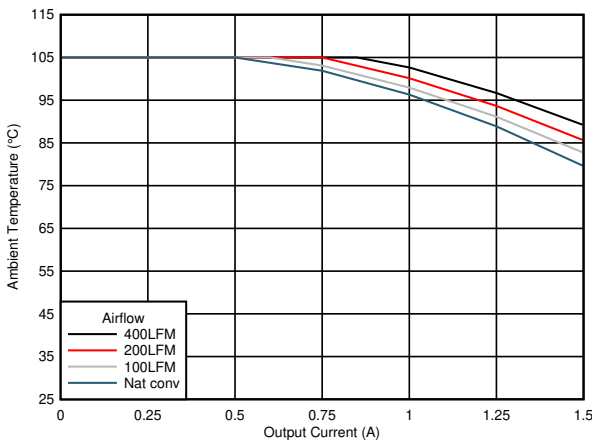

Device soldered to a 63.5-mm × 82.5-mm, 4-layer PCB

图 7-17. Safe Operating Area (V_{OUT} = 12 V)

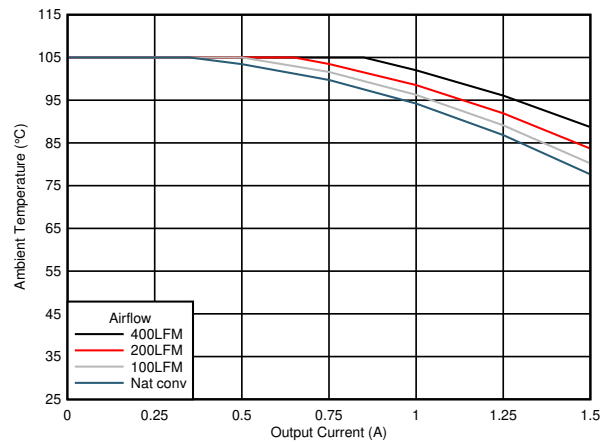

Device soldered to a 63.5-mm × 82.5-mm, 4-layer PCB

图 7-18. Safe Operating Area (V_{OUT} = 15 V)

7.9 Typical Characteristics (VIN = 60 V)

T_A = 25°C, unless otherwise noted.



图 7-19. Efficiency



图 7-20. Power Dissipation

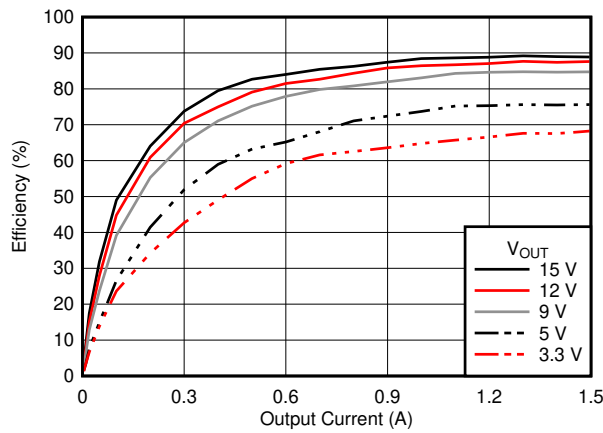

C_{OUT} = 2 × 47-μF, 25-V, ceramic

图 7-21. Output Voltage Ripple

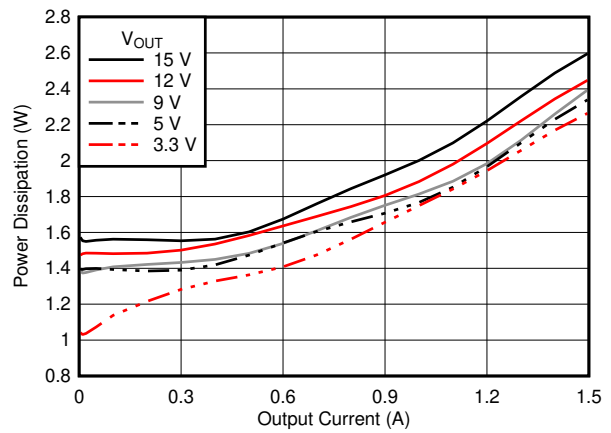
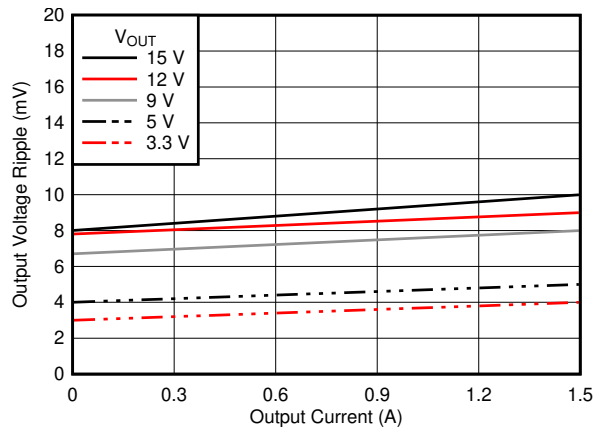
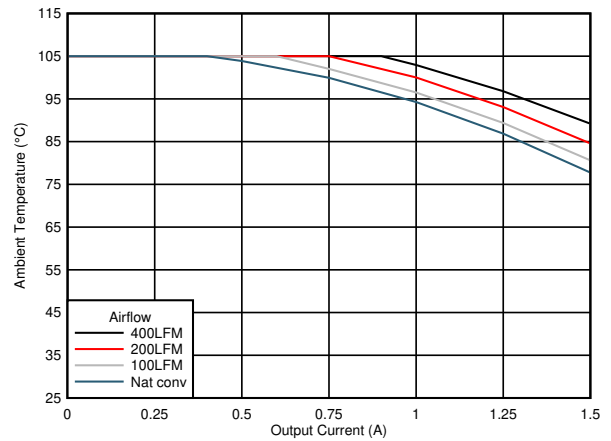

Device soldered to a 63.5-mm × 82.5-mm, 4-layer PCB

图 7-22. Safe Operating Area (V_{OUT} = 5.0 V)

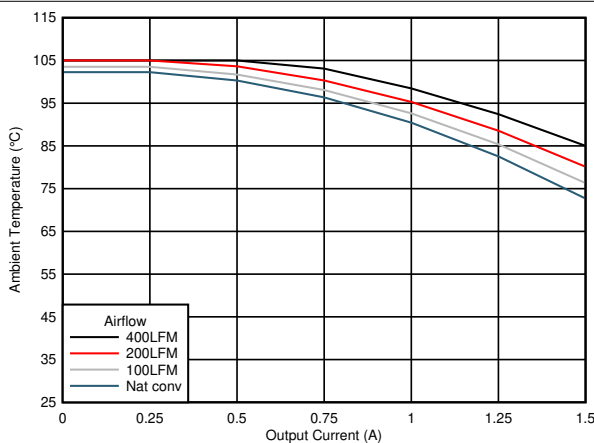

Device soldered to a 63.5-mm × 82.5-mm, 4-layer PCB

图 7-23. Safe Operating Area (V_{OUT} = 12 V)

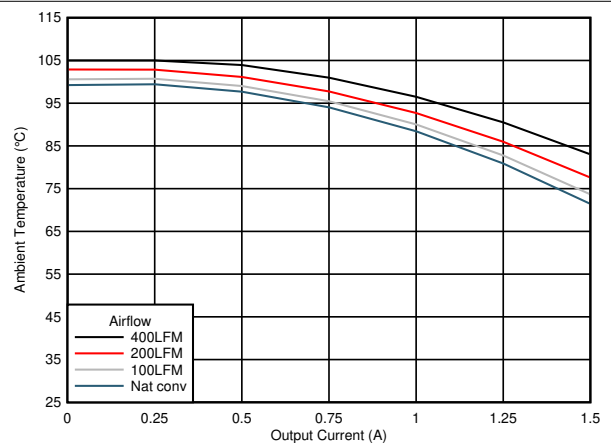

Device soldered to a 63.5-mm × 82.5-mm, 4-layer PCB

图 7-24. Safe Operating Area (V_{OUT} = 15 V)

8 Detailed Description

8.1 Overview

The TPSM5601R5Hx converter is an easy-to-use, synchronous buck, DC-DC power module that operates from a 4.2-V to 60-V supply voltage. The device is intended for step-down conversions from 5-V, 12-V, 24-V, and 48-V unregulated, semi-regulated, or fully-regulated supply rails. With an integrated power controller, inductor, and MOSFETs, the TPSM5601R5Hx delivers up to 1.5-A DC load current, with high efficiency and ultra-low input quiescent current, in a very small solution size. Although designed for simple implementation, this device offers flexibility to optimize its usage according to the target application. Control-loop compensation is not required, reducing design time and external component count.

The TPSM5601R5Hx incorporates several features for comprehensive system requirements, including the following:

- Open-drain Power Good circuit for power-rail sequencing and fault reporting
- Monotonic start-up into prebiased loads
- Precision enable with customizable hysteresis for programmable line undervoltage lockout (UVLO)
- Overcurrent and thermal shutdown with automatic recovery

Additionally, the TPSM5601R5HxS offers frequency spread-spectrum operation. These features enable a flexible and easy-to-use platform for a wide range of applications. The pin arrangement is designed for simple PCB layout, requiring as few as four external components.

8.2 Functional Block Diagram

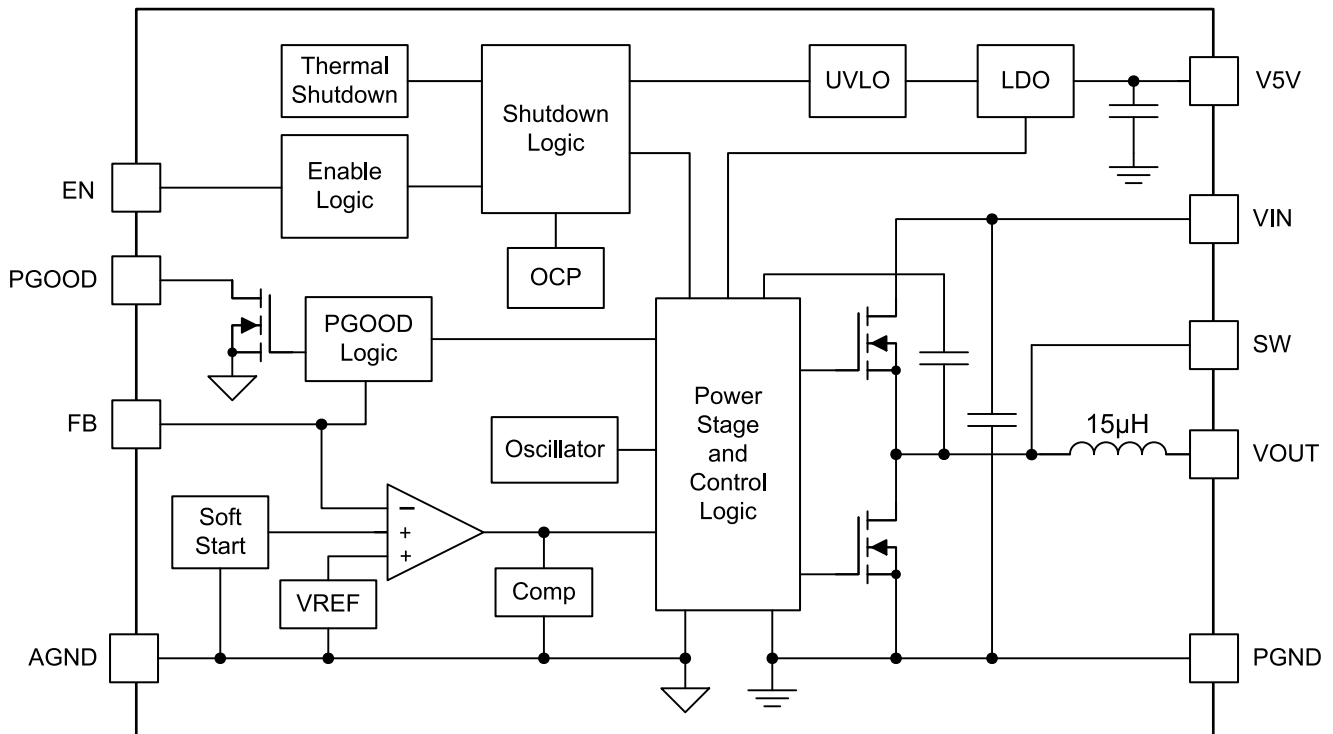

8.3 Feature Description

8.3.1 Adjustable Output Voltage (FB)

The TPSM5601R5Hx has an adjustable output voltage range of 1.0 V to 16 V. Setting the output voltage requires two resistors, R_{FBT} and R_{FBB} (see [图 8-1](#)). Connect R_{FBT} between VOUT, at the regulation point, and the FB pin. Connect R_{FBB} between the FB pin and AGND (pin 10). The recommended value of R_{FBT} is 10 k Ω . The value for R_{FBB} can be calculated using [方程式 1](#).

$$R_{FBB} = \frac{1.0}{V_{OUT} - 1.0} \times R_{FBT} \quad (1)$$



图 8-1. FB Resistor Divider

表 8-1. Standard R_{FBB} Values

VOUT (V)	R_{FBB} (k Ω) ⁽¹⁾	VOUT (V)	R_{FBB} (k Ω) ⁽¹⁾
1.0	open	3.3	4.32
1.2	49.9	5.0	2.49
1.5	20.0	7.5	1.54
1.8	12.4	10	1.10
2.0	10.0	12	0.909
2.5	6.65	15	0.715
3.0	4.99	16	0.665

(1) $R_{FBT} = 10$ k Ω

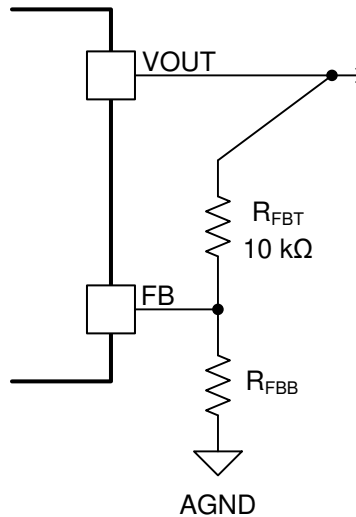
Selecting an R_{FBT} value of 10 k Ω is recommended for most applications. A larger R_{FBT} consumes less DC current, which is mandatory if light-load efficiency is critical. However, R_{FBT} larger than 1 M Ω is not recommended as the feedback path becomes more susceptible to noise. High feedback resistance generally requires more careful layout of the feedback path. It is important to keep the feedback trace as short as possible while keeping the feedback trace away from the noisy area of the PCB. For more layout recommendations, see [节 11](#).

8.3.2 Minimum Input Capacitance

The TPSM5601R5Hx requires a minimum input capacitance of 9.4 μF ($2 \times 4.7 \mu\text{F}$) of ceramic type. High-quality, ceramic-type X5R or X7R capacitors with sufficient voltage rating are required. Place the input capacitors, as close as possible to both VIN pins of the device, between VIN and PGND as shown in 节 11.1. Applications with transient load requirements can benefit from adding additional bulk capacitance to the input as well.

8.3.3 Minimum Output Capacitance

The TPSM5601R5Hx requires a minimum amount of ceramic output capacitance depending on the output voltage setting. The amount of required output capacitance is shown in 图 8-2 and is the amount of *effective* capacitance. The effects of DC bias and temperature variation must be considered when using ceramic capacitance. For ceramic capacitors, the package size, voltage rating, and dielectric material contributes to differences between the standard rated value and the actual effective value of the capacitance. When adding additional capacitance above the minimum, the capacitance can be ceramic type, low-ESR polymer type, or a combination of the two.



图 8-2. Minimum Required Output Capacitance

8.3.4 Precision Enable (EN), Undervoltage Lockout (UVLO), and Hysteresis (HYS)

The EN pin provides precision ON and OFF control for the TPSM5601R5Hx. Once the EN pin voltage exceeds the threshold voltage, the device starts operation. The simplest way to enable the device is to connect EN directly to VIN. This allows the device to start up when V_{IN} is within its valid operating range. An external logic signal can also be used to drive the EN input to toggle the output on and off and for system sequencing or protection. **This input must not be allowed to float.**

The TPSM5601R5Hx implements internal undervoltage lockout (UVLO) circuitry on the VIN pin. The device is disabled when the VIN pin voltage is below the internal VIN UVLO threshold. The internal VIN UVLO rising threshold is 3.8 V (typical) with a typical hysteresis of 500 mV.

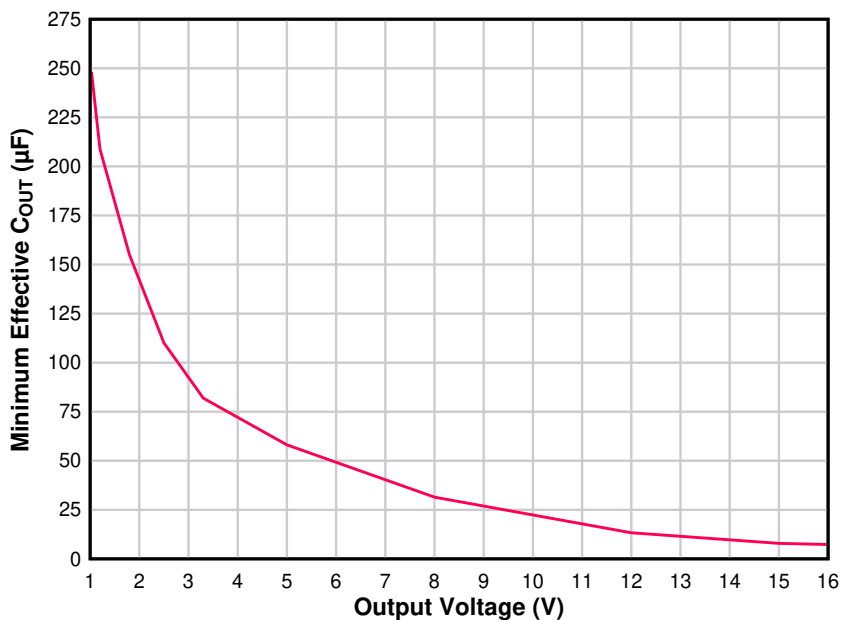
If an application requires a higher UVLO threshold, the EN input supports adjustable UVLO by connecting a resistor divider from VIN to the EN pin. Applying a voltage of ≥ 1.14 V causes the device to enter standby mode, powering the internal LDO, but not producing an output voltage. Increasing the EN voltage to 1.231 V (typ.) fully enables the device, allowing it to enter start-up mode and starting the soft-start period. When the EN input is brought below 1.121 V (110 mV hysteresis), the regulator stops running and enters standby mode. Further decrease in the EN voltage to below 0.3 V completely shuts down the device.

The TPSM5601R5Hx utilizes a reference-based soft start that prevents output voltage overshoots and large inrush currents as the regulator is starting up. The rise time of the output voltage is about 4 ms.

8.3.5 Power Good (PGOOD)

The TPSM5601R5Hx provides a PGOOD signal to indicate when the output voltage is within regulation. Use the PGOOD signal for output monitoring, fault protection, or start-up sequencing of downstream converters. PGOOD is an open-drain output that requires a pullup resistor to a DC supply not greater than 18 V. V5V or VOUT can be used as the pullup voltage source. Typical range of pullup resistance is 10 k Ω to 100 k Ω . If necessary, use a resistor divider to decrease the voltage from a higher voltage pullup rail. If this function is not needed, the PGOOD pin must be grounded.

When the output voltage exceeds 95% (rising) or decreases below 105% (falling) of the setpoint, the internal PGOOD switch turns off and PGOOD can be pulled high by the external pullup. If the FB voltage falls below 93% or rises above 107% of the setpoint, the internal PGOOD switch turns on, and PGOOD is pulled low to indicate that the output voltage is out of regulation.

Note that during initial power up, a delay of about 4 ms (typical) is inserted from the time that EN is asserted to the time that the power-good flag goes high. This delay only occurs during start-up and is not encountered during normal operation of the power-good function.

8.3.6 Spread Spectrum Operation

Spread spectrum is a factory option in the TPSM5601R5HS variant. The purpose of the spread spectrum is to eliminate peak emissions at specific frequencies by spreading emissions across a wider range of frequencies than a part with fixed frequency operation. In most systems, low frequency conducted emissions from the first few harmonics of the switching frequency can be easily filtered. A more difficult design criterion is reduction of emissions at higher harmonics which fall in the FM band. These harmonics often couple to the environment through electric fields around the switch node. The TPSM5601R5HS device with triangular spread spectrum uses a $\pm 4\%$ spreading rate (typical) with the modulation rate set at 16 kHz (typical). The spread spectrum is only available while the internal clock is free running at its natural frequency. Any of the following conditions override spread spectrum, turning it off:

- At high input voltages/low output voltage ratio when the device operates at minimum on time the internal clock is slowed disabling spread spectrum.
- The clock is slowed during dropout.

8.3.7 Overcurrent Protection (OCP)

The TPSM5601R5Hx is protected from overcurrent conditions using cycle-by-cycle current limiting for overload conditions and hiccup mode for short circuits. The current is compared every switching cycle to the current limit threshold. During an overcurrent condition, the output voltage decreases.

8.3.8 Thermal Shutdown

Thermal shutdown is an integrated self-protection used to limit junction temperature and prevent damage related to overheating. Thermal shutdown turns off the device when the junction temperature exceeds 170°C (typ.) to prevent further power dissipation and temperature rise. Junction temperature decreases after shutdown, and the TPSM5601R5Hx restarts when the junction temperature falls to 158°C (typ.).

8.4 Device Functional Modes

8.4.1 Active Mode

The TPSM5601R5Hx is in active mode when VIN is above the turn-on threshold and the EN pin voltage is above the EN high threshold. Connect the EN pin to VIN to allow the device to start up when a valid input voltage is applied. This allows self start-up of the TPSM5601R5Hx when the input voltage is in the operation range of 4.2 V to 60 V. Connecting a resistor divider between VIN, EN, and AGND adjusts the UVLO to delay the turn on until VIN is closer to its regulated voltage.

8.4.2 Standby Mode

Start-up and shutdown are controlled by the EN input. This input features precision thresholds, allowing the use of an external voltage divider to provide an adjustable input UVLO. Applying a voltage of ≥ 1.14 causes the device to enter standby mode, powering the internal LDO, but not producing an output voltage. Increasing the EN voltage to 1.231 V (typ.) fully enables the device, allowing it to enter start-up mode and starting the soft-start period. When the EN input is brought below 1.121 V (110-mV hysteresis), the regulator stops running and enters standby mode. Further decrease in the EN voltage to below 0.3 V completely shuts down the device.

8.4.3 Shutdown Mode

The EN pin provides ON and OFF control for the TPSM5601R5Hx. When V_{EN} is below the EN low threshold, the device is in shutdown mode. Both the internal LDO and the switching regulator are off. The quiescent current in shutdown mode drops to 5 μ A at $V_{IN} = 24$ V.

9 Applications and Implementation

Note

以下应用部分中的信息不属于 TI 器件规格的范围，TI 不担保其准确性和完整性。TI 的客户应负责确定器件是否适用于其应用。客户应验证并测试其设计，以确保系统功能。

9.1 Application Information

The TPSM5601R5Hx only requires a few external components to convert from a wide range of supply voltages to a fixed output voltage. To expedite and streamline the process of designing of a TPSM5601R5Hx, WEBENCH® online software is available to generate complete designs, leveraging iterative design procedures and access to comprehensive component databases. The following section describes the design procedure to configure the TPSM5601R5Hx power module.

As mentioned previously, the TPSM5601R5Hx also integrates several optional features to meet system design requirements, including precision enable, UVLO, and PGOOD indicator. The application circuit detailed below shows TPSM5601R5Hx configuration options suitable for several application use cases. Refer to the [TPSM5601R5HxEVM](#) user's guide for more detail.

9.2 Typical Application

图 9-1 shows the schematic diagram of a 24-V input, 5-V output, 1.5-A converter.



图 9-1. TPSM5601R5Hx Typical Schematic

9.2.1 Design Requirements

For this design example, use the parameters listed in 表 9-1 as the input parameters and follow the design procedures in 节 9.2.2.

表 9-1. Design Example Parameters

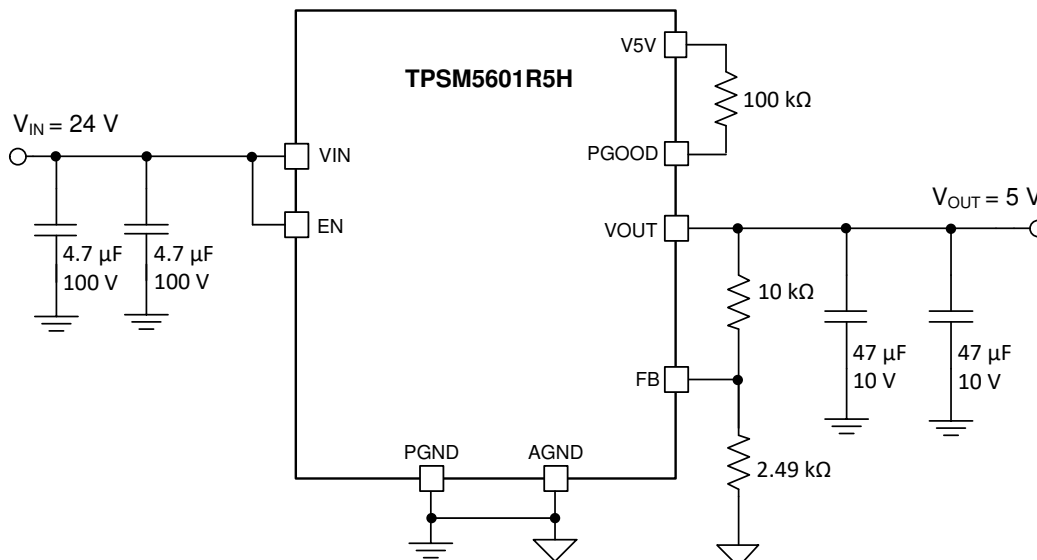
DESIGN PARAMETER	VALUE
Input voltage V_{IN}	24 V typical
Output voltage V_{OUT}	5 V
Output current rating	1.5 A

9.2.2 Detailed Design Procedure

9.2.2.1 Custom Design With WEBENCH® Tools

Click [here](#) to create a custom design using the TPSM5601R5Hx device with the WEBENCH® Power Designer.

1. Start by entering the input voltage (V_{IN}), output voltage (V_{OUT}), and output current (I_{OUT}) requirements.
2. Optimize the design for key parameters such as efficiency, footprint, and cost using the optimizer dial.
3. Compare the generated design with other possible solutions from Texas Instruments.

The WEBENCH Power Designer provides a customized schematic along with a list of materials with real-time pricing and component availability.

In most cases, these actions are available:

- Run electrical simulations to see important waveforms and circuit performance.
- Run thermal simulations to understand board thermal performance.
- Export customized schematic and layout into popular CAD formats.
- Print PDF reports for the design, and share the design with colleagues.

Get more information about WEBENCH tools at www.ti.com/WEBENCH.

9.2.2.2 Output Voltage Setpoint

The output voltage of the TPSM5601R5Hx device is externally adjustable using a resistor divider. The recommended value of R_{FBT} is 10 k Ω . The value for R_{FBB} can be selected from [表 8-1](#) or calculated using [方程式 2](#):

$$R_{FBB} = \frac{1.0}{V_{OUT} - 1.0} \times R_{FBT} \quad (2)$$

For the desired output voltage of 5 V, the formula yields a value of 2.5 k Ω . Choose the closest available standard value of 2.49 k Ω for R_{FBB} .

9.2.2.3 Input Capacitors

The TPSM5601R5Hx requires a minimum input capacitance of $2 \times 4.7\text{-}\mu\text{F}$ ceramic type. High-quality ceramic type X5R or X7R capacitors with sufficient voltage rating are recommended. The voltage rating of input capacitors must be greater than the maximum input voltage.

For this design, $2 \times 4.7\text{-}\mu\text{F}$, 100-V ceramic capacitors are selected.

9.2.2.4 Output Capacitor Selection

The TPSM5601R5Hx requires a minimum amount of output capacitance for proper operation. The minimum amount of required output varies depending on the output voltage. See [图 8-2](#) for the required output capacitance. Additional output capacitance can be added to reduce ripple voltage or for applications with transient load requirements.

For this design example, $2 \times 47\text{-}\mu\text{F}$, 10-V, ceramic capacitors are used.

9.2.2.5 Power Good Signal

Applications requiring a power good signal to indicate that the output voltage is present and in regulation must use a pullup resistor between the PGOOD pin and a valid voltage source.

For this design a 100-k Ω resistor is placed between the PGOOD pin and the V5V pin (the internal 5-V LDO output).

9.2.3 Application Curves



图 9-2. Start-up Waveforms



图 9-3. Enable Shutdown Waveforms

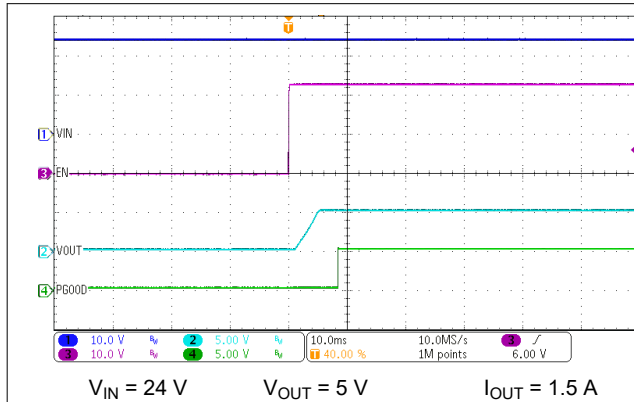

图 9-4. Output Ripple Waveform

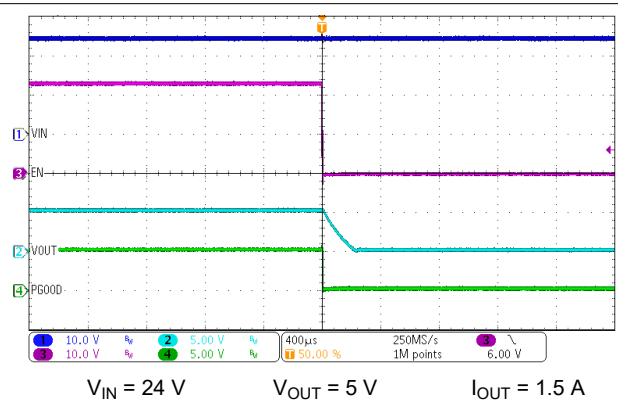

图 9-5. Transient Response Waveform

10 Power Supply Recommendations

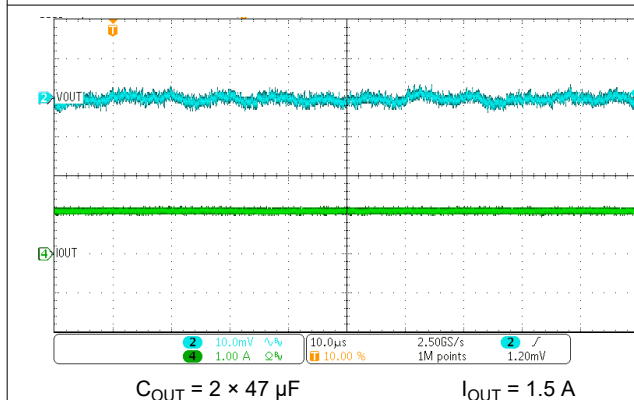
The TPSM5601R5Hx is designed to operate from an input voltage supply range between 4.2 V and 60 V. This input supply must be able to provide the maximum input current and maintain a voltage above the set UVLO voltage. Ensure that the resistance of the input supply rail is low enough that an input current transient does not cause a high enough drop at the TPSM5601R5Hx supply rail to cause a false UVLO fault triggering and system reset. If the input supply is located more than a few inches from the TPSM5601R5Hx, additional bulk capacitance can be required in addition to the ceramic input capacitance. A 47- μF electrolytic capacitor is a typical choice for this function, whereby the capacitor ESR provides a level of damping against input filter resonances. A typical ESR of 0.5 Ω provides enough damping for most input circuit configurations.

11 Layout

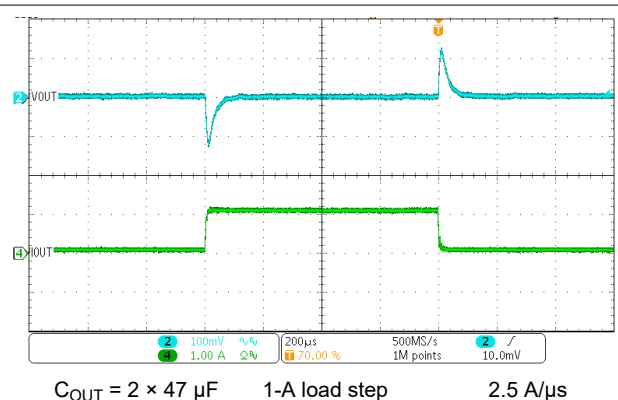
The performance of any switching power supply depends as much upon the layout of the PCB as the component selection. Use the following guidelines to design a PCB with the best power conversion performance, optimal thermal performance, and minimal generation of unwanted EMI.

11.1 Layout Guidelines

To achieve optimal electrical and thermal performance, an optimized PCB layout is required. 图 11-1 and 图 11-2 show a typical PCB layout. Some considerations for an optimized layout are:

- Use large copper areas for power planes (VIN, VOUT, and PGND) to minimize conduction loss and thermal stress.
- **Connect all PGND pins together using copper plane.**
- Connect AGND pin to the PGND copper at a single point near the pin.
- Place ceramic input and output capacitors close to the device pins to minimize high frequency noise.
- Locate additional output capacitors between the ceramic capacitor and the load.
- Place R_{FBT} and R_{FBB} as close as possible to their respective pins.
- Use multiple vias to connect the power planes to internal layers.

11.2 Layout Example



图 11-1. Typical Layout



图 11-2. Typical Top-Layer

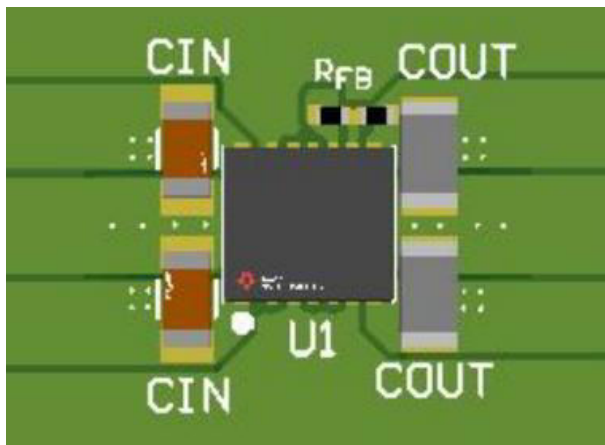

图 11-3. Typical Mid-Layer

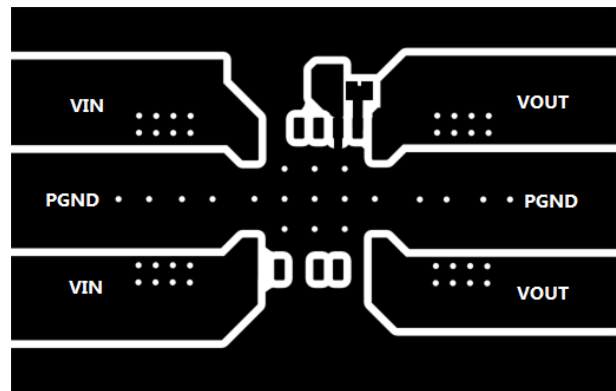

图 11-4. Typical PGND-Layer

11.2.1 Theta JA versus PCB Area

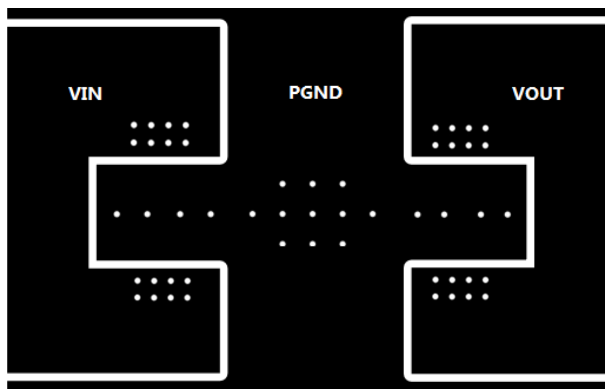
The amount of PCB copper as well as airflow effects the thermal performance of the device. 图 11-5 shows the effects of copper area and airflow on the junction-to-ambient thermal resistance ($R_{\theta JA}$) of the TPSM5601R5Hx. The junction-to-ambient thermal resistance versus PCB area is plotted for a 4-layer PCB.

To determine the required copper area for an application:

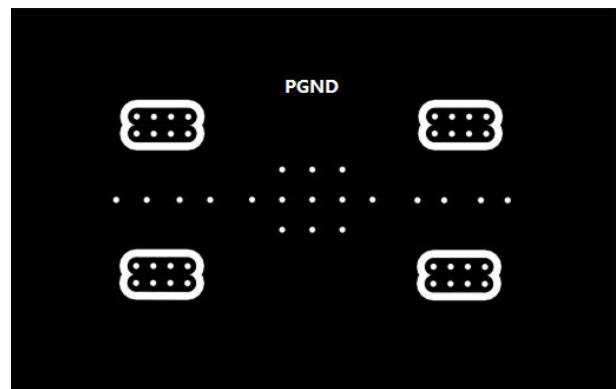
1. Determine the maximum power dissipation of the device in the application by referencing the power dissipation graphs in the *Typical Characteristics*.
2. Calculate the maximum θ_{JA} using 方程式 3 and the maximum ambient temperature of the application.

$$\theta_{JA} = \frac{(125^{\circ}\text{C} - T_{A(\text{max})})}{P_{D(\text{max})}} \quad (^{\circ}\text{C}/\text{W}) \tag{3}$$

3. Reference 图 11-5 to determine the minimum required PCB area for the application conditions.



图 11-5. θ_{JA} vs PCB Area

11.2.2 Package Specifications

表 11-1. Package Specifications Table

TPSM5601R5H		VALUE	UNIT
Weight		429	mg
Flammability	Meets UL 94 V-O		
MTBF Calculated Reliability	Per Bellcore TR-332, 50% stress, $T_A = 40^{\circ}\text{C}$, ground benign	87.7	MHrs

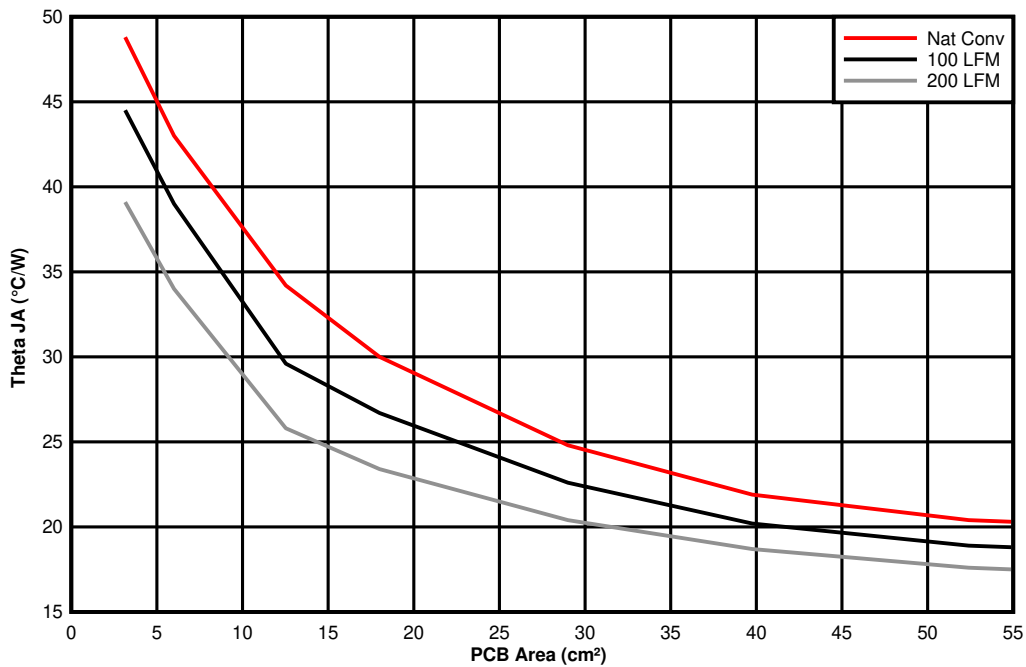
11.2.3 EMI

The TPSM5601R5H is compliant with EN55011 radiated emissions. 图 11-6 through 图 11-9 show typical examples of radiated emission plots for the TPSM5601R5H. The graphs include the plots of the antenna in the horizontal and vertical positions.

11.2.3.1 EMI Plots

EMI plots were measured using the standard TPSM5601R5HEVM.



图 11-6. Radiated Emissions 24-V Input, 5-V Output, 1.5-A Load



图 11-7. Radiated Emissions 24-V Input, 5-V Output, 1.5-A Load (Spread spectrum)

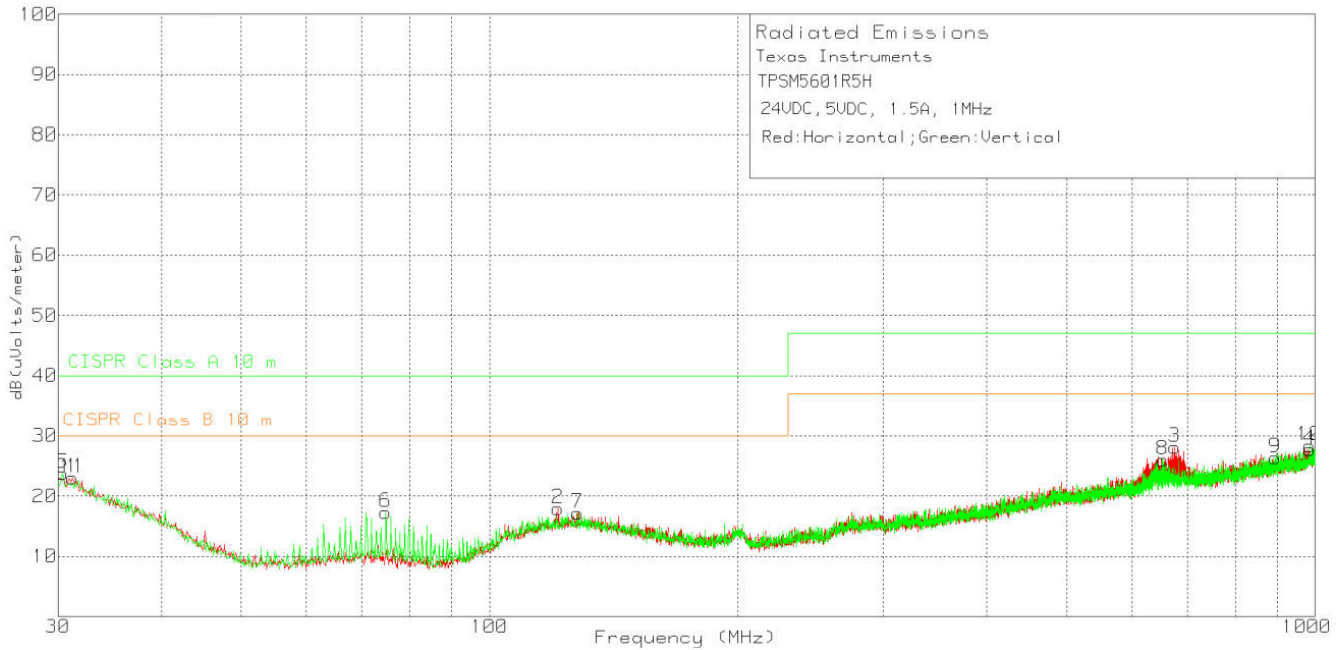

图 11-8. Radiated Emissions 24-V Input, 12-V Output, 1.5-A Load

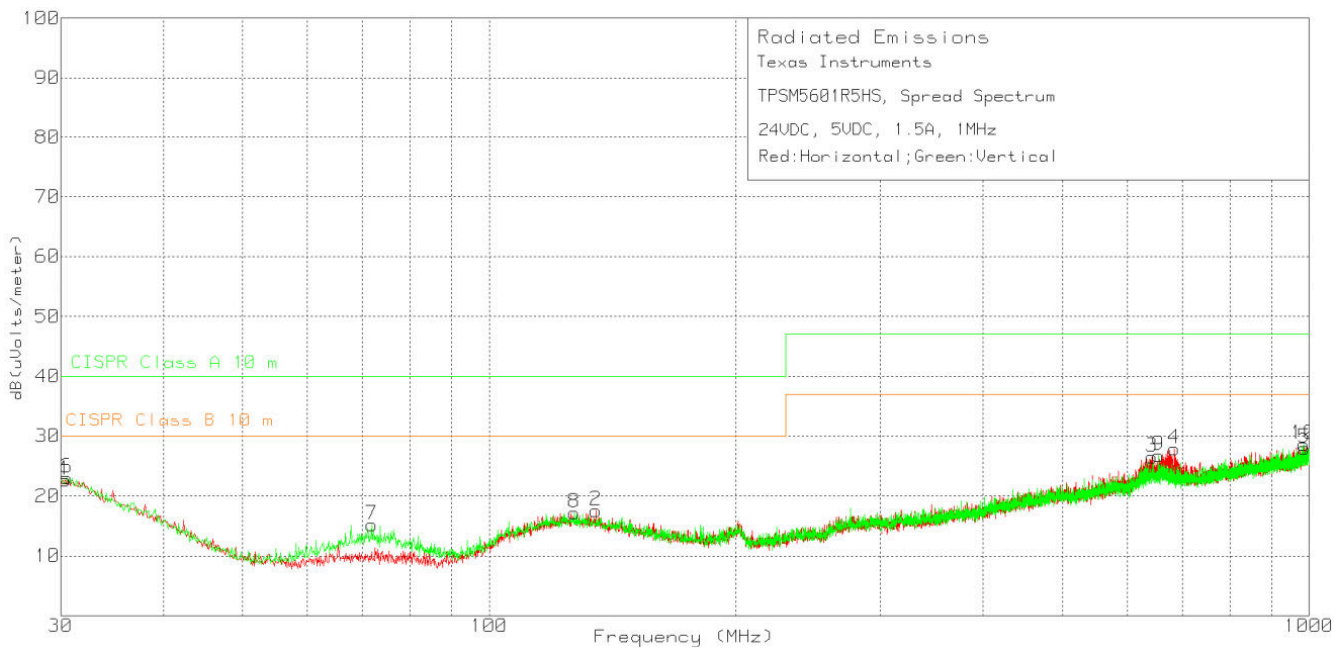

图 11-9. Radiated Emissions 48-V Input, 12-V Output, 1.5-A Load

12 Device and Documentation Support

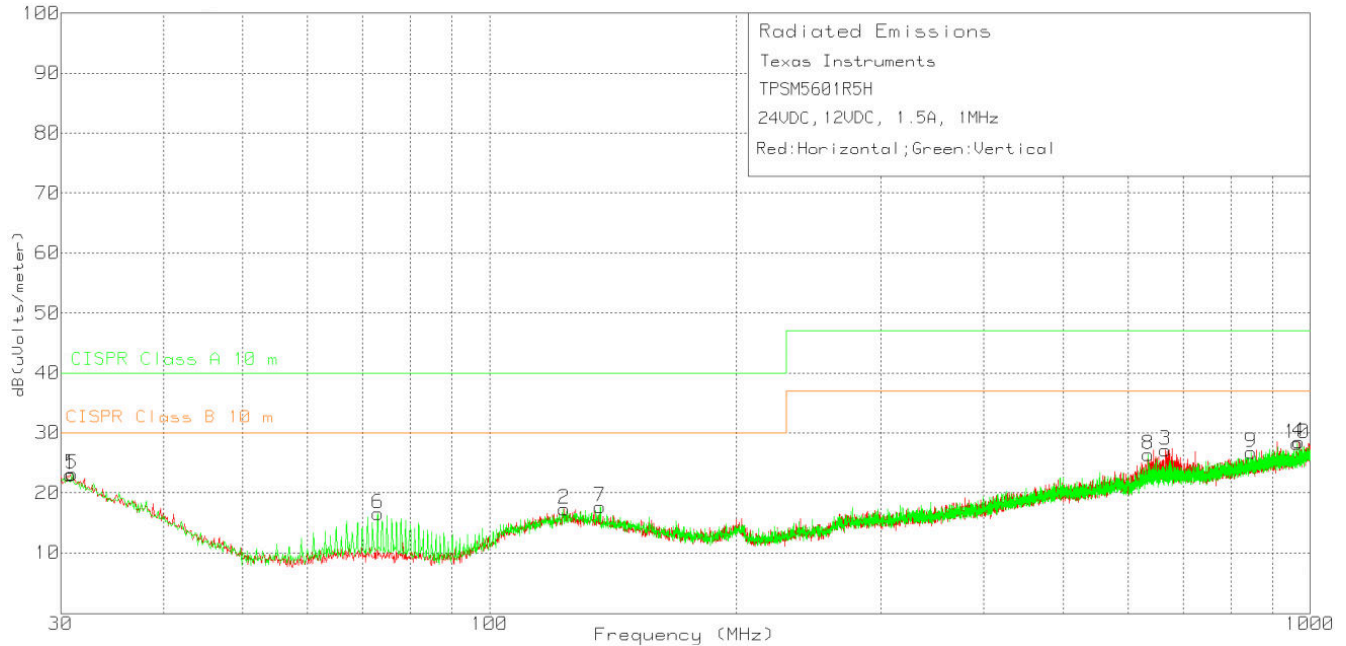
12.1 Device Support

12.1.1 第三方产品免责声明

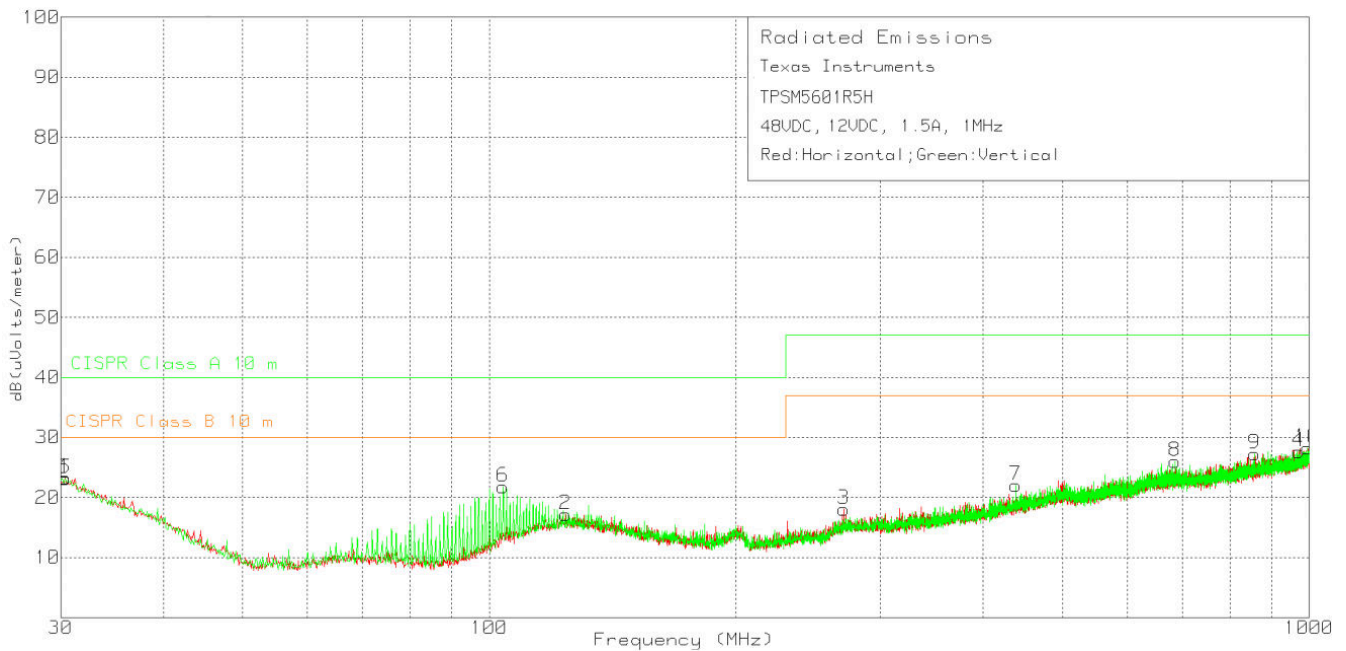
TI 发布的与第三方产品或服务有关的信息，不能构成与此类产品或服务或保修的适用性有关的认可，不能构成此类产品或服务单独或与任何 TI 产品或服务一起的表示或认可。

12.1.2 Development Support

For development support, see the following:

- For TI's reference design library, visit [TI Designs](#).
- To view a related device of this product, see the [TPSM5601R5Hx](#).

12.1.2.1 Custom Design With WEBENCH® Tools

[Click here](#) to create a custom design using the TPSM5601R5H device with WEBENCH® Power Designer.

1. Start by entering the input voltage (V_{IN}), output voltage (V_{OUT}), and output current (I_{OUT}) requirements.
2. Optimize the design for key parameters such as efficiency, footprint, and cost using the optimizer dial.
3. Compare the generated design with other possible solutions from Texas Instruments.

The WEBENCH Power Designer provides a customized schematic along with a list of materials with real-time pricing and component availability.

In most cases, these actions are available:

- Run electrical simulations to see important waveforms and circuit performance.
- Run thermal simulations to understand board thermal performance.
- Export customized schematic and layout into popular CAD formats.
- Print PDF reports for the design, and share the design with colleagues.

Get more information about WEBENCH tools at www.ti.com/WEBENCH.

12.2 Documentation Support

12.2.1 Related Documentation

For related documentation, see the following:

- Texas Instruments, [TPSM5601R5HxEVM User's Guide](#)
- Texas Instruments, [Using the TPSM5601R5Hx in an Inverting Buck-Boost Topology Application Report](#)
- Texas Instruments, [Using New Thermal Metrics Application Report](#)
- Texas Instruments, [Semiconductor and IC Package Thermal Metrics Application Report](#)

12.3 Receiving Notification of Documentation Updates

To receive notification of documentation updates, navigate to the device product folder on ti.com. In the upper right corner, click on *Alert me* to register and receive a weekly digest of any product information that has changed. For change details, review the revision history included in any revised document.

12.4 支持资源

[TI E2E™ 支持论坛](#)是工程师的重要参考资料，可直接从专家获得快速、经过验证的解答和设计帮助。搜索现有解答或提出自己的问题可获得所需的快速设计帮助。

链接的内容由各个贡献者“按原样”提供。这些内容并不构成 TI 技术规范，并且不一定反映 TI 的观点；请参阅 TI 的《[使用条款](#)》。

12.5 Trademarks

HotRod™ and TI E2E™ are trademarks of Texas Instruments.
WEBENCH® is a registered trademark of Texas Instruments.
is a registered trademark of Texas Instruments.

所有商标均为其各自所有者的财产。

12.6 Electrostatic Discharge Caution



This integrated circuit can be damaged by ESD. Texas Instruments recommends that all integrated circuits be handled with appropriate precautions. Failure to observe proper handling and installation procedures can cause damage.

ESD damage can range from subtle performance degradation to complete device failure. Precision integrated circuits may be more susceptible to damage because very small parametric changes could cause the device not to meet its published specifications.

12.7 术语表

[TI 术语表](#) 本术语表列出并解释了术语、首字母缩略词和定义。

13 Mechanical, Packaging, and Orderable Information

The following pages include mechanical packaging and orderable information. This information is the most current data available for the designated devices. This data is subject to change without notice and revision of this document. For browser-based versions of this datasheet, refer to the left-hand navigation.

PACKAGING INFORMATION

Orderable Device	Status (1)	Package Type	Package Drawing	Pins	Package Qty	Eco Plan (2)	Lead finish/ Ball material (6)	MSL Peak Temp (3)	Op Temp (°C)	Device Marking (4/5)	Samples
TPSM5601R5HEXTRDAR	ACTIVE	B3QFN	RDA	15	1000	RoHS & Green	NIPDAU	Level-3-245C-168 HR	-55 to 125	5601R5HEXT	Samples
TPSM5601R5HRDAR	ACTIVE	B3QFN	RDA	15	1000	RoHS & Green	NIPDAU	Level-3-245C-168 HR	-40 to 125	5601R5H	Samples
TPSM5601R5HSRDAR	ACTIVE	B3QFN	RDA	15	1000	RoHS & Green	NIPDAU	Level-3-245C-168 HR	-40 to 125	5601R5HS	Samples

(1) The marketing status values are defined as follows:

ACTIVE: Product device recommended for new designs.

LIFEBUY: TI has announced that the device will be discontinued, and a lifetime-buy period is in effect.

NRND: Not recommended for new designs. Device is in production to support existing customers, but TI does not recommend using this part in a new design.

PREVIEW: Device has been announced but is not in production. Samples may or may not be available.

OBSOLETE: TI has discontinued the production of the device.

(2) **RoHS:** TI defines "RoHS" to mean semiconductor products that are compliant with the current EU RoHS requirements for all 10 RoHS substances, including the requirement that RoHS substance do not exceed 0.1% by weight in homogeneous materials. Where designed to be soldered at high temperatures, "RoHS" products are suitable for use in specified lead-free processes. TI may reference these types of products as "Pb-Free".

RoHS Exempt: TI defines "RoHS Exempt" to mean products that contain lead but are compliant with EU RoHS pursuant to a specific EU RoHS exemption.

Green: TI defines "Green" to mean the content of Chlorine (Cl) and Bromine (Br) based flame retardants meet JS709B low halogen requirements of <=1000ppm threshold. Antimony trioxide based flame retardants must also meet the <=1000ppm threshold requirement.

(3) MSL, Peak Temp. - The Moisture Sensitivity Level rating according to the JEDEC industry standard classifications, and peak solder temperature.

(4) There may be additional marking, which relates to the logo, the lot trace code information, or the environmental category on the device.

(5) Multiple Device Markings will be inside parentheses. Only one Device Marking contained in parentheses and separated by a "~" will appear on a device. If a line is indented then it is a continuation of the previous line and the two combined represent the entire Device Marking for that device.

(6) Lead finish/Ball material - Orderable Devices may have multiple material finish options. Finish options are separated by a vertical ruled line. Lead finish/Ball material values may wrap to two lines if the finish value exceeds the maximum column width.

Important Information and Disclaimer:The information provided on this page represents TI's knowledge and belief as of the date that it is provided. TI bases its knowledge and belief on information provided by third parties, and makes no representation or warranty as to the accuracy of such information. Efforts are underway to better integrate information from third parties. TI has taken and continues to take reasonable steps to provide representative and accurate information but may not have conducted destructive testing or chemical analysis on incoming materials and chemicals. TI and TI suppliers consider certain information to be proprietary, and thus CAS numbers and other limited information may not be available for release.

In no event shall TI's liability arising out of such information exceed the total purchase price of the TI part(s) at issue in this document sold by TI to Customer on an annual basis.

TAPE AND REEL INFORMATION

QUADRANT ASSIGNMENTS FOR PIN 1 ORIENTATION IN TAPE

*All dimensions are nominal

Device	Package Type	Package Drawing	Pins	SPQ	Reel Diameter (mm)	Reel Width W1 (mm)	A0 (mm)	B0 (mm)	K0 (mm)	P1 (mm)	W (mm)	Pin1 Quadrant
TPSM5601R5HEXTRDAR	B3QFN	RDA	15	1000	330.0	16.4	5.28	5.78	4.28	8.0	16.0	Q1
TPSM5601R5HRDAR	B3QFN	RDA	15	1000	330.0	16.4	5.28	5.78	4.28	8.0	16.0	Q1
TPSM5601R5HSRDAR	B3QFN	RDA	15	1000	330.0	16.4	5.28	5.78	4.28	8.0	16.0	Q1

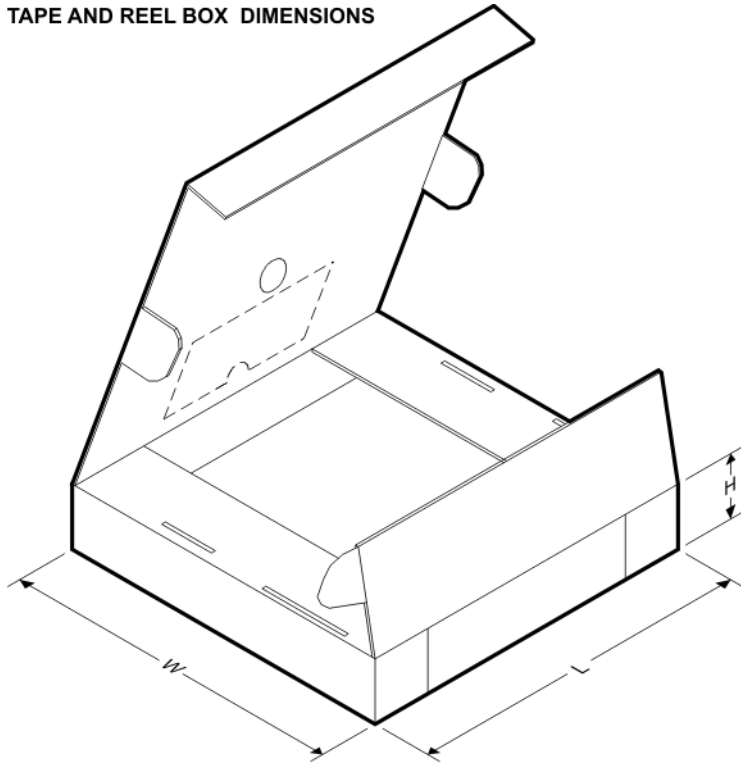
TAPE AND REEL BOX DIMENSIONS

*All dimensions are nominal

Device	Package Type	Package Drawing	Pins	SPQ	Length (mm)	Width (mm)	Height (mm)
TPSM5601R5HEXTRDAR	B3QFN	RDA	15	1000	336.0	336.0	48.0
TPSM5601R5HRDAR	B3QFN	RDA	15	1000	336.0	336.0	48.0
TPSM5601R5HSRDAR	B3QFN	RDA	15	1000	336.0	336.0	48.0

RDA0015A

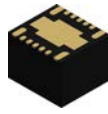

PACKAGE OUTLINE

B3QFN - 4.1 mm max height

PLASTIC QUAD FLATPACK - NO LEAD

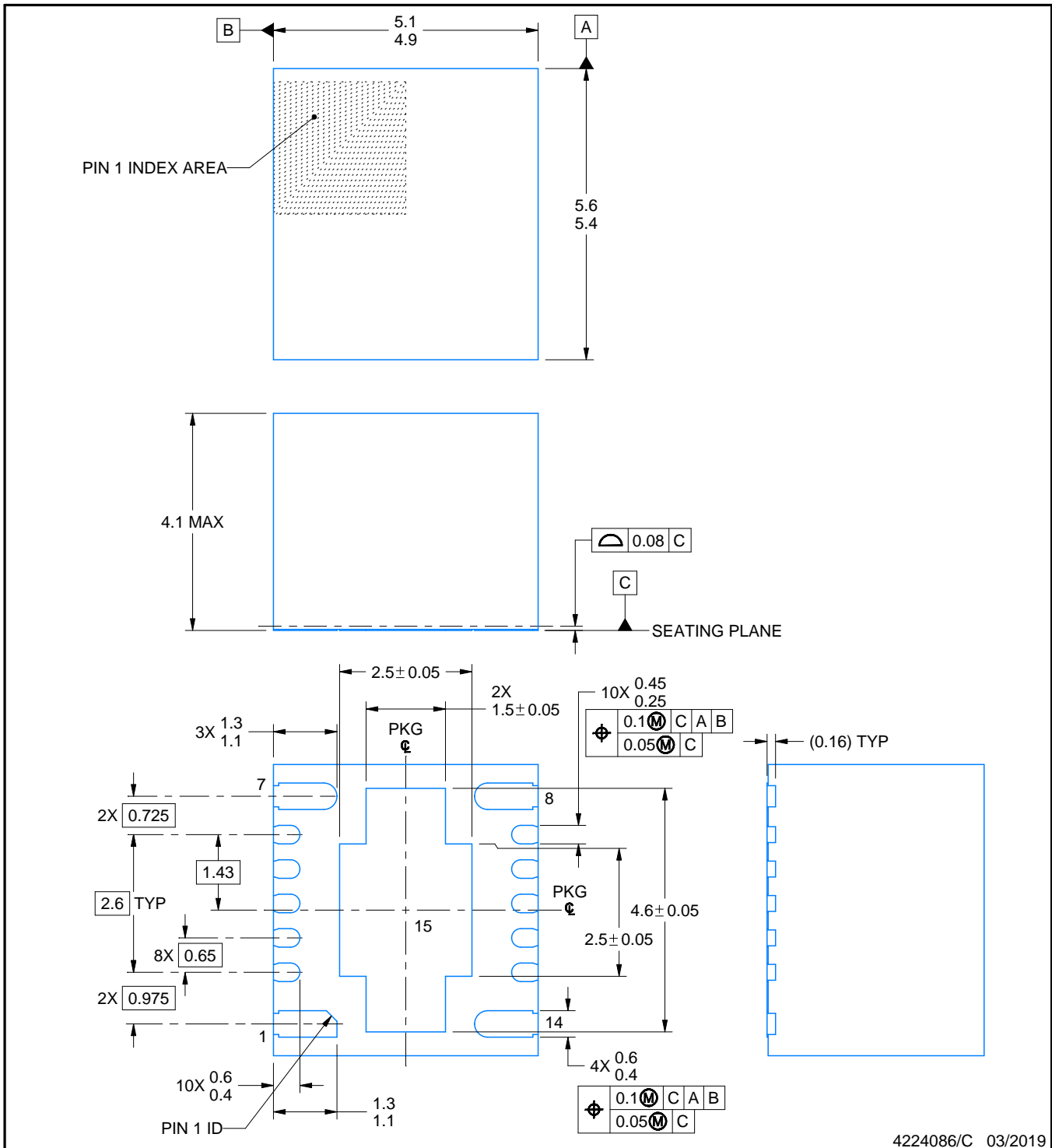

NOTES:

1. All linear dimensions are in millimeters. Any dimensions in parenthesis are for reference only. Dimensioning and tolerancing per ASME Y14.5M.
2. This drawing is subject to change without notice.
3. The package thermal pad must be soldered to the printed circuit board for optimal thermal and mechanical performance.

EXAMPLE BOARD LAYOUT

RDA0015A

B3QFN - 4.1 mm max height

PLASTIC QUAD FLATPACK - NO LEAD

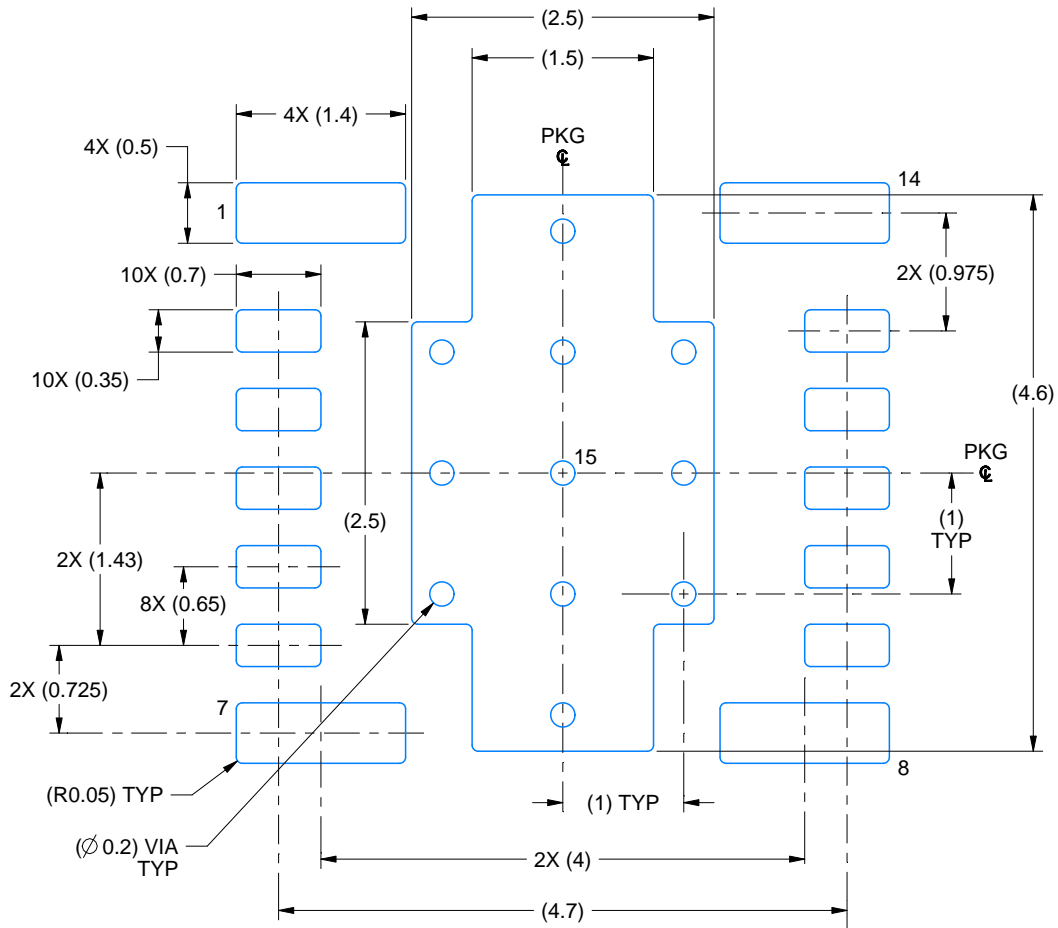

LAND PATTERN EXAMPLE
EXPOSED METAL SHOWN
SCALE: 16X

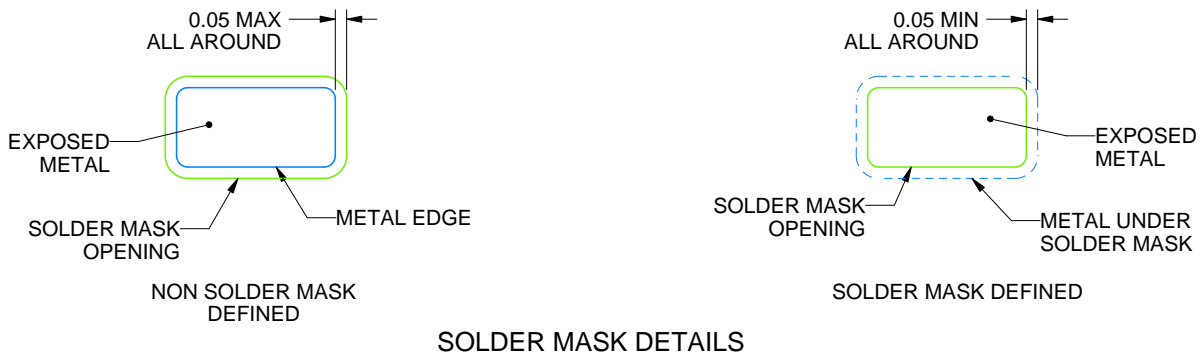

SOLDER MASK DETAILS

4224086/C 03/2019

NOTES: (continued)

- This package is designed to be soldered to a thermal pad on the board. For more information, see Texas Instruments literature number SLUA271 (www.ti.com/lit/slua271).
- Vias are optional depending on application, refer to device data sheet. If any vias are implemented, refer to their locations shown on this view. It is recommended that vias under paste be filled, plugged or tented.

EXAMPLE STENCIL DESIGN

RDA0015A

B3QFN - 4.1 mm max height

PLASTIC QUAD FLATPACK - NO LEAD

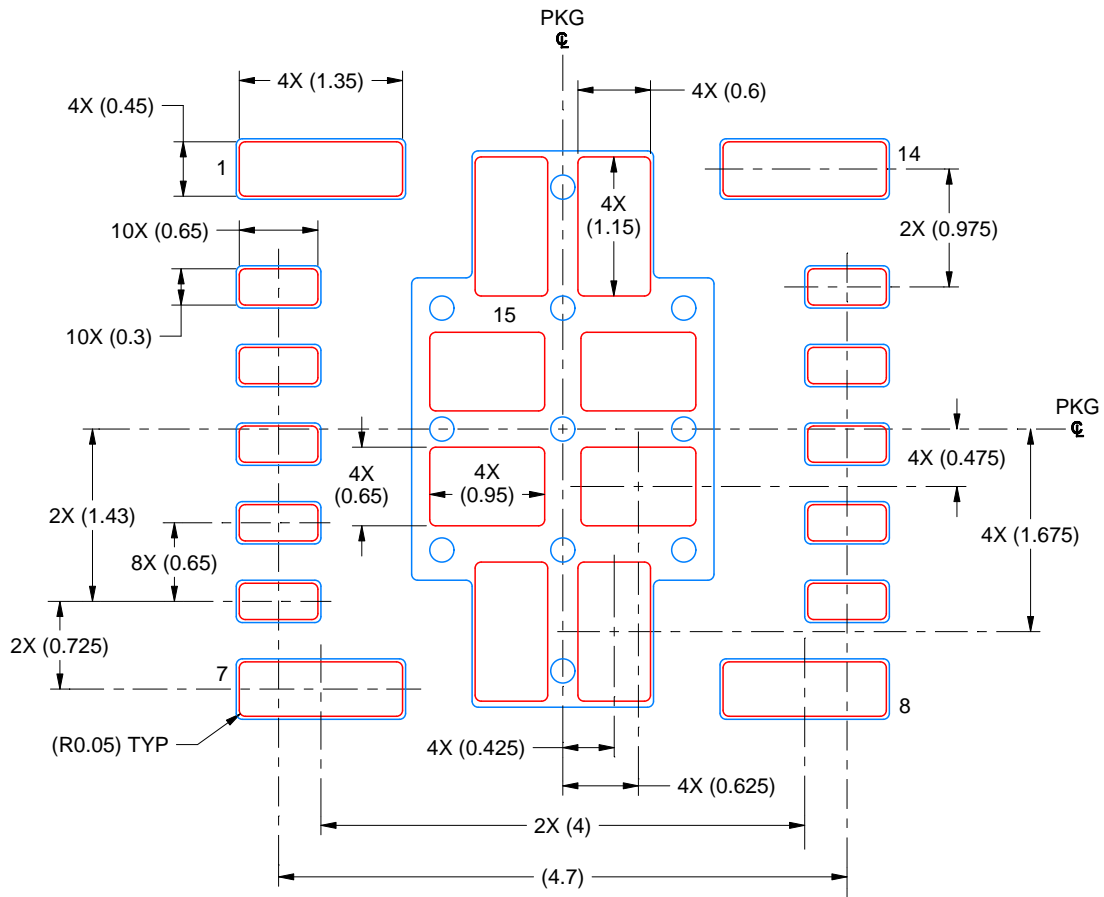

SOLDER PASTE EXAMPLE
BASED ON 0.125 mm THICK STENCIL

EXPOSED PAD 15:
56% PRINTED SOLDER COVERAGE BY AREA
SCALE: 16X

4224086/C 03/2019

NOTES: (continued)

6. Laser cutting apertures with trapezoidal walls and rounded corners may offer better paste release. IPC-7525 may have alternate design recommendations.

重要声明和免责声明

TI“按原样”提供技术和可靠性数据（包括数据表）、设计资源（包括参考设计）、应用或其他设计建议、网络工具、安全信息和其他资源，不保证没有瑕疵且不做任何明示或暗示的担保，包括但不限于对适销性、某特定用途方面的适用性或不侵犯任何第三方知识产权的暗示担保。

这些资源可供使用 TI 产品进行设计的熟练开发人员使用。您将自行承担以下全部责任：(1) 针对您的应用选择合适的 TI 产品，(2) 设计、验证并测试您的应用，(3) 确保您的应用满足相应标准以及任何其他功能安全、信息安全、监管或其他要求。

这些资源如有变更，恕不另行通知。TI 授权您仅可将这些资源用于研发本资源所述的 TI 产品的应用。严禁对这些资源进行其他复制或展示。您无权使用任何其他 TI 知识产权或任何第三方知识产权。您应全额赔偿因在这些资源的使用中对 TI 及其代表造成的任何索赔、损害、成本、损失和债务，TI 对此概不负责。

TI 提供的产品受 [TI 的销售条款](#) 或 [ti.com](#) 上其他适用条款/TI 产品随附的其他适用条款的约束。TI 提供这些资源并不会扩展或以其他方式更改 TI 针对 TI 产品发布的适用的担保或担保免责声明。

TI 反对并拒绝您可能提出的任何其他或不同的条款。

邮寄地址：Texas Instruments, Post Office Box 655303, Dallas, Texas 75265

Copyright © 2023，德州仪器 (TI) 公司

X-ON Electronics

Largest Supplier of Electrical and Electronic Components

Click to view similar products for [Switching Voltage Regulators](#) category:

Click to view products by [Texas Instruments](#) manufacturer:

Other Similar products are found below :

[FAN53610AUC33X](#) [FAN53611AUC123X](#) [EN6310QA](#) [160215](#) [R3](#) [KE177614](#) [FAN53611AUC12X](#) [MAX809TTR](#) [NCV891234MW50R2G](#)
[AST1S31PUR](#) [NCP81203PMNTXG](#) [NCP81208MNTXG](#) [PCA9412AUKZ](#) [NCP81109GMNTXG](#) [NCP3235MNTXG](#) [NCP81109JMNTXG](#)
[NCP81241MNTXG](#) [NTE7223](#) [NTE7222](#) [NTE7224](#) [L6986FTR](#) [MPQ4481GU-AEC1-P](#) [MP8756GD-P](#) [MPQ2171GJ-P](#) [MPQ2171GJ-AEC1-P](#)
[N JW4153U2-A-TE2](#) [MP2171GJ-P](#) [MP28160GC-Z](#) [XDPE132G5CG000XUMA1](#) [LM60440AQRPKRQ1](#) [MP5461GC-P](#) [IW673-20](#)
[NCV896530MWATXG](#) [MPQ4409GQBE-AEC1-P](#) [S-19903DA-A8T1U7](#) [S-19903CA-A6T8U7](#) [S-19903CA-S8T1U7](#) [S-19902BA-A6T8U7](#)
[S-19902CA-A6T8U7](#) [S-19902AA-A6T8U7](#) [S-19903AA-A6T8U7](#) [S-19902AA-S8T1U7](#) [S-19902BA-A8T1U7](#) [AU8310](#)
[LMR23615QDRRRQ1](#) [LMR33630APAQRNXRQ1](#) [LMR33630APCQRNXRQ1](#) [LMR36503R5RPER](#) [LMR36503RFRPER](#)
[LMR36503RS3QRPERQ1](#)