

# 具有集成电感器的 TPSM8282x 和 TPSM8282xA 1A、2A 和 3A 高效降压转换器 MicroSiP™ 电源模块

## 1 特性

- 1.1mm MicroSiP™ 电源模块
- 符合 CISPR 11 B 类要求
- 效率高达 95%
- 输入电压范围为 2.4V 至 5.5V
- 0.6V 至 4V 可调节输出电压
- 可提供的固定输出电压：1.2V、1.8V、2.5V 和 3.3V
- 工作静态电流为 4  $\mu$ A
- DCS-Control 拓扑
- 可实现轻负载效率的省电模式选项
- 支持 CCM 运行的强制 PWM 选项
- 可实现最低压降的 100% 占空比
- 断续短路保护
- 输出放电
- 具有窗口比较器的电源正常输出
- 集成软启动
- 过热保护
- PSpice 模型可用于：TPSM82821、TPSM82822 和 TPSM82823
- 采用 2.0mm  $\times$  2.5mm  $\times$  1.1mm 10 引脚  $\mu$ SiL 封装
- 12mm<sup>2</sup> 总解决方案尺寸（针对固定输出电压版本）

## 2 应用

- 光学模块
- 机器视觉
- 工业 PC
- PLC
- 有线网络

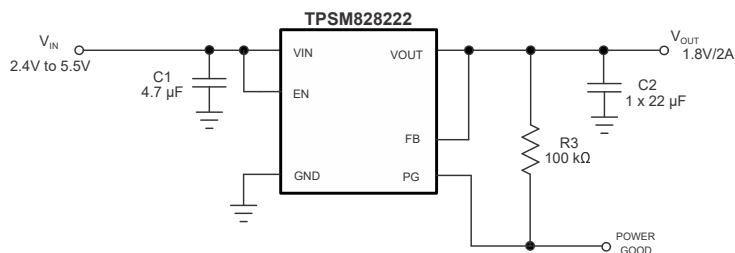

1.8V 输出电压下设置的固定输出应用

## 3 说明

TPSM8282x 器件系列包含 1A、2A 和 3A 降压转换器 MicroSiP™ 电源模块，该电源模块经优化具有小解决方案尺寸和高效率等特性。

该电源模块集成了同步降压转换器和电感器，可简化设计、减少外部元件并节省印刷电路板 (PCB) 面积。

TPSM8282x 具有两种型号。第一种型号可自动进入省电模式，在超轻负载条件下保持高效率，从而延长系统电池的运行时间。第二种型号 TPSM8282xA 可实现强制 PWM 运行，以在所有电流下维持连续导通模式，从而更大程度地缩小输出电压纹波。在 PWM 模式下，转换器运行在 4MHz 的标称开关频率下。

在节能模式下，该器件静态工作电流的典型值为 4 $\mu$ A。通过使用 DCS-Control 拓扑，该器件可实现出色的负载瞬态性能和精确的输出稳压。器件的 EN 和 PG 引脚支持顺序配置，可带来灵活的系统设计。集成的软启动功能降低了输入电源需要提供的浪涌电流。过热保护和断续短路保护功能使得该解决方案稳健且可靠。

### 器件信息

器件型号 <sup>(1)</sup>	封装	封装尺寸 (标称值)
TPSM82821xSILR	$\mu$ SiL (10)	2.0 mm $\times$ 2.5 mm
TPSM82822xSILR		
TPSM82823xSILR		

- (1) 如需了解所有可用封装，请参阅数据表末尾的可订购产品附录。

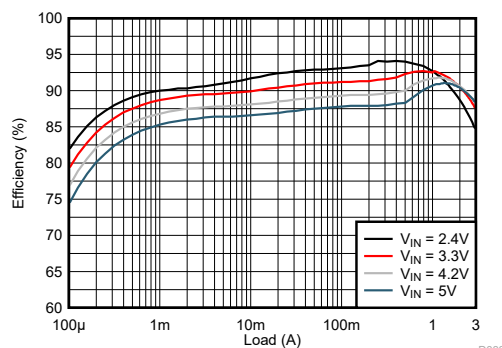

TPSM82823 在 1.8V 输出电压下的效率

D033



## Table of Contents

<b>1 特性</b> .....	1	8.3 Feature Description.....	7
<b>2 应用</b> .....	1	8.4 Device Functional Modes.....	10
<b>3 说明</b> .....	1	<b>9 Application and Implementation</b> .....	11
<b>4 Revision History</b> .....	2	9.1 Application Information.....	11
<b>5 Device Comparison Table</b> .....	3	9.2 Typical Applications.....	11
<b>6 Pin Configuration and Functions</b> .....	3	<b>10 Power Supply Recommendations</b> .....	42
<b>7 Specifications</b> .....	4	<b>11 Layout</b> .....	42
7.1 Absolute Maximum Ratings.....	4	11.1 Layout Guidelines.....	42
7.2 ESD Ratings.....	4	11.2 Layout Example.....	42
7.3 Recommended Operating Conditions.....	4	<b>12 Device and Documentation Support</b> .....	44
7.4 Thermal Information.....	4	12.1 Device Support.....	44
7.5 Electrical Characteristics.....	5	12.2 Documentation Support.....	44
7.6 Typical Characteristics.....	6	12.3 接收文档更新通知.....	44
<b>8 Detailed Description</b> .....	7	12.4 Trademarks.....	44
8.1 Overview.....	7	12.5 Electrostatic Discharge Caution.....	44
8.2 Functional Block Diagram.....	7	12.6 术语表.....	44

## 4 Revision History

注：以前版本的页码可能与当前版本的页码不同

Changes from Revision E (May 2021) to Revision F (November 2021)	Page
• 更新了第一页中的描述以包含 FPWM 器件.....	1
• Added FPWM devices.....	3
• Updated 节 8.3.1 to clarify the addition of the FPWM devices.....	7
• Added application curves for all new FPWM devices.....	14
• Added tape and reel information for FPWM devices.....	45

Changes from Revision D (March 2021) to Revision E (May 2021)	Page
• 发布了 TPSM82823.....	1
• 更新了特性中的第一个要点.....	1
• 向特性部分添加了 PSpice 要点.....	1
• 更新了应用.....	1
• Changed name of the first column of the <i>Device Comparison Table</i> to "Orderable Part Number".....	3
• Fixed slight error in the <i>Functional Block Diagram</i> .....	7
• Added 方程式 2.....	7
• Updated 图 9-1 to have an output capacitor option of $1 \times 22 \mu\text{F}$ .....	11
• Expanded 表 9-1 with more choices of capacitors.....	12
• Added EMI measurement plots to show CISPR compliance.....	14
• Added SOA curves for the TPSM82823.....	33
• Added 节 12.1.2.1.....	44

## 5 Device Comparison Table

ORDERABLE PART NUMBER	OUTPUT VOLTAGE	MODE OF OPERATION	OUTPUT CURRENT
TPSM82821SILR	adjustable	Power save mode	1 A
TPSM828211SILR	1.2 V		
TPSM828212SILR	1.8 V		
TPSM828213SILR	2.5 V		
TPSM828214SILR	3.3 V		
TPSM82821ASILR	adjustable	Forced PWM	2 A
TPSM82822SILR	adjustable	Power save mode	
TPSM828221SILR	1.2 V		
TPSM828222SILR	1.8 V		
TPSM828223SILR	2.5 V		
TPSM828224SILR	3.3 V	Forced PWM	
TPSM82822ASILR	adjustable	Power save mode	3 A
TPSM82823SILR	adjustable	Forced PWM	
TPSM82823ASILR	adjustable	Forced PWM	

## 6 Pin Configuration and Functions



图 6-1. μSiL Package (Top View)

表 6-1. Pin Functions

PIN		I/O	DESCRIPTION
NAME	NO.		
EN	3	I	Device enable pin. To enable the device, this pin needs to be pulled high. Pulling this pin low disables the device. Do not leave floating.
FB	8	I	Feedback pin. This pin must be connected to the center of the output voltage resistor divider. For the fixed output voltage devices, connect this pin directly to the output voltage.
GND	9, 10	PWR	Ground pin
PG	4	O	Power-good open-drain output pin with window comparator. The pullup resistor can be connected to voltages up to 5.5 V. If unused, leave it floating.
VIN	1, 2	PWR	Input voltage pin
VOUT	5, 6, 7	PWR	Output voltage pin

## 7 Specifications

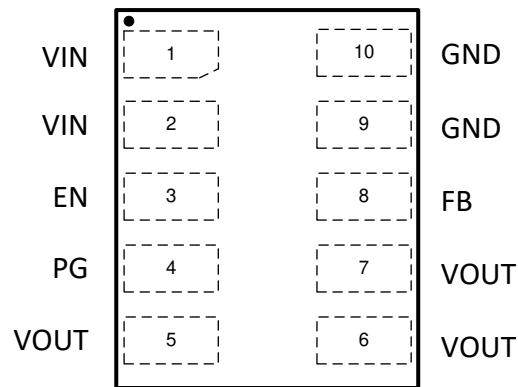
### 7.1 Absolute Maximum Ratings

Over operating junction temperature range (unless otherwise noted) <sup>(1)</sup>

		MIN	MAX	UNIT
Pin voltage	VIN, VOUT, FB, EN, PG <sup>(2)</sup>	- 0.3	6	V
I <sub>SINK_PG</sub>	Sink current at PG pin		1	mA
T <sub>J</sub>	Operating junction temperature	- 40	125	°C
T <sub>stg</sub>	Storage temperature	- 55	125	°C

- Stresses beyond those listed under *Absolute Maximum Ratings* may cause permanent damage to the device. These are stress ratings only, which do not imply functional operation of the device at these or any other conditions beyond those indicated under *Recommended Operating Conditions*. Exposure to absolute-maximum-rated conditions for extended periods may affect device reliability.
- All voltage values are with respect to the network ground terminal.

### 7.2 ESD Ratings

			VALUE	UNIT
V <sub>(ESD)</sub>	Electrostatic discharge	Human body model (HBM), per ANSI/ESDA/JEDEC JS-001, all pins <sup>(1)</sup>	±2000	V
		Charged device model (CDM), per JEDEC specification JESD22-C101, all pins <sup>(2)</sup>	±1000	

- JEDEC document JEP155 states that 500-V HBM allows safe manufacturing with a standard ESD control process.
- JEDEC document JEP157 states that 250-V CDM allows safe manufacturing with a standard ESD control process.

### 7.3 Recommended Operating Conditions

		MIN	MAX	UNIT
V <sub>IN</sub>	Input voltage	2.4	5.5	V
V <sub>OUT</sub>	Output voltage range	0.6	4	V
V <sub>PG</sub>	Pullup resistor voltage		5.5	V
I <sub>OUT</sub>	Output current range, TPSM82821, TPSM82821A <sup>(1)</sup>	0	1	A
	Output current range, TPSM82822, TPSM82822A <sup>(1)</sup>	0	2	
	Output current range, TPSM82823, TPSM82823A <sup>(1)</sup>	0	3	
T <sub>J</sub>	Junction temperature <sup>(1)</sup>	- 40	125	°C

- In applications where high power dissipation and high ambient temperatures are present, the maximum output current must be derated to operate the module within its operating temperature range. See [§ 11.2.1](#).

### 7.4 Thermal Information

THERMAL METRIC <sup>(1)</sup>		TPSM8282x		UNIT
		μ SiL (JEDEC 51-7)	TPSM8282xEVM-080 TPSM8282xAEVM-127	
		10-PINS		
R <sub>θJA</sub>	Junction-to-ambient thermal resistance	92.6	64.3	°C/W
R <sub>θJC(top)</sub>	Junction-to-case (top) thermal resistance	49.6	n/a <sup>(2)</sup>	°C/W
R <sub>θJB</sub>	Junction-to-board thermal resistance	27.7	n/a <sup>(2)</sup>	°C/W
ψ <sub>JT</sub>	Junction-to-top characterization parameter	5.8	4.3	°C/W
ψ <sub>JB</sub>	Junction-to-board characterization parameter	26.9	22.4	°C/W

- For more information about traditional and new thermal metrics, see the [Semiconductor and IC Package Thermal Metrics](#) application report.
- Not applicable to an EVM.

## 7.5 Electrical Characteristics

$T_J = -40^{\circ}\text{C}$  to  $125^{\circ}\text{C}$  and  $V_{IN} = 2.4\text{ V}$  to  $5.5\text{ V}$ . Typical values are at  $T_J = 25^{\circ}\text{C}$  and  $V_{IN} = 5\text{ V}$ , unless otherwise noted.

PARAMETER		TEST CONDITIONS	MIN	TYP	MAX	UNIT
<b>SUPPLY</b>						
$I_Q$	Quiescent current into the VIN	EN = High, no load, device not switching		4	10	$\mu\text{A}$
$I_{SD}$	Shutdown current into the VIN	EN = Low, $T_J = -40^{\circ}\text{C}$ to $85^{\circ}\text{C}$		0.05	0.5	$\mu\text{A}$
$I_Q$	Quiescent current	EN = High, no load, device switching, FPWM devices		8		$\text{mA}$
$V_{UVLO}$	Undervoltage lockout threshold	$V_{IN}$ falling	2.1	2.2	2.3	$\text{V}$
	Undervoltage lockout hysteresis	$V_{IN}$ rising		160		$\text{mV}$
$T_{JSD}$	Thermal shutdown threshold	$T_J$ rising		150		$^{\circ}\text{C}$
	Thermal shutdown hysteresis	$T_J$ falling		20		$^{\circ}\text{C}$
<b>LOGIC INTERFACE EN</b>						
$V_{IH}$	High-level input voltage		1.0			$\text{V}$
$V_{IL}$	Low-level input voltage				0.4	$\text{V}$
$I_{kg(EN)}$	Input leakage current into EN pin	EN = High		0.01	0.1	$\mu\text{A}$
<b>SOFT START, POWER GOOD</b>						
$t_{SS}$	Soft-start time	Time from EN high to 95% of $V_{OUT}$ nominal		1.25		$\text{ms}$
$V_{PGTH}$	Power-good lower threshold	$V_{PG}$ rising, $V_{FB}$ referenced to $V_{FB}$ nominal	94%	96%	98%	
		$V_{PG}$ falling, $V_{FB}$ referenced to $V_{FB}$ nominal	90%	92%	94%	
	Power-good upper threshold	$V_{PG}$ falling, $V_{FB}$ referenced to $V_{FB}$ nominal	103%	105%	107%	
		$V_{PG}$ rising, $V_{FB}$ referenced to $V_{FB}$ nominal	108%	110%	112%	
$V_{PG,OL}$	Low-level output voltage	$I_{sink} = 1\text{ mA}$			0.4	$\text{V}$
$I_{kg(PG)}$	Input leakage current into PG pin	$V_{PG} = 5\text{ V}$		0.01	0.1	$\mu\text{A}$
<b>OUTPUT</b>						
$V_{OUT}$	Output voltage accuracy	TPSM828211, TPSM828221, PWM mode	1.188	1.2	1.212	$\text{V}$
		TPSM828212, TPSM828222, PWM mode	1.782	1.8	1.818	
		TPSM828213, TPSM828223, PWM mode	2.475	2.5	2.525	
		TPSM828214, TPSM828224, PWM mode	3.267	3.3	3.333	
$V_{FB}$	Feedback regulation voltage	PWM mode	594	600	606	$\text{mV}$
$I_{kg(FB)}$	Feedback input leakage current	$V_{FB} = 0.6\text{ V}$		0.01	0.05	$\mu\text{A}$
$I_{DIS}$	Output discharge current	EN = Low, $V_{SW} = 0.4\text{ V}$	75	400		$\text{mA}$
<b>POWER SWITCH</b>						
$R_{DS(on)}$	High-side FET on-resistance			26		$\text{m}\Omega$
	Low-side FET on-resistance			26		$\text{m}\Omega$
$R_{DP}$	Dropout resistance	TPSM82821, TPSM82821A, 100% mode. $V_{IN} = 2.7\text{ V}$ , $T_J = 25^{\circ}\text{C}$		115	145	$\text{m}\Omega$
		TPSM82822, TPSM82822A, 100% mode. $V_{IN} = 2.7\text{ V}$ , $T_J = 25^{\circ}\text{C}$		90	120	
		TPSM82823, TPSM82823A, 100% mode. $V_{IN} = 2.7\text{ V}$ , $T_J = 25^{\circ}\text{C}$		70	95	
$I_{LIMF}$	High-side FET switch current limit	TPSM82821A	1.7	2.1	2.4	$\text{A}$
$I_{LIMF}$	High-side FET switch current limit	TPSM82821	1.75	2.2	2.75	$\text{A}$
		TPSM82822, TPSM82822A	2.7	3.3	3.9	
		TPSM82823, TPSM82823A	3.7	4.3	5.0	
$I_{LIM}$	Low-side FET negative current limit, DC	TPSM82821A/TPSM82822A/TPSM82823A		- 1.6		$\text{A}$
$f_{SW}$	PWM switching frequency	$I_{OUT} = 1\text{ A}$		4		$\text{MHz}$

## 7.6 Typical Characteristics



图 7-1. TPSM82821/TPSM82821A Dropout Resistance



图 7-2. TPSM82822/TPSM82822A Dropout Resistance

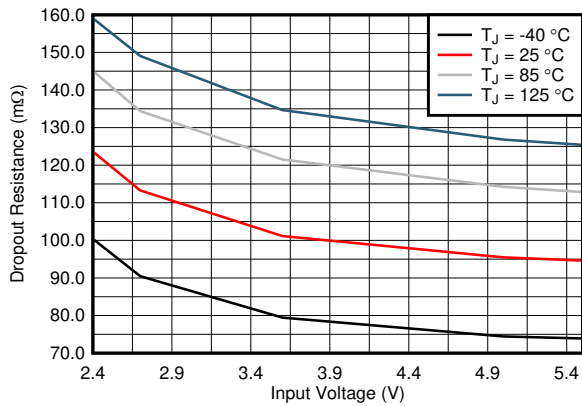

图 7-3. TPSM82823/TPSM82823A Dropout Resistance

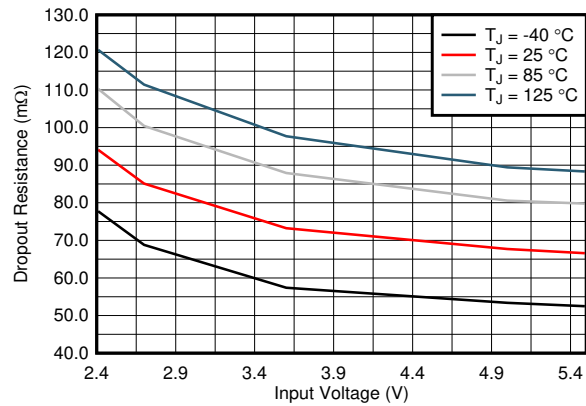

图 7-4. Quiescent Current

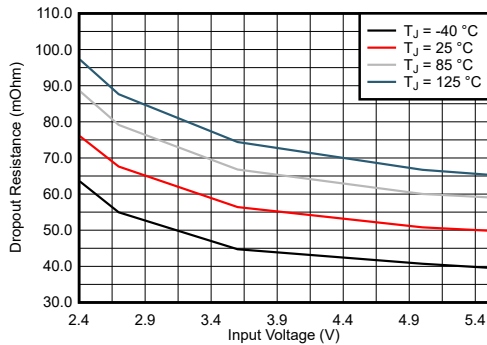

图 7-5. Shutdown Current

## 8 Detailed Description

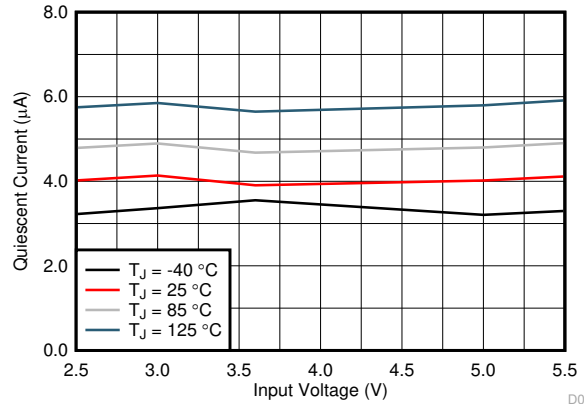
### 8.1 Overview

The TPSM8282x synchronous step-down converter power module is based on DCS-Control (Direct Control with Seamless transition into power save mode). This is an advanced regulation topology that combines the advantages of hysteretic, voltage, and current mode control.

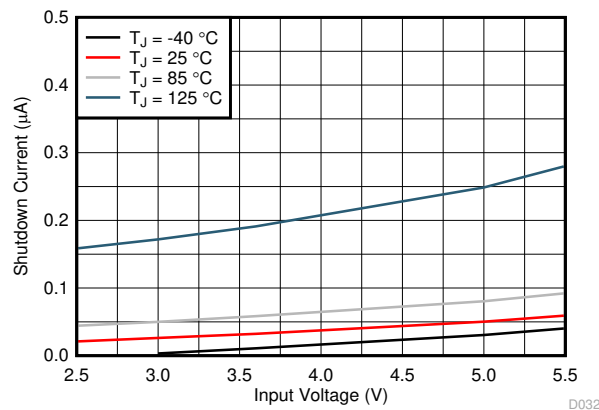
The DCS-Control topology operates in PWM (pulse width modulation) mode for medium to heavy load conditions and in PSM (power save mode) at light load currents. In PWM, the converter operates with its nominal switching frequency of 4 MHz, having a controlled frequency variation over the input voltage range. As the load current decreases, the converter enters power save mode, reducing the switching frequency and minimizing the quiescent current of the IC to achieve high efficiency over the entire load current range. DCS-Control supports both operation modes using a single building block and, therefore, has a seamless transition from PWM to PSM without effects on the output voltage.

The forced PWM versions of this device, the TPSM8282xA, does not enter PSM (power save mode) at light load currents and stays in CCM (continuous conduction mode) regardless of the output current in order to minimize the output ripple.

The TPSM8282x offers excellent DC voltage regulation and load transient regulation, combined with low output voltage ripple, minimizing interference with RF circuits.

### 8.2 Functional Block Diagram

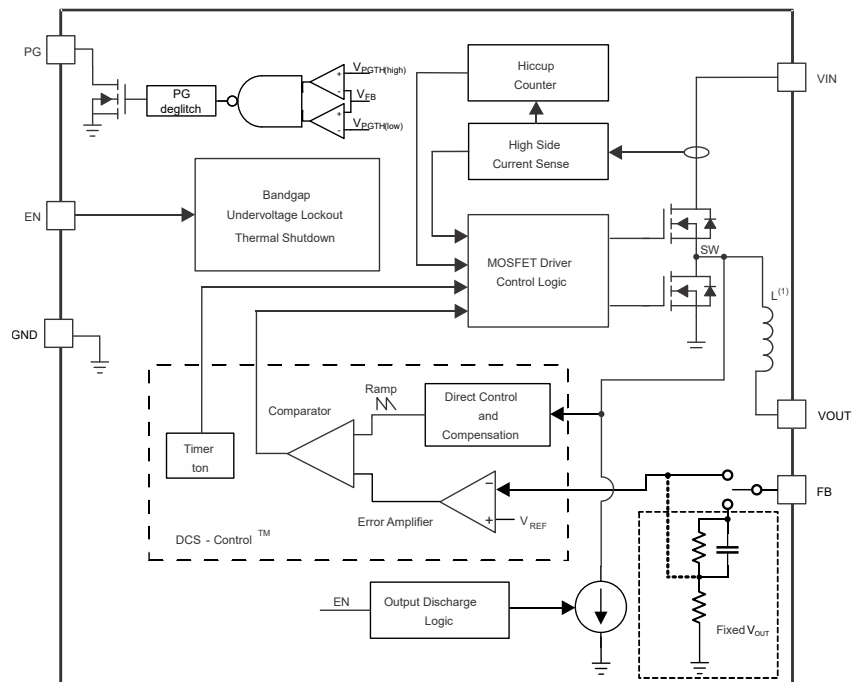

(1) Inductance value is 0.47  $\mu\text{H}$  in TPSM82821/TPSM82821A, 0.24  $\mu\text{H}$  in TPSM82822/TPSM82822A and 0.24  $\mu\text{H}$  in TPSM82823/TPSM82823A.

### 8.3 Feature Description

#### 8.3.1 PWM and PSM Operation

The TPSM8282x includes a fixed on-time ( $t_{ON}$ ) circuitry. This  $t_{ON}$ , in steady-state operation in PWM and PSM modes, is estimated as:

$$t_{ON} = 250\text{ns} \times \frac{V_{OUT}}{V_{IN}} \quad (1)$$

In PWM mode, the TPSM8282x operates with pulse width modulation in continuous conduction mode (CCM) with a  $t_{ON}$  shown in 方程式 1 at medium and heavy load currents. A PWM switching frequency of typically 4 MHz is achieved by this  $t_{ON}$  circuitry.

To maintain high efficiency at light loads, the device enters power save mode seamlessly when the load current decreases. This happens when the load current becomes smaller than half the ripple current of the inductor. The output current at which this occurs can be approximated with the following equation:

$$I_{OUT(\text{PSM-entry})} = \frac{V_{IN} \times t_{ON}}{2} \times \frac{1 - \frac{V_{OUT}}{V_{IN}}}{L} \quad (2)$$

In PSM, the converter operates with a reduced switching frequency and with a minimum quiescent current to maintain high efficiency. The on time in PSM is also based on the same  $t_{ON}$  circuitry. The switching frequency in PSM is estimated as:

$$f_{\text{PSM}} = \frac{2 \times I_{OUT}}{t_{ON}^2 \times \frac{V_{IN}}{V_{OUT}} \times \frac{V_{IN} - V_{OUT}}{L}} \quad (3)$$

In PSM, the output voltage rises slightly above the nominal output voltage in PWM mode. This effect is reduced by increasing the output capacitance.

The forced PWM version of this device, the TPSM8282xA, does not enter PSM (power save mode) at light load currents and stays in CCM (continuous conduction mode) regardless of the output current in order to minimize the output ripple.

### 8.3.2 Low Dropout Operation (100% Duty Cycle)

The device offers a low input-to-output voltage differential by entering 100% duty cycle mode. In this mode, the high-side MOSFET switch is constantly turned on. This is particularly useful in battery-powered applications to achieve longest operation time by taking full advantage of the whole battery voltage range. The minimum input voltage to maintain a minimum output voltage is given by:

$$V_{IN(\text{min})} = V_{OUT(\text{min})} + I_{OUT} \times R_{DP} \quad (4)$$

where

- $R_{DP}$  = Resistance from  $V_{IN}$  to  $V_{OUT}$ , which includes the high-side MOSFET on-resistance and DC resistance of the inductor
- $V_{OUT(\text{min})}$  = Minimum output voltage the load can accept

### 8.3.3 Soft Start-up

After enabling the device, there is a 250- $\mu$ s delay before switching starts. Then, an internal soft start-up circuitry ramps up the output voltage which reaches nominal output voltage during the start-up time of 1 ms. This avoids excessive inrush current and creates a smooth output voltage rise slope. It also prevents excessive voltage drops of primary cells and rechargeable batteries with high internal impedance.

The device is able to start into a pre-biased output capacitor. It starts with the applied bias voltage and ramps the output voltage to its nominal value.



### 8.3.4 Switch Current Limit and Hiccup Short Circuit Protection

The switch current limit prevents the device from high inductor current and from drawing excessive current from the battery or input voltage rail. Excessive current can occur with a shorted or saturated inductor or a heavy load or shorted output circuit condition. If the inductor current reaches the threshold of  $I_{LIMF}$ , the high-side MOSFET is turned off and the low-side MOSFET remains off while the inductor current flows through its body diode and quickly ramps down.

When this switch current limit is triggered 32 times, the device stops switching. The device then automatically starts a new start-up after a typical delay time of 128  $\mu$ s has passed. This is named HICCUP short-circuit protection. The device repeats this mode until the high load condition disappears.

### 8.3.5 Undervoltage Lockout

To avoid mis-operation of the device at low input voltages, undervoltage lockout is implemented that shuts down the device at voltages lower than  $V_{UVLO}$ .

### 8.3.6 Thermal Shutdown

The device goes into thermal shutdown and stops the power stage switching when the junction temperature exceeds  $T_{JSD}$ . When the device temperature falls below the threshold by 20°C, the device returns to normal operation automatically by switching the power stage again.

## 8.4 Device Functional Modes

### 8.4.1 Enable and Disable

The device is enabled by setting the EN pin to a logic high. Accordingly, shutdown mode is forced if the EN pin is pulled low with a shutdown current of typically 50 nA. In shutdown mode, the internal power switches and the entire control circuitry are turned off. An internal switch smoothly discharges the output through the VOUT pin in shutdown mode. Do not leave the EN pin floating.

The typical threshold value of the EN pin is 0.89 V for rising input signal, and 0.62 V for falling input signal.

### 8.4.2 Output Discharge

The purpose of the output discharge function is to ensure a defined down-ramp of the output voltage when the device is disabled and to keep the output voltage close to 0 V. The output discharge is active when the EN pin is set to a logic low and during thermal shutdown. The discharge is not active in UVLO.

### 8.4.3 Power Good Output

The device has a power good output. The PG pin goes high impedance once the FB pin voltage is above 96% and less than 105% of the nominal voltage, and is driven low once the voltage falls below typically 92% or higher than 110% of the nominal voltage. 表 8-1 shows the typical PG pin logic. The PG pin is an open-drain output and is specified to sink up to 1 mA. The power good output requires a pullup resistor connecting to any voltage rail less than 5.5 V. The PG signal can be used for sequencing of multiple rails by connecting to the EN pin of other converters. If not used, the PG pin can be left floating or connected to GND.

表 8-1. Power Good Pin Logic

DEVICE STATE		PG LOGIC STATUS	
		HIGH IMPEDANCE	LOW
Enabled (EN = High)	$0.576 \text{ V} \leq V_{\text{FB}} \leq 0.63 \text{ V}$	✓	
	$V_{\text{FB}} < 0.552 \text{ V}$ or $V_{\text{FB}} > 0.66 \text{ V}$		✓
Shutdown (EN = Low)			✓
UVLO	$0.7 \text{ V} \leq V_{\text{IN}} < V_{\text{UVLO}}$		✓
Thermal Shutdown	$T_{\text{J}} > T_{\text{JSD}}$		✓
Power Supply Removal	$V_{\text{IN}} < 0.7 \text{ V}$	✓	

The PG pin has a 20- $\mu$ s de-glitch time on the falling edge and a 100- $\mu$ s delay before PG goes high. See 图 8-1.



图 8-1. Power Good Transient and De-glitch Behavior

## 9 Application and Implementation

### Note

以下应用部分中的信息不属于 TI 器件规格的范围，TI 不担保其准确性和完整性。TI 的客户应负责确定器件是否适用于其应用。客户应验证并测试其设计，以确保系统功能。

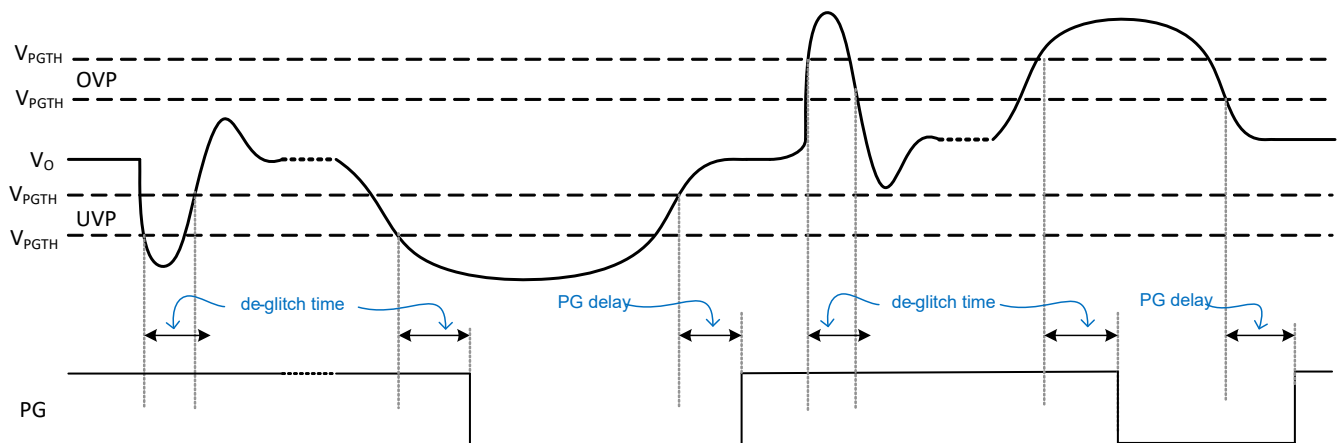
### 9.1 Application Information

The TPSM8282x is a synchronous step-down converter power module. The required power inductor is integrated inside the TPSM8282x. The inductance value is 0.47  $\mu\text{H}$  for the TPSM82821 and TPS82821A, 0.24  $\mu\text{H}$  for the TPSM82822, TPSM82822A, TPSM82823 and TPSM82823A with a  $\pm 20\%$  tolerance. The TPSM82821/TPSM82821A, TPSM82822/TPSM82822A and TPSM82823/TPSM82823A are pin-to-pin and BOM-to-BOM compatible with each other.

### 9.2 Typical Applications

#### 9.2.1 1.8-V Output Application



图 9-1. Adjustable Output Application Set at 1.8-V Output Voltage



图 9-2. Fixed Output Application Set at 1.8-V Output Voltage

### 9.2.1.1 Design Requirements

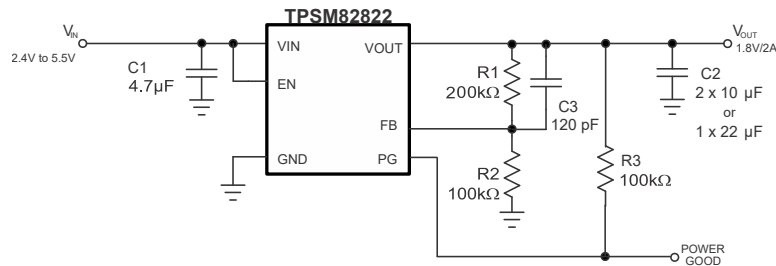
The design guidelines provide a component selection to operate the device within the recommended operating conditions.

Table 9-1 lists the components used for 图 9-1. Table 9-2 lists the components used for Figure 9-2.

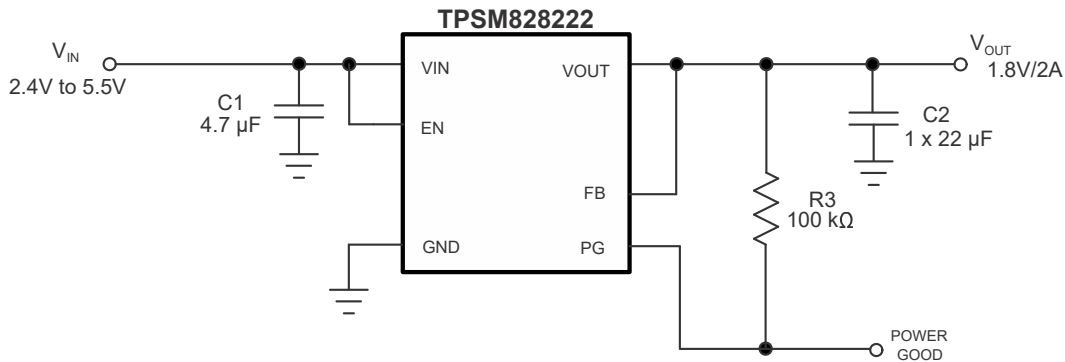
表 9-1. List of Components

REFERENCE	DESCRIPTION	MANUFACTURER
C1	Ceramic capacitor, 4.7 $\mu$ F, 6.3 V, X7R, size (0603), JMK107BB7475MA	Taiyo Yuden
C2	Ceramic capacitor, 2 $\times$ 10 $\mu$ F, 10 V, X7R, size (0603), GRM188Z71A106MA73D	muRata
	Ceramic capacitor, 1 $\times$ 22 $\mu$ F, 6.3 V, X6S, size (0603), JMK107BC6226MA-T	Taiyo Yuden
C3	Ceramic capacitor, 120 pF, 50 V, size (0603), 06035A121JAT2A	AVX
R1	Resistor, 200 k $\Omega$ , 1% accuracy	std
R2	Resistor, 100 k $\Omega$ , 1% accuracy	std
R3	Resistor, 100 k $\Omega$ , 1% accuracy	std

表 9-2. List of Components

REFERENCE	DESCRIPTION	MANUFACTURER
C1	Ceramic capacitor, 4.7 $\mu$ F, 6.3 V, X7R, size (0603), JMK107BB7475MA	Taiyo Yuden
C2	Ceramic capacitor, 22 $\mu$ F, 4 V, X5R, size (0402), AMK105EBJ226MV-F	Taiyo Yuden
R3	Resistor, 100 k $\Omega$ , 1% accuracy	std

### 9.2.1.2 Detailed Design Procedure

#### 9.2.1.2.1 Setting the Output Voltage

Choose resistors R1 and R2 to set the output voltage within a range of 0.6 V to 4 V according to Equation 5. To keep the feedback (FB) net robust from noise, set R2 equal to or lower than 100 k  $\Omega$  to have at least 6  $\mu$ A of current in the voltage divider. Lower values of FB resistors achieve better noise immunity, and lower light load efficiency, as explained in the [Design Considerations for a Resistive Feedback Divider in a DC/DC Converter Technical Brief](#).

$$R1 = R2 \times \left( \frac{V_{OUT}}{V_{FB}} - 1 \right) = R2 \times \left( \frac{V_{OUT}}{0.6V} - 1 \right) \quad (5)$$

For devices with a fixed output voltage, the FB pin must be connected to VOUT. R1, R2 and C3 are not needed. The fixed output voltage devices have an internal feed forward capacitor.

#### 9.2.1.2.2 Feedforward capacitor

A feedforward capacitor (C3) is required in parallel with R1. Equation 6 calculates the C3 value. For the recommended 100-k  $\Omega$  value for R2, a 120-pF feedforward capacitor is used.

$$C3 = \frac{12\mu s}{R2} \quad (6)$$

#### 9.2.1.2.3 Input and Output Capacitor Selection

For the best output and input voltage filtering, ceramic capacitors are required. The input capacitor minimizes input voltage ripple, suppresses input voltage spikes, and provides a stable system rail for the device. A 4.7- $\mu$ F or larger input capacitor is required. The output capacitor value can range from 10  $\mu$ F up to 47  $\mu$ F. The recommended typical output capacitor value is 2  $\times$  10- $\mu$ F or 1  $\times$  22- $\mu$ F with an X5R or X7R dielectric. Values over 47  $\mu$ F can degrade the loop stability of the converter. A feedforward capacitor is required for best transient performance.

Ceramic capacitors have a DC-Bias effect, which has a strong influence on the final effective capacitance. Choose the right capacitor carefully in combination with considering its package size and voltage rating. Ensure that the effective input capacitance is at least 3  $\mu\text{F}$  and the effective output capacitance is at least 5  $\mu\text{F}$ .

### 9.2.1.3 Application Performance Curves

$T_A = 25^\circ\text{C}$ ,  $V_{IN} = 5\text{ V}$ ,  $V_{OUT} = 1.8\text{ V}$ , BOM = 表 9-1 unless otherwise noted.

#### 9.2.1.3.1 TPSM82821 Performance Curves



图 9-3. Efficiency



图 9-4. Efficiency

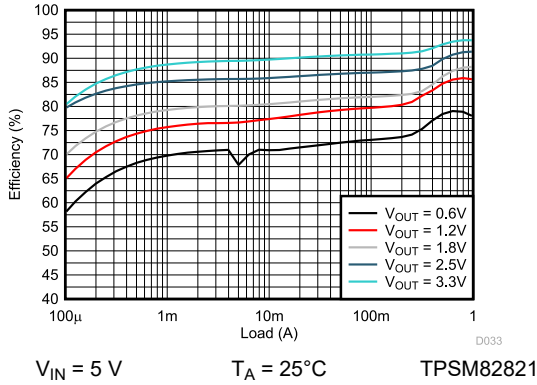

图 9-5. Efficiency

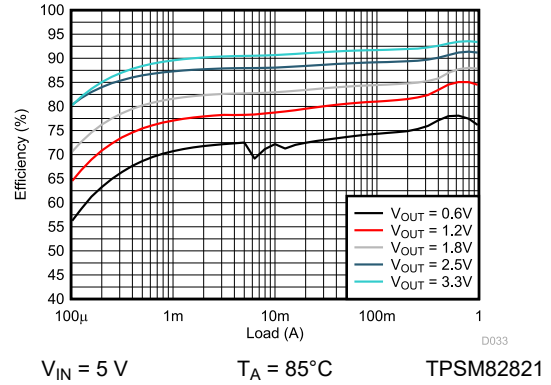

图 9-6. Efficiency

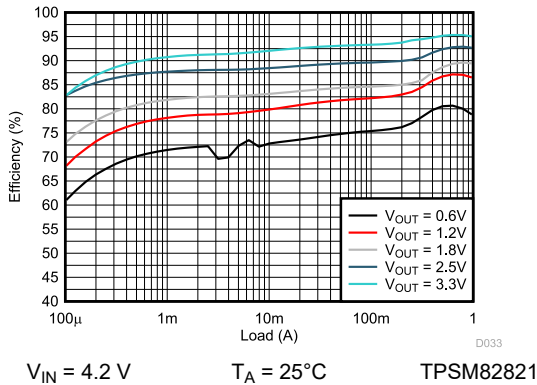

图 9-7. Efficiency

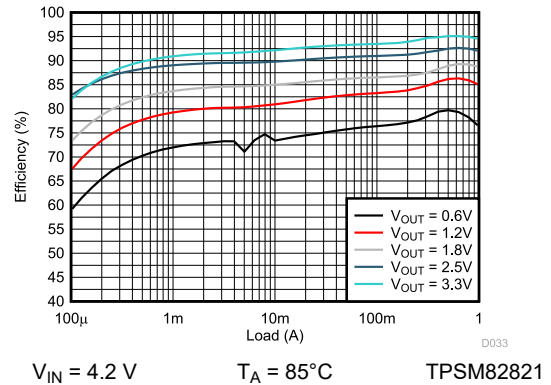

图 9-8. Efficiency

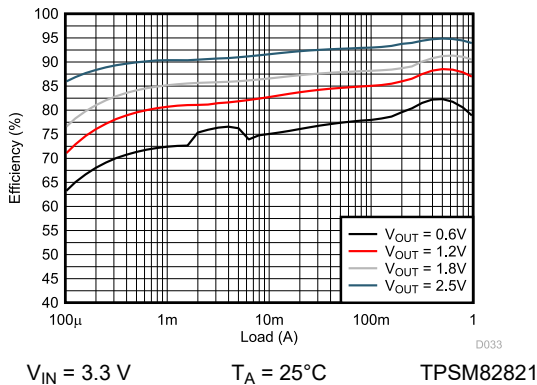

图 9-9. Efficiency

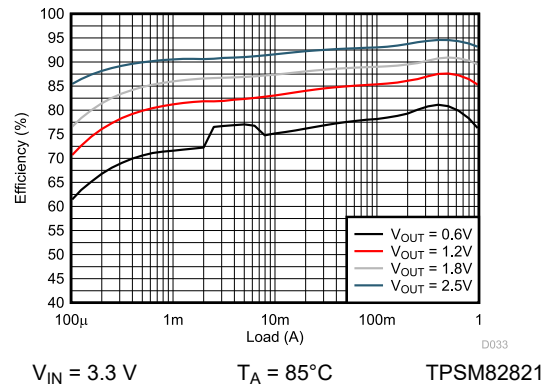

图 9-10. Efficiency

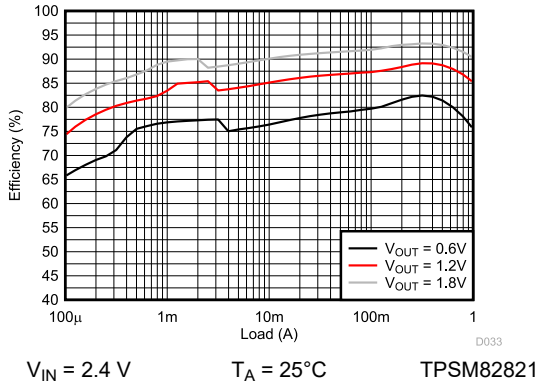

图 9-11. Safe Operating Area

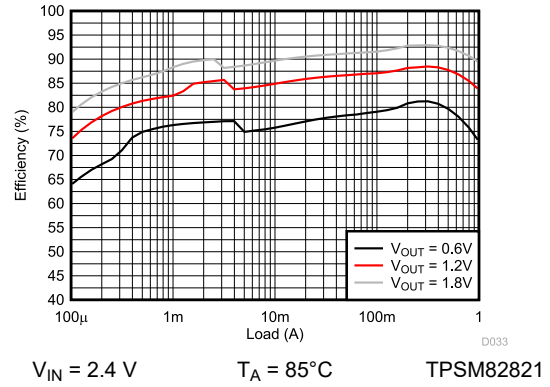

图 9-12. Safe Operating Area

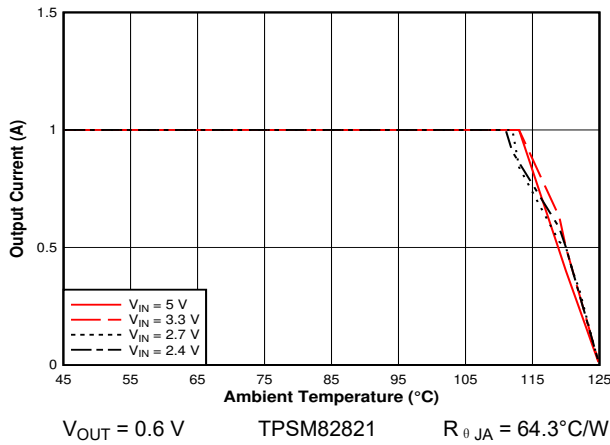

图 9-13. Safe Operating Area

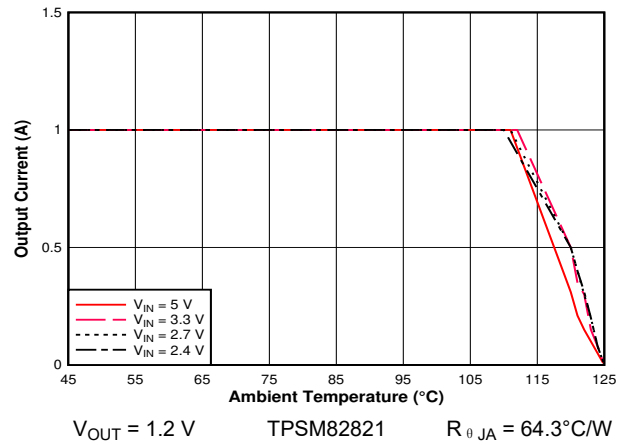

图 9-14. Safe Operating Area

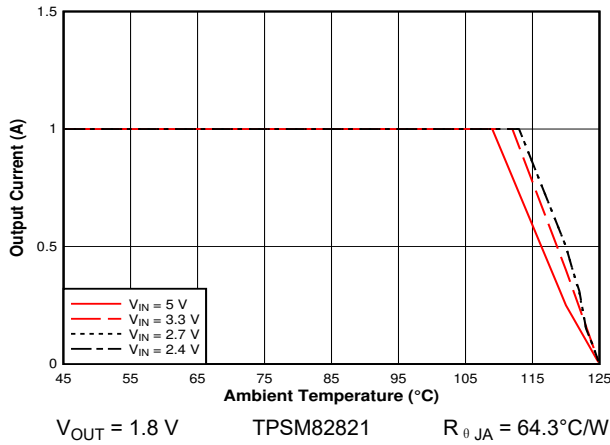

$V_{OUT} = 3.3\text{ V}$     TPSM82821     $R_{\theta JA} = 64.3^{\circ}\text{C/W}$

图 9-15. Safe Operating Area

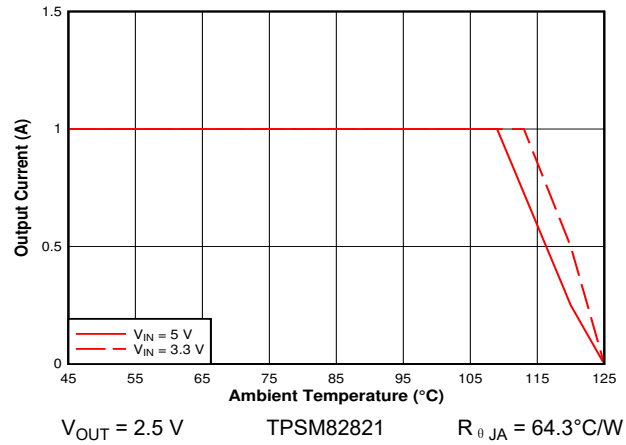
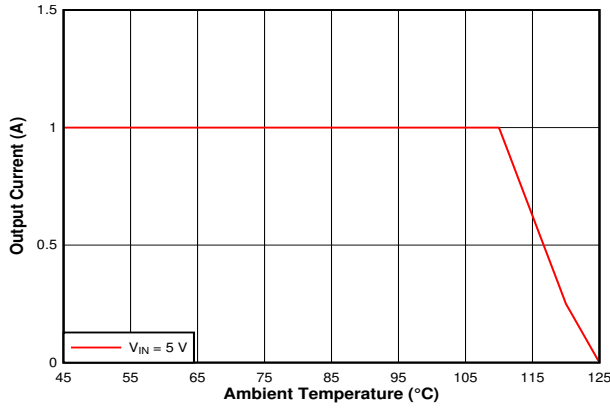

图 9-16. Load Regulation



图 9-17. Load Regulation

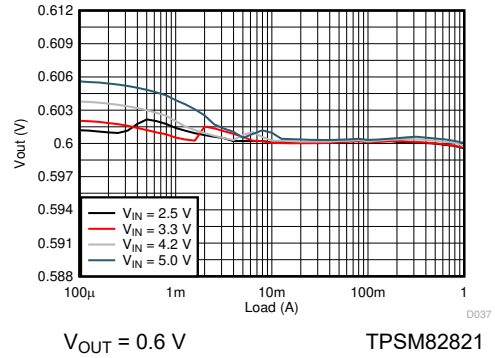

图 9-18. Load Regulation

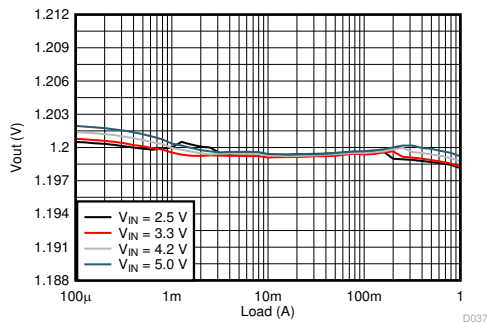

图 9-19. Load Regulation

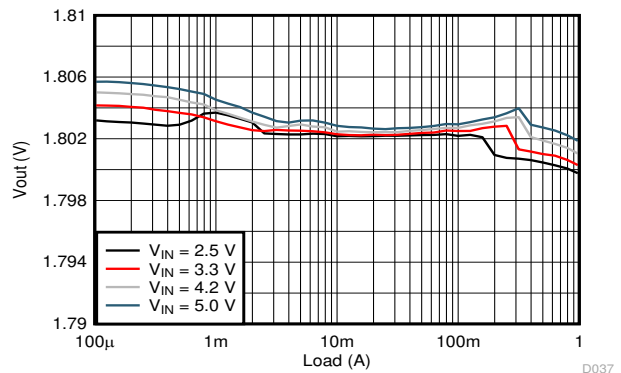

图 9-20. Load Regulation



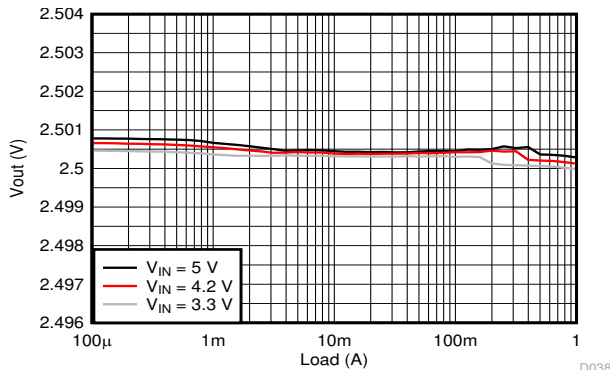

图 9-21. Line Regulation

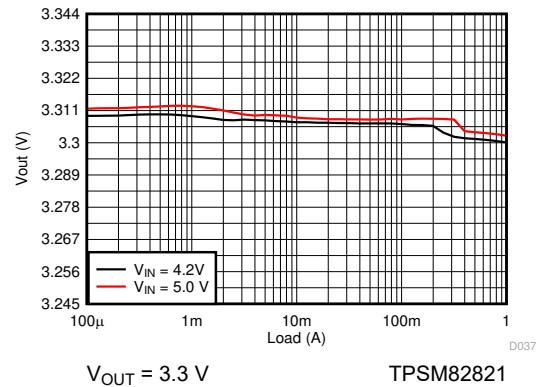

图 9-22. Line Regulation

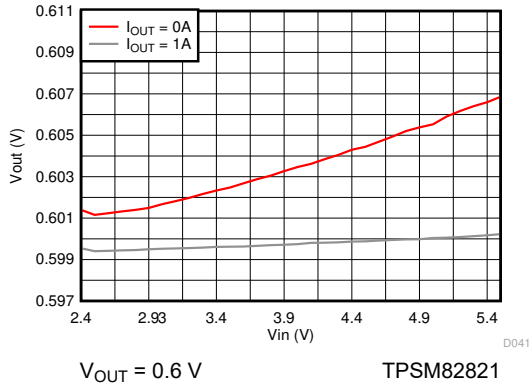

图 9-23. Line Regulation

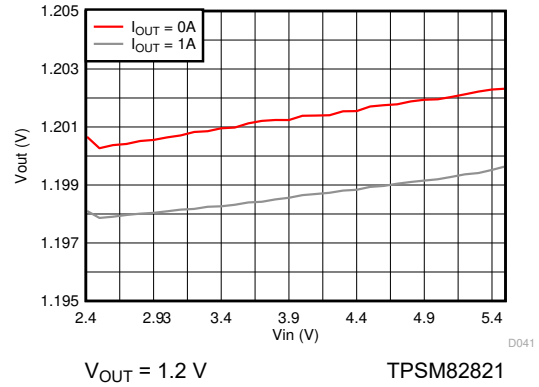

图 9-24. Line Regulation

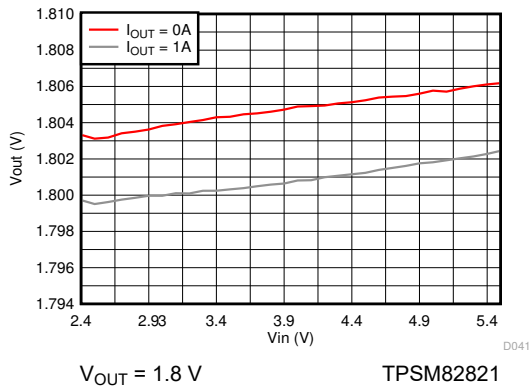

图 9-25. Load Transient

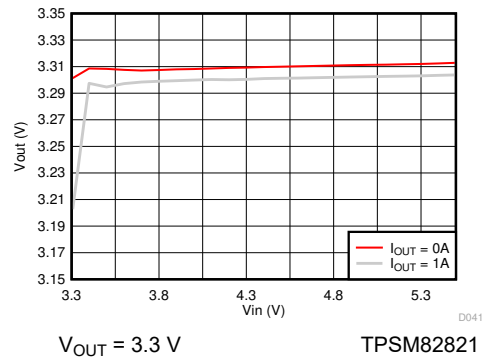

图 9-26. Load Transient

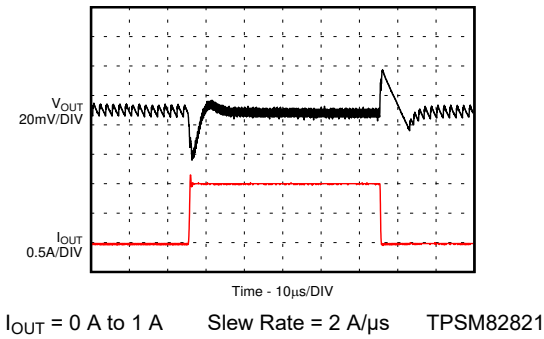

Horizontal - QPK  
Vertical - QPK  
CISPR 11 Group 1 Class B 3m Limit

$R_{LOAD} = 2.2 \Omega$ ,  $V_{IN} = 5.5 \text{ V}$  (battery supply),  $V_{OUT} = 1.8 \text{ V}$ ,  
tested on TPSM82821EVM-080

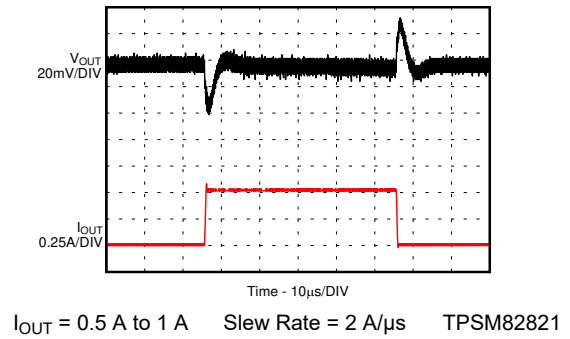
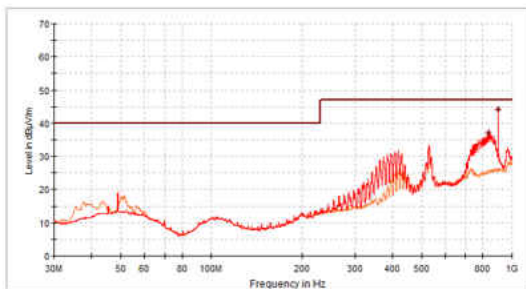
**图 9-27. TPSM82821 Radiated Emissions**

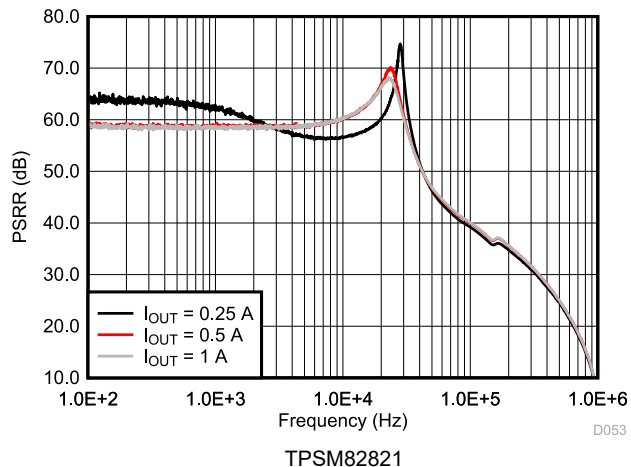

**图 9-28. Power Supply Rejection Ratio (PSRR)**

**9.2.1.3.2 TPSM82821A Performance Curves**

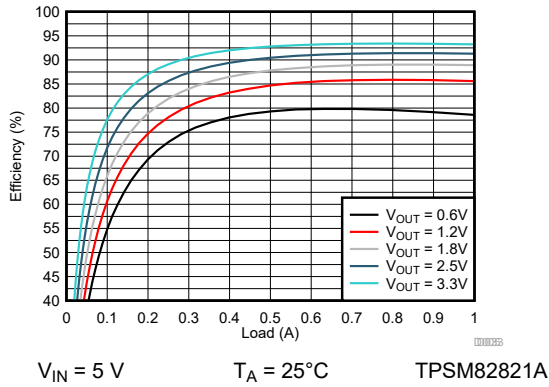

**图 9-29. Efficiency**

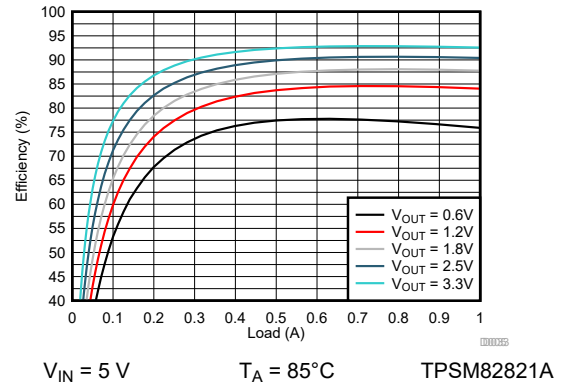

**图 9-30. Efficiency**

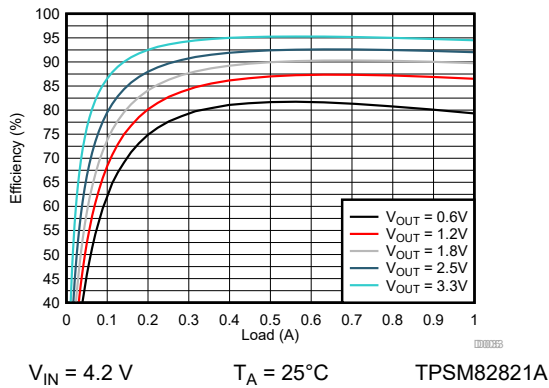

**图 9-31. Efficiency**

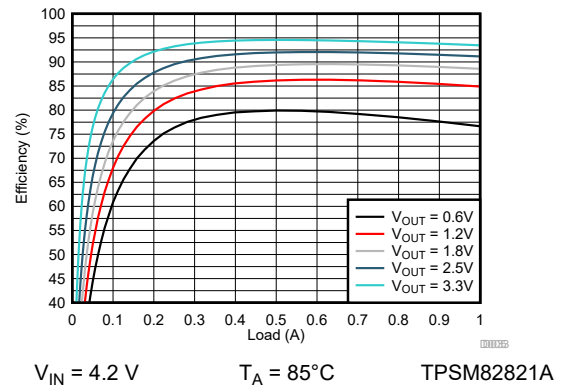

**图 9-32. Efficiency**

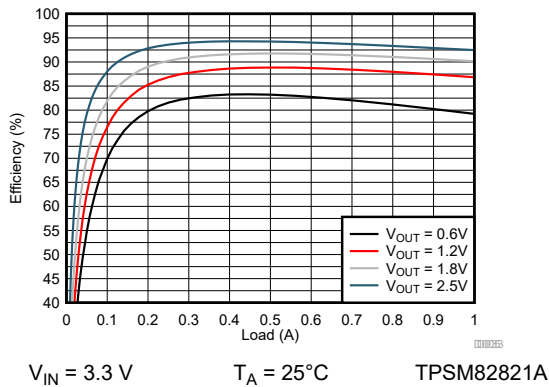

**图 9-33. Efficiency**

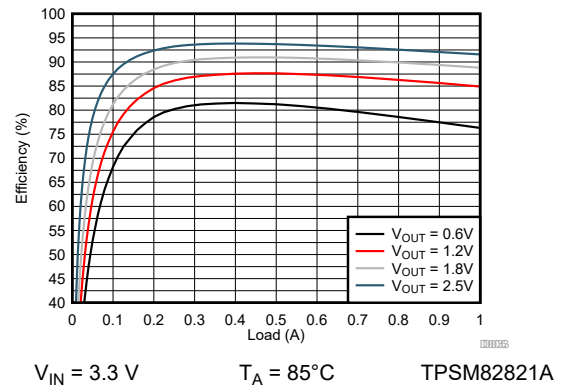

**图 9-34. Efficiency**

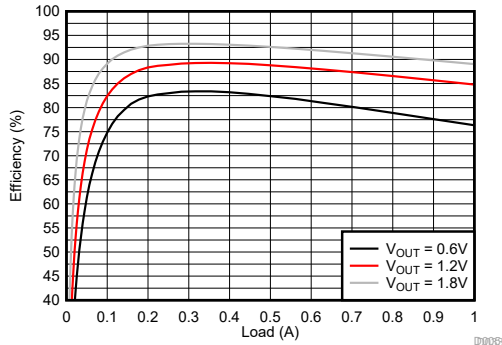

$V_{IN} = 2.4\text{ V}$        $T_A = 25^\circ\text{C}$       TPSM82821A

**图 9-35. Efficiency**

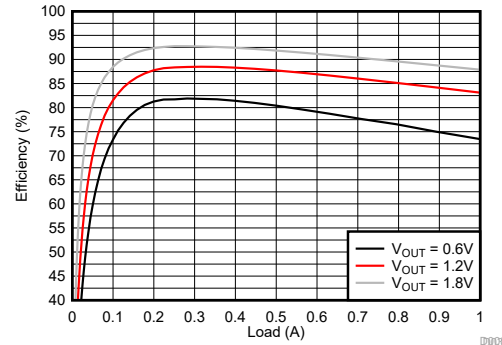

$V_{IN} = 2.4\text{ V}$        $T_A = 85^\circ\text{C}$       TPSM82821A

**图 9-36. Efficiency**

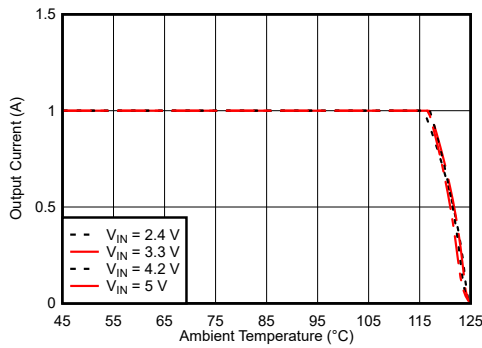

$V_{OUT} = 0.6\text{ V}$       TPSM82821A       $R_{\theta JA} = 64.3^\circ\text{C/W}$

**图 9-37. Safe Operating Area**

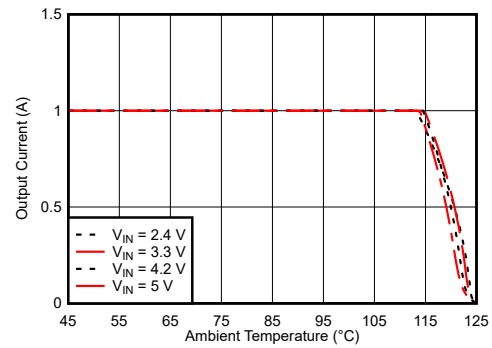

$V_{OUT} = 1.2\text{ V}$       TPSM82821A       $R_{\theta JA} = 64.3^\circ\text{C/W}$

**图 9-38. Safe Operating Area**

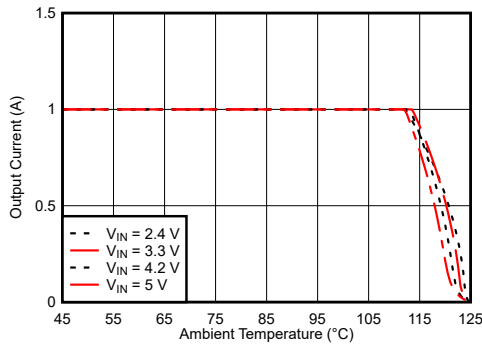

$V_{OUT} = 1.8\text{ V}$       TPSM82821A       $R_{\theta JA} = 64.3^\circ\text{C/W}$

**图 9-39. Safe Operating Area**

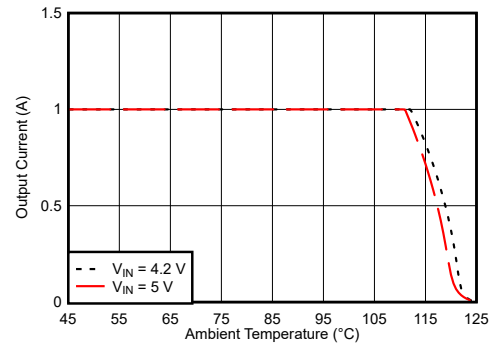

$V_{OUT} = 2.5\text{ V}$       TPSM82821A       $R_{\theta JA} = 64.3^\circ\text{C/W}$

**图 9-40. Safe Operating Area**



图 9-41. Safe Operating Area



图 9-42. Load Regulation

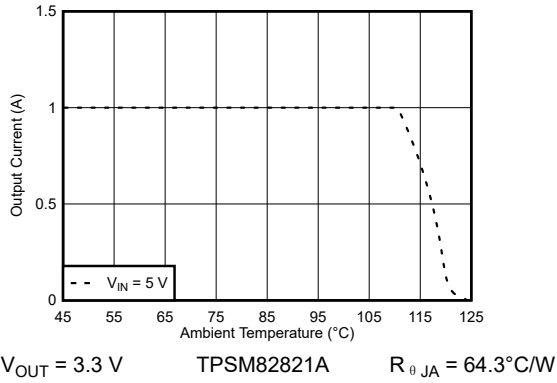

图 9-43. Load Regulation

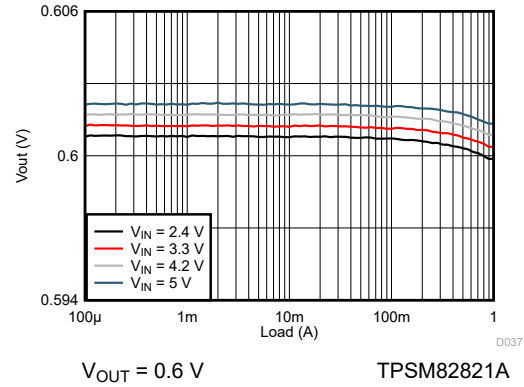

图 9-44. Load Regulation

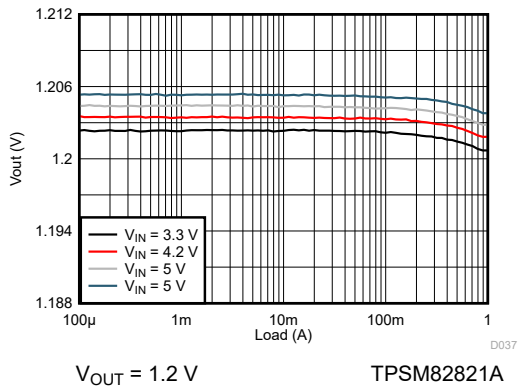

图 9-45. Load Regulation

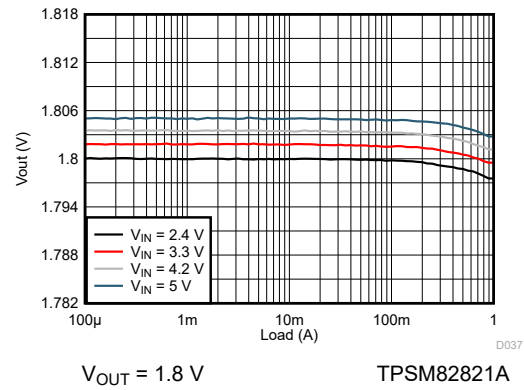

图 9-46. Load Regulation

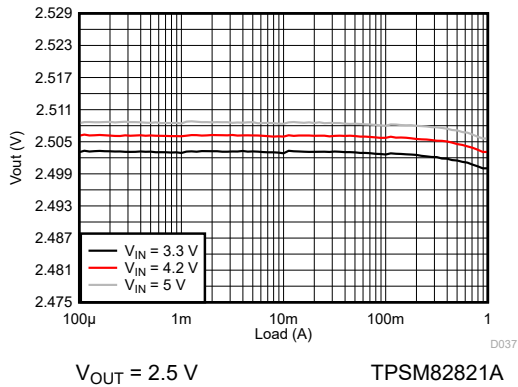

$I_{OUT} = 1\text{ A}$  TPSM82821A

**图 9-47. Output Ripple in PWM Mode**

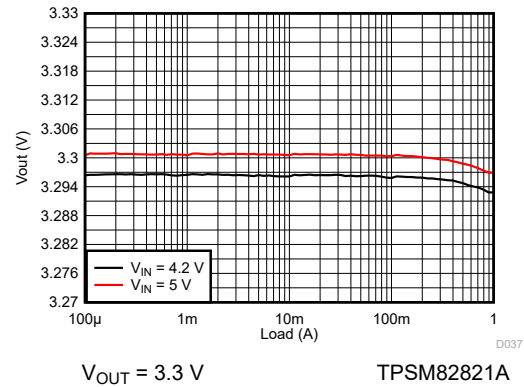
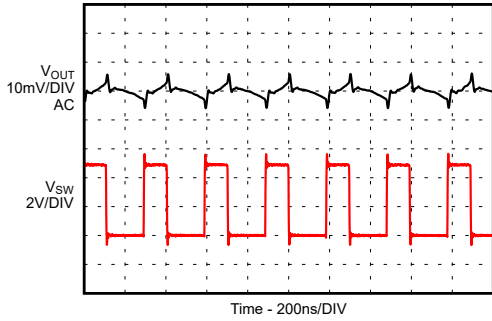
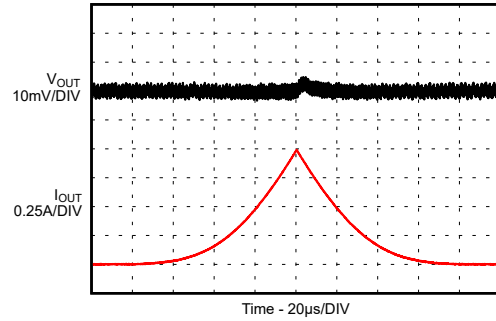

$I_{OUT} = 0\text{ mA to }1\text{ A}$  TPSM82821A

**图 9-48. Load Sweep**

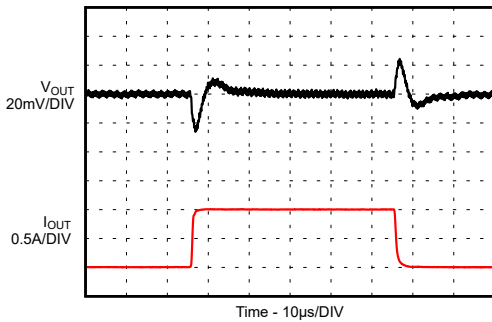

$I_{OUT} = 0\text{ A to }1\text{ A}$  Slew Rate =  $2\text{ A}/\mu\text{s}$  TPSM82821A

**图 9-49. Load Transient**

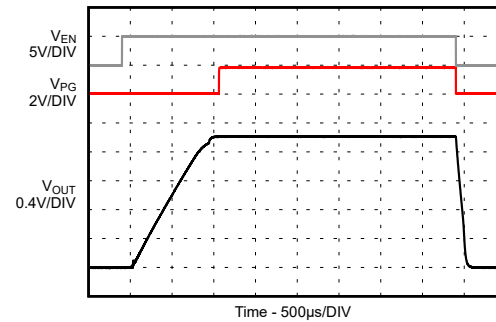

$I_{OUT} = \text{no load}$  TPSM82821A

**图 9-50. Start-up / Shutdown without Load**

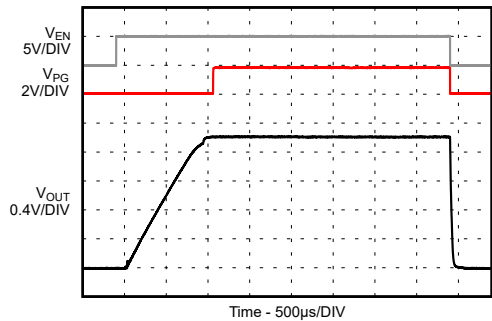

$I_{OUT} = 1\text{ A}$  TPSM82821A

**图 9-51. Start-up / Shutdown with Resistive Load**

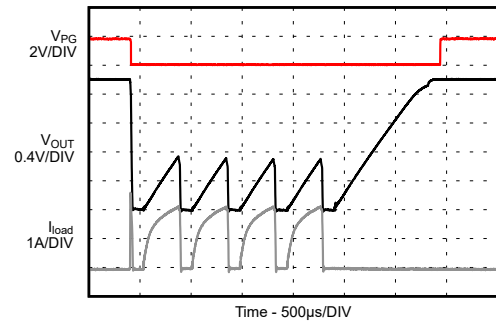

TPSM82821A

**图 9-52. Short Circuit, HICCUP Protection Entry / Exit**

**9.2.1.3.3 TPSM82822 Performance Curves**

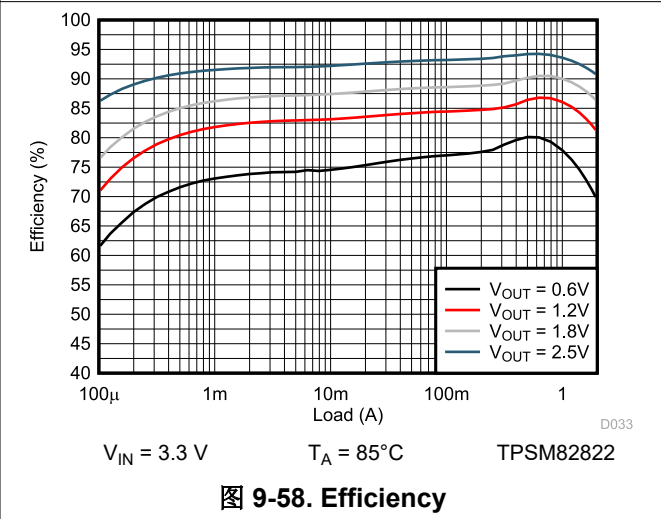
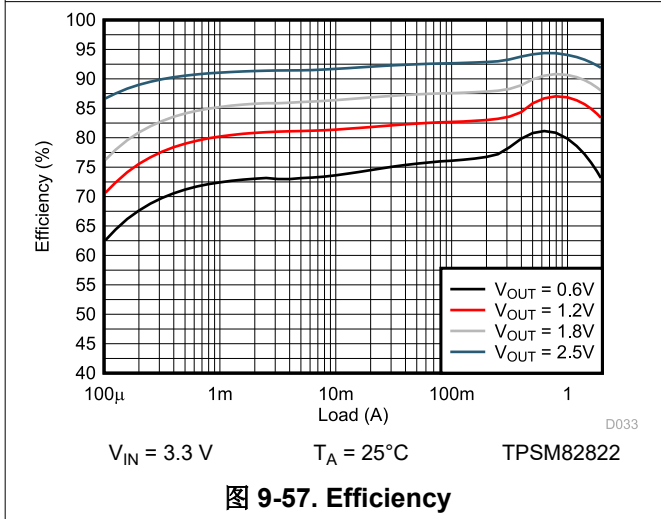
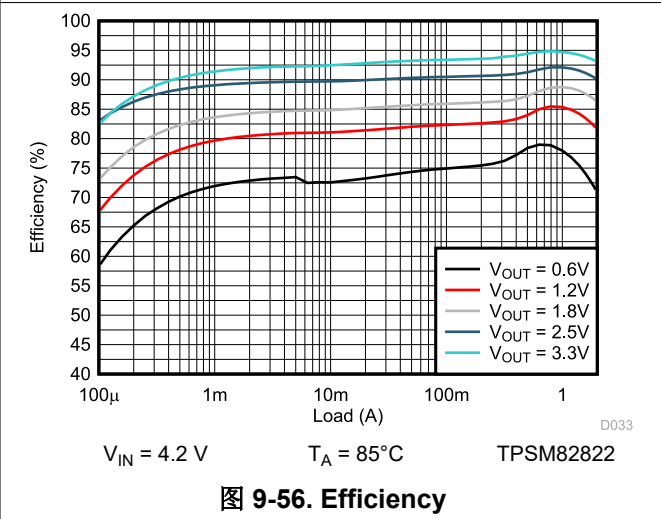
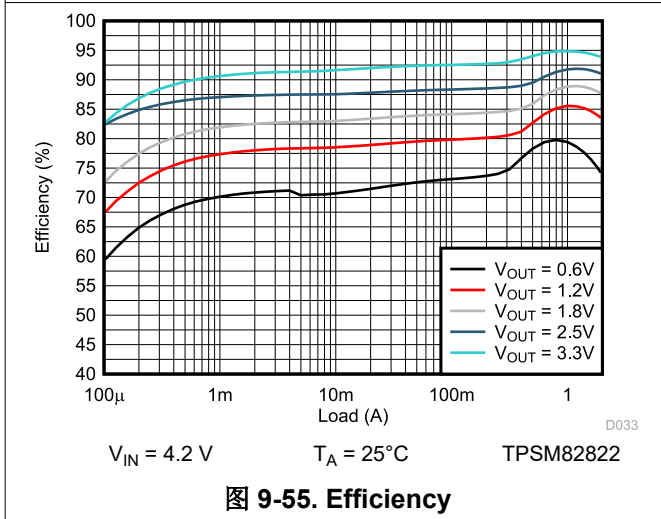
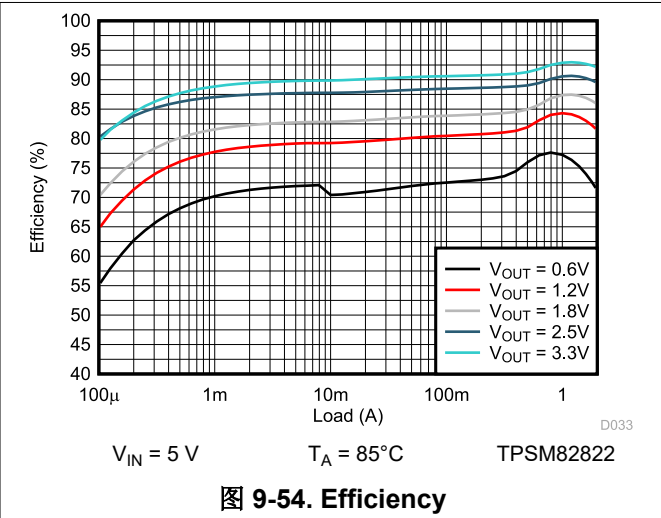
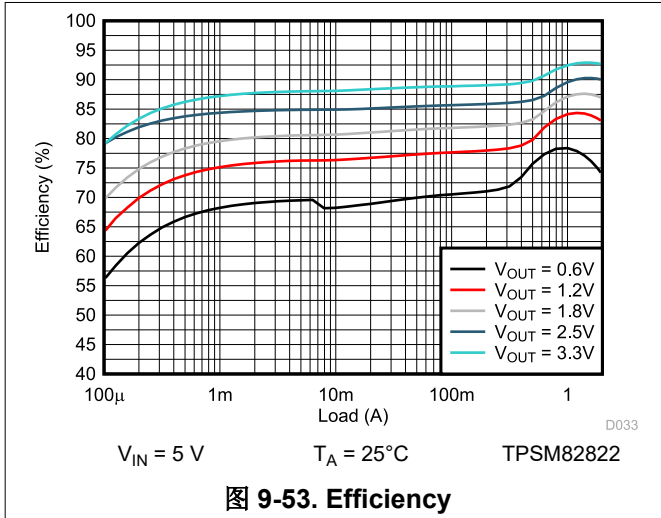



图 9-59. Efficiency



图 9-60. Efficiency

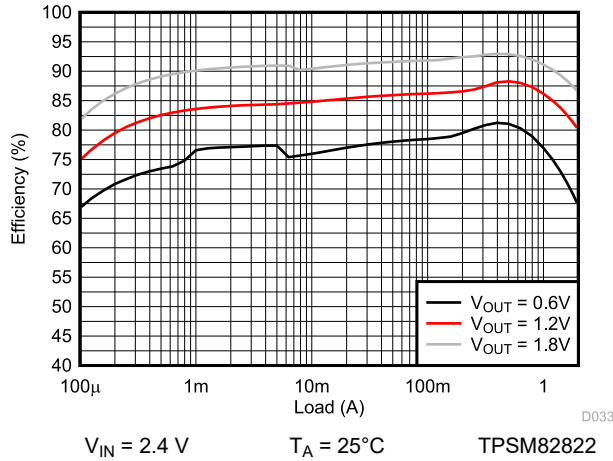

图 9-61. Safe Operating Area

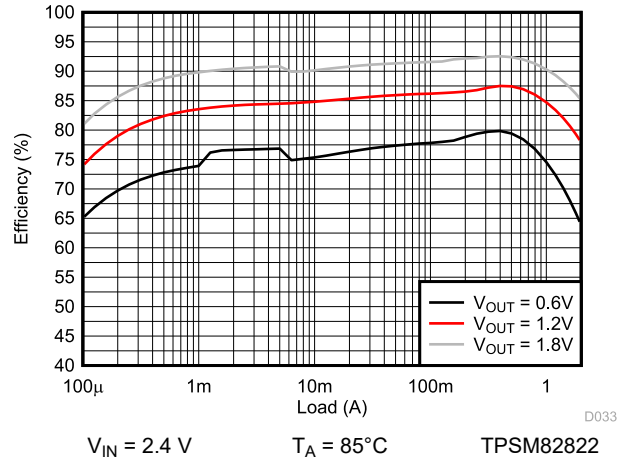

图 9-62. Safe Operating Area

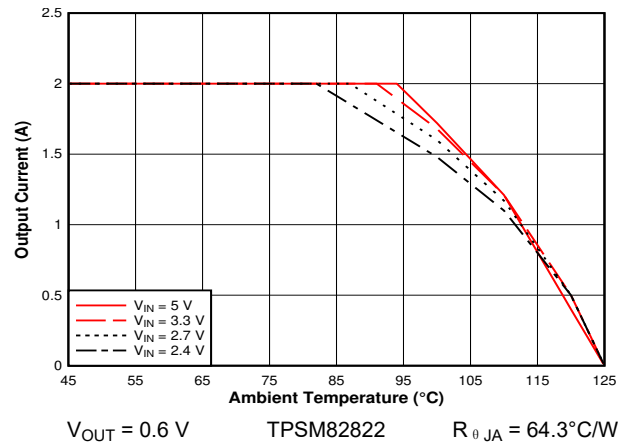

图 9-63. Safe Operating Area

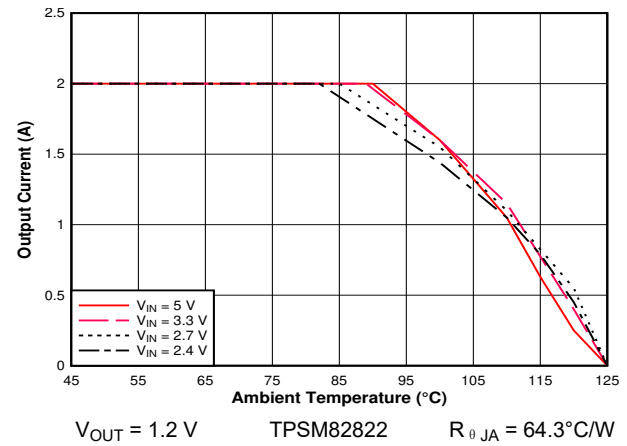

图 9-64. Safe Operating Area



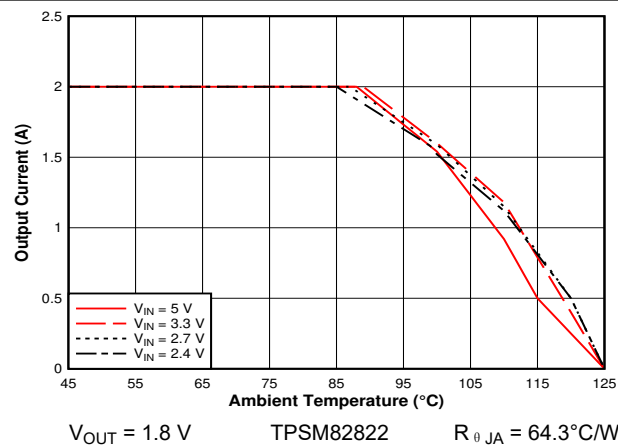

图 9-65. Safe Operating Area

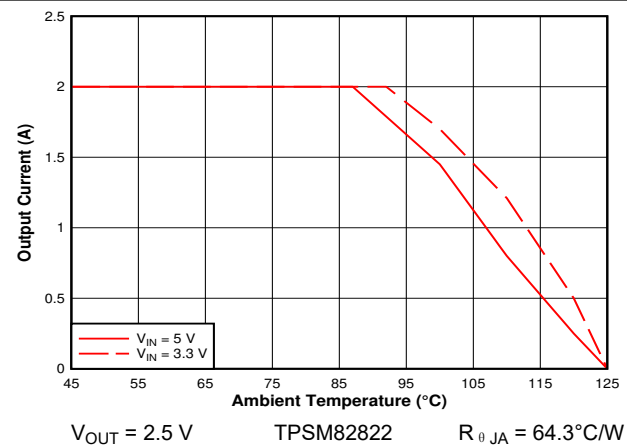

图 9-66. Load Regulation

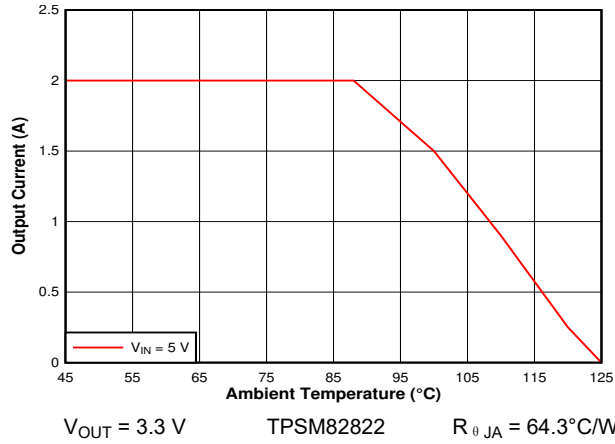

图 9-67. Load Regulation

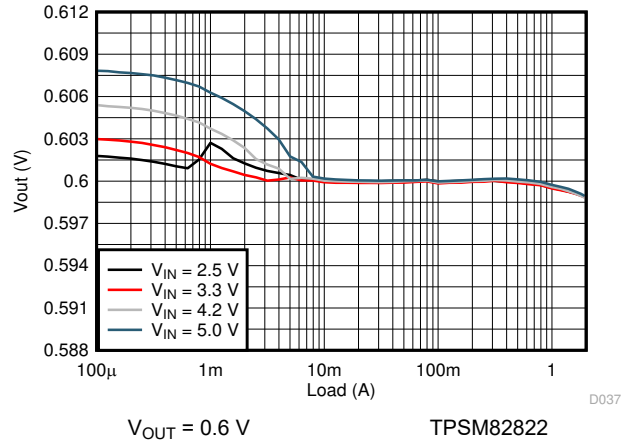

图 9-68. Load Regulation

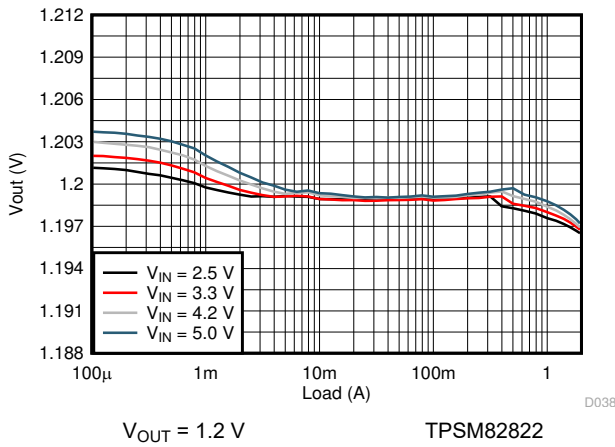

图 9-69. Load Regulation

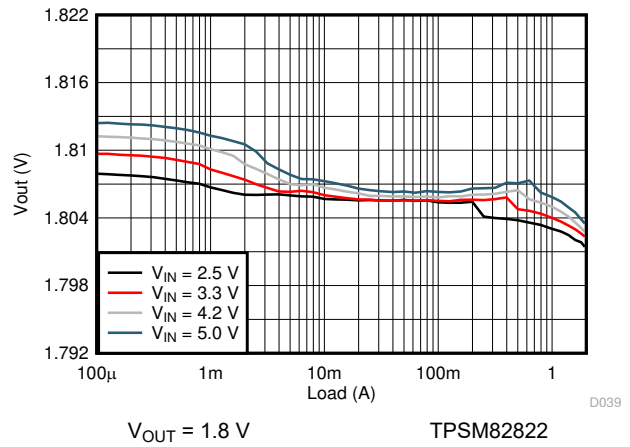

图 9-70. Load Regulation

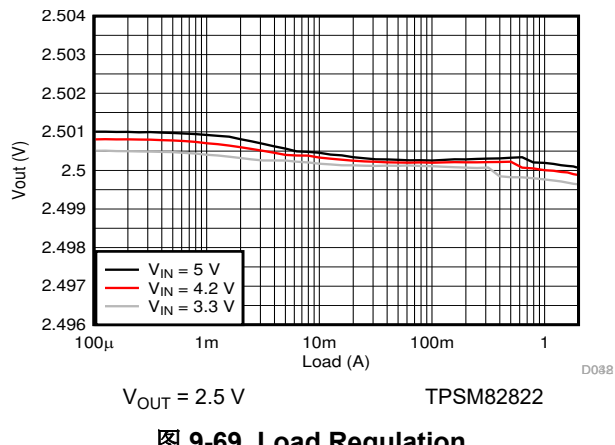

$V_{OUT} = 0.6\text{ V}$  TPSM82822

图 9-71. Line Regulation

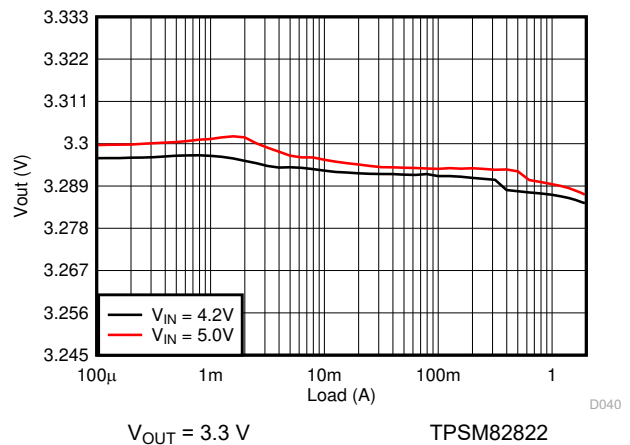
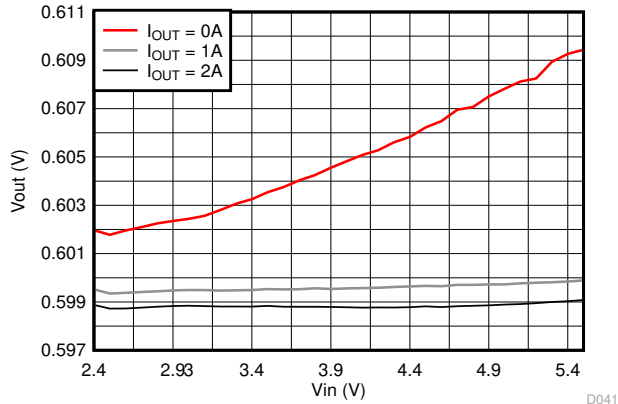
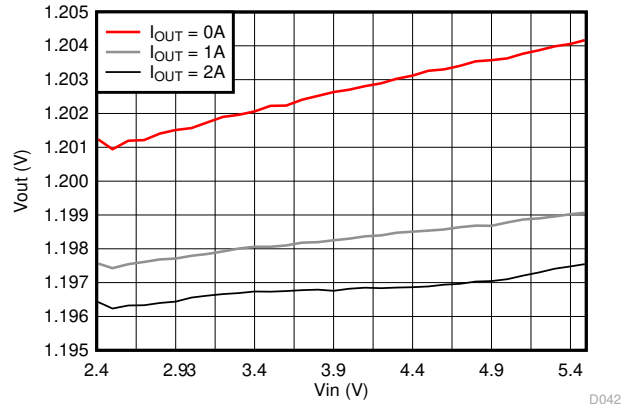

$V_{OUT} = 1.2\text{ V}$  TPSM82822

图 9-72. Line Regulation

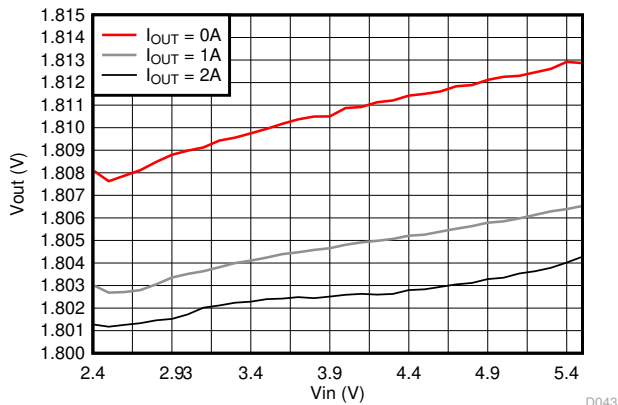

$V_{OUT} = 1.8\text{ V}$  TPSM82822

图 9-73. Line Regulation

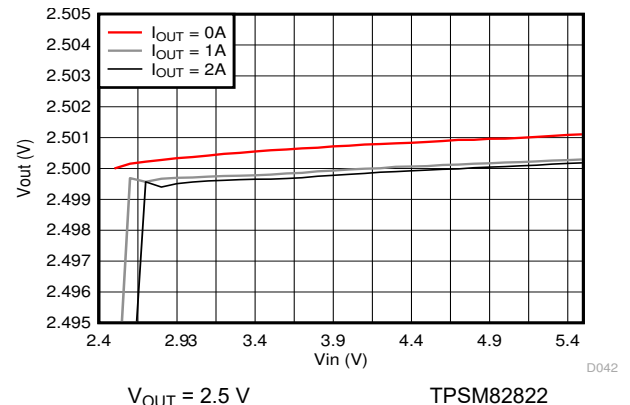

$V_{OUT} = 2.5\text{ V}$  TPSM82822

图 9-74. Line Regulation

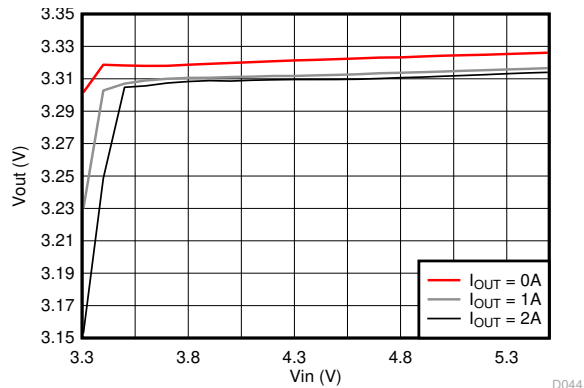

$V_{OUT} = 3.3\text{ V}$  TPSM82822

图 9-75. Line Regulation

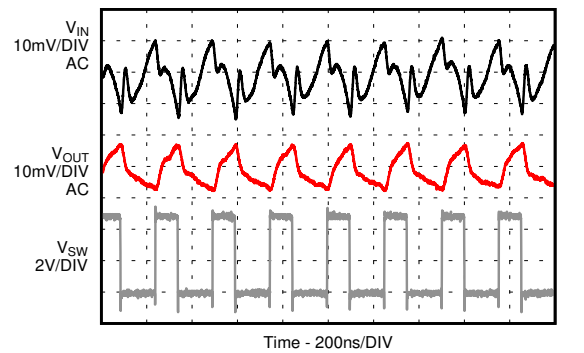

$I_{OUT} = 2\text{ A}$  TPSM82822

图 9-76. Input and Output Ripple in PWM Mode



图 9-77. Input and Output Ripple in PSM Mode



图 9-78. Load Sweep

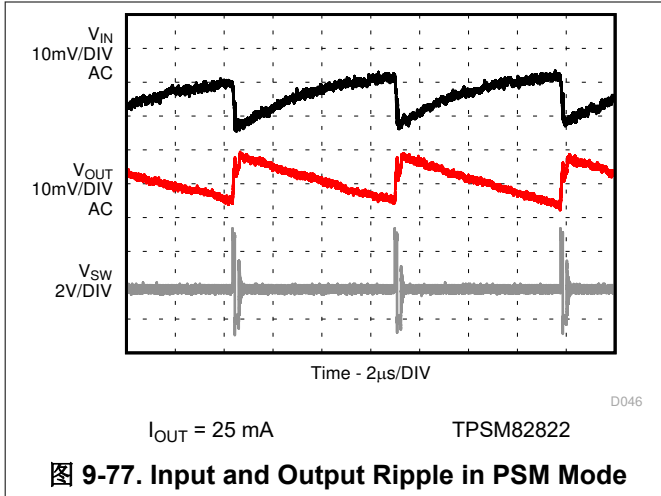

图 9-79. Load Transient

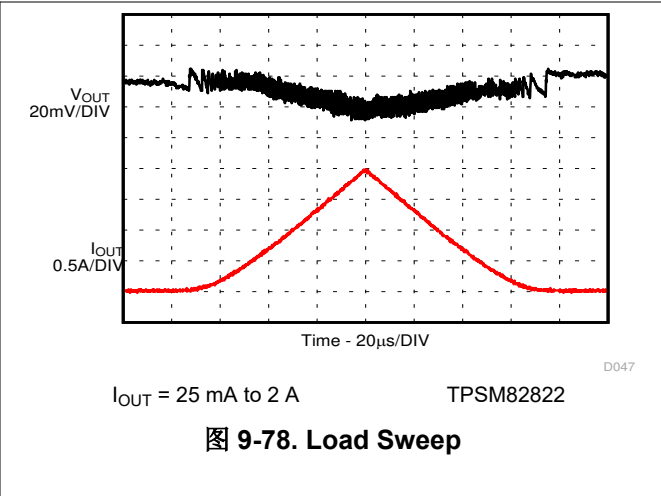

图 9-80. Load Transient

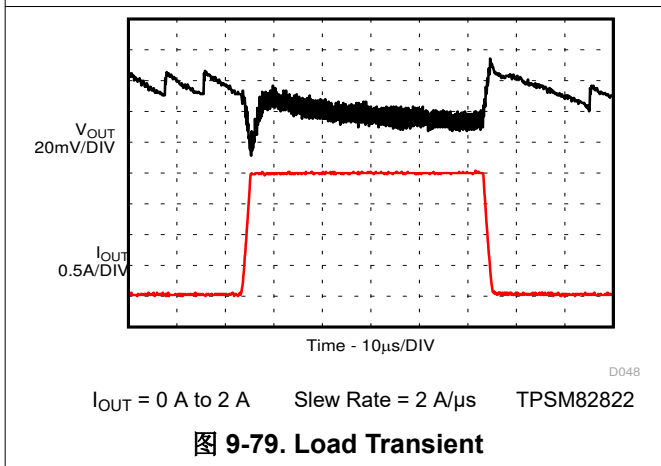

图 9-81. Start-up / Shutdown without Load

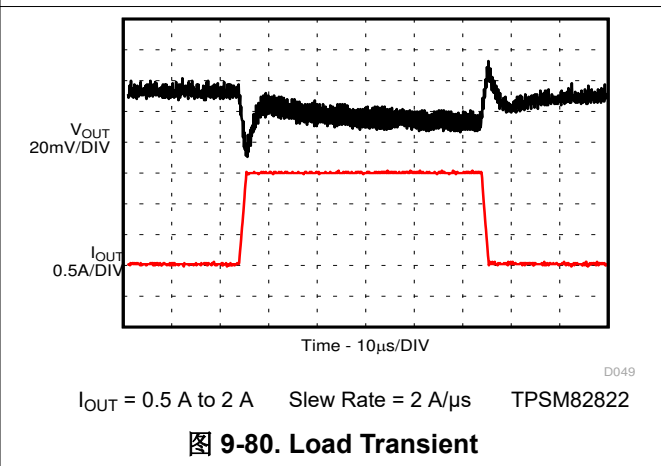

图 9-82. Start-up / Shutdown with Resistive Load

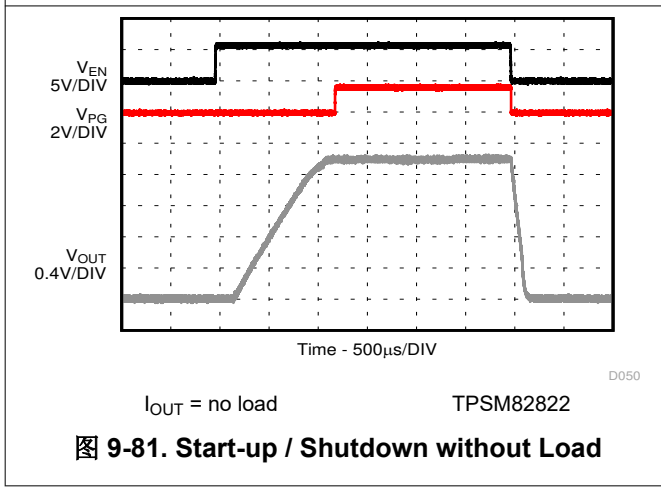

Time - 500µs/DIV  
 D052  
 TPSM82822

**图 9-83. Short Circuit, HICUP Protection Entry / Exit**

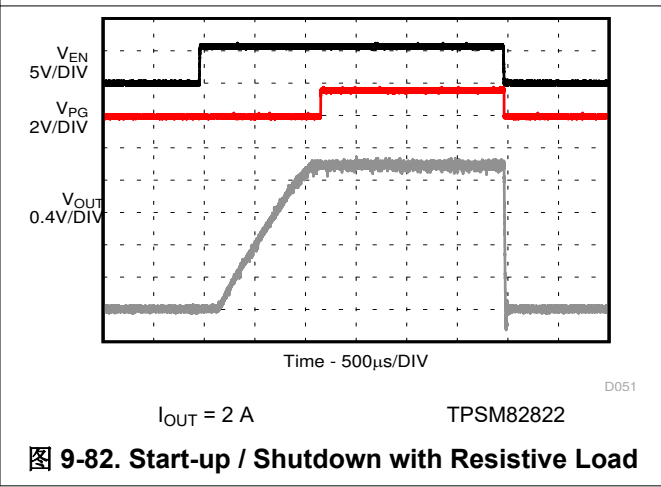
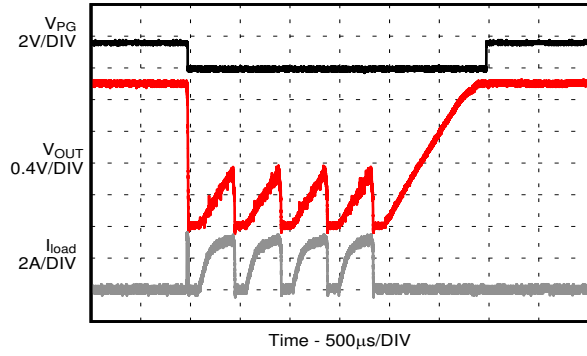
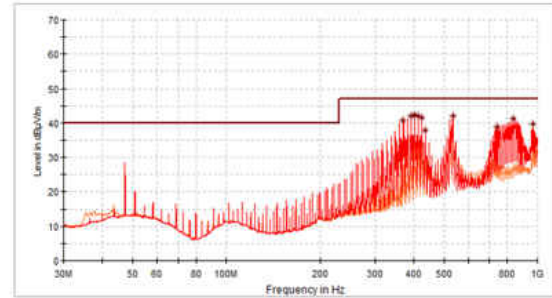

Horizontal - QPK  
 Vertical - QPK  
 CISPR 11 Group 1 Class B 3m Limit  
 $R_{LOAD} = 1 \Omega$ ,  $V_{IN} = 5.5 \text{ V}$  (battery supply),  $V_{OUT} = 1.8 \text{ V}$ ,  
 tested on TPSM82822EVM-080

**图 9-84. TPSM82822 Radiated Emissions**

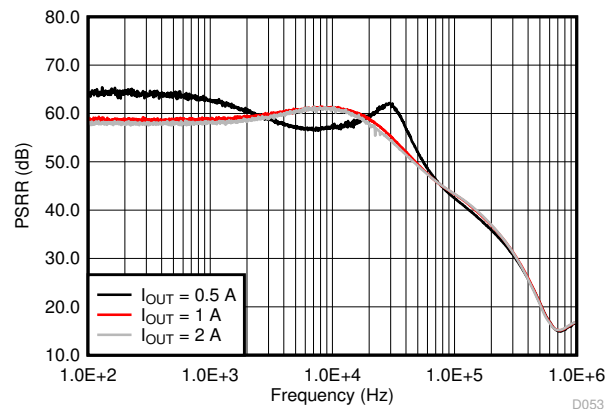

D053  
 TPSM82822

**图 9-85. Power Supply Rejection Ratio (PSRR)**

9.2.1.3.4 TPSM82822A Performance Curves



图 9-86. Efficiency



图 9-87. Efficiency

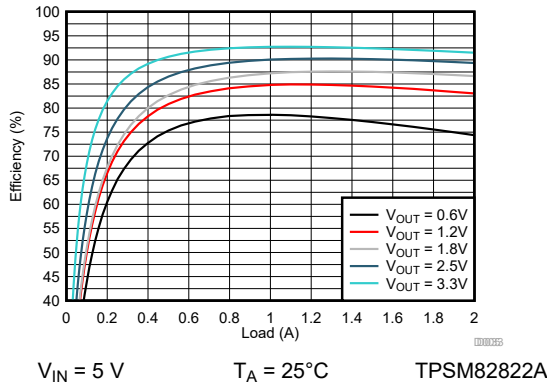

图 9-88. Efficiency

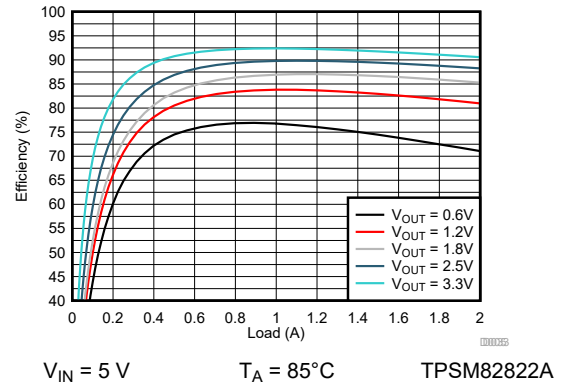

图 9-89. Efficiency

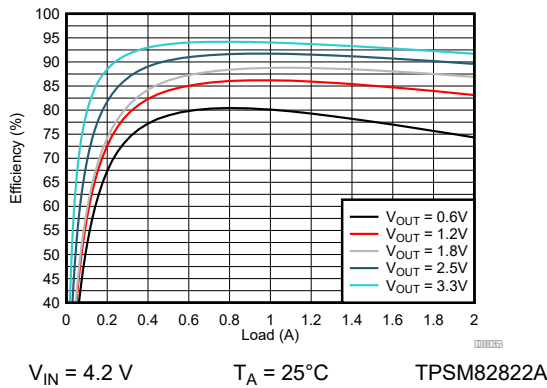

图 9-90. Efficiency

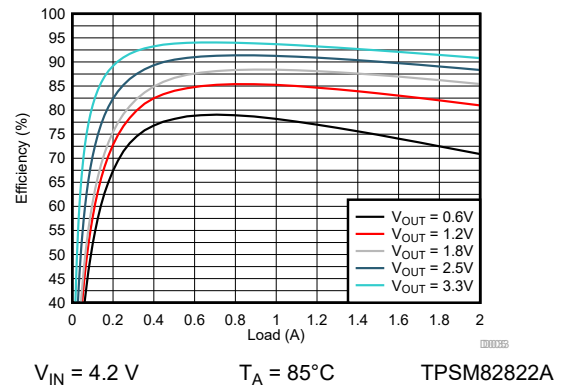

图 9-91. Efficiency

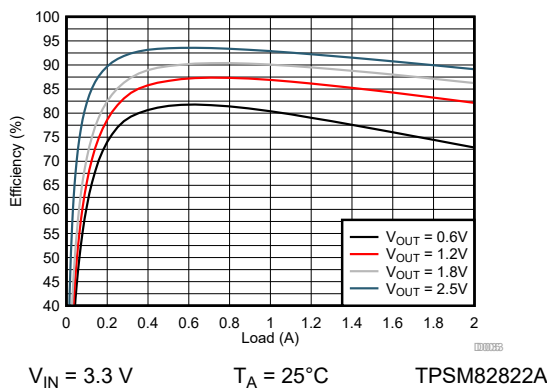

图 9-92. Efficiency

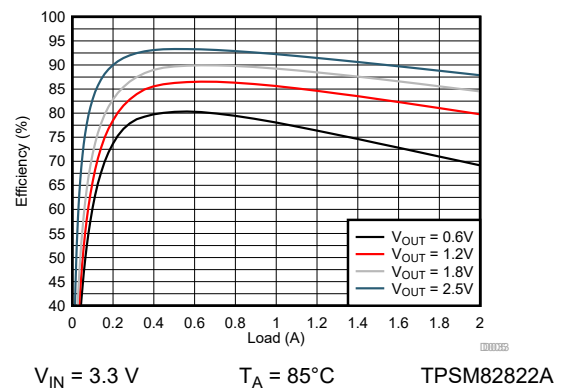

图 9-93. Efficiency

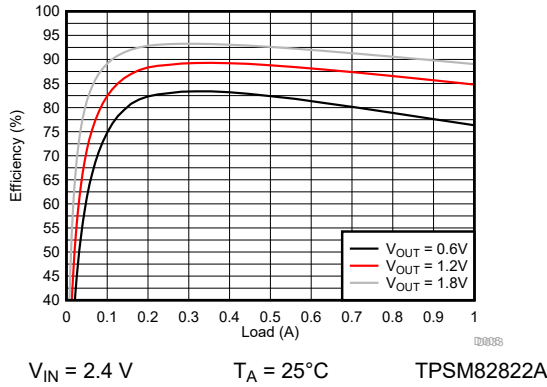

图 9-94. Safe Operating Area

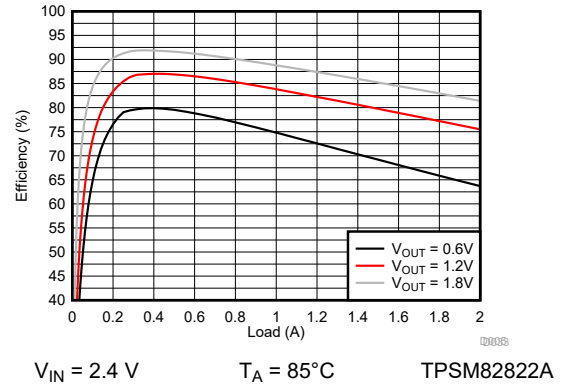

图 9-95. Safe Operating Area

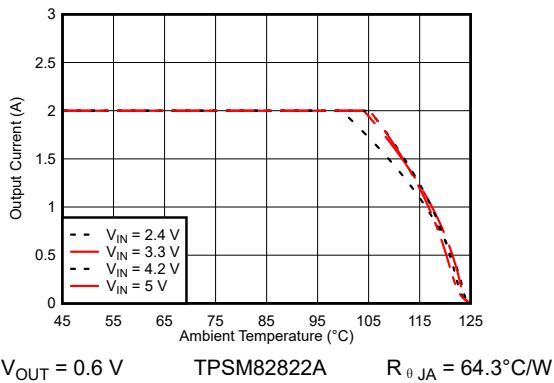

图 9-96. Safe Operating Area

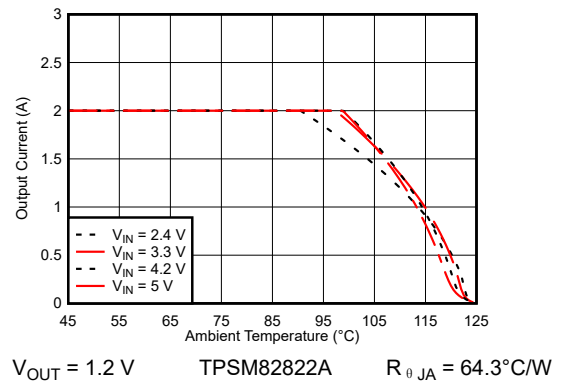

图 9-97. Safe Operating Area

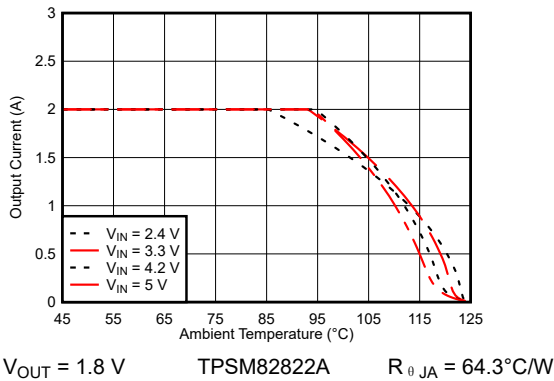

$V_{OUT} = 3.3\text{ V}$  TPSM82822A  $R_{\theta JA} = 64.3^{\circ}\text{C/W}$

图 9-98. Safe Operating Area

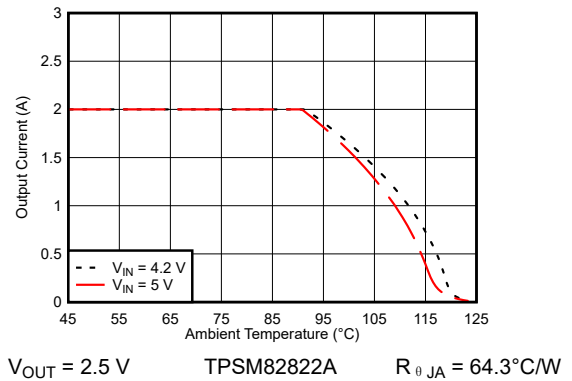
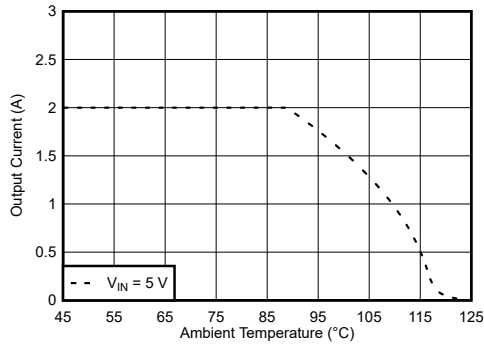
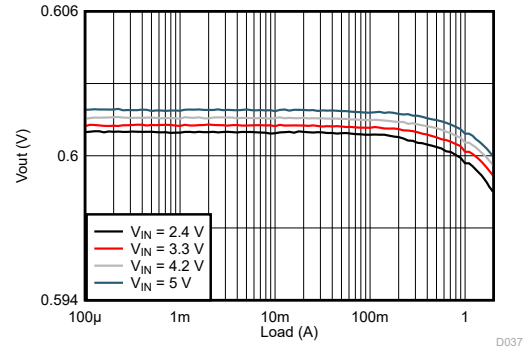

$V_{OUT} = 0.6\text{ V}$  TPSM82822A

图 9-99. Load Regulation

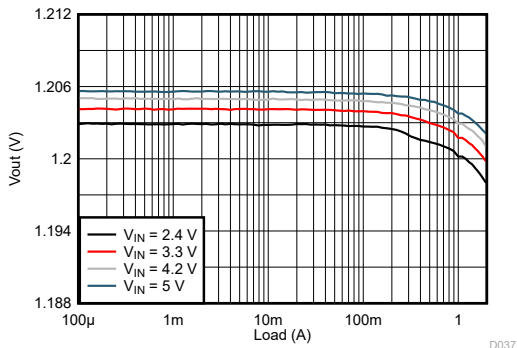

$V_{OUT} = 1.2\text{ V}$  TPSM82822A

图 9-100. Load Regulation

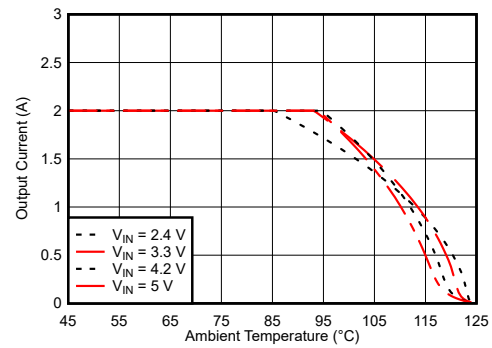

$V_{OUT} = 1.8\text{ V}$  TPSM82822A

图 9-101. Load Regulation

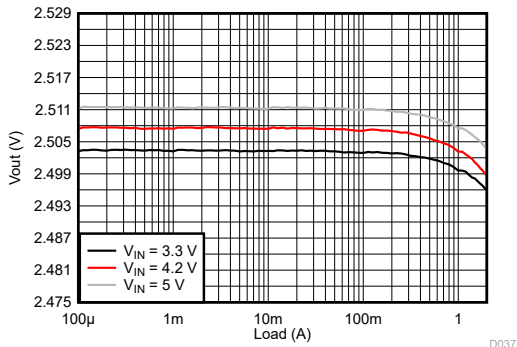

$V_{OUT} = 2.5\text{ V}$  TPSM82822A

图 9-102. Load Regulation

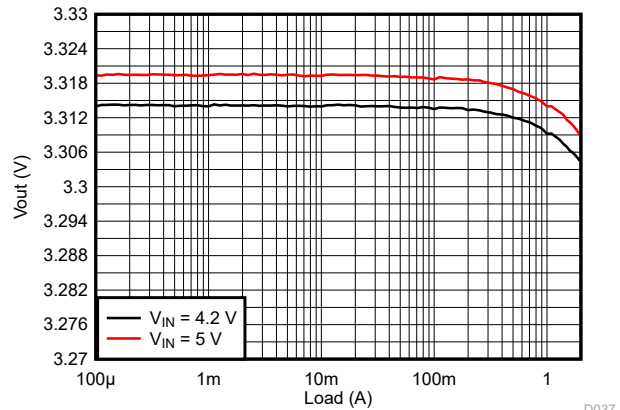

$V_{OUT} = 3.3\text{ V}$  TPSM82822A

图 9-103. Load Regulation

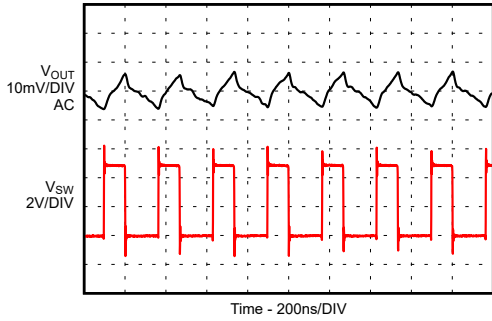

$I_{OUT} = 2\text{ A}$  TPSM82822A

**图 9-104. Output Ripple in PWM Mode**

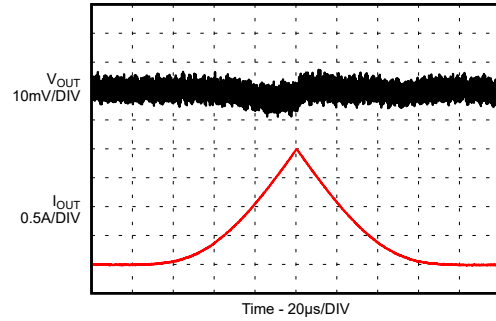

$I_{OUT} = 0\text{ mA to }2\text{ A}$  TPSM82822A

**图 9-105. Load Sweep**

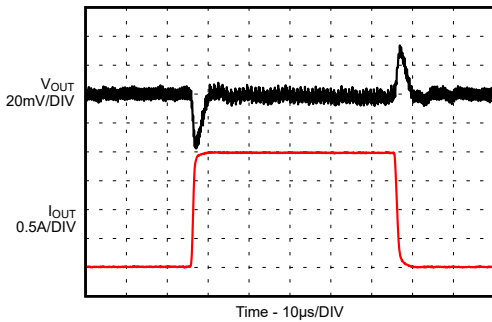

$I_{OUT} = 0\text{ A to }2\text{ A}$  Slew Rate =  $2\text{ A}/\mu\text{s}$  TPSM82822A

**图 9-106. Load Transient**

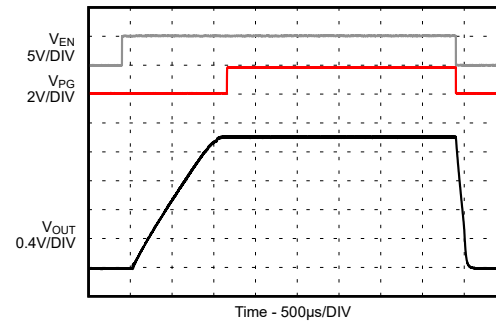

$I_{OUT} = \text{no load}$  TPSM82822A

**图 9-107. Start-up / Shutdown without Load**

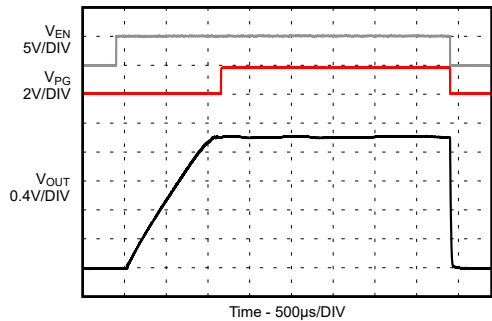

$I_{OUT} = 2\text{ A}$  TPSM82822A

**图 9-108. Start-up / Shutdown with Resistive Load**

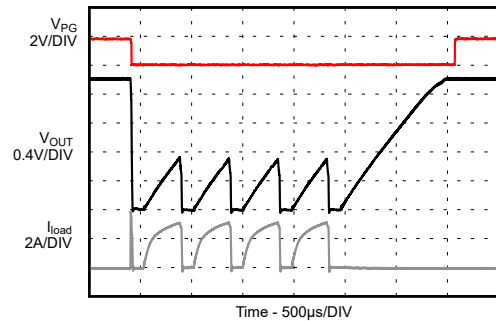

TPSM82822A

**图 9-109. Short Circuit, HICUP Protection Entry / Exit**



**9.2.1.3.5 TPSM82823 Performance Curves**

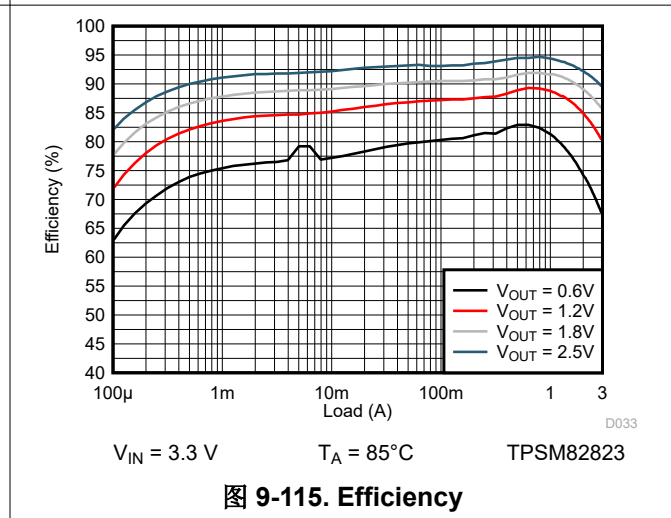
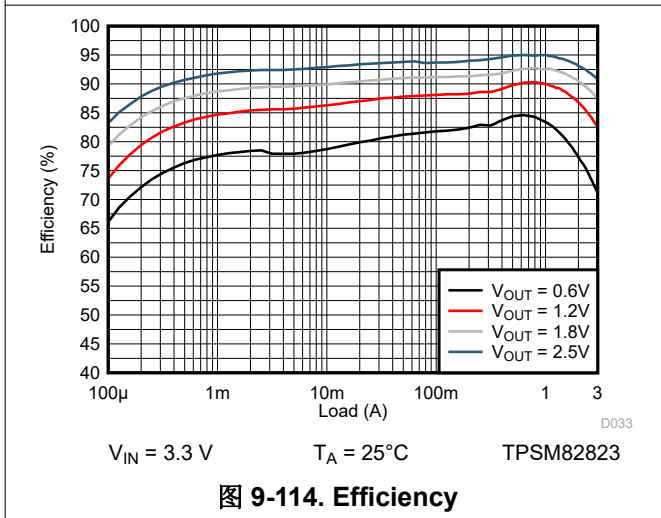
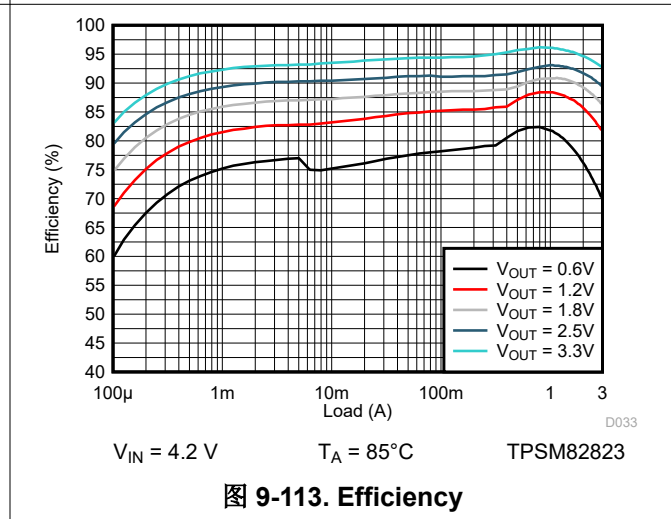
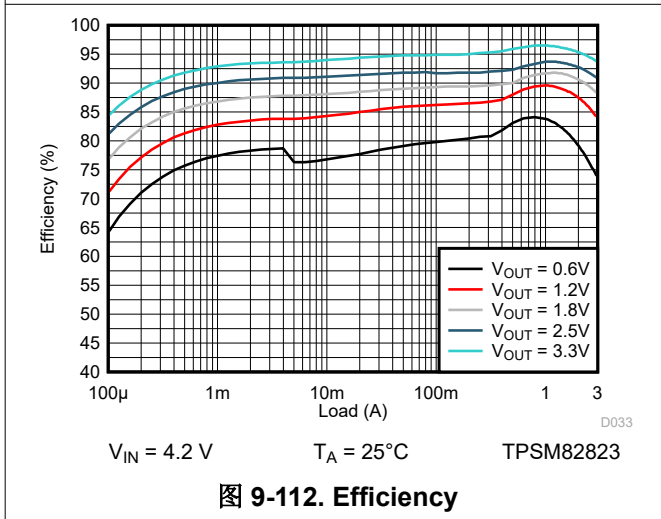
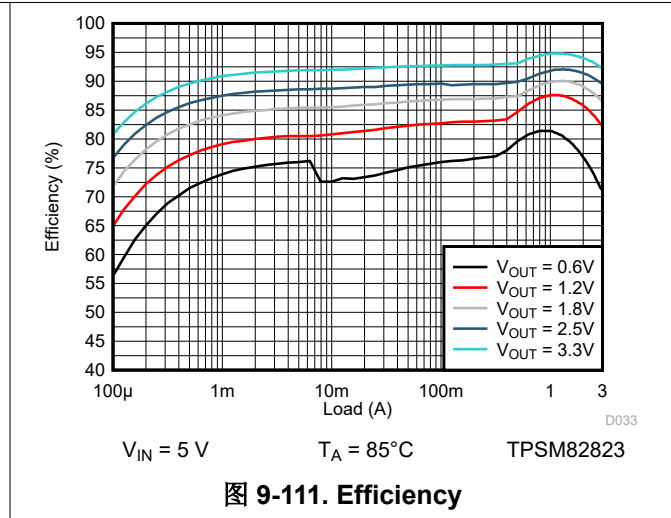
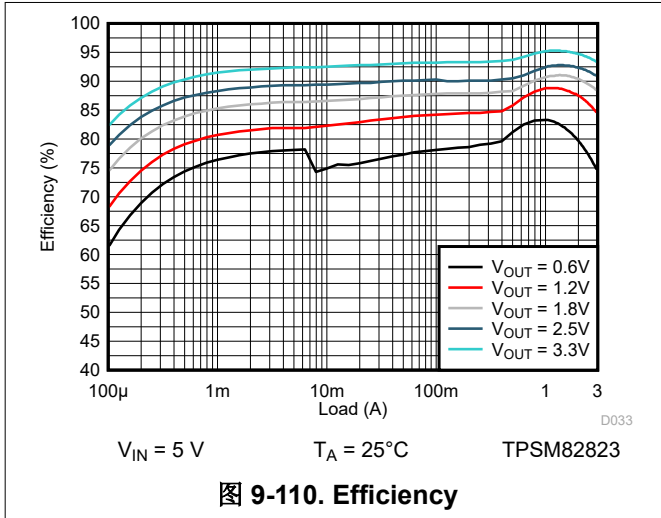



图 9-116. Efficiency



图 9-117. Efficiency

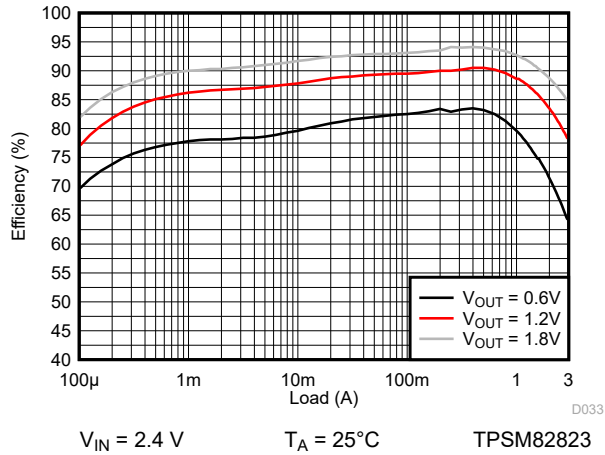

图 9-118. Safe Operating Area

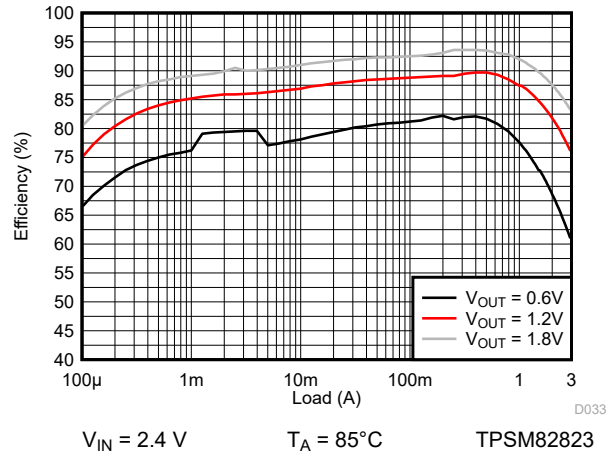

图 9-119. Safe Operating Area

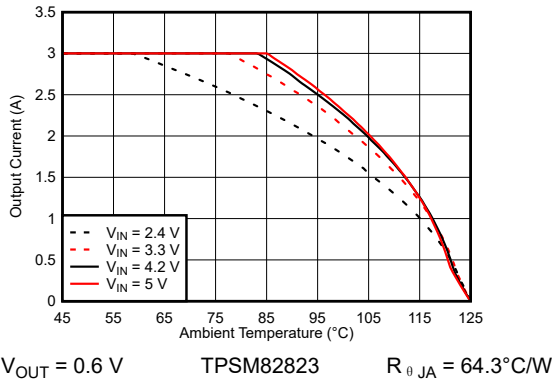

图 9-120. Safe Operating Area

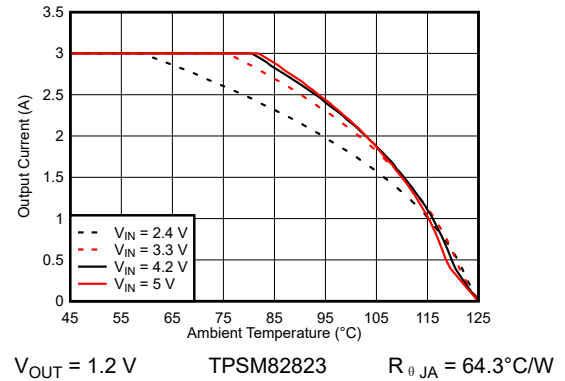

图 9-121. Safe Operating Area

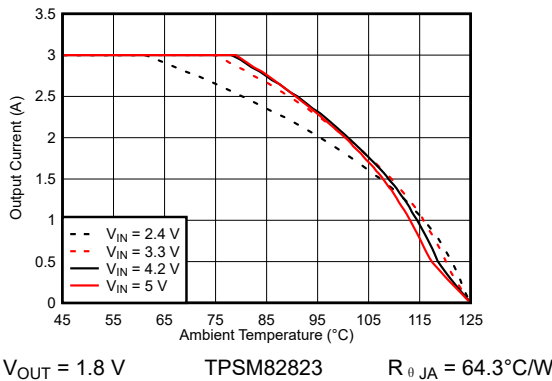

图 9-122. Safe Operating Area

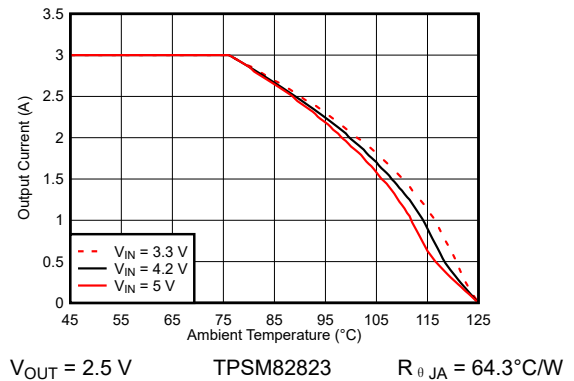

图 9-123. Load Regulation

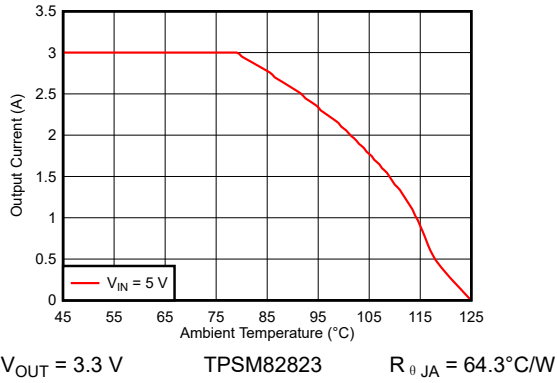

图 9-124. Load Regulation

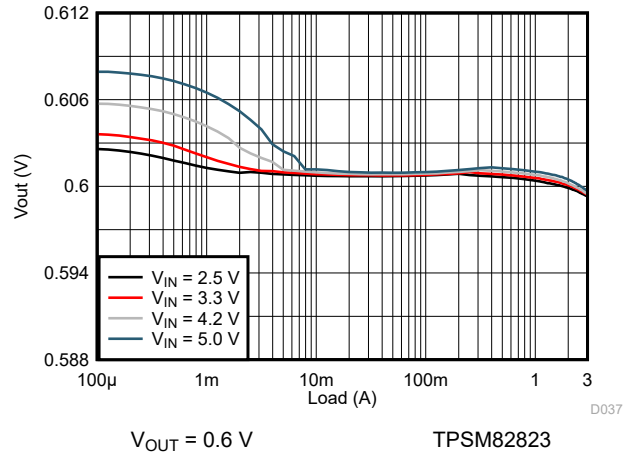

图 9-125. Load Regulation

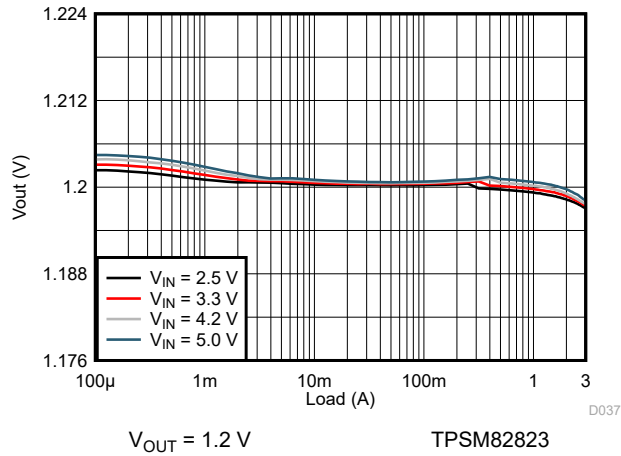

图 9-126. Load Regulation

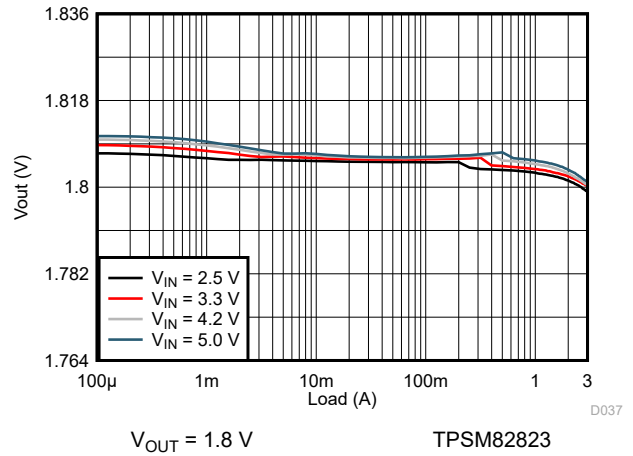

图 9-127. Load Regulation

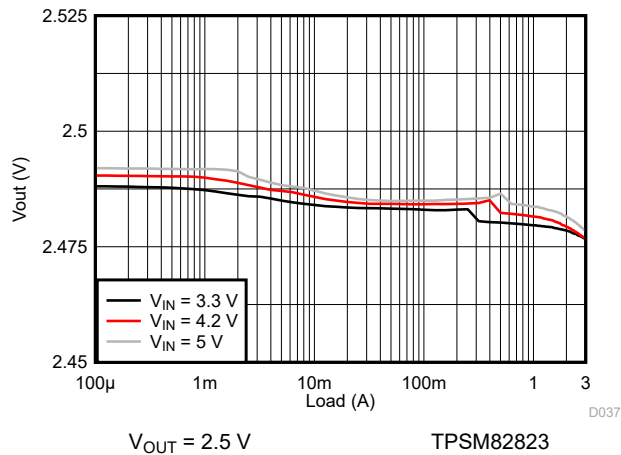

$I_{OUT} = 3\text{ A}$  TPSM82823

图 9-128. Output Ripple in PWM Mode

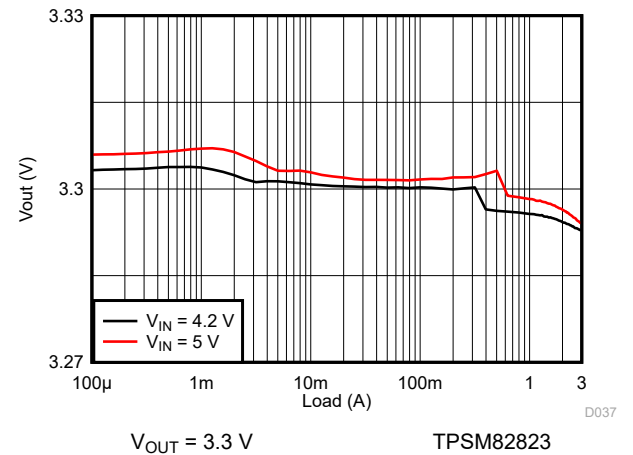
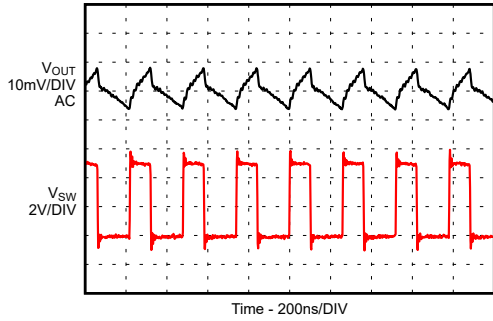
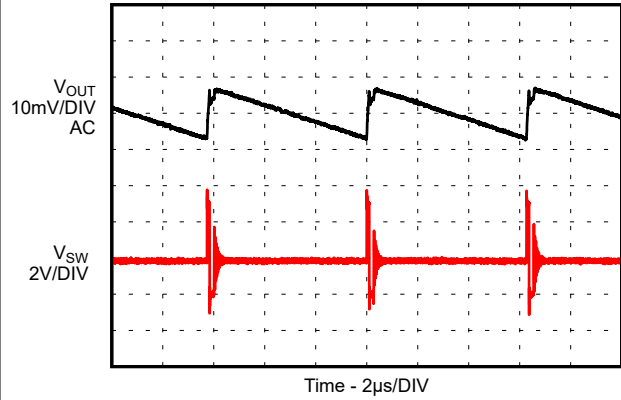

$I_{OUT} = 25\text{ mA}$  TPSM82823

图 9-129. Output Ripple in PSM Mode

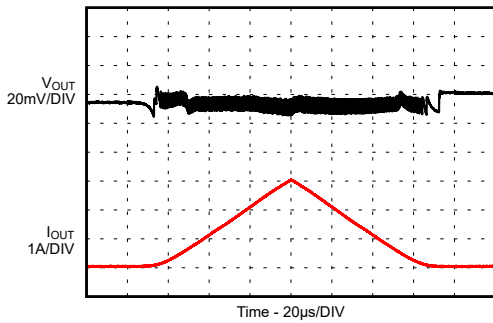

$I_{OUT} = 25\text{ mA to }3\text{ A}$  TPSM82823

图 9-130. Load Sweep

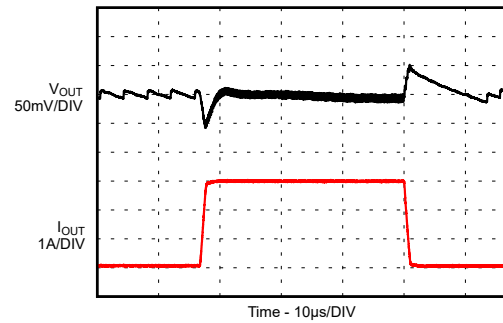

$I_{OUT} = 0\text{ A to }3\text{ A}$  Slew Rate =  $2\text{ A}/\mu\text{s}$  TPSM82823

图 9-131. Load Transient

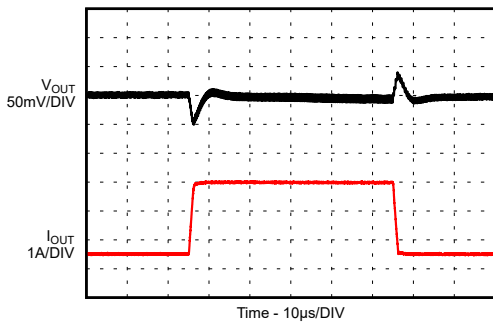

$I_{OUT} = 0.5\text{ A to }3\text{ A}$  Slew Rate =  $2\text{ A}/\mu\text{s}$  TPSM82823

图 9-132. Load Transient

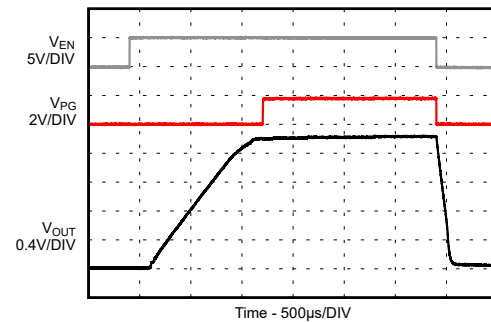

$I_{OUT} = \text{no load}$  TPSM82823

图 9-133. Start-up / Shutdown without Load

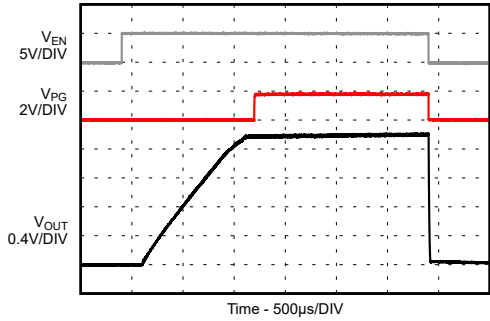

$I_{OUT} = 3\text{ A}$

TPSM82823

图 9-134. Start-up / Shutdown with Resistive Load

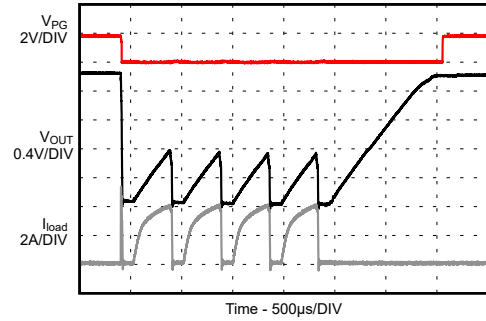

TPSM82823

图 9-135. Short Circuit, HICUP Protection Entry / Exit

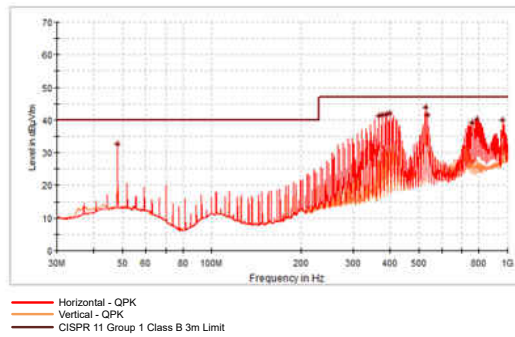

$R_{LOAD} = 0.68\ \Omega$ ,  $V_{IN} = 5.5\text{ V}$  (battery supply),  $V_{OUT} = 1.8\text{ V}$ , tested on TPSM82823EVM-080

图 9-136. TPSM82823 Radiated Emissions

9.2.1.3.6 TPSM82823A Performance Curves



图 9-137. Efficiency



图 9-138. Efficiency

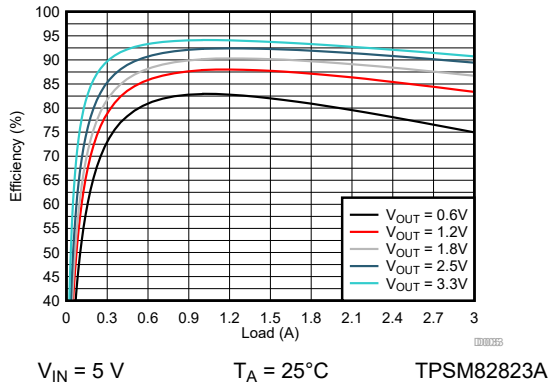

图 9-139. Efficiency

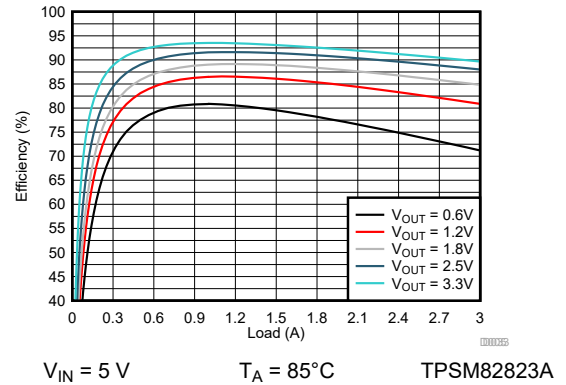

图 9-140. Efficiency

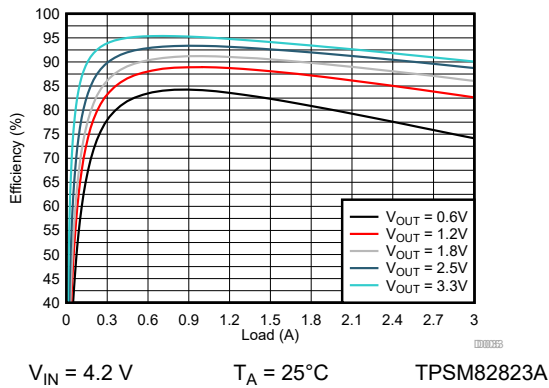

图 9-141. Efficiency

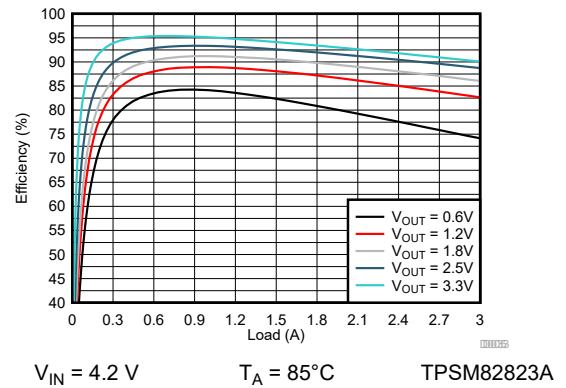

图 9-142. Efficiency

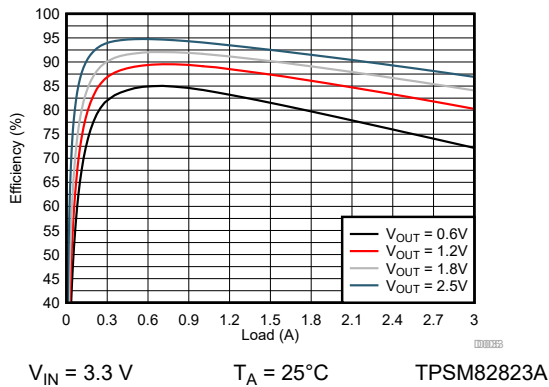

$V_{IN} = 2.4\text{ V}$        $T_A = 25^\circ\text{C}$       TPSM82823A

**图 9-143. Efficiency**

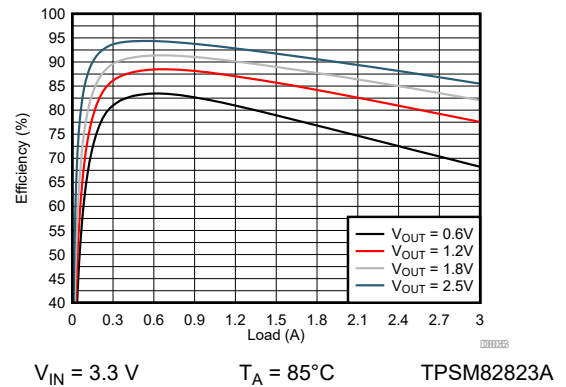
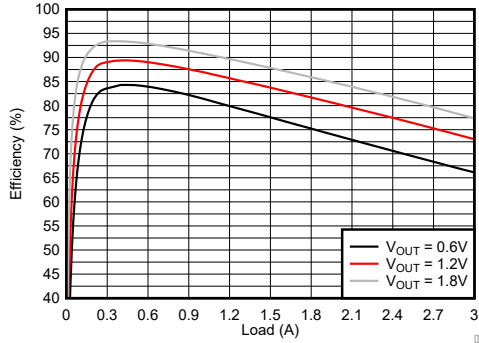
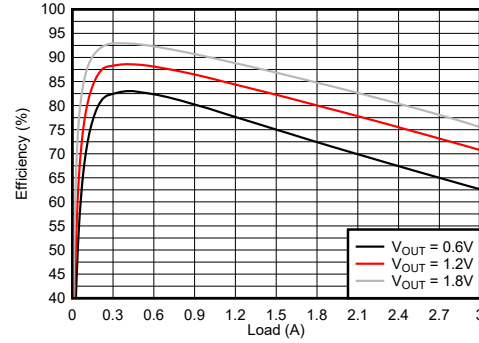

$V_{IN} = 2.4\text{ V}$        $T_A = 85^\circ\text{C}$       TPSM82823A

**图 9-144. Efficiency**

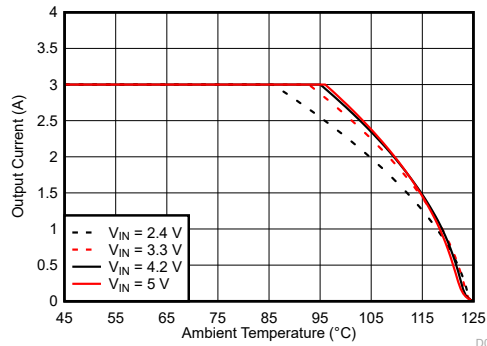

$V_{OUT} = 0.6\text{ V}$       TPSM82823A       $R_{\theta JA} = 64.3^\circ\text{C/W}$

**图 9-145. Safe Operating Area**

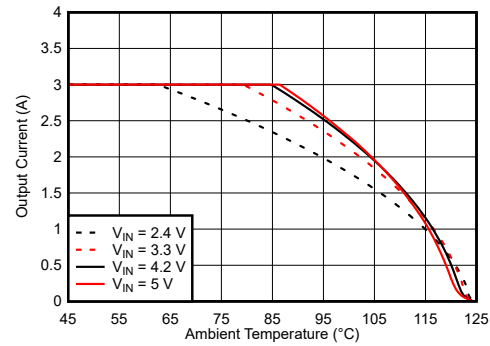

$V_{OUT} = 1.2\text{ V}$       TPSM82823A       $R_{\theta JA} = 64.3^\circ\text{C/W}$

**图 9-146. Safe Operating Area**

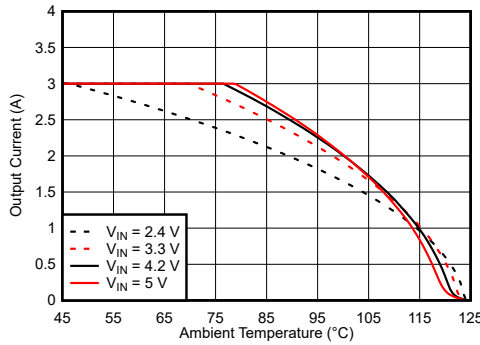

$V_{OUT} = 1.8\text{ V}$       TPSM82823A       $R_{\theta JA} = 64.3^\circ\text{C/W}$

**图 9-147. Safe Operating Area**

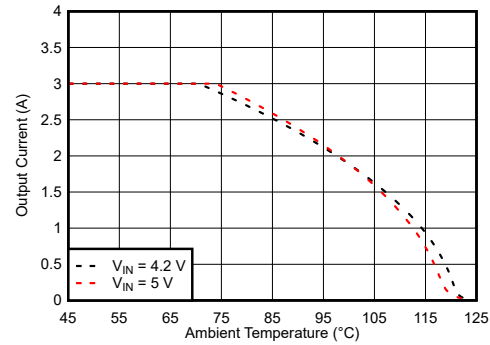

$V_{OUT} = 2.5\text{ V}$       TPSM82823A       $R_{\theta JA} = 64.3^\circ\text{C/W}$

**图 9-148. Safe Operating Area**

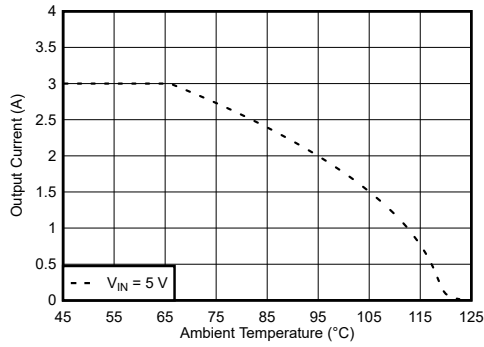

$V_{OUT} = 3.3\text{ V}$       **TPSM82823A**       $R_{\theta JA} = 64.3\text{ }^{\circ}\text{C/W}$

**图 9-149. Safe Operating Area**

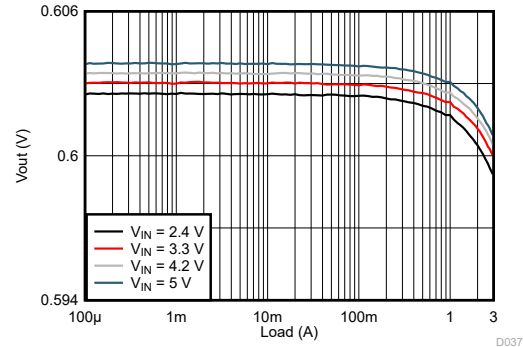

$V_{OUT} = 0.6\text{ V}$       **TPSM82823A**

**图 9-150. Load Regulation**

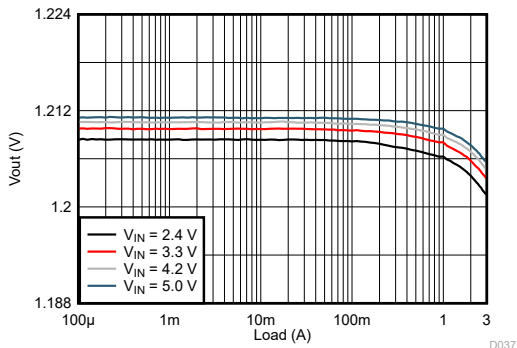

$V_{OUT} = 1.2\text{ V}$       **TPSM82823A**

**图 9-151. Load Regulation**

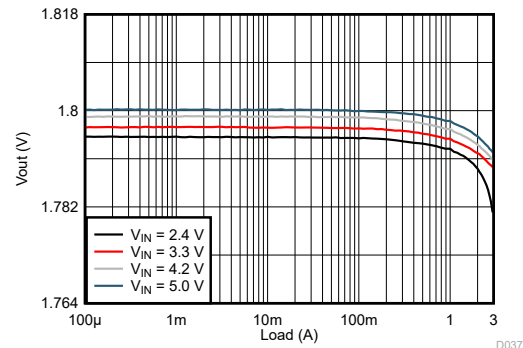

$V_{OUT} = 1.8\text{ V}$       **TPSM82823A**

**图 9-152. Load Regulation**

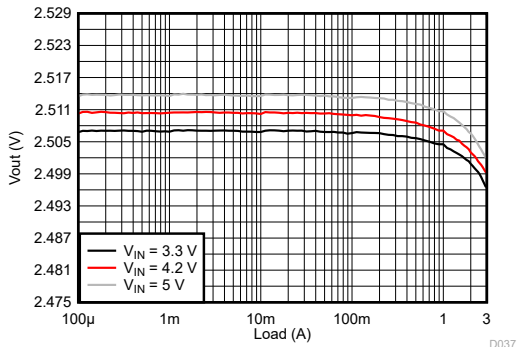

$V_{OUT} = 2.5\text{ V}$       **TPSM82823A**

**图 9-153. Load Regulation**

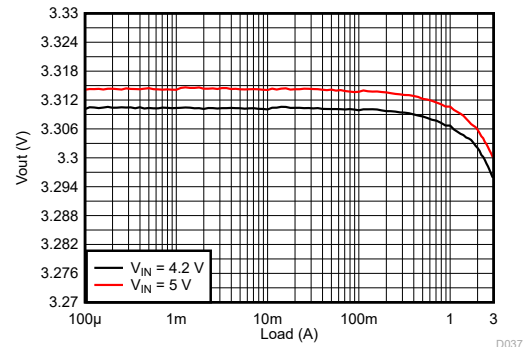

$V_{OUT} = 3.3\text{ V}$       **TPSM82823A**

**图 9-154. Load Regulation**





图 9-155. Output Ripple in PWM Mode



图 9-156. Load Sweep

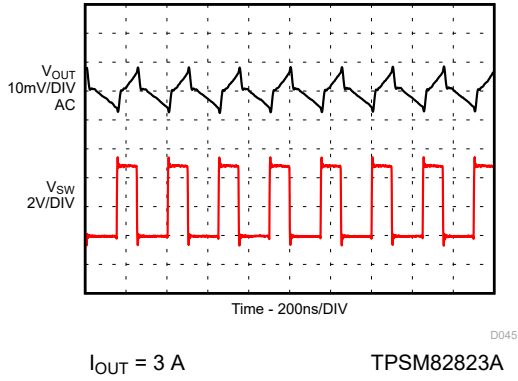

图 9-157. Load Transient

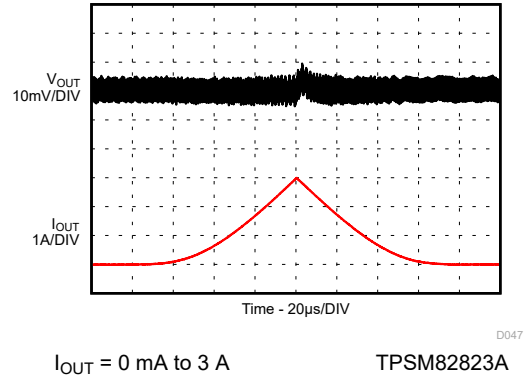

图 9-158. Start-up / Shutdown without Load

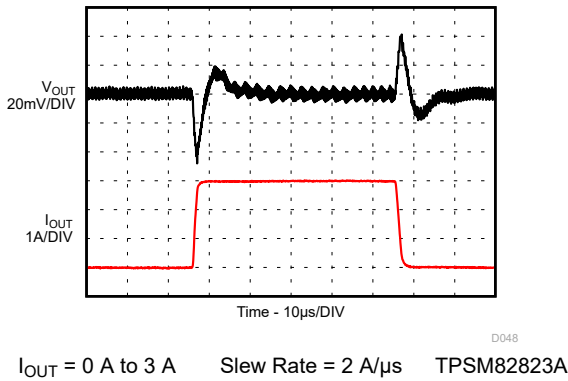

图 9-159. Start-up / Shutdown with Resistive Load

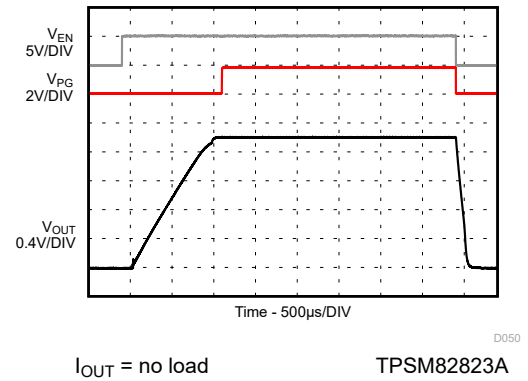

图 9-160. Short Circuit, HICCUP Protection Entry / Exit

## 10 Power Supply Recommendations

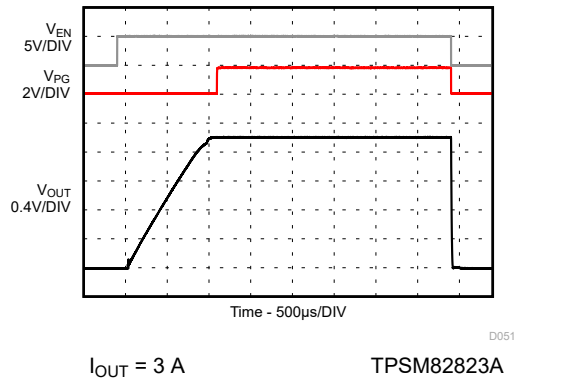
The devices are designed to operate from an input supply voltage range between 2.4 V and 5.5 V. The average input current of the TPSM8282x/TPSM8282xA is calculated as:

$$I_{IN} = \frac{1}{\eta} \times \frac{V_{OUT} \times I_{OUT}}{V_{IN}} \quad (7)$$

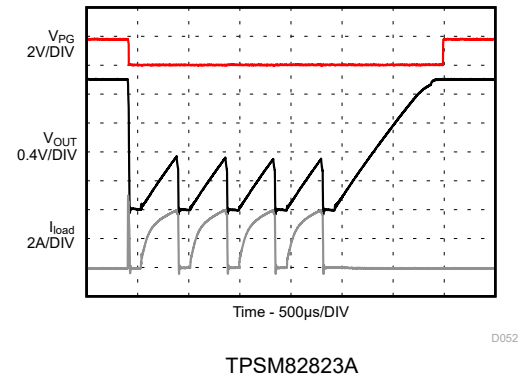
Ensure that the power supply has a sufficient current rating for the application.

## 11 Layout

### 11.1 Layout Guidelines

A proper layout is critical for the operation of any switched mode power supply, especially at high switching frequencies. Therefore, the PCB layout of the TPSM8282x/TPSM8282xA demands careful attention to ensure best performance. A poor layout can lead to issues like bad line and load regulation, instability, increased EMI radiation, and noise sensitivity. Refer to the [Five Steps to a Great PCB Layout for a Step-Down Converter Technical Brief](#) for a detailed discussion of general best practices. Specific recommendations for the device are listed below.

- The input capacitor should be placed as close as possible to the VIN and GND pins of the device. This is the most critical component placement. Route the input capacitor directly to the VIN and GND pins avoiding vias.
- Place the output capacitor ground close to the VOUT and GND pins and route it directly avoiding vias.
- Place the FB resistors, R1 and R2, and the feedforward capacitor  $C_{FF}$  close to the FB pin to minimize noise pickup.
- The recommended layout is implemented on the EVM and shown in its [TPSM8282xEVM-080 Evaluation Module User's Guide](#)
- The recommended land pattern for the TPSM8282x/TPSM8282xA is shown at the end of this data sheet. For best manufacturing results, it is important to create the pads as solder mask defined (SMD), when some pins (such as VIN, VOUT, and GND) are connected to large copper planes. Using SMD pads keeps each pad the same size and avoids solder pulling the device during reflow.

### 11.2 Layout Example



图 11-1. TPSM8282xx PCB Layout for the Fixed Output Voltage Devices (BOM from Table 9-2)



图 11-2. TPSM8282x/TPSM8282xA PCB Layout for the Adjustable Devices (BOM from Table 9-1 with 1 x 22-uF for C2)

### 11.2.1 Thermal Consideration

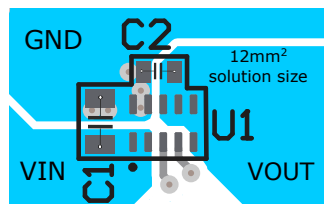
The TPSM8282x/TPSM8282xA module temperature must be kept less than the maximum rating of 125°C. The following are three basic approaches for enhancing thermal performance:

- Improve the power dissipation capability of the PCB design.
- Improve the thermal coupling of the component to the PCB.
- Introduce airflow into the system.

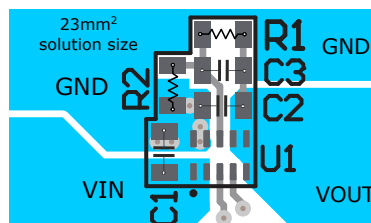
To estimate the approximate module temperature of the TPSM8282x/TPSM8282xA, apply the typical efficiency stated in this data sheet to the desired application condition to compute the power dissipation of the module. Then, calculate the module temperature rise by multiplying the power dissipation by its thermal resistance. Using this method to compute the maximum device temperature, the Safe Operating Area (SOA) graphs demonstrate the required derating in maximum output current at high ambient temperatures. For more details on how to use the thermal parameters in real applications, see the application notes: [Thermal Characteristics of Linear and Logic Packages Using JEDEC PCB Designs](#) and [Semiconductor and IC Package Thermal Metrics](#).

## 12 Device and Documentation Support

### 12.1 Device Support

#### 12.1.1 第三方产品免责声明

TI 发布的与第三方产品或服务有关的信息，不能构成与此类产品或服务或保修的适用性有关的认可，不能构成此类产品或服务单独或与任何 TI 产品或服务一起的表示或认可。

#### 12.1.2 Development Support

##### 12.1.2.1 Models and Simulators

PSpice® for TI is a design and simulation environment that helps evaluate performance of analog circuits. Create subsystem designs and prototype solutions before committing to layout and fabrication, reducing development cost and time to market.

### 12.2 Documentation Support

#### 12.2.1 Related Documentation

For related documentation see the following:

Texas Instruments, [TPSM82822EVM-080 Evaluation Module, SLVUBR5](#)

### 12.3 接收文档更新通知

要接收文档更新通知，请导航至 [ti.com](#) 上的器件产品文件夹。点击 [订阅更新](#) 进行注册，即可每周接收产品信息更改摘要。有关更改的详细信息，请查看任何已修订文档中包含的修订历史记录。

### 12.4 Trademarks

MicroSiP™ are trademarks of TI.

所有商标均为其各自所有者的财产。

### 12.5 Electrostatic Discharge Caution



This integrated circuit can be damaged by ESD. Texas Instruments recommends that all integrated circuits be handled with appropriate precautions. Failure to observe proper handling and installation procedures can cause damage.

ESD damage can range from subtle performance degradation to complete device failure. Precision integrated circuits may be more susceptible to damage because very small parametric changes could cause the device not to meet its published specifications.

### 12.6 术语表

[TI 术语表](#) 本术语表列出并解释了术语、首字母缩略词和定义。

## Mechanical, Packaging, and Orderable Information

The following pages include mechanical, packaging, and orderable information. This information is the most current data available for the designated devices. This data is subject to change without notice and revision of this document. For browser-based versions of this data sheet, refer to the left-hand navigation.

### 13.1 Tape and Reel Information

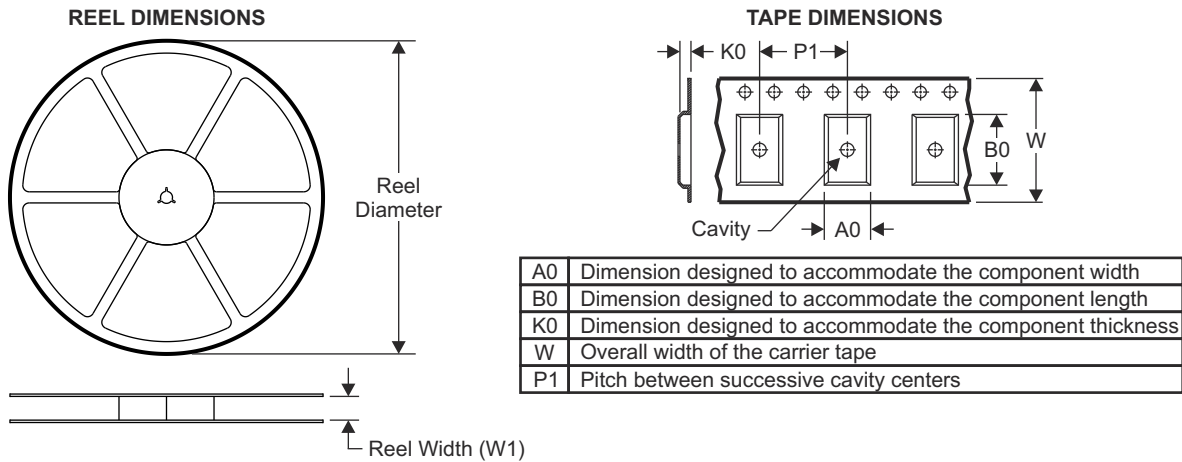

#### QUADRANT ASSIGNMENTS FOR PIN 1 ORIENTATION IN TAPE

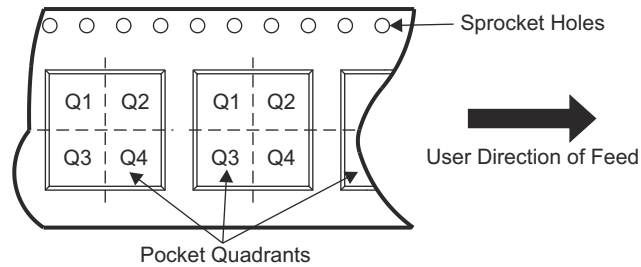

Device	Package Type	Package Drawing	Pins	SPQ	Reel Diameter (mm)	Reel Width W1 (mm)	A0 (mm)	B0 (mm)	K0 (mm)	P1 (mm)	W (mm)	Pin1 Quadrant
TPSM82821SILR	uSiP	SIL	10	3000	330.0	8.4	2.25	2.75	1.25	4.0	8.0	Q1
TPSM82821ASILR	uSiP	SIL	10	3000	330.0	8.4	2.25	2.75	1.25	4.0	8.0	Q1
TPSM828211SILR	uSiP	SIL	10	3000	330.0	8.4	2.25	2.75	1.25	4.0	8.0	Q1
TPSM828212SILR	uSiP	SIL	10	3000	330.0	8.4	2.25	2.75	1.25	4.0	8.0	Q1
TPSM828213SILR	uSiP	SIL	10	3000	330.0	8.4	2.25	2.75	1.25	4.0	8.0	Q1
TPSM828214SILR	uSiP	SIL	10	3000	330.0	8.4	2.25	2.75	1.25	4.0	8.0	Q1
TPSM82822SILR	uSiP	SIL	10	3000	330.0	8.4	2.25	2.75	1.25	4.0	8.0	Q1
TPSM82822ASILR	uSiP	SIL	10	3000	330.0	8.4	2.25	2.75	1.25	4.0	8.0	Q1
TPSM828221SILR	uSiP	SIL	10	3000	330.0	8.4	2.25	2.75	1.25	4.0	8.0	Q1
TPSM828222SILR	uSiP	SIL	10	3000	330.0	8.4	2.25	2.75	1.25	4.0	8.0	Q1
TPSM828223SILR	uSiP	SIL	10	3000	330.0	8.4	2.25	2.75	1.25	4.0	8.0	Q1
TPSM828224SILR	uSiP	SIL	10	3000	330.0	8.4	2.25	2.75	1.25	4.0	8.0	Q1
TPSM82823SILR	uSiP	SIL	10	3000	330.0	8.4	2.25	2.75	1.25	4.0	8.0	Q1
TPSM82823ASILR	uSiP	SIL	10	3000	330.0	8.4	2.25	2.75	1.25	4.0	8.0	Q1

TAPE AND REEL BOX DIMENSIONS

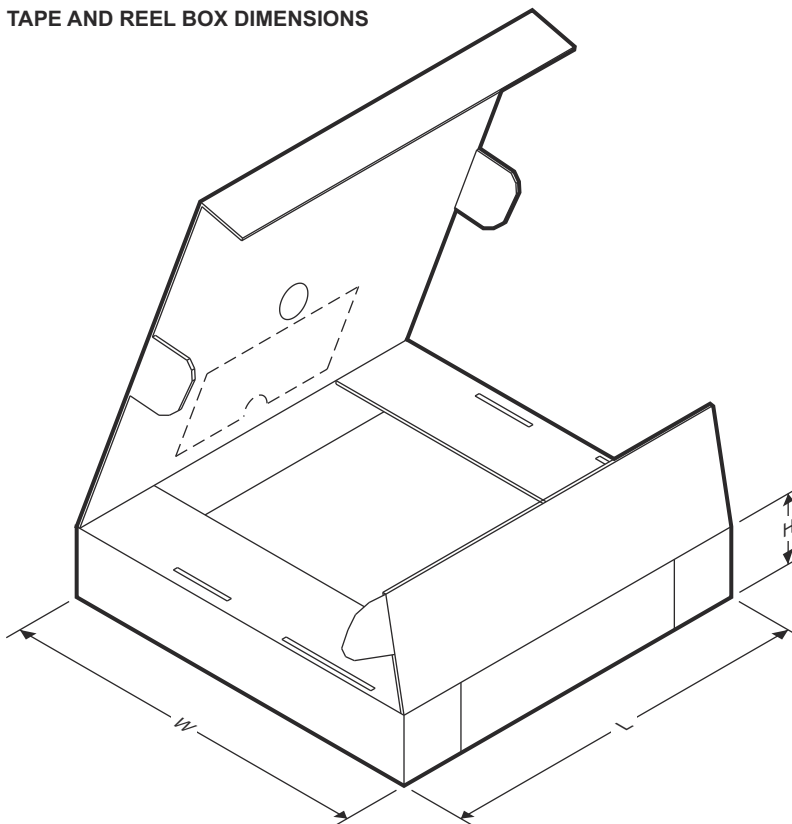

Device	Package Type	Package Drawing	Pins	SPQ	Length (mm)	Width (mm)	Height (mm)
TPSM82821SILR	uSiP	SIL	10	3000	383.0	353.0	58.0
TPSM82821ASILR	uSiP	SIL	10	3000	383.0	353.0	58.0
TPSM828211SILR	uSiP	SIL	10	3000	383.0	353.0	58.0
TPSM828212SILR	uSiP	SIL	10	3000	383.0	353.0	58.0
TPSM828213SILR	uSiP	SIL	10	3000	383.0	353.0	58.0
TPSM828214SILR	uSiP	SIL	10	3000	383.0	353.0	58.0
TPSM82822SILR	uSiP	SIL	10	3000	383.0	353.0	58.0
TPSM82822ASILR	uSiP	SIL	10	3000	383.0	353.0	58.0
TPSM828221SILR	uSiP	SIL	10	3000	383.0	353.0	58.0
TPSM828222SILR	uSiP	SIL	10	3000	383.0	353.0	58.0
TPSM828223SILR	uSiP	SIL	10	3000	383.0	353.0	58.0
TPSM828224SILR	uSiP	SIL	10	3000	383.0	353.0	58.0
TPSM82823SILR	uSiP	SIL	10	3000	383.0	353.0	58.0
TPSM82823ASILR	uSiP	SIL	10	3000	383.0	353.0	58.0

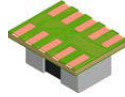

**PACKAGE OUTLINE**

**SIL0010D**

**uSIP™ - 1.1 mm max height**

MICRO SYSTEM IN PACKAGE

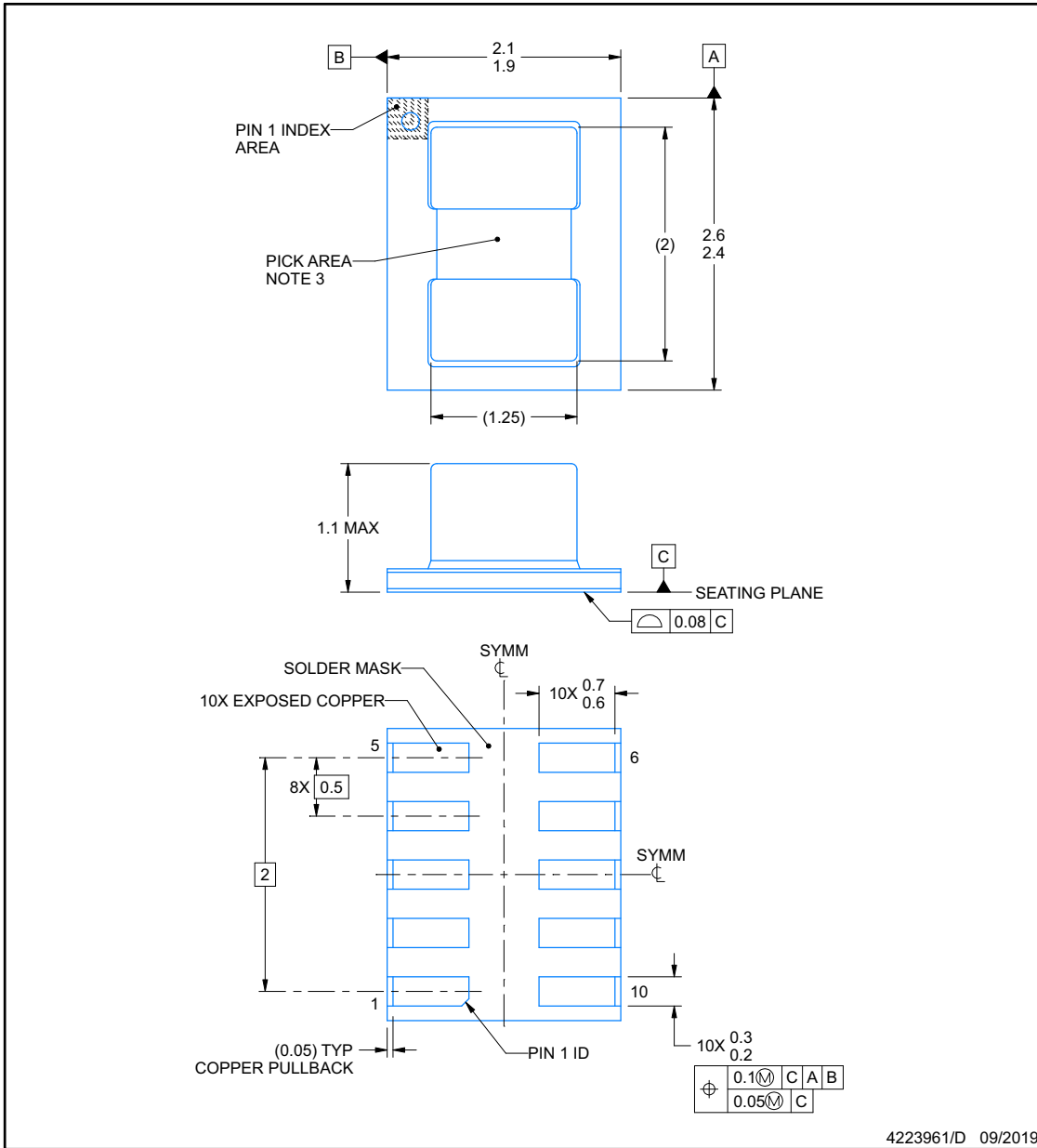

**NOTES:**

MicroSiP is a trademark of Texas Instruments

1. All linear dimensions are in millimeters. Any dimensions in parenthesis are for reference only. Dimensioning and tolerancing per ASME Y14.5M.
2. This drawing is subject to change without notice.
3. Pick and place nozzle  $\varnothing$  0.33 mm or smaller recommended.

## EXAMPLE BOARD LAYOUT

**SIL0010D**

**uSIP™ - 1.1 mm max height**

MICRO SYSTEM IN PACKAGE

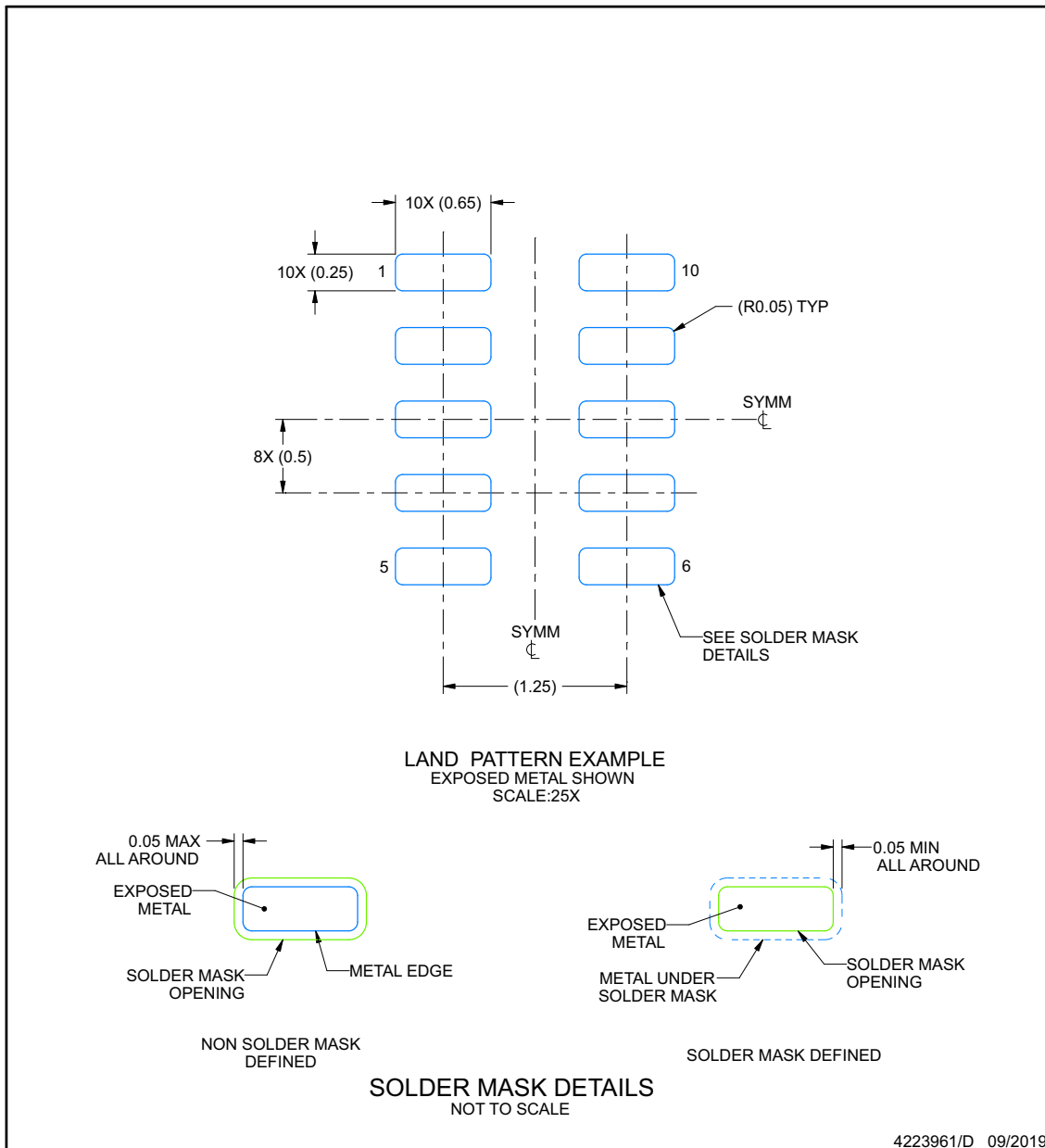

NOTES: (continued)

4. For more information, see Texas Instruments literature number SLUA271 ([www.ti.com/lit/slua271](http://www.ti.com/lit/slua271)).



## EXAMPLE STENCIL DESIGN

**SIL0010D**

**uSIP™ - 1.1 mm max height**

MICRO SYSTEM IN PACKAGE

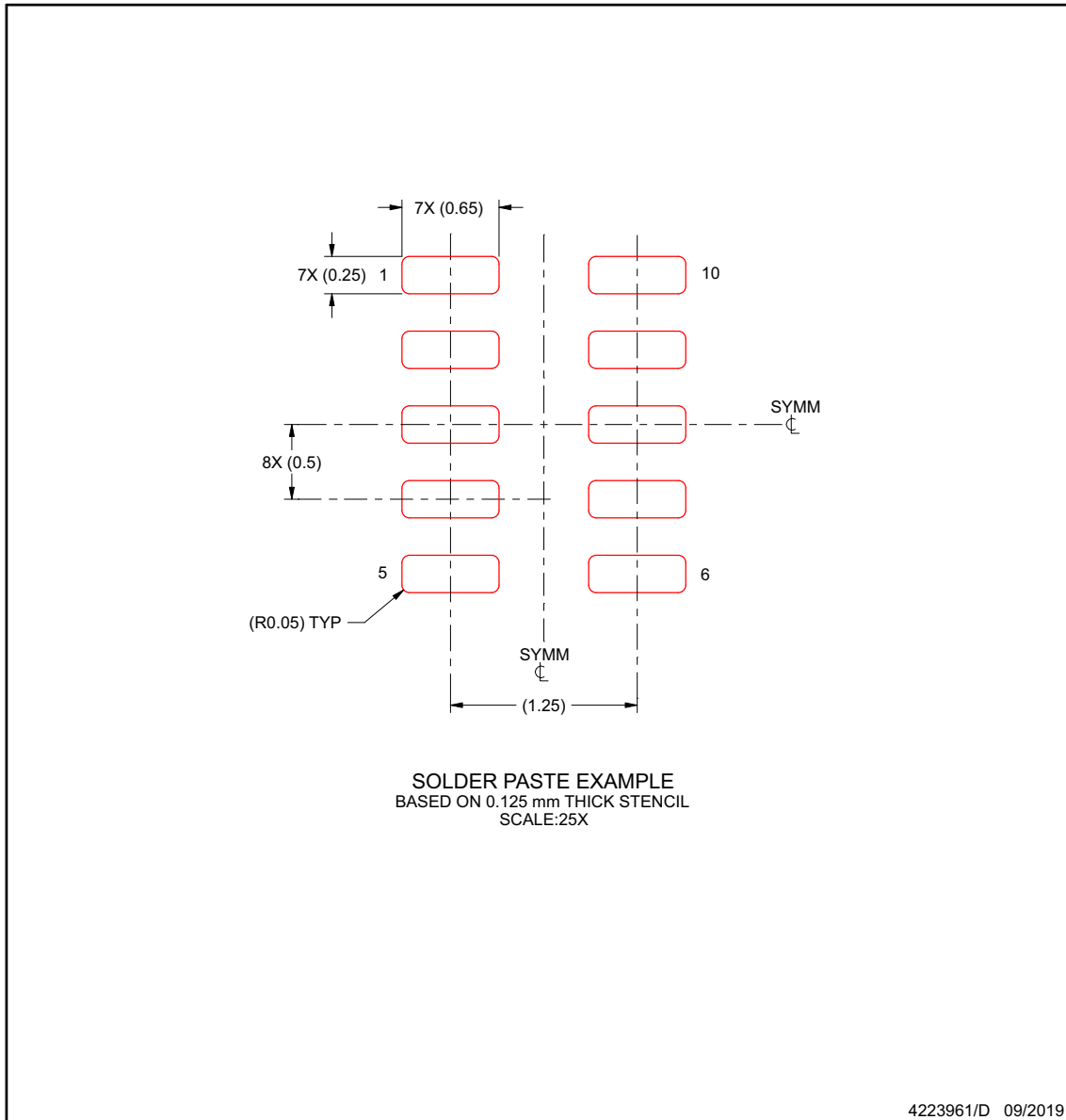

NOTES: (continued)

5. Laser cutting apertures with trapezoidal walls and rounded corners may offer better paste release. IPC-7525 may have alternate design recommendations.

**PACKAGING INFORMATION**

Orderable Device	Status (1)	Package Type	Package Drawing	Pins	Package Qty	Eco Plan (2)	Lead finish/ Ball material (6)	MSL Peak Temp (3)	Op Temp (°C)	Device Marking (4/5)	Samples
TPSM828211SILR	ACTIVE	uSiP	SIL	10	3000	RoHS & Green	ENEPIG	Level-2-260C-1 YEAR	-40 to 125	GA1	<a href="#">Samples</a>
TPSM828212SILR	ACTIVE	uSiP	SIL	10	3000	RoHS & Green	ENEPIG	Level-2-260C-1 YEAR	-40 to 125	GA2	<a href="#">Samples</a>
TPSM828213SILR	ACTIVE	uSiP	SIL	10	3000	RoHS & Green	ENEPIG	Level-2-260C-1 YEAR	-40 to 125	GA3	<a href="#">Samples</a>
TPSM828214SILR	ACTIVE	uSiP	SIL	10	3000	RoHS & Green	ENEPIG	Level-2-260C-1 YEAR	-40 to 125	GA4	<a href="#">Samples</a>
TPSM82821ASILR	ACTIVE	uSiP	SIL	10	3000	RoHS & Green	NIPDAU	Level-2-260C-1 YEAR	-40 to 125	L5	<a href="#">Samples</a>
TPSM82821SILR	ACTIVE	uSiP	SIL	10	3000	RoHS & Green	ENEPIG	Level-2-260C-1 YEAR	-40 to 125	GA	<a href="#">Samples</a>
TPSM828221SILR	ACTIVE	uSiP	SIL	10	3000	RoHS & Green	ENEPIG	Level-2-260C-1 YEAR	-40 to 125	G91	<a href="#">Samples</a>
TPSM828222SILR	ACTIVE	uSiP	SIL	10	3000	RoHS & Green	ENEPIG	Level-2-260C-1 YEAR	-40 to 125	G92	<a href="#">Samples</a>
TPSM828223SILR	ACTIVE	uSiP	SIL	10	3000	RoHS & Green	ENEPIG	Level-2-260C-1 YEAR	-40 to 125	G93	<a href="#">Samples</a>
TPSM828224SILR	ACTIVE	uSiP	SIL	10	3000	RoHS & Green	ENEPIG	Level-2-260C-1 YEAR	-40 to 125	G94	<a href="#">Samples</a>
TPSM82822ASILR	ACTIVE	uSiP	SIL	10	3000	RoHS & Green	NIPDAU	Level-2-260C-1 YEAR	-40 to 125	L6	<a href="#">Samples</a>
TPSM82822SILR	ACTIVE	uSiP	SIL	10	3000	RoHS & Green	ENEPIG	Level-2-260C-1 YEAR	-40 to 125	G9	<a href="#">Samples</a>
TPSM82823ASILR	ACTIVE	uSiP	SIL	10	3000	RoHS & Green	NIPDAU	Level-2-260C-1 YEAR	-40 to 125	L7	<a href="#">Samples</a>
TPSM82823SILR	ACTIVE	uSiP	SIL	10	3000	RoHS & Green	ENEPIG	Level-2-260C-1 YEAR	-40 to 125	KM	<a href="#">Samples</a>

(1) The marketing status values are defined as follows:

**ACTIVE:** Product device recommended for new designs.

**LIFEBUY:** TI has announced that the device will be discontinued, and a lifetime-buy period is in effect.

**NRND:** Not recommended for new designs. Device is in production to support existing customers, but TI does not recommend using this part in a new design.

**PREVIEW:** Device has been announced but is not in production. Samples may or may not be available.

**OBSELETE:** TI has discontinued the production of the device.

(2) **RoHS:** TI defines "RoHS" to mean semiconductor products that are compliant with the current EU RoHS requirements for all 10 RoHS substances, including the requirement that RoHS substance do not exceed 0.1% by weight in homogeneous materials. Where designed to be soldered at high temperatures, "RoHS" products are suitable for use in specified lead-free processes. TI may reference these types of products as "Pb-Free".

**RoHS Exempt:** TI defines "RoHS Exempt" to mean products that contain lead but are compliant with EU RoHS pursuant to a specific EU RoHS exemption.

**Green:** TI defines "Green" to mean the content of Chlorine (Cl) and Bromine (Br) based flame retardants meet JS709B low halogen requirements of  $\leq 1000$ ppm threshold. Antimony trioxide based flame retardants must also meet the  $\leq 1000$ ppm threshold requirement.

(3) MSL, Peak Temp. - The Moisture Sensitivity Level rating according to the JEDEC industry standard classifications, and peak solder temperature.

(4) There may be additional marking, which relates to the logo, the lot trace code information, or the environmental category on the device.

(5) Multiple Device Markings will be inside parentheses. Only one Device Marking contained in parentheses and separated by a "~" will appear on a device. If a line is indented then it is a continuation of the previous line and the two combined represent the entire Device Marking for that device.

(6) Lead finish/Ball material - Orderable Devices may have multiple material finish options. Finish options are separated by a vertical ruled line. Lead finish/Ball material values may wrap to two lines if the finish value exceeds the maximum column width.

**Important Information and Disclaimer:** The information provided on this page represents TI's knowledge and belief as of the date that it is provided. TI bases its knowledge and belief on information provided by third parties, and makes no representation or warranty as to the accuracy of such information. Efforts are underway to better integrate information from third parties. TI has taken and continues to take reasonable steps to provide representative and accurate information but may not have conducted destructive testing or chemical analysis on incoming materials and chemicals. TI and TI suppliers consider certain information to be proprietary, and thus CAS numbers and other limited information may not be available for release.

In no event shall TI's liability arising out of such information exceed the total purchase price of the TI part(s) at issue in this document sold by TI to Customer on an annual basis.

**TAPE AND REEL INFORMATION**

**QUADRANT ASSIGNMENTS FOR PIN 1 ORIENTATION IN TAPE**

\*All dimensions are nominal

Device	Package Type	Package Drawing	Pins	SPQ	Reel Diameter (mm)	Reel Width W1 (mm)	A0 (mm)	B0 (mm)	K0 (mm)	P1 (mm)	W (mm)	Pin1 Quadrant
TPSM828211SILR	uSiP	SIL	10	3000	330.0	8.4	2.25	2.75	1.25	4.0	8.0	Q1
TPSM828212SILR	uSiP	SIL	10	3000	330.0	8.4	2.25	2.75	1.25	4.0	8.0	Q1
TPSM828213SILR	uSiP	SIL	10	3000	330.0	8.4	2.25	2.75	1.25	4.0	8.0	Q1
TPSM828214SILR	uSiP	SIL	10	3000	330.0	8.4	2.25	2.75	1.25	4.0	8.0	Q1
TPSM82821ASILR	uSiP	SIL	10	3000	330.0	8.4	2.25	2.75	1.25	4.0	8.0	Q1
TPSM82821SILR	uSiP	SIL	10	3000	330.0	8.4	2.25	2.75	1.25	4.0	8.0	Q1
TPSM828221SILR	uSiP	SIL	10	3000	330.0	8.4	2.25	2.75	1.25	4.0	8.0	Q1
TPSM828222SILR	uSiP	SIL	10	3000	330.0	8.4	2.25	2.75	1.25	4.0	8.0	Q1
TPSM828223SILR	uSiP	SIL	10	3000	330.0	8.4	2.25	2.75	1.25	4.0	8.0	Q1
TPSM828224SILR	uSiP	SIL	10	3000	330.0	8.4	2.25	2.75	1.25	4.0	8.0	Q1
TPSM82822ASILR	uSiP	SIL	10	3000	330.0	8.4	2.25	2.75	1.25	4.0	8.0	Q1
TPSM82822SILR	uSiP	SIL	10	3000	330.0	8.4	2.25	2.75	1.25	4.0	8.0	Q1
TPSM82823ASILR	uSiP	SIL	10	3000	330.0	8.4	2.25	2.75	1.25	4.0	8.0	Q1
TPSM82823SILR	uSiP	SIL	10	3000	330.0	8.4	2.25	2.75	1.25	4.0	8.0	Q1

**TAPE AND REEL BOX DIMENSIONS**

\*All dimensions are nominal

Device	Package Type	Package Drawing	Pins	SPQ	Length (mm)	Width (mm)	Height (mm)
TPSM828211SILR	uSiP	SIL	10	3000	383.0	353.0	58.0
TPSM828212SILR	uSiP	SIL	10	3000	383.0	353.0	58.0
TPSM828213SILR	uSiP	SIL	10	3000	383.0	353.0	58.0
TPSM828214SILR	uSiP	SIL	10	3000	383.0	353.0	58.0
TPSM82821ASILR	uSiP	SIL	10	3000	383.0	353.0	58.0
TPSM82821SILR	uSiP	SIL	10	3000	383.0	353.0	58.0
TPSM828221SILR	uSiP	SIL	10	3000	383.0	353.0	58.0
TPSM828222SILR	uSiP	SIL	10	3000	383.0	353.0	58.0
TPSM828223SILR	uSiP	SIL	10	3000	383.0	353.0	58.0
TPSM828224SILR	uSiP	SIL	10	3000	383.0	353.0	58.0
TPSM82822ASILR	uSiP	SIL	10	3000	383.0	353.0	58.0
TPSM82822SILR	uSiP	SIL	10	3000	383.0	353.0	58.0
TPSM82823ASILR	uSiP	SIL	10	3000	383.0	353.0	58.0
TPSM82823SILR	uSiP	SIL	10	3000	383.0	353.0	58.0

## 重要声明和免责声明

TI“按原样”提供技术和可靠性数据（包括数据表）、设计资源（包括参考设计）、应用或其他设计建议、网络工具、安全信息和其他资源，不保证没有瑕疵且不做任何明示或暗示的担保，包括但不限于对适销性、某特定用途方面的适用性或不侵犯任何第三方知识产权的暗示担保。

这些资源可供使用 TI 产品进行设计的熟练开发人员使用。您将自行承担以下全部责任：(1) 针对您的应用选择合适的 TI 产品，(2) 设计、验证并测试您的应用，(3) 确保您的应用满足相应标准以及任何其他功能安全、信息安全、监管或其他要求。

这些资源如有变更，恕不另行通知。TI 授权您仅可将这些资源用于研发本资源所述的 TI 产品的应用。严禁对这些资源进行其他复制或展示。您无权使用任何其他 TI 知识产权或任何第三方知识产权。您应全额赔偿因在这些资源的使用中对 TI 及其代表造成的任何索赔、损害、成本、损失和债务，TI 对此概不负责。

TI 提供的产品受 [TI 的销售条款](#) 或 [ti.com](#) 上其他适用条款/TI 产品随附的其他适用条款的约束。TI 提供这些资源并不会扩展或以其他方式更改 TI 针对 TI 产品发布的适用的担保或担保免责声明。

TI 反对并拒绝您可能提出的任何其他或不同的条款。

邮寄地址：Texas Instruments, Post Office Box 655303, Dallas, Texas 75265

Copyright © 2022，德州仪器 (TI) 公司

## X-ON Electronics

Largest Supplier of Electrical and Electronic Components

*Click to view similar products for [Switching Voltage Regulators](#) category:*

*Click to view products by [Texas Instruments](#) manufacturer:*

Other Similar products are found below :

[FAN53610AUC33X](#) [FAN53611AUC123X](#) [EN6310QA](#) [160215](#) [R3](#) [KE177614](#) [FAN53611AUC12X](#) [MAX809TTR](#) [NCV891234MW50R2G](#)  
[AST1S31PUR](#) [NCP81203PMNTXG](#) [NCP81208MNTXG](#) [PCA9412AUKZ](#) [NCP81109GMNTXG](#) [NCP3235MNTXG](#) [NCP81109JMNTXG](#)  
[NCP81241MNTXG](#) [NTE7223](#) [NTE7222](#) [NTE7224](#) [L6986FTR](#) [MPQ4481GU-AEC1-P](#) [MP8756GD-P](#) [MPQ2171GJ-P](#) [MPQ2171GJ-AEC1-P](#)  
[N JW4153U2-A-TE2](#) [MP2171GJ-P](#) [MP28160GC-Z](#) [XDPE132G5CG000XUMA1](#) [LM60440AQRPKRQ1](#) [MP5461GC-P](#) [IW673-20](#)  
[NCV896530MWATXG](#) [MPQ4409GQBE-AEC1-P](#) [S-19903DA-A8T1U7](#) [S-19903CA-A6T8U7](#) [S-19903CA-S8T1U7](#) [S-19902BA-A6T8U7](#)  
[S-19902CA-A6T8U7](#) [S-19902AA-A6T8U7](#) [S-19903AA-A6T8U7](#) [S-19902AA-S8T1U7](#) [S-19902BA-A8T1U7](#) [AU8310](#)  
[LMR23615QDRRRQ1](#) [LMR33630APAQRN XRQ1](#) [LMR33630APCQRN XRQ1](#) [LMR36503R5RPER](#) [LMR36503RFRPER](#)  
[LMR36503RS3QRPERQ1](#)