

TPSM83100 and TPSM83101 1.5-A Output Current, Buck-Boost MicroSiP™ Power Module with Integrated Inductor

1 Features

- 1.6-V to 5.5-V input voltage range
 - Device input voltage > 1.65 V for start-up
- 1.2-V to 5.5-V output voltage range
 - 1.0-V V_{OUT} is supported in PFM mode
- High output current capability, 3-A peak switch current
 - 1.5-A I_{OUT} for $V_{IN} \geq 3$ V, $V_{OUT} = 3.3$ V
 - 1.2-A I_{OUT} for $V_{IN} \geq 2.7$ V, $V_{OUT} = 3.3$ V
- Active output discharge (TPSM83101 only)
- High efficiency over the entire load range
 - 8- μ A typical quiescent current
 - Automatic power save mode and forced PWM mode
- Peak current buck-boost mode architecture
 - Seamless mode transition
 - Forward and reverse current operation
 - Start-up into pre-biased outputs
 - Fixed-frequency operation with 2-MHz switching
- Safety and robust operation features
 - Overcurrent protection and short-circuit protection
 - Integrated soft start with active ramp adoption
 - Overtemperature protection and overvoltage protection
 - True shutdown function with load disconnection
 - Forward and backward current limit
- Small solution size
 - MicroSiP™ power module with integrated inductor
 - 2.0-mm × 2.6-mm × 1.2-mm(max) 8-pin μ SiP package

2 Applications

- Voltage stabilizer (datacom, [optical modules](#), cooling/heating)
- System pre-regulator ([smartphone](#), [tablet](#), terminal, [telematics](#))
- Point-of-load regulation (wired sensor, [port/cable adapter](#), and [dongle](#))
- Fingerprint, camera sensors ([electronic smart lock](#), [IP network camera](#))

3 Description

The TPSM83100 and TPSM83101 are constant frequency peak current mode control buck-boost MicroSiP™ power modules optimized for small solution size and high efficiency. The power modules integrate an inductor to simplify design, reduce external components and save PCB area. They have a 3-A peak current limit (typical) and 1.6-V to 5.5-V input voltage range. The TPSM83100 and TPSM83101 provide a power supply solution for system pre-regulators and voltage stabilizers.

Depending on the input voltage, the TPSM83100 and TPSM83101 automatically operate in boost, buck, or in 3-cycle buck-boost mode when the input voltage is approximately equal to the output voltage. The transitions between modes happen at a defined duty cycle and avoid unwanted toggling within the modes to reduce output voltage ripple. 8- μ A quiescent current and power save mode enable the highest efficiency for light to no-load conditions.

Package Information

Part Number	Package ⁽¹⁾	Body Size (NOM)
TPSM83100	μ SiP (8)	2.0 mm × 2.6 mm
TPSM83101 ⁽²⁾		

- (1) For all available packages, see the orderable addendum at the end of the data sheet.
- (2) Product Preview. Contact TI factory for more information.

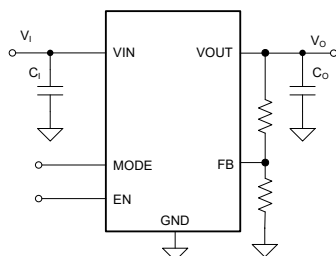

Typical Application

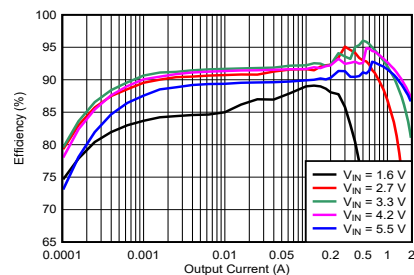

Efficiency vs Output Current ($V_{OUT} = 3.3$ V)



Table of Contents

1 Features	1	8.4 Device Functional Modes.....	10
2 Applications	1	9 Application and Implementation	11
3 Description	1	9.1 Application Information.....	11
4 Revision History	2	9.2 Typical Application.....	11
5 Device Comparison Table	3	9.3 Power Supply Recommendations.....	17
6 Pin Configuration and Functions	4	9.4 Layout.....	17
7 Specifications	5	10 Device and Documentation Support	18
7.1 Absolute Maximum Ratings.....	5	10.1 Device Support	18
7.2 ESD Rating.....	5	10.2 Receiving Notification of Documentation Updates..	18
7.3 Recommended Operating Conditions.....	5	10.3 Support Resources.....	18
7.4 Thermal Information.....	5	10.4 Trademarks.....	18
7.5 Electrical Characteristics	6	10.5 Electrostatic Discharge Caution.....	18
8 Detailed Description	7	10.6 Glossary.....	18
8.1 Overview.....	7	11 Mechanical, Packaging, and Orderable	
8.2 Functional Block Diagram.....	7	Information	19
8.3 Feature Description	7		

4 Revision History

NOTE: Page numbers for previous revisions may differ from page numbers in the current version.

Changes from Revision * (March 2023) to Revision A (June 2023)	Page
• Changed document status from Advance Information to Production Data.....	1
• Initial release	1

5 Device Comparison Table

PART NUMBER	Output Discharge
TPSM83100	No
TPSM83101 ⁽¹⁾	Yes

(1) Product Preview. Contact TI factory for more information.

6 Pin Configuration and Functions

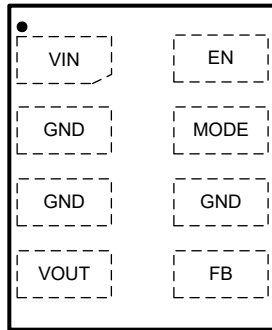

Figure 6-1. 8-Pin μ SiP package (Top View)

Table 6-1. Pin Functions

PIN		I/O ⁽¹⁾	DESCRIPTION
NAME	NO.		
VIN	1	PWR	Supply input voltage
GND	2	PWR	Power ground
GND	3	PWR	Power ground
VOUT	4	PWR	Power stage output
FB	5	I	Voltage feedback. Sensing pin
GND	6	PWR	Power ground
MODE	7	I	PFM/PWM selection. Set low for power save mode, set high for forced PWM. It must not be left floating.
EN	8	I	Device enable. Set high to enable and low to disable. It must not be left floating.

(1) PWR = power, I = input

7 Specifications

7.1 Absolute Maximum Ratings

over operating junction temperature range (unless otherwise noted)⁽¹⁾

		MIN	MAX	UNIT
V _I	Input voltage (V _{IN} , V _{OUT} , EN, FB, MODE) ⁽²⁾	-0.3	6.0	V
V _I	Input voltage for less than 10 ns	-0.3	7.0	V
T _J	Operating junction temperature	-40	150	°C
T _{stg}	Storage temperature	-65	150	°C

- Operation outside the Absolute Maximum Ratings may cause permanent device damage. Absolute Maximum Ratings do not imply functional operation of the device at these or any other conditions beyond those listed under Recommended Operating Conditions. If used outside the Recommended Operating Conditions but within the Absolute Maximum Ratings, the device may not be fully functional, and this may affect device reliability, functionality, performance, and shorten the device lifetime.
- All voltage values are with respect to network ground terminal, unless otherwise noted.

7.2 ESD Rating

			VALUE	UNIT
V _(ESD)	Electrostatic discharge	Human-body model (HBM), per ANSI/ESDA/JEDEC JS-001 ⁽¹⁾	±1000	V
		Charged-device model (CDM), per JEDEC specification JS-002 ⁽²⁾	± 500	

- JEDEC document JEP155 states that 500-V HBM allows safe manufacturing with a standard ESD control process.
- JEDEC document JEP157 states that 250-V CDM allows safe manufacturing with a standard ESD control process.

7.3 Recommended Operating Conditions

over operating junction temperature (unless otherwise noted)

			MIN	NOM	MAX	UNIT
V _I	Supply voltage		1.6		5.5	V
V _O	Output voltage		1.2		5.5	V
C _I	Input effective capacitance	V _I = 1.6 V to 5.5 V	4.2			μF
C _O	Output effective capacitance	1.2 V ≤ V _O ≤ 3.6 V, nominal value at V _O = 3.3 V	10.4	16.9	330	μF
		3.6 V < V _O ≤ 5.5 V, nominal value at V _O = 5 V	7.95	10.6	330	μF
T _J	Operating junction temperature range		-40		125	°C

7.4 Thermal Information

over operating free-air temperature range (unless otherwise noted)

	THERMAL METRIC	TPSM83100 TPSM83101	TPSM83100 TPSM83101	UNIT
		μSiP-8 PINS	μSiP-8 PINS	
		Standard	EVM	
R _{ΘJA}	Junction-to-ambient thermal resistance	100	48.9	°C/W
R _{ΘJC(top)}	Junction-to-case (top) thermal resistance	42.2	N/A	°C/W
R _{ΘJB}	Junction-to-board thermal resistance	33.2	N/A	°C/W
Ψ _{JT}	Junction-to-top characterization parameter	N/A	N/A	°C/W
Ψ _{JB}	Junction-to-board characterization parameter	32.2	24.5	°C/W

7.5 Electrical Characteristics

Over operating junction temperature range and recommended supply voltage range (unless otherwise noted). Typical values are at $V_I = 3.8\text{ V}$, $V_O = 3.3\text{ V}$ and $T_J = 25^\circ\text{C}$ (unless otherwise noted).

PARAMETER		TEST CONDITIONS		MIN	TYP	MAX	UNIT	
SUPPLY								
I_{SD}	Shutdown current into VIN	$V_I = 3.8\text{ V}$, $V_{(EN)} = 0\text{ V}$		$T_J = 25^\circ\text{C}$		0.5	0.9	μA
I_Q	Quiescent current into VIN	$V_I = 2.2\text{ V}$, $V_O = 3.3\text{ V}$, $V_{(EN)} = 2.2\text{ V}$, no switching		0.15	6.1		μA	
I_Q	Quiescent current into VOUT	$V_I = 2.2\text{ V}$, $V_O = 3.3\text{ V}$, $V_{(EN)} = 2.2\text{ V}$, no switching		8			μA	
V_{IT+}	Positive-going UVLO threshold voltage			1.5	1.55	1.599	V	
V_{IT-}	Negative-going UVLO threshold voltage	During start-up		1.4	1.45	1.499	V	
V_{hys}	UVLO threshold voltage hysteresis			99			mV	
$V_{I(POR)T+}$	Positive-going POR threshold voltage	maximum of V_I or V_O		1.25	1.45	1.65	V	
$V_{I(POR)T-}$	Negative-going POR threshold voltage			1.22	1.43	1.6	V	
I/O SIGNALS								
V_{T+}	Positive-going threshold voltage	EN, MODE		0.77	0.98	1.2	V	
V_{T-}	Negative-going threshold voltage	EN, MODE		0.5	0.66	0.76	V	
V_{hys}	Hysteresis voltage	EN, MODE		300			mV	
I_{IH}	High-level input current	EN, MODE	$V_{(EN)} = V_{(MODE)} = 1.5\text{ V}$, no pullup resistor	± 0.01	± 0.25		μA	
I_{IL}	Low-level input current	EN, MODE	$V_{(EN)} = V_{(MODE)} = 0\text{ V}$	± 0.01	± 0.1		μA	
	Input bias current	EN, MODE	$V_{(EN)} = 5.5\text{ V}$	± 0.01	± 0.3		μA	
POWER SWITCH								
$r_{DS(on)}$	On-state resistance	Q1	$V_I = 3.8\text{ V}$, $V_O = 3.3\text{ V}$, test current = 0.2 A	45			m Ω	
		Q2		50			m Ω	
		Q3		50			m Ω	
		Q4		85			m Ω	
CURRENT LIMIT								
$I_{L(PEAK)}$	Switch peak current limit ⁽¹⁾	Q1	$V_O = 3.3\text{ V}$	Output sourcing current	2.6	3	3.35	A
				Output sinking current, $V_I = 3.3\text{ V}$	-0.7	-0.55	-0.45	A
	PFM mode entry threshold (peak) current ⁽¹⁾		I_O falling	145			mA	
OUTPUT								
I_{DIS}	TPSM83101 output discharge current	EN = LOW, $V_I = 2.2\text{ V}$ $V_O = 3.3\text{ V}$		-67			mA	
V_{FB}	Reference voltage on feedback pin			495	500	505	mV	
PROTECTION FEATURES								
$V_{T+(OVP)}$	Positive-going OVP threshold voltage			5.55	5.75	5.95	V	
$V_{T+(IVP)}$	Positive-going IVP threshold voltage			5.55	5.75	5.95	V	
T_{JT+}	Thermal shutdown threshold temperature	T_J rising		160			$^\circ\text{C}$	
	Thermal shutdown hysteresis			25			$^\circ\text{C}$	
TIMING PARAMETERS								
$t_{d(EN)}$	Delay between a rising edge on the EN pin and the start of the output voltage ramp			0.87	1.5		ms	
$t_{d(ramp)}$	Soft-start ramp time			6.42	7.55	8.68	ms	
f_{SW}	Switching frequency			1.8	2	2.2	MHz	

(1) Current limit production test are performed under DC conditions. The current limit in operation is somewhat higher and depends on propagation delay and the applied external components

8 Detailed Description

8.1 Overview

The TPSM83100 and TPSM83101 are constant frequency peak current mode control buck-boost MicroSiP™ power modules. The modules use a fixed-frequency topology with approximately 2-MHz switching frequency. The modulation scheme has three clearly defined operation modes where the modules enter with defined thresholds over the full operation range of V_{IN} and V_{OUT} . The maximum output current is determined by the Q1 peak current limit which is typically 3 A and by the thermal limitation.

8.2 Functional Block Diagram

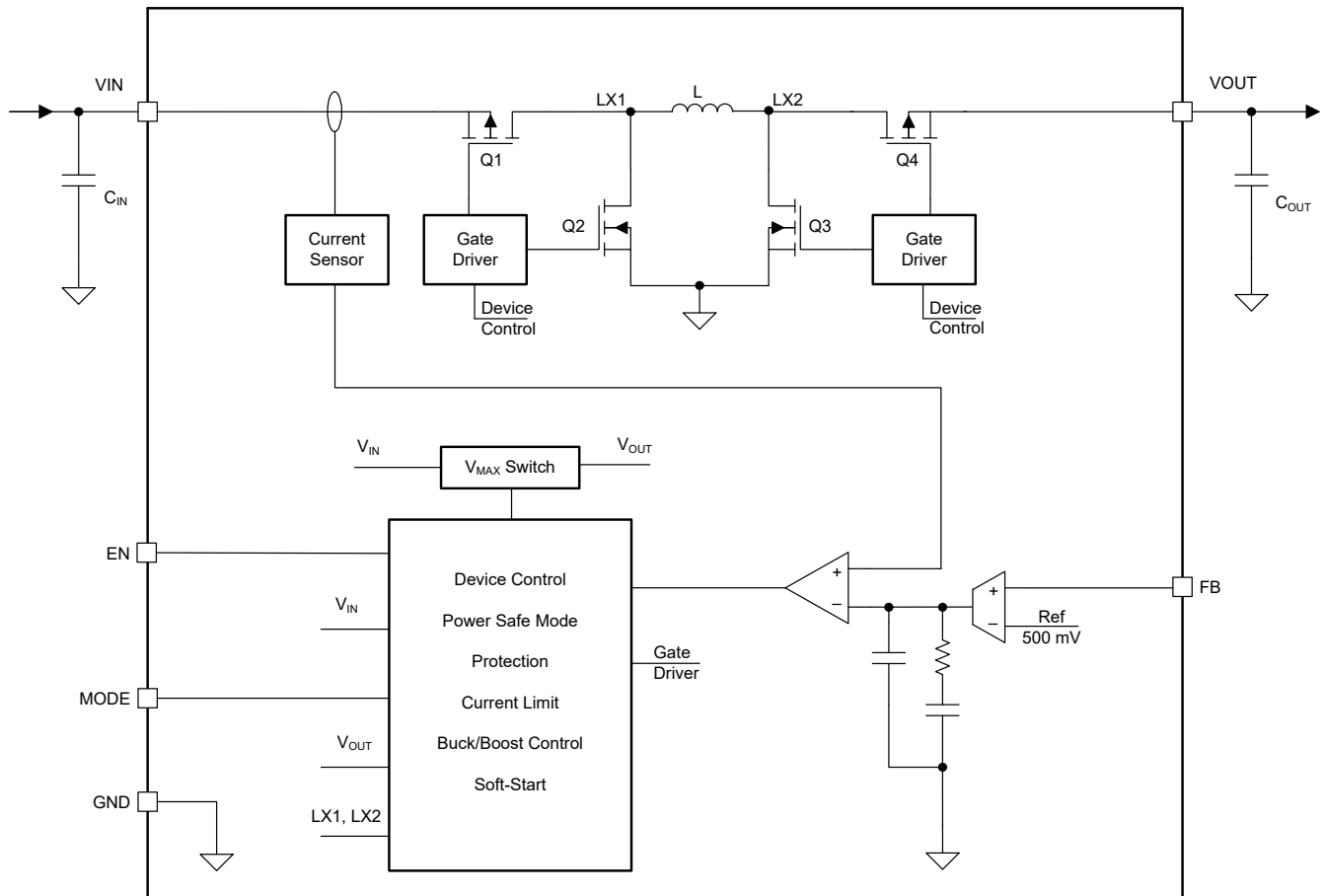

8.3 Feature Description

8.3.1 Undervoltage Lockout (UVLO)

The input voltage of the VIN pin is continuously monitored if the device is not in shutdown mode. UVLO only stops or starts the module operation. The UVLO does not impact the core logic of the device. UVLO avoids a brownout of the device during device operation. In case the supply voltage on the VIN pin is lower than the negative-going threshold of UVLO, the module stops its operation. To avoid a false disturbance of the power conversion, the UVLO falling threshold logic signal is digitally de-glitched.

If the supply voltage on the VIN pin recovers to be higher than the UVLO rising threshold, the module returns to operation. In this case, the soft-start procedure restarts faster than under start-up without a pre-biased output.

8.3.2 Enable and Soft Start

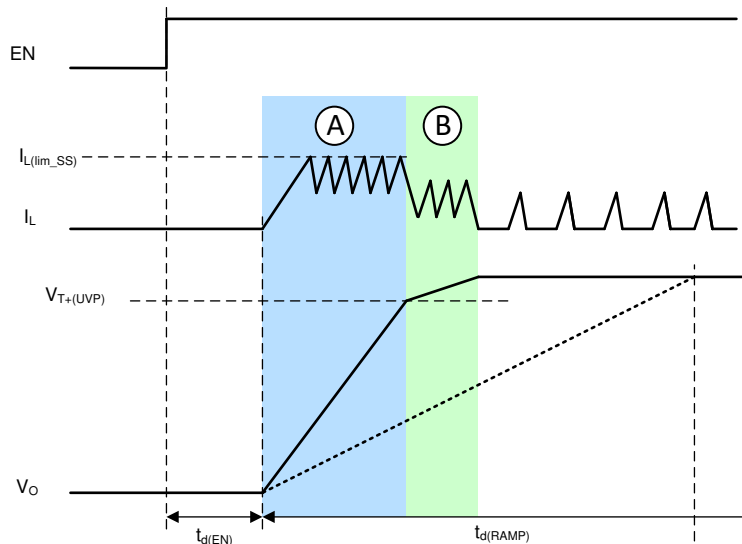

Figure 8-1. Typical Soft-Start Behavior

When the input voltage is above the UVLO rising threshold and the EN pin is pulled to a voltage above 1.2 V, the TPSM83100 and TPSM83101 are enabled and start up after a short delay time, $t_{d(EN)}$.

The TPSM83100 and TPSM83101 have an inductor peak current clamp to limit inrush current during start-up. When the minimum current clamp ($I_{L(lim_SS)}$) is lower than the current that is necessary to follow the voltage ramp, the current automatically increases to follow the voltage ramp. The minimum current limit ensures as fast as possible soft start if the capacitance is chosen lower than what the ramp time $t_{d(RAMP)}$ was selected for.

In a typical start-up case as shown in [Figure 8-1](#) (low output load, typical output capacitance), the minimum current clamp limits the inrush current and charges the output capacitor. The output voltage then rises faster than the reference voltage ramp (see phase A in [Figure 8-1](#)). To avoid an output overshoot, the current clamp is deactivated when the output is close to the target voltage and follows the reference voltage ramp slew value given by the voltage ramp, which is finishing the start up (see phase B in [Figure 8-1](#)). The transition from the minimum current clamp operation is sensed by using the threshold $V_{T+(UVP)}$. After phase B, the output voltage is well regulated to the nominal target voltage. The current waveform depends on the output load and operation mode.

8.3.3 Adjustable Output Voltage

The output voltage is set by an external resistor divider. The resistor divider must be connected between VOUT, FB, and GND. The feedback voltage is given by V_{FB} . The recommended low-side resistor R2 (between FB and GND) is below 100 kΩ. The high-side resistor R1 (between FB and VOUT) is calculated by [Equation 1](#).

$$R1 = R2 \times (V_{OUT} / V_{FB} - 1) \quad (1)$$

The typical V_{FB} voltage is 0.5 V.

8.3.4 Mode Selection (PFM/FPWM)

The mode pin is a digital input to enable PFM/FPWM.

When the MODE pin is connected to logic low, the device works in auto PFM mode. The device features a power save mode to maintain the highest efficiency over the full operating output current range. PFM automatically changes the converter operation from CCM to pulse frequency modulation.

When the MODE pin is connected to logic high, the device works in forced PWM mode, regardless of the output current, to achieve minimum output ripple.

8.3.5 Output Discharge

TPSM83101 provides an active pull down current(67mA typ) to quickly discharge output when the EN is logic low. With this function, the V_{OUT} is connected to ground through internal circuitry, preventing the output from “floating” or entering into an undetermined state. The output discharge function makes the power on and off sequencing smooth. Pay attention to the output discharge function if use this device in applications such as power multiplexing, because the output discharge circuitry creates a constant current path between the multiplexer output and the ground.

8.3.6 Reverse Current Operation

The device can support reverse current operation (the current flows from V_{OUT} pin to V_{IN} pin) in FPWM mode. If the output feedback voltage on the FB pin is higher than the reference voltage, the module regulation forces a current into the input capacitor. The reverse current operation is independent of the V_{IN} voltage or V_{OUT} voltage ratio, hence it is possible on all device operation modes boost, buck, or buck-boost.

8.3.7 Protection Features

The following sections describe the protection features of the device.

8.3.7.1 Input Overvoltage Protection

The TPSM83100 and TPSM83101 have input overvoltage protection which avoids any damage to the device in case the current flows from the output to the input and the input source cannot sink current (for example, a diode in the supply path).

If forced PWM mode is active, the current can go negative until it reaches the sink current limit. Once the input voltage threshold, V_{T+(IVP)}, is reached on the V_{IN} pin, the protection disables forced PWM mode and only allows current to flow from V_{IN} to V_{OUT}. After the input voltage drops under the input voltage protection threshold, forced PWM mode can be activated again.

8.3.7.2 Output Overvoltage Protection

The TPSM83100 and TPSM83101 have the output overvoltage protection which avoids any damage to the device in case the external feedback pin is not working properly.

When the output voltage threshold V_{T+(OVP)} is reached at the V_{OUT} pin, the protection disables the module power stage and makes the switching nodes high impedance.

8.3.7.3 Short Circuit Protection

The device features peak current limit performance at short circuit protection. [Figure 8-2](#) shows a typical device behavior of an short/overload event of the short circuit protection.

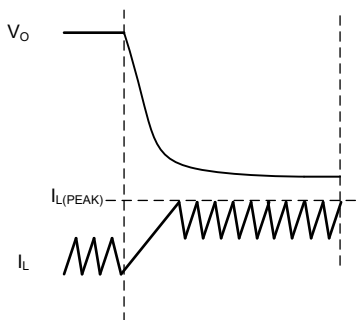

Figure 8-2. Typical Device Behavior During Short Circuit Protection

8.3.7.4 Thermal Shutdown

To avoid thermal damage of the device, the temperature of the die is monitored. The device stops operation once the sensed temperature rises over the typical thermal threshold 160 °C. After the temperature drops below the typical thermal shutdown hysteresis 25 °C, the module returns to normal operation.

8.4 Device Functional Modes

The device has two functional modes: off and on. The device enters the on mode when the voltage on the VIN pin is higher than the UVLO threshold and a high logic level is applied to the EN pin. The device enters the off mode when the voltage on the VIN pin is lower than the UVLO threshold or a low logic level is applied to the EN pin.

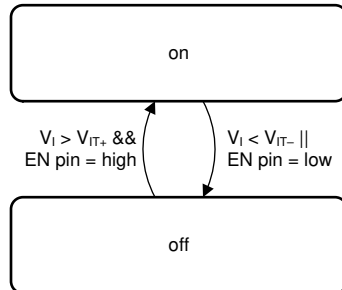

Figure 8-3. Device Functional Modes

9 Application and Implementation

Note

Information in the following applications sections is not part of the TI component specification, and TI does not warrant its accuracy or completeness. TI's customers are responsible for determining suitability of components for their purposes, as well as validating and testing their design implementation to confirm system functionality.

9.1 Application Information

The TPSM83100 and TPSM83101 are high-efficiency, low-quiescent current, buck-boost modules. The devices are suitable for applications needing a regulated output voltage from an input supply that can be higher or lower than the output voltage.

9.2 Typical Application

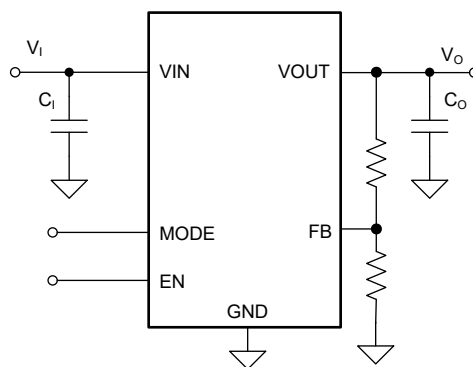

Figure 9-1. 3.3-V_{OUT} Typical Application

9.2.1 Design Requirements

The design parameters are listed in [Table 9-1](#).

Table 9-1. Design Parameters

PARAMETERS	VALUES
Input voltage	2.7 V to 4.3 V
Output voltage	3.3 V
Output current	1.0 A

9.2.2 Detailed Design Procedure

The first step is the selection of the output filter components. To simplify this process, Recommended Operating Conditions outlines minimum and maximum values for capacitance. Pay attention to the tolerance and derating when selecting nominal capacitance.

9.2.2.1 Output Capacitor Selection

For the output capacitor, use small ceramic capacitors placed as close as possible to the VOUT and PGND pins of the module. The recommended total nominal output capacitor value is 47 μ F. If, for any reason, the application requires the use of large capacitors that cannot be placed close to the module, use a smaller ceramic capacitor in parallel to the large capacitor, and place the small capacitor as close as possible to the VOUT and PGND pins of the module.

It is important that the effective capacitance is given according to the recommended value in Recommended Operating Conditions. In general, consider DC bias effects resulting in less effective capacitance. The choice of the output capacitance is mainly a tradeoff between size and transient behavior as higher capacitance reduces transient response over/undershoot and increases transient response time. Possible output capacitors are listed in [Table 9-2](#).

Table 9-2. List of Recommended Capacitors

CAPACITOR VALUE [μ F]	VOLTAGE RATING [V]	ESR [m Ω]	PART NUMBER	MANUFACTURER ⁽¹⁾	SIZE (METRIC)
47	6.3	10	GRM219R60J476ME44	Murata	0805 (2012)
47	10	40	CL10A476MQ8QRN	Semco	0603 (1608)

(1) See the [Third-Party Products Disclaimer](#).

9.2.2.2 Input Capacitor Selection

A 22- μ F input capacitor is recommended to improve line transient behavior of the regulator and EMI behavior of the total power supply circuit. An X5R or X7R ceramic capacitor placed as close as possible to the VIN and PGND pins of the module is recommended. This capacitance can be increased without limit. If the input supply is located more than a few inches from the TPSM83100, additional bulk capacitance can be required in addition to the ceramic bypass capacitors. An electrolytic or tantalum capacitor with a value of 47 μ F is a typical choice.

Table 9-3. List of Recommended Capacitors

CAPACITOR VALUE [μ F]	VOLTAGE RATING [V]	ESR [m Ω]	PART NUMBER	MANUFACTURER ⁽¹⁾	SIZE (METRIC)
22	6.3	43	GRM187R61A226ME15	Murata	0603 (1608)
10	10	40	GRM188R61A106ME69	Murata	0603 (1608)

(1) See the [Third-Party Products Disclaimer](#).

9.2.2.3 Setting the Output Voltage

The output voltage is set by an external resistor divider. The resistor divider must be connected between VOUT, FB, and GND. The feedback voltage is 500 mV nominal.

Keep the low-side resistor R2 (between FB and GND) below 100 k Ω . The high-side resistor (between FB and VOUT) R1 is calculated with [Equation 2](#).

$$R1 = R2 \times \left(\frac{V_{OUT}}{V_{FB}} - 1 \right) \quad (2)$$

where $V_{FB} = 500$ mV.

Table 9-4. Resistor Selection For Typical Output Voltages

V _{OUT}	R1	R2
2.5 V	365 K	91 K
3.3 V	511 K	91 K
3.6 V	562 K	91 K
5.0 V	806 K	91 K

9.2.3 Application Curves

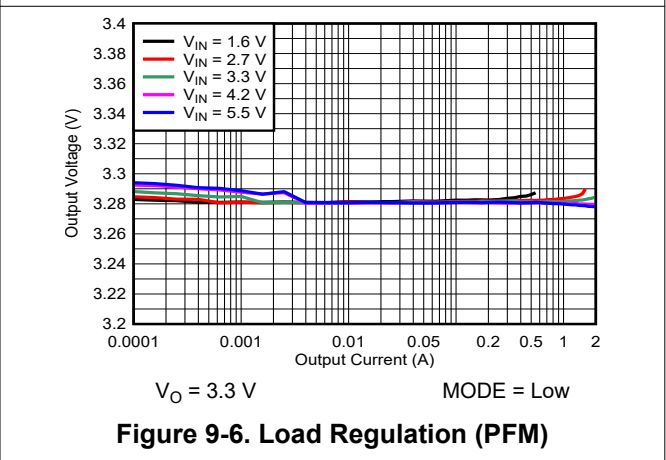
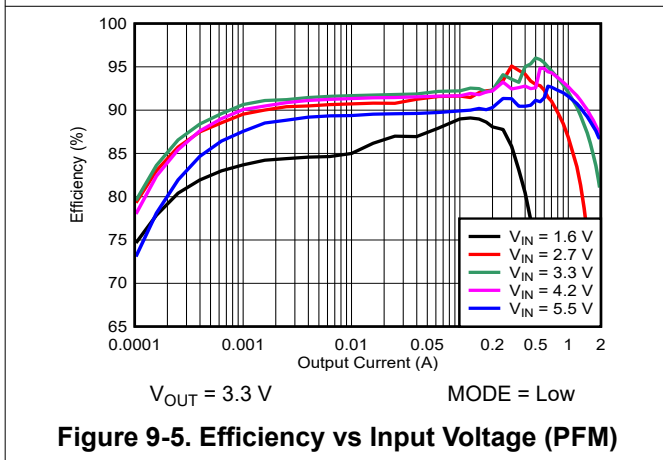
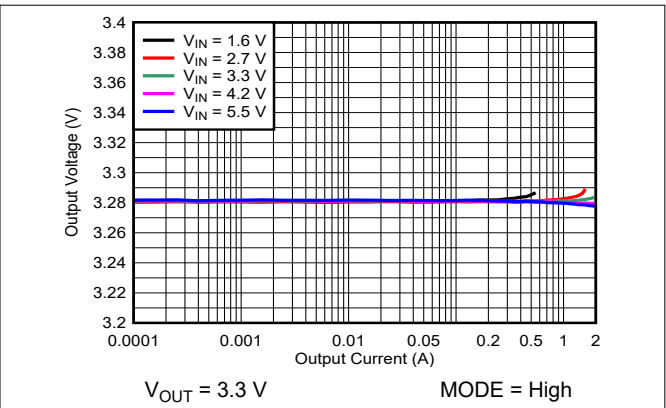
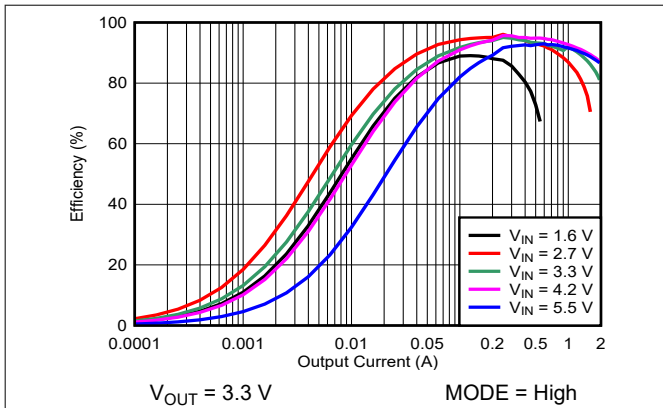
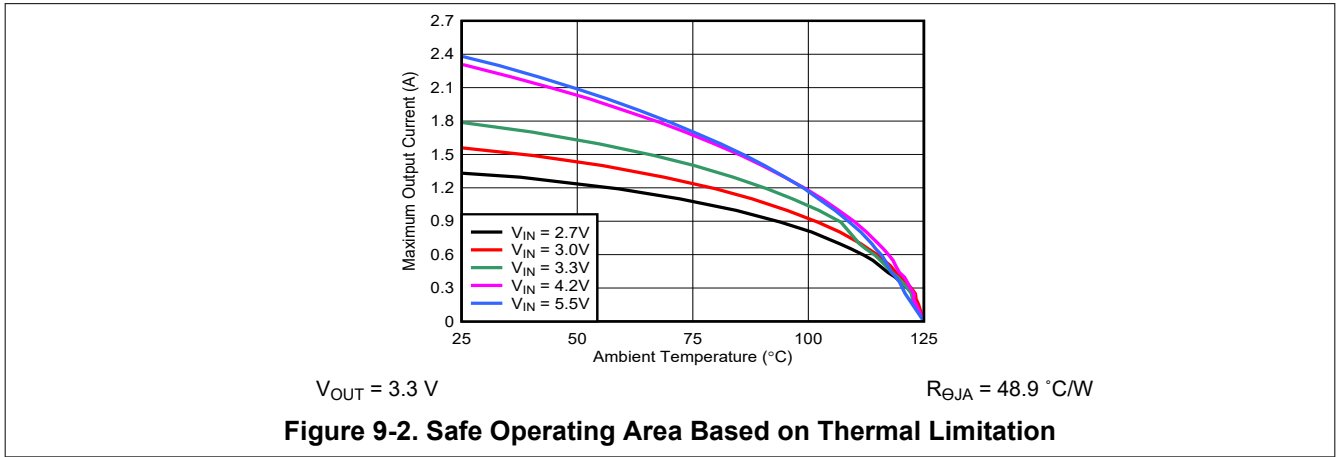

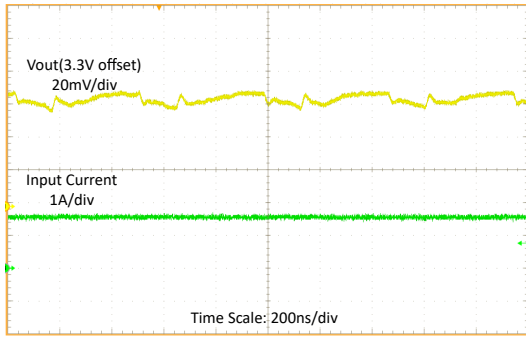

$V_{IN} = 2.7\text{ V}$, $V_{OUT} = 3.3\text{ V}$ $I_{OUT} = 1\text{ A}$, MODE = Low

Figure 9-7. Steady State Waveforms, Boost Operation with 1-A Load

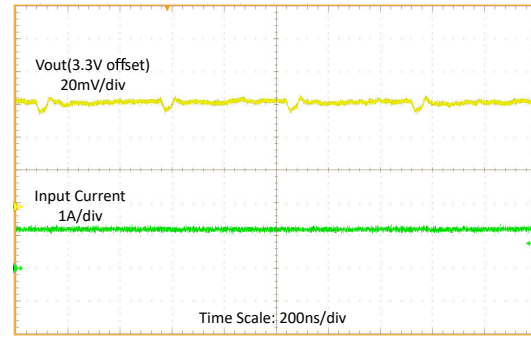

$V_{IN} = 3.3\text{ V}$, $V_{OUT} = 3.3\text{ V}$ $I_{OUT} = 1\text{ A}$, MODE = Low

Figure 9-8. Steady State Waveforms, Buck-Boost with 1-A Load

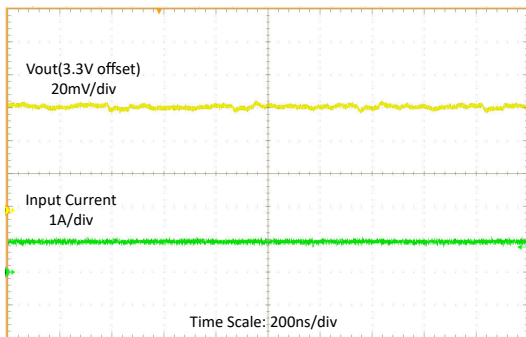

$V_{IN} = 4.3\text{ V}$, $V_{OUT} = 3.3\text{ V}$ $I_{OUT} = 1\text{ A}$, MODE = Low

Figure 9-9. Steady State Waveforms, Buck Operation with 1-A Load

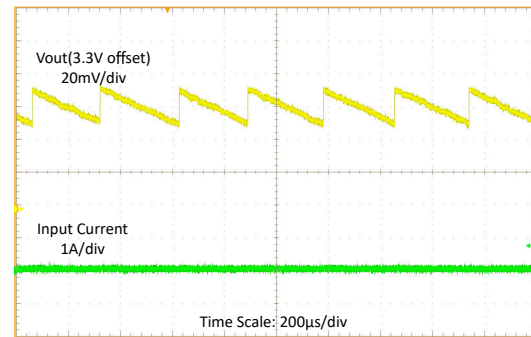

$V_{IN} = 3.6\text{ V}$, $V_{OUT} = 3.3\text{ V}$ $I_{OUT} = 1\text{ mA}$, MODE = Low

Figure 9-10. Steady State Waveforms, with 1-mA Load

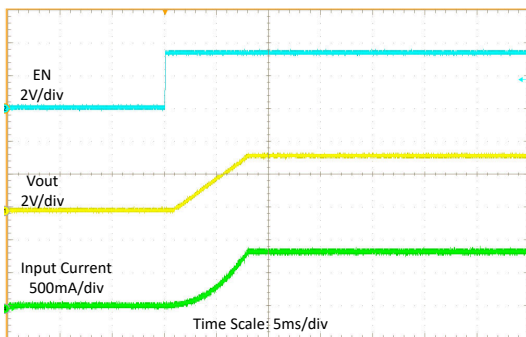

$V_{IN} = 3.6\text{ V}$, $V_{OUT} = 3.3\text{ V}$ $R_{load} = 4\ \Omega$, MODE = Low

Figure 9-11. Start-Up by EN

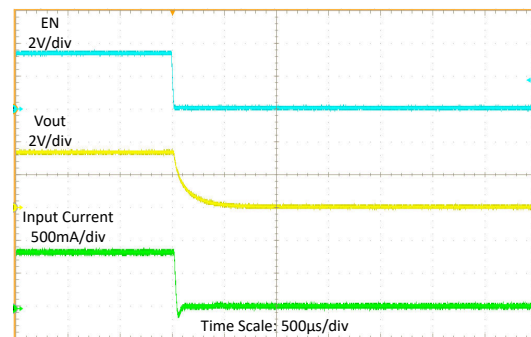

$V_{IN} = 3.6\text{ V}$, $V_{OUT} = 3.3\text{ V}$ $R_{load} = 4\ \Omega$, MODE = Low

Figure 9-12. Shutdown by EN

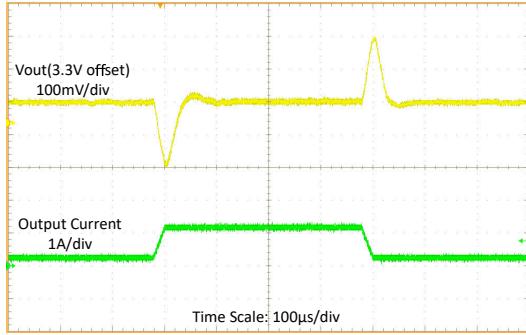

$V_{IN} = 2.7\text{ V}$, $V_{OUT} = 3.3\text{ V}$ $I_{OUT} = 100\text{ mA to }1\text{ A}$ with $20\text{-}\mu\text{s}$ slew rate

Figure 9-13. Load Transient at 2.7-V Input Voltage

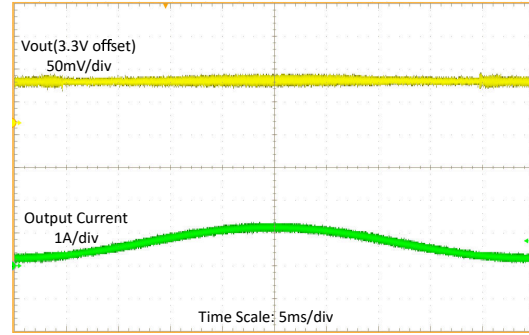

$V_{IN} = 2.7\text{ V}$, $V_{OUT} = 3.3\text{ V}$ $I_{OUT} = 100\text{ mA to }1\text{-A sweep}$

Figure 9-14. Load Sweep at 2.7-V Input Voltage

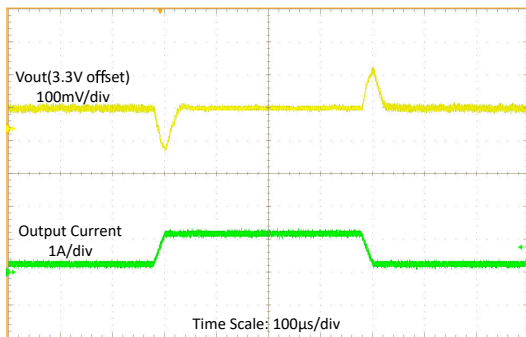

$V_{IN} = 3.6\text{ V}$, $V_{OUT} = 3.3\text{ V}$ $I_{OUT} = 100\text{ mA to }1\text{ A}$ with $20\text{-}\mu\text{s}$ slew rate

Figure 9-15. Load Transient at 3.6-V Input Voltage

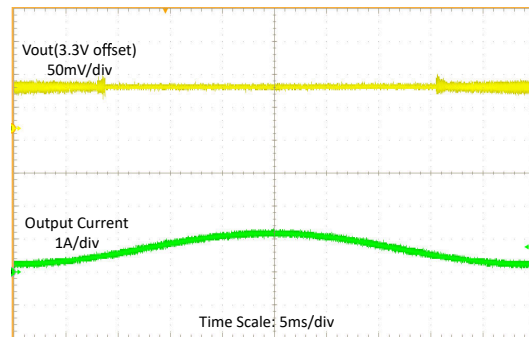

$V_{IN} = 3.6\text{ V}$, $V_{OUT} = 3.3\text{ V}$ $I_{OUT} = 100\text{ mA to }1\text{-A sweep}$

Figure 9-16. Load Sweep at 3.6-V Input Voltage

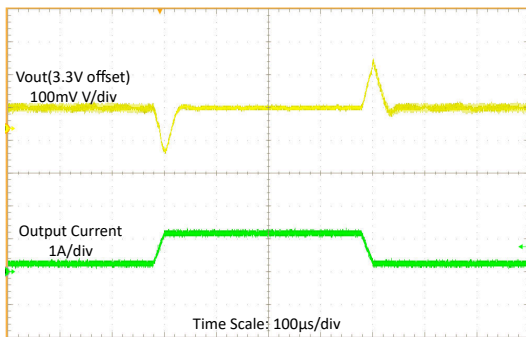

$V_{IN} = 4.3\text{ V}$, $V_{OUT} = 3.3\text{ V}$ $I_{OUT} = 100\text{ mA to }1\text{ A}$ with $20\text{-}\mu\text{s}$ slew rate

Figure 9-17. Load Transient at 4.3-V Input Voltage

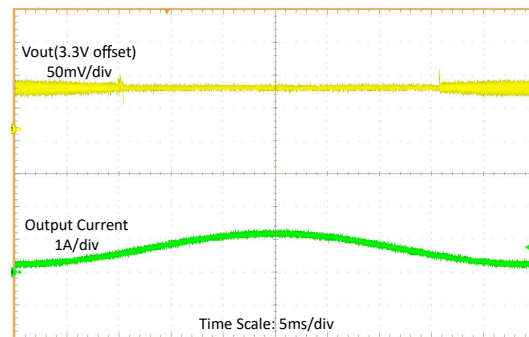

$V_{IN} = 4.3\text{ V}$, $V_{OUT} = 3.3\text{ V}$ $I_{OUT} = 100\text{ mA to }1\text{-A sweep}$

Figure 9-18. Load Sweep at 4.3-V Input Voltage

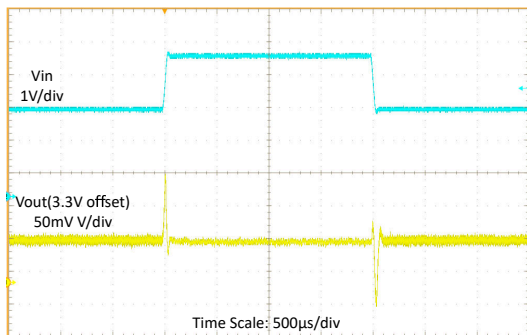
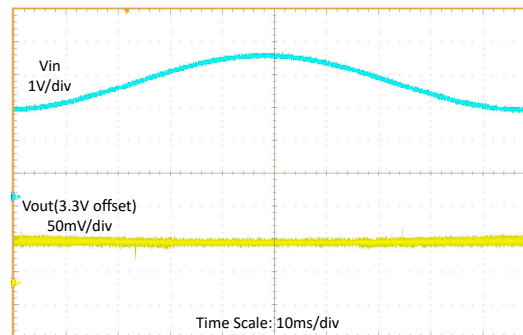
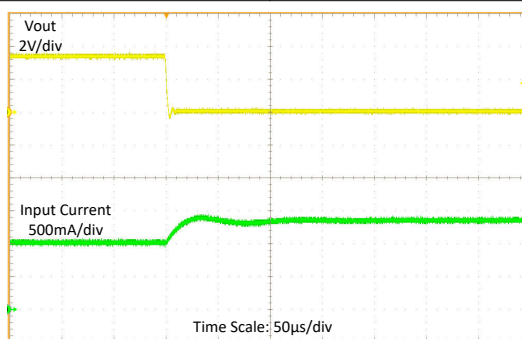
 $V_{IN} = 2.7\text{ V to }4.3\text{ V with }20\text{-}\mu\text{s}$ slew rate, $V_{OUT} = 3.3\text{ V}$ $I_{OUT} = 1\text{ A}$
Figure 9-19. Line Transient at 1-A Load Current

 $V_{IN} = 2.7\text{-V to }4.3\text{-V sweep,}$ $I_{OUT} = 1\text{ A}$
 $V_{OUT} = 3.3\text{ V}$
Figure 9-20. Line Sweep at 1-A Load Current

 $V_{IN} = 3.6\text{ V, }V_{OUT} = 3.3\text{ V}$ $I_{OUT} = 1\text{ A, FPWM}$
Figure 9-21. Output Short Protection (Entry)
Table 9-5. Components for Application Characteristic Curves for $V_{OUT} = 3.3\text{ V}$

REFERENCE	DESCRIPTION ⁽²⁾	PART NUMBER	MANUFACTURER ⁽¹⁾
U1	High Power Density 1.5 A Buck-Boost module	TPSM83100	Texas Instruments
C1	22 μF , 0603, Ceramic Capacitor, $\pm 20\%$, 6.3 V	GRM187R61A226ME15	Murata
C2	47 μF , 0805, Ceramic Capacitor, $\pm 20\%$, 6.3 V	GRM219R60J476ME44	Murata
R1	511 k Ω , 0603 Resistor, 1%, 100 mW	Standard	Standard
R2	91 k Ω , 0603 Resistor, 1%, 100 mW	Standard	Standard

 (1) See the [Third-Party Products Disclaimer](#).

(2) For other output voltages, refer to Resistor Selection for Typical Output Voltages for resistor values.

9.3 Power Supply Recommendations

The TPSM83100 and TPSM83101 have no special requirements for its input power supply. The input power supply output current needs to be rated according to the supply voltage, output voltage, and output current.

9.4 Layout

9.4.1 Layout Guidelines

The PCB layout is an important step to maintain the high performance of the TPSM83100 device.

- Place input and output capacitors as close as possible to the module. Traces need to be kept short. Route wide and direct traces to the input and output capacitors results in low trace resistance and low parasitic inductance.

9.4.2 Layout Example

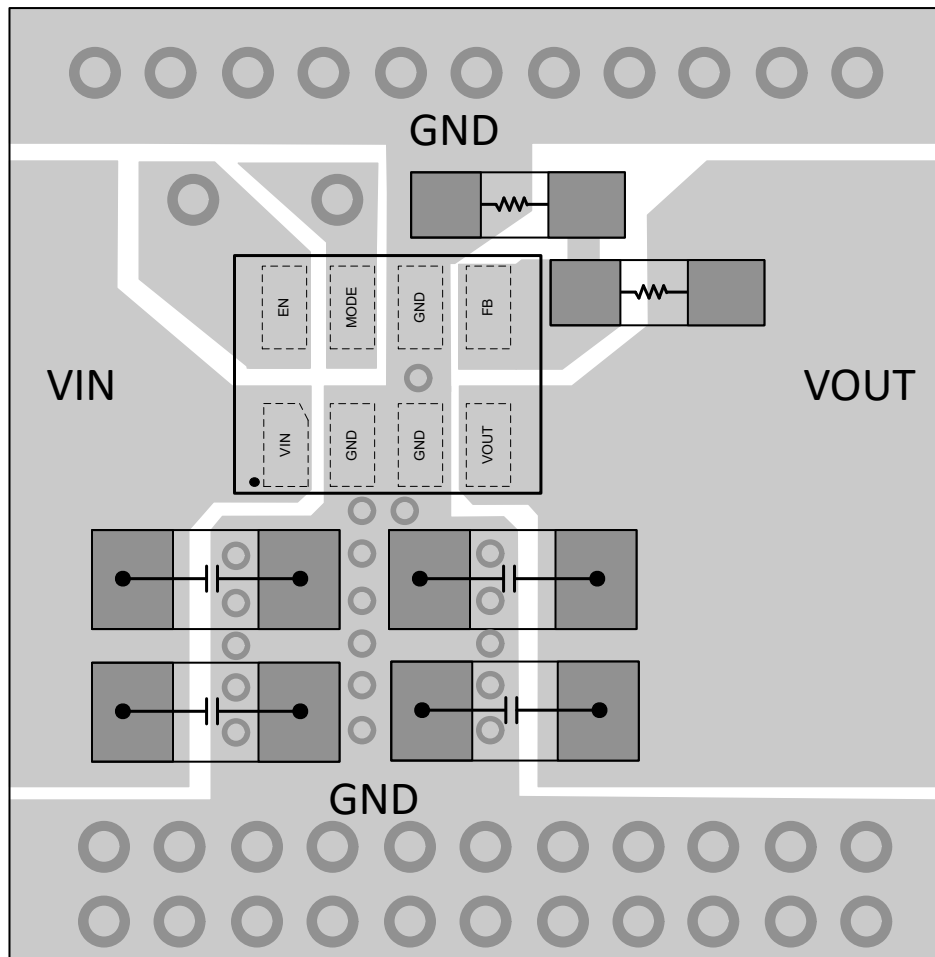

Figure 9-22. Layout Example

10 Device and Documentation Support

10.1 Device Support

10.1.1 Third-Party Products Disclaimer

TI'S PUBLICATION OF INFORMATION REGARDING THIRD-PARTY PRODUCTS OR SERVICES DOES NOT CONSTITUTE AN ENDORSEMENT REGARDING THE SUITABILITY OF SUCH PRODUCTS OR SERVICES OR A WARRANTY, REPRESENTATION OR ENDORSEMENT OF SUCH PRODUCTS OR SERVICES, EITHER ALONE OR IN COMBINATION WITH ANY TI PRODUCT OR SERVICE.

10.1.2 Development Support

10.1.2.1 Custom Design with WEBENCH Tools

[Click here](#) to create a custom design using the TPSM83100 and TPSM83101 devices with the WEBENCH® Power Designer.

1. Start by entering your V_{IN} , V_{OUT} and I_{OUT} requirements.
2. Optimize your design for key parameters like efficiency, footprint or cost using the optimizer dial and compare this design with other possible solutions from Texas Instruments.
3. WEBENCH Power Designer provides you with a customized schematic along with a list of materials with real time pricing and component availability.
4. In most cases, you can:
 - Run electrical simulations to see important waveforms and circuit performance,
 - Run thermal simulations to understand the thermal performance of your board,
 - Export your customized schematic and layout into popular CAD formats,
 - Print PDF reports for the design, and share your design with colleagues.
5. Get more information about WEBENCH tools at www.ti.com/webench.

10.2 Receiving Notification of Documentation Updates

To receive notification of documentation updates, navigate to the device product folder on ti.com. Click on *Subscribe to updates* to register and receive a weekly digest of any product information that has changed. For change details, review the revision history included in any revised document.

10.3 Support Resources

[TI E2E™ support forums](#) are an engineer's go-to source for fast, verified answers and design help — straight from the experts. Search existing answers or ask your own question to get the quick design help you need.

Linked content is provided "AS IS" by the respective contributors. They do not constitute TI specifications and do not necessarily reflect TI's views; see TI's [Terms of Use](#).

10.4 Trademarks

MicroSiP™ is a trademark of TI.

TI E2E™ are trademarks of Texas Instruments.

WEBENCH® is a registered trademark of Texas Instruments.

All trademarks are the property of their respective owners.

10.5 Electrostatic Discharge Caution



This integrated circuit can be damaged by ESD. Texas Instruments recommends that all integrated circuits be handled with appropriate precautions. Failure to observe proper handling and installation procedures can cause damage.

ESD damage can range from subtle performance degradation to complete device failure. Precision integrated circuits may be more susceptible to damage because very small parametric changes could cause the device not to meet its published specifications.

10.6 Glossary

[TI Glossary](#) This glossary lists and explains terms, acronyms, and definitions.

11 Mechanical, Packaging, and Orderable Information

The following pages include mechanical, packaging, and orderable information. This information is the most current data available for the designated devices. This data is subject to change without notice and revision of this document. For browser-based versions of this data sheet, refer to the left-hand navigation.

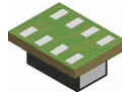

SIU0008A

PACKAGE OUTLINE
MicroSiP™ - 1.2 mm max height

MICRO SYSTEM IN PACKAGE

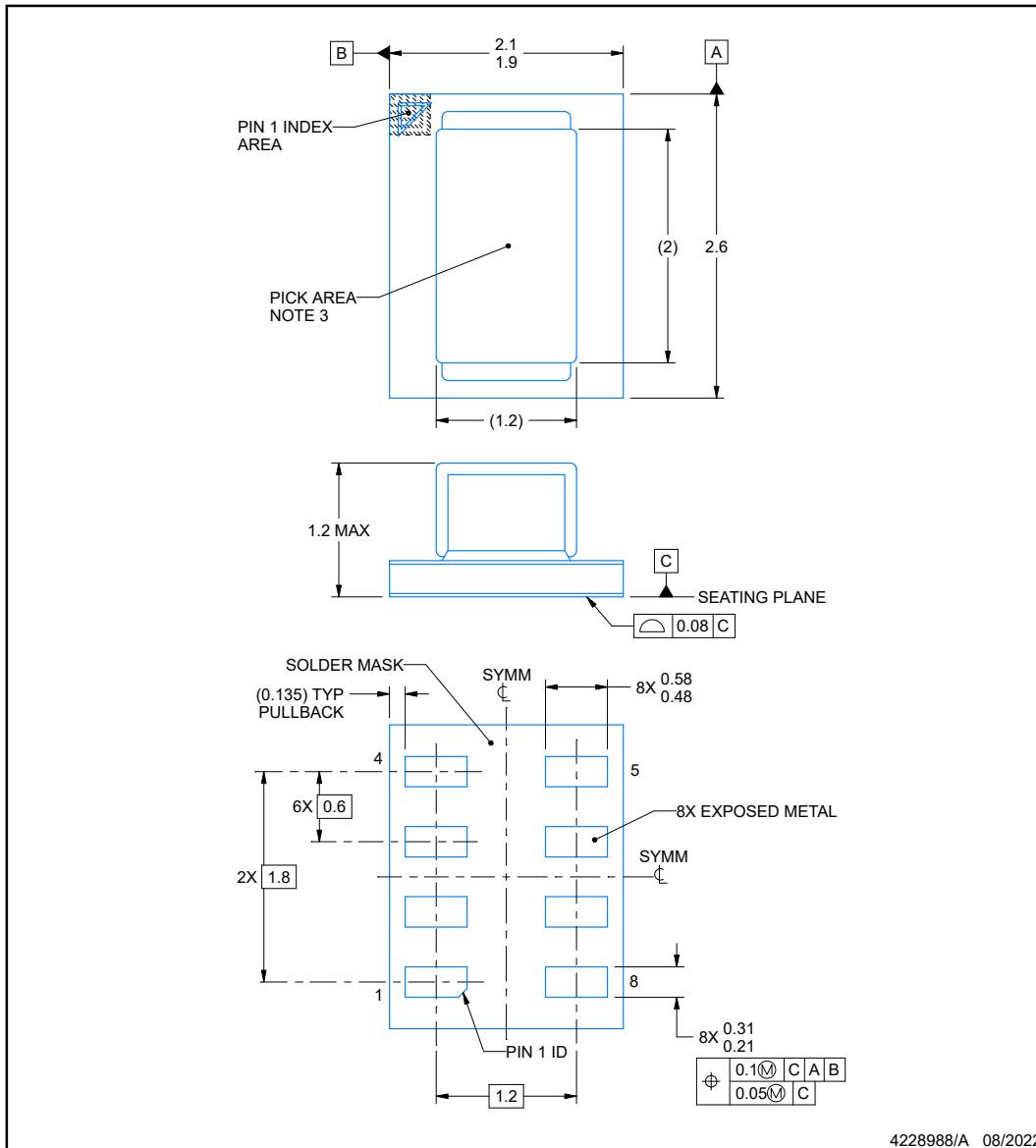

4228988/A 08/2022

NOTES:

MicroSiP is a trademark of Texas Instruments

1. All linear dimensions are in millimeters. Any dimensions in parenthesis are for reference only. Dimensioning and tolerancing per ASME Y14.5M.
2. This drawing is subject to change without notice.
3. Pick and place nozzle \varnothing 0.33 mm or smaller recommended.

EXAMPLE BOARD LAYOUT

SIU0008A

MicroSiP™ - 1.2 mm max height

MICRO SYSTEM IN PACKAGE

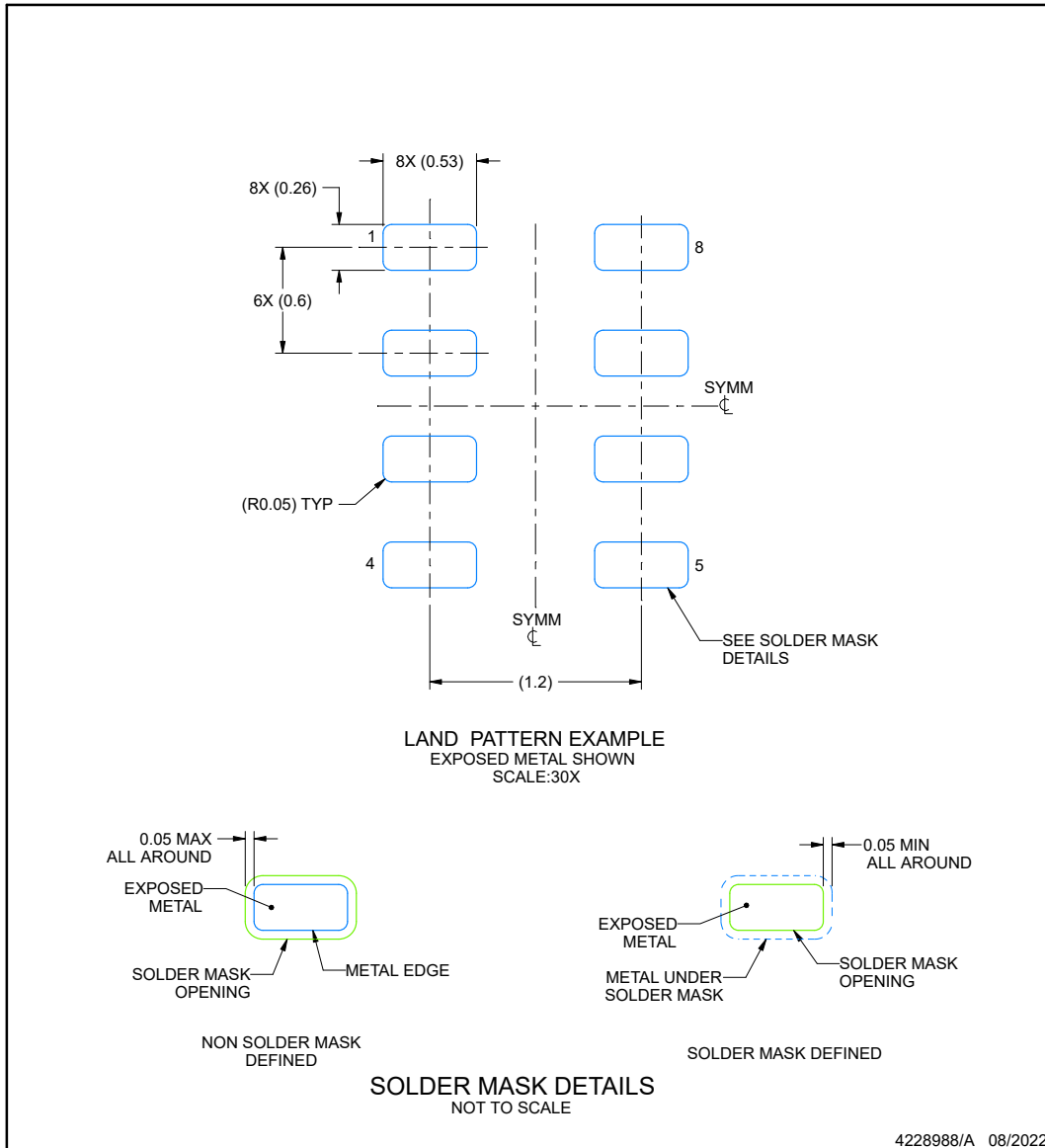

NOTES: (continued)

4. For more information, see Texas Instruments literature number SLUA271 (www.ti.com/lit/slua271).

EXAMPLE STENCIL DESIGN

SIU0008A

MicroSiP™ - 1.2 mm max height

MICRO SYSTEM IN PACKAGE

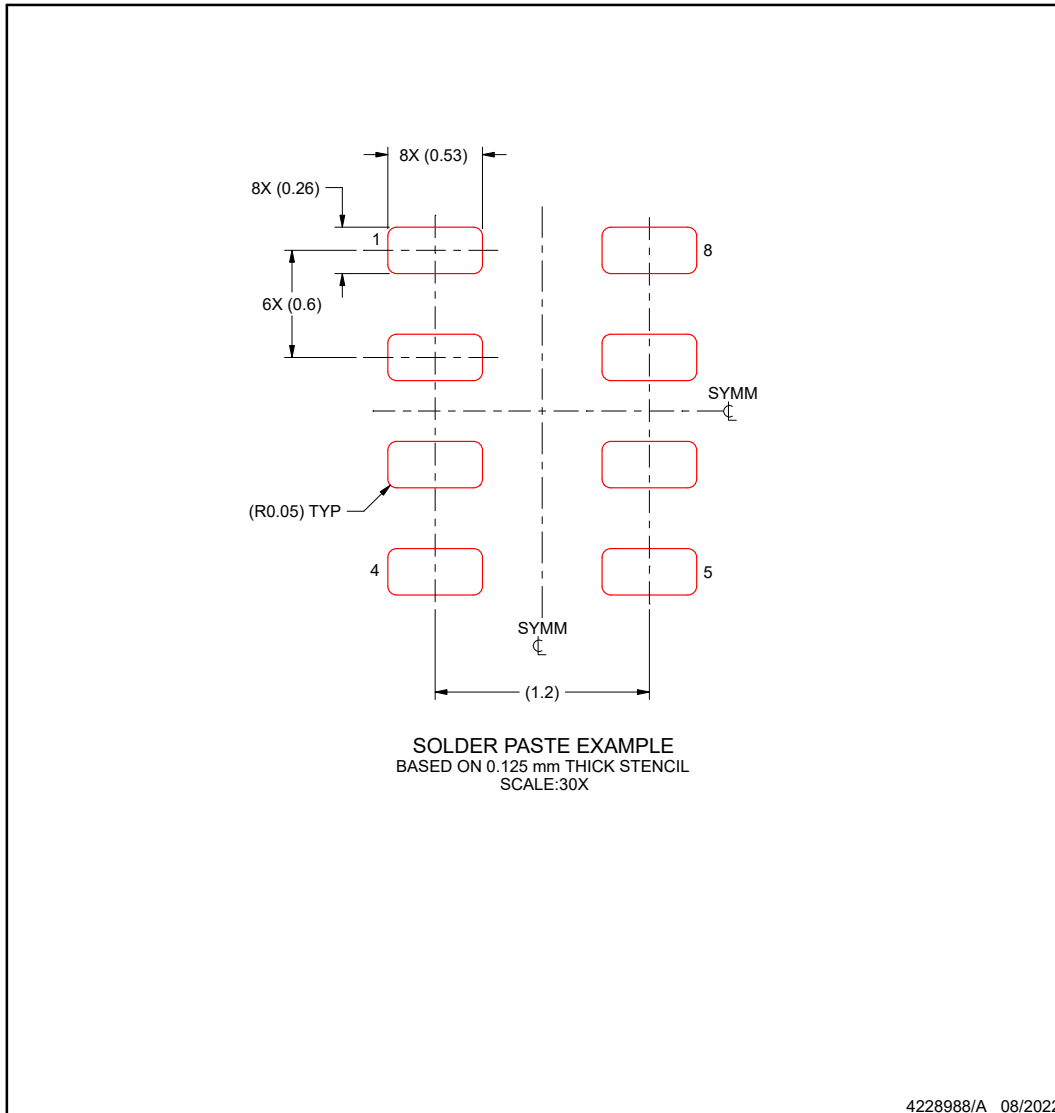

NOTES: (continued)

5. Laser cutting apertures with trapezoidal walls and rounded corners may offer better paste release. IPC-7525 may have alternate design recommendations.

PACKAGING INFORMATION

Orderable Device	Status (1)	Package Type	Package Drawing	Pins	Package Qty	Eco Plan (2)	Lead finish/ Ball material (6)	MSL Peak Temp (3)	Op Temp (°C)	Device Marking (4/5)	Samples
TPSM83100SIUR	ACTIVE	uSiP	SIU	8	3000	RoHS & Green	Call TI	Level-2-260C-1 YEAR	-40 to 125	31NL	Samples

(1) The marketing status values are defined as follows:

ACTIVE: Product device recommended for new designs.

LIFEBUY: TI has announced that the device will be discontinued, and a lifetime-buy period is in effect.

NRND: Not recommended for new designs. Device is in production to support existing customers, but TI does not recommend using this part in a new design.

PREVIEW: Device has been announced but is not in production. Samples may or may not be available.

OBSOLETE: TI has discontinued the production of the device.

(2) **RoHS:** TI defines "RoHS" to mean semiconductor products that are compliant with the current EU RoHS requirements for all 10 RoHS substances, including the requirement that RoHS substance do not exceed 0.1% by weight in homogeneous materials. Where designed to be soldered at high temperatures, "RoHS" products are suitable for use in specified lead-free processes. TI may reference these types of products as "Pb-Free".

RoHS Exempt: TI defines "RoHS Exempt" to mean products that contain lead but are compliant with EU RoHS pursuant to a specific EU RoHS exemption.

Green: TI defines "Green" to mean the content of Chlorine (Cl) and Bromine (Br) based flame retardants meet JS709B low halogen requirements of <=1000ppm threshold. Antimony trioxide based flame retardants must also meet the <=1000ppm threshold requirement.

(3) MSL, Peak Temp. - The Moisture Sensitivity Level rating according to the JEDEC industry standard classifications, and peak solder temperature.

(4) There may be additional marking, which relates to the logo, the lot trace code information, or the environmental category on the device.

(5) Multiple Device Markings will be inside parentheses. Only one Device Marking contained in parentheses and separated by a "~" will appear on a device. If a line is indented then it is a continuation of the previous line and the two combined represent the entire Device Marking for that device.

(6) Lead finish/Ball material - Orderable Devices may have multiple material finish options. Finish options are separated by a vertical ruled line. Lead finish/Ball material values may wrap to two lines if the finish value exceeds the maximum column width.

Important Information and Disclaimer: The information provided on this page represents TI's knowledge and belief as of the date that it is provided. TI bases its knowledge and belief on information provided by third parties, and makes no representation or warranty as to the accuracy of such information. Efforts are underway to better integrate information from third parties. TI has taken and continues to take reasonable steps to provide representative and accurate information but may not have conducted destructive testing or chemical analysis on incoming materials and chemicals. TI and TI suppliers consider certain information to be proprietary, and thus CAS numbers and other limited information may not be available for release.

In no event shall TI's liability arising out of such information exceed the total purchase price of the TI part(s) at issue in this document sold by TI to Customer on an annual basis.

IMPORTANT NOTICE AND DISCLAIMER

TI PROVIDES TECHNICAL AND RELIABILITY DATA (INCLUDING DATA SHEETS), DESIGN RESOURCES (INCLUDING REFERENCE DESIGNS), APPLICATION OR OTHER DESIGN ADVICE, WEB TOOLS, SAFETY INFORMATION, AND OTHER RESOURCES "AS IS" AND WITH ALL FAULTS, AND DISCLAIMS ALL WARRANTIES, EXPRESS AND IMPLIED, INCLUDING WITHOUT LIMITATION ANY IMPLIED WARRANTIES OF MERCHANTABILITY, FITNESS FOR A PARTICULAR PURPOSE OR NON-INFRINGEMENT OF THIRD PARTY INTELLECTUAL PROPERTY RIGHTS.

These resources are intended for skilled developers designing with TI products. You are solely responsible for (1) selecting the appropriate TI products for your application, (2) designing, validating and testing your application, and (3) ensuring your application meets applicable standards, and any other safety, security, regulatory or other requirements.

These resources are subject to change without notice. TI grants you permission to use these resources only for development of an application that uses the TI products described in the resource. Other reproduction and display of these resources is prohibited. No license is granted to any other TI intellectual property right or to any third party intellectual property right. TI disclaims responsibility for, and you will fully indemnify TI and its representatives against, any claims, damages, costs, losses, and liabilities arising out of your use of these resources.

TI's products are provided subject to [TI's Terms of Sale](#) or other applicable terms available either on [ti.com](https://www.ti.com) or provided in conjunction with such TI products. TI's provision of these resources does not expand or otherwise alter TI's applicable warranties or warranty disclaimers for TI products.

TI objects to and rejects any additional or different terms you may have proposed.

Mailing Address: Texas Instruments, Post Office Box 655303, Dallas, Texas 75265
Copyright © 2023, Texas Instruments Incorporated

X-ON Electronics

Largest Supplier of Electrical and Electronic Components

Click to view similar products for [Power Management Modules](#) category:

Click to view products by [Texas Instruments](#) manufacturer:

Other Similar products are found below :

[IA0505KS-2W](#) [IA1205KS-2W](#) [RKF60-48S12](#) [RMF100-48S12W](#) [RMF100-48S24W](#) [RMF150-24S12](#) [RMF150-24S24](#) [RMF150-48S12](#)
[RLM300-110S24TM](#) [RLM150-110S48](#) [RCE300-24S24](#) [RD5-12S24W](#) [RD5-110S05W](#) [RD5-110S12W](#) [RKD50-24S24](#) [RM100-110S05W](#)
[RM150-110S12W](#) [RM150-110S24W](#) [MAS15-24-W](#) [RKAS50-5-N](#) [RKAS100-12-N](#) [RKAS100-24-N](#) [KAS75-12-W](#) [KAS75-24-W](#) [RAS25-5-](#)
[W](#) [RAS25-12-W](#) [RAS25-24-W](#) [TAS5-15-WEDT](#) [ZY2424FLS-1W](#) [ZY0505AS-1W](#) [A1209S-2W](#) [G2412S-1W](#) [E0509S-1W](#) [G0505S-1W](#)
[E0509S-2W](#) [G2415S-2W](#) [G2412S-2W](#) [E1212S-2W](#) [A0512S-1W](#) [A1212S-2W](#) [URB4824S-6WR3](#) [G2405S-1W](#) [E0505S-2W](#) [E2412S-2W](#)
[URB4805S-6WR3](#) [E2415S-2W](#) [TDK6-24S24W](#) [GH10-V2S15](#) [GH60-V2S24-L](#) [GH25-V2S24-L](#)