



Features

- Efficient, low-cost solution for driving MOSFETs and IGBTs
- Wide supply voltage operating range: 4.5V to 18V
- 1.9A source / 1.8A sink output current capability
- Inverting and non-inverting input configurations
- Fast propagation delays (35ns typical)
- Fast rise and fall times (15ns typical)
- Logic input (IN) 3.3V capability
- Offered in two different pinout options
- Space saving SOT23-5L package
- Extended temperature range: -40°C to +125°C

Applications

- Switch mode power supplies
- Motor Drive
- Line Drivers
- DC-DC Converters



Description

The TF0215(S)/16(S) high speed, low side MOSFET and IGBT drivers are capable of driving 1.9A of peak current. The TF0215(S)/16(S) logic inputs are compatible with standard TTL and CMOS levels (down to 3.3V) to interface easily with MCUs. Fast and well matched propagation delays allow high speed operation, enabling a smaller, more compact power switching design using smaller associated components.

These devices are highly resistant to noise by being able to withstand up to 5V positive or negative on the input pin without damage. Also they can accept 500mA of reverse current forced back into its outputs without damage or logic change. The TF0215(S) provides an inverted output and the TF0216(S) provides a noninverting output. The TF0215 and TF0216 provide a different pinout to the TF0215S and TF0216S. The TF0215(S)/16(S) comes in a space-saving SOT23-5L package and it operates over an extended -40 °C to +125 °C temperature range.

Ordering Information

Year Year Week Week

PART NUMBER	PACKAGE	PACK / Qty	MARK
TF0215-USQ	SOT23-5L	T&R / 3,000	YYWW TF0215/16
TF0216-USQ	SOT23-5L	T&R / 3,000	
TF0215S-USQ	SOT23-5L	T&R / 3,000	YYWW TF0215S/16S
TF0216S-USQ	SOT23-5L	T&R / 3,000	

Typical Application

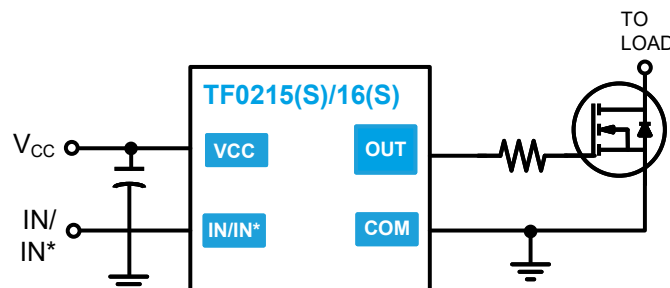

Pin Diagrams

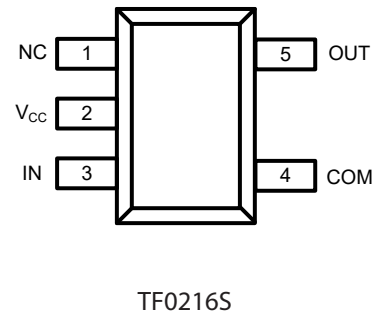
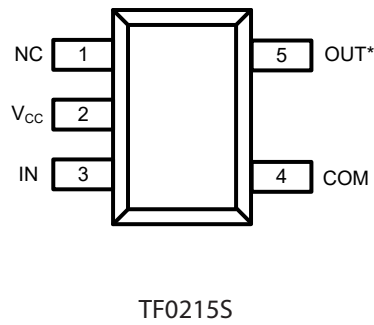
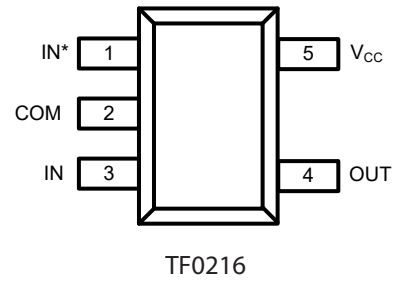
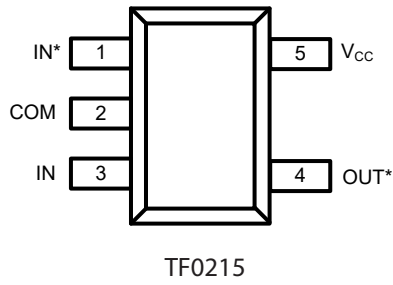

Top View: SOT23-5L

Pin Descriptions

PIN NAME	PIN DESCRIPTION
IN*	Logic input, in phase with OUT* (TF0215), out of phase with OUT (TF0216), leave open when not in use.
COM	Supply return
IN	Logic input, out of phase with OUT* (TF0215(S)), in phase with OUT (TF0216(S)), leave open when not in use.
OUT	Gate drive output
OUT*	Gate drive output, inverted
V _{CC}	Supply input
NC	No connect

Functional Block Diagram

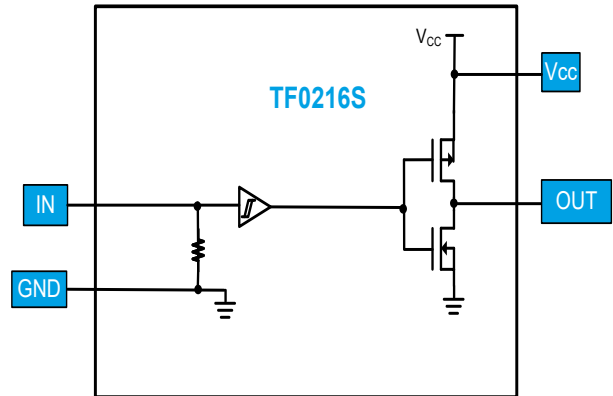
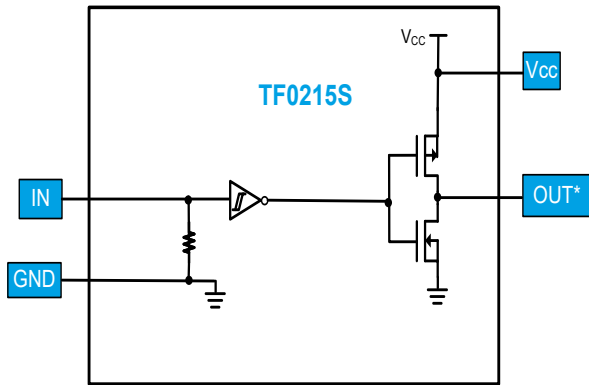
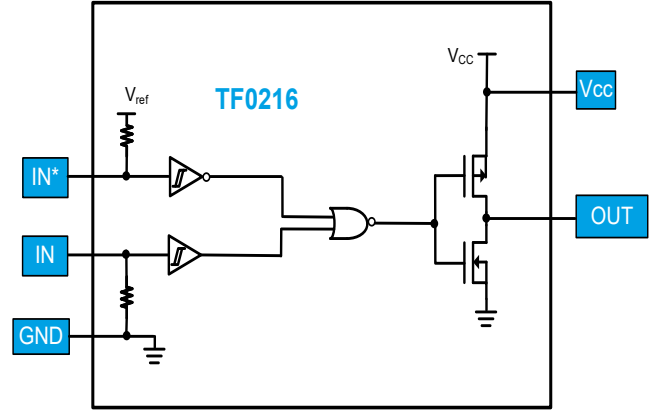
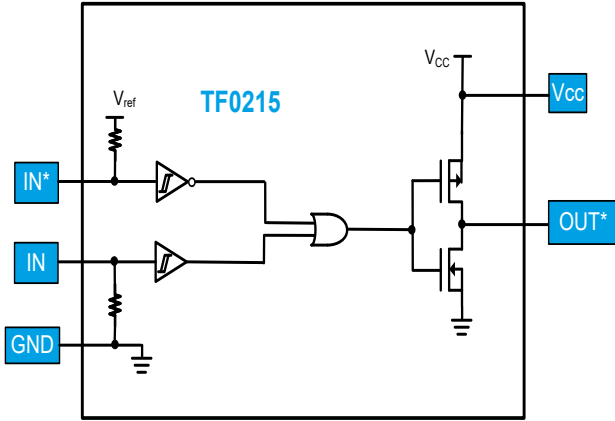

Absolute Maximum Ratings (NOTE1)

V_{CC} - Low-side fixed supply voltage.....-0.3V to +22V
 V_{OUT} - Output voltage (OUT/OUT*).....-0.3V to V_{CC} +0.3V
 V_{IN} - Logic input voltage (IN/IN*).....-5V to V_{CC} +0.3V
 ESD Protection on all pins.....2kV (HBM)
 400V (MM)

P_D - Package power dissipation at $T_A \leq 25^\circ\text{C}$
 SOT23-5L.....0.54W
 SOT23-5L Thermal Resistance **(NOTE2)**
 θ_{JA}188 $^\circ\text{C/W}$
 T_J - Junction operating temperature.....+150 $^\circ\text{C}$
 T_L - Lead Temperature (soldering, 10 seconds).....+300 $^\circ\text{C}$
 T_{stg} - Storage temperature-55 to 150 $^\circ\text{C}$

NOTE1 Stresses beyond those listed under "Absolute Maximum Ratings" may cause permanent damage to the device. These are stress ratings only, and functional operation of the device at these or any other conditions beyond those indicated in the operational sections of the specifications is not implied. Exposure to absolute maximum rating conditions for extended periods may affect device reliability.

NOTE2 When mounted on a standard JEDEC 2-layer FR-4 board.

Recommended Operating Conditions

Symbol	Parameter	MIN	MAX	Unit
V_{CC}	Supply voltage	4.5	18	V
V_{OUT}	Output voltage (OUT/OUT*)	0	V_{CC}	V
V_{IN}	Logic input voltage (IN/IN*)	0	5	V
T_A	Ambient temperature	-40	125	$^\circ\text{C}$

Electrical Characteristics (NOTE3)

 V_{BIAS} (4.5V < V_{CC} < 18V), $T_A = 25\text{ }^\circ\text{C}$, unless otherwise specified.

Symbol	Parameter	Conditions	MIN	TYP	MAX	Unit
DC Characteristics						
V_{IH}	Logic "1" input voltage		2.4	1.6		V
V_{IL}	Logic "0" input voltage			1.3	0.8	
I_{IN+}	Logic "1" input bias current	$V_{IN} = 3V, V_{IN*} = 0V$			5	μA
I_{IN-}	Logic "0" input bias current	$V_{IN} = 0V, V_{IN*} = 3V$			2	
V_{OH}	High level output voltage, $V_{BIAS} - V_O$			25		mV
V_{OL}	Low level output voltage			25		
I_{CCQ}	V_{CC} quiescent supply current	$V_{IN} = 0V$ or $3V$		50	100	μA
I_{O+}	Output high short circuit pulsed current	$V_{CC} = 12V$		1.9		A
I_{O-}	Output low short circuit pulsed current	$V_{CC} = 12V$		1.8		
R_{OH}	Output Resistance, High	$I_{OUT} = 10\text{mA}, V_{CC} = 12V$		3.3		Ω
R_{OL}	Output Resistance, Low	$I_{OUT} = 10\text{mA}, V_{CC} = 12V$		2.3		Ω
Switching Characteristics						
t_r	Turn-on rise time	$C_L = 1000\text{pF}, V_{CC} = 12V$		15	25	ns
t_f	Turn-off fall time	$C_L = 1000\text{pF}, V_{CC} = 12V$		15	25	ns
t_{on}	Turn-on propagation delay	$V_{CC} = 12V$		35	50	ns
t_{off}	Turn-off propagation delay	$V_{CC} = 12V$		35	55	ns

NOTE3 The V_{IN} and I_{IN} parameters are applicable to the logic input pin: IN and IN*. The V_O and I_O parameters are applicable to the output pins: OUT and OUT*

Timing Waveforms

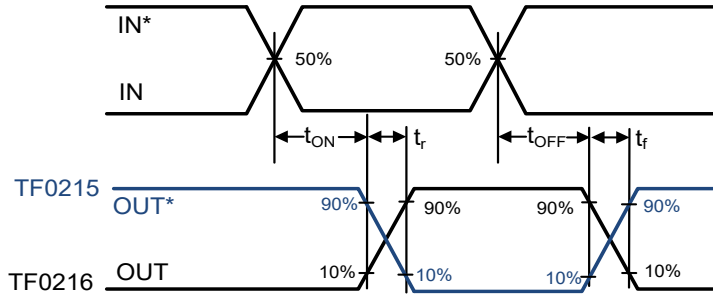

Figure 1. Switching Time Waveform Definitions

Input/Output response table

IN	IN*	TF0215 (OUT*)	TF0216 (OUT)
H	H (open)	L	H
L	H (open)	H	L
L (open)	H	H	L
L (open)	L	L	H

IN	TF0215S (OUT*)	TF0216S (OUT)
H	L	H
L	H	L
L (open)	H	L

Typical performance graphs

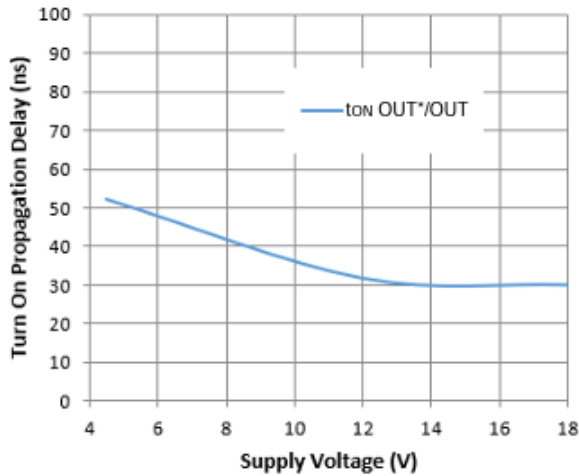

Figure 2. Turn-on Propagation Delay vs. Supply Voltage

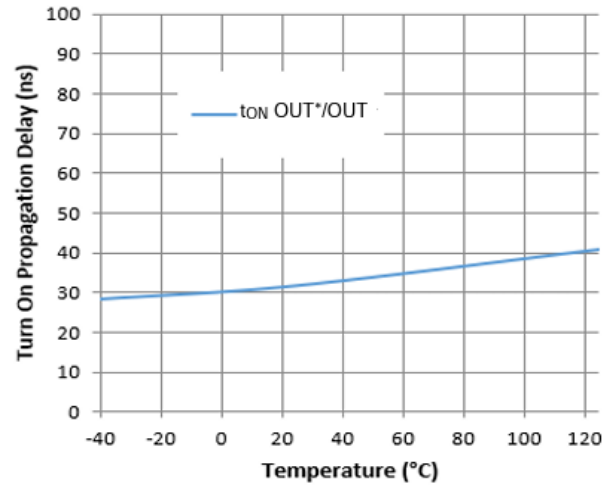

Figure 3. Turn-on Propagation Delay vs. Temperature

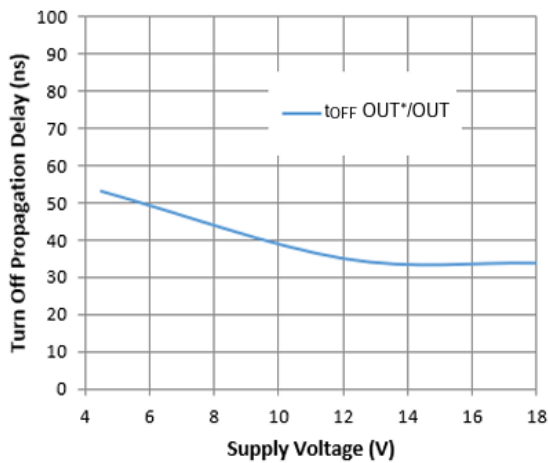

Figure 4. Turn-off Propagation Delay vs. Supply Voltage

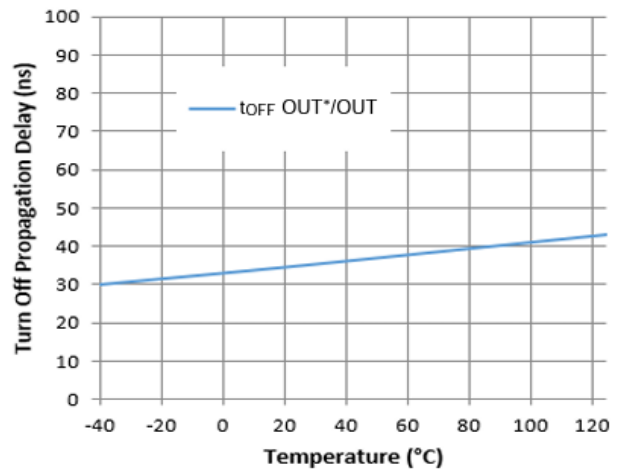

Figure 5. Turn-off Propagation Delay vs. Temperature

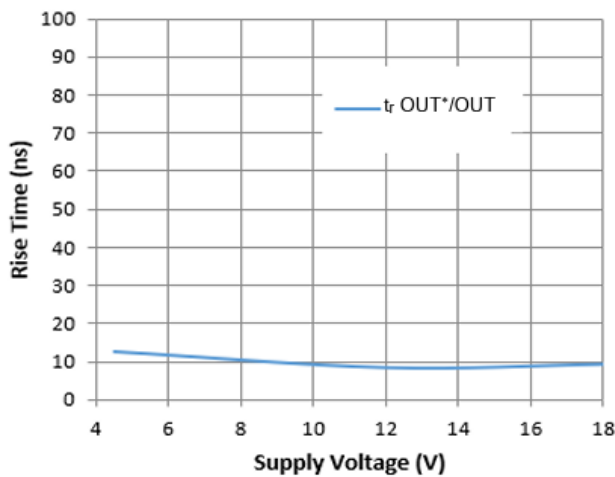

Figure 6. Rise Time vs. Supply Voltage

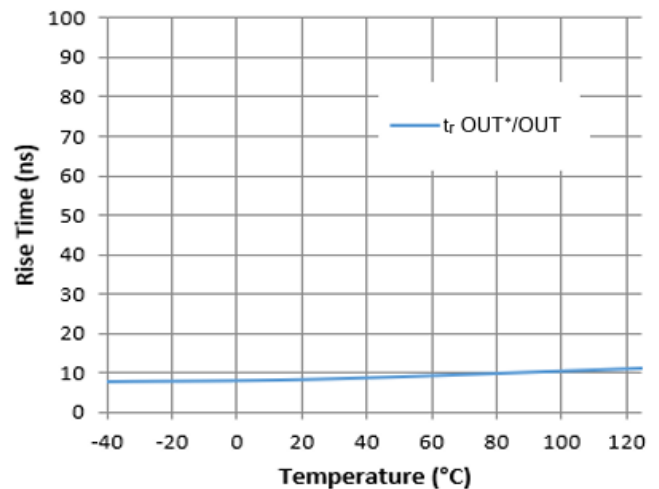

Figure 7. Rise Time vs. Temperature

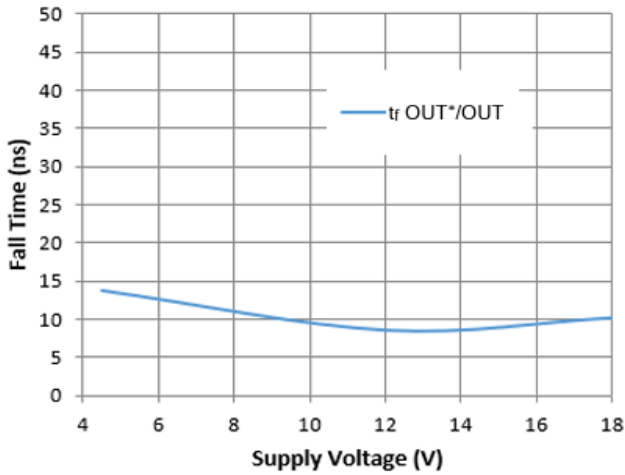

Figure 8. Fall Time vs. Supply Voltage

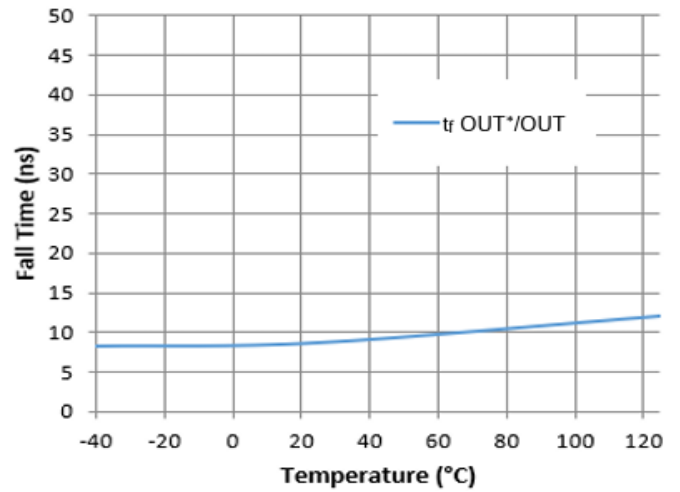

Figure 9. Fall Time vs. Temperature

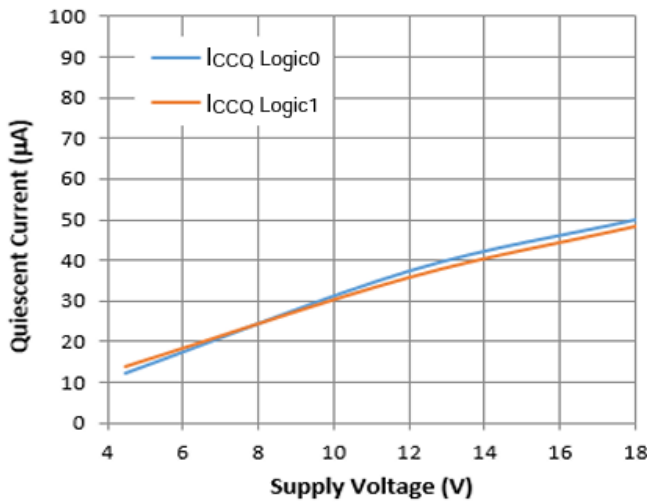

Figure 10. Quiescent Current vs. Supply Voltage

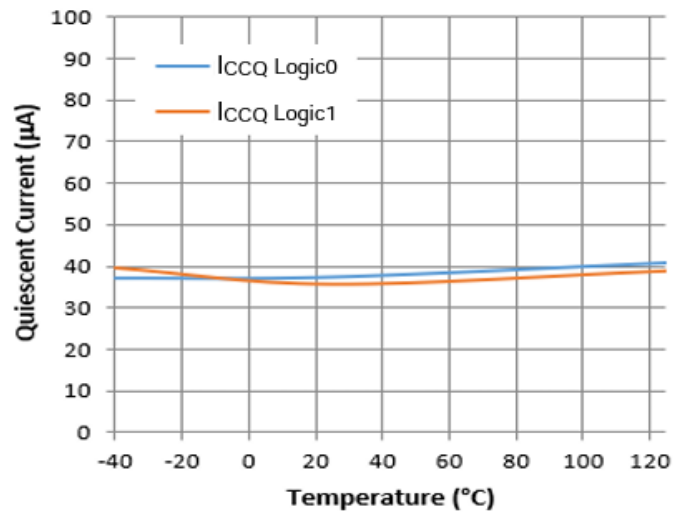

Figure 11. Quiescent Current vs. Temperature

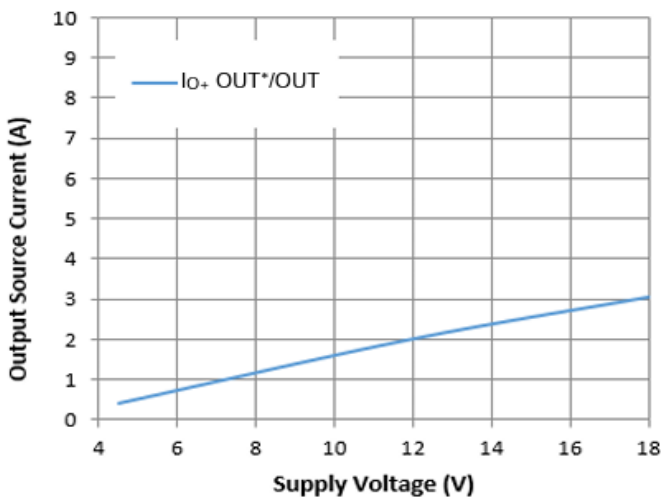

Figure 12. Output Source Current vs. Supply Voltage

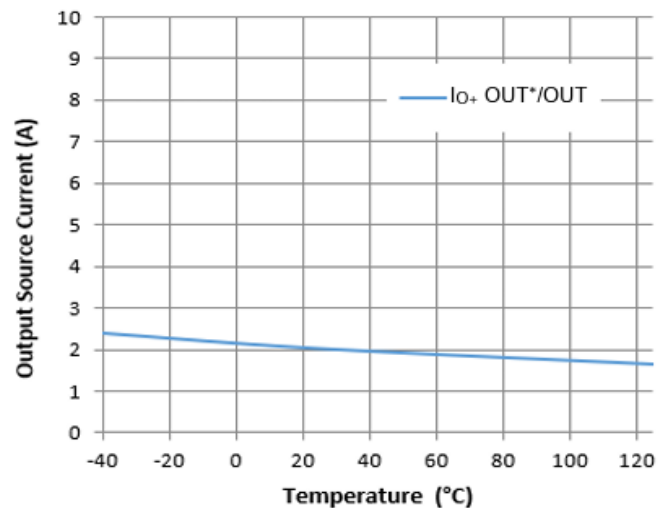

Figure 13. Output Source Current vs. Temperature

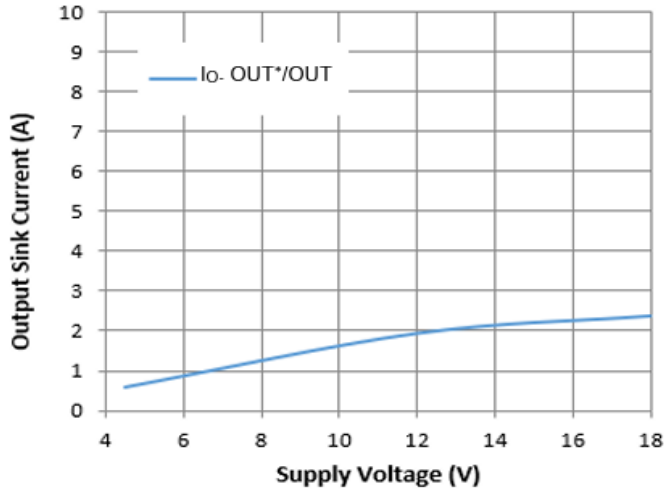

Figure 14. Output Sink Current vs. Supply Voltage

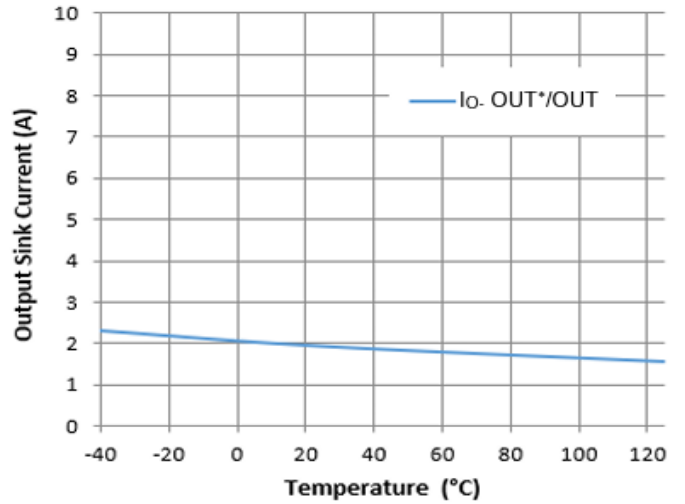

Figure 15. Output Sink Current vs. Temperature

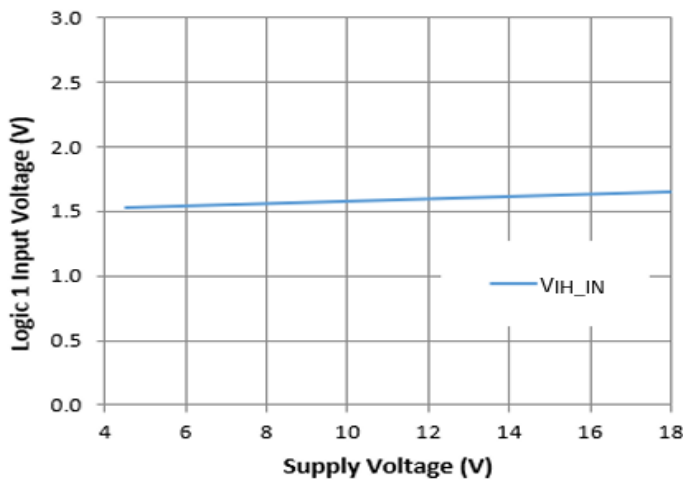

Figure 16. Logic 1 Input Voltage vs. Supply Voltage

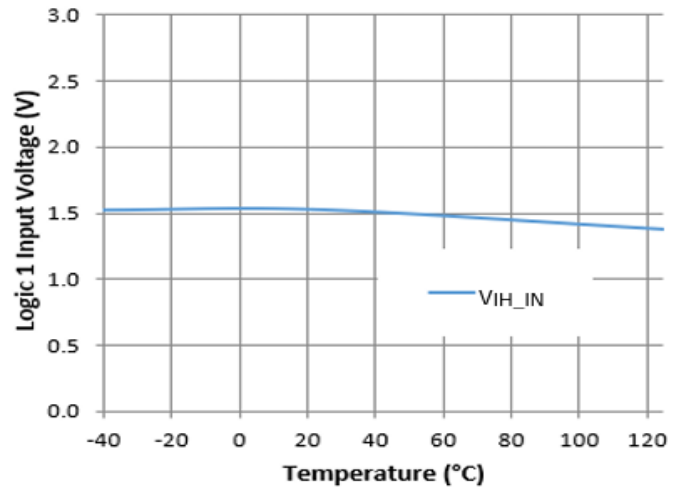

Figure 17. Logic 1 Input Voltage vs. Temperature

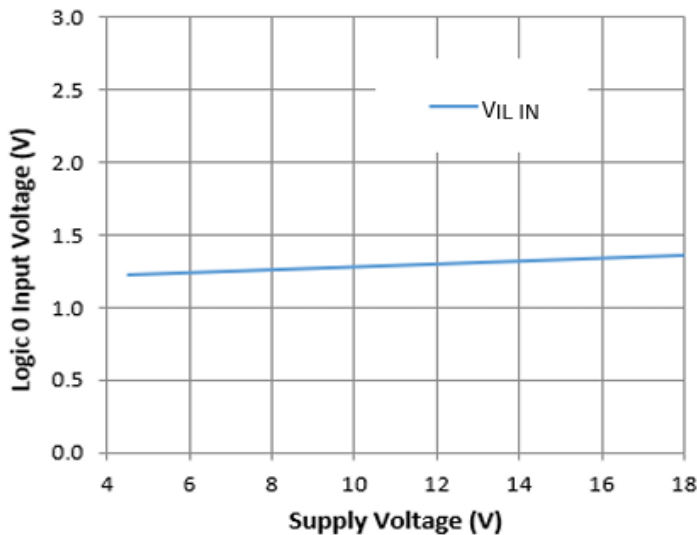

Figure 18. Logic 0 Input Voltage vs. Supply Voltage

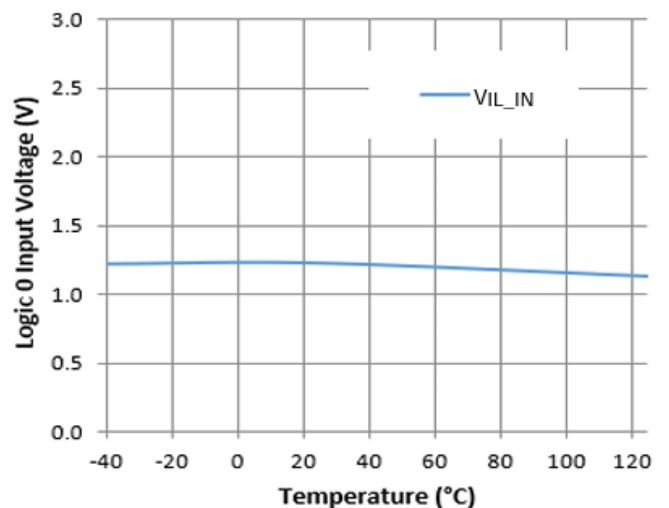
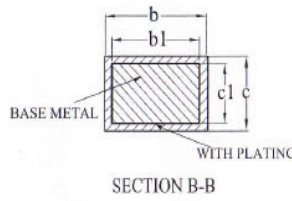
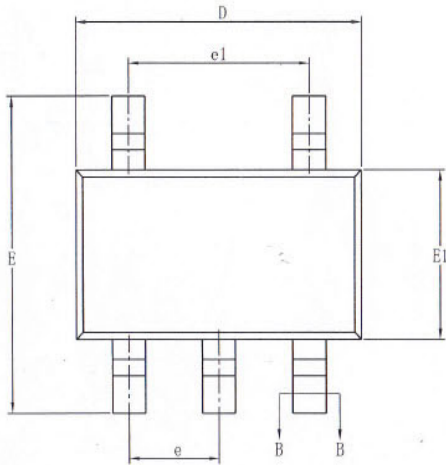
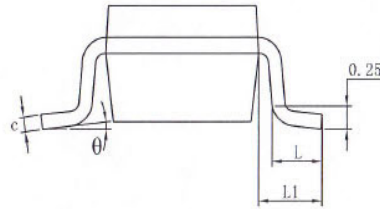
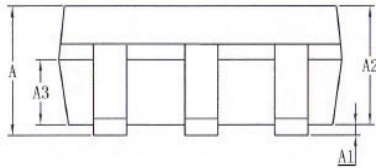

Figure 19. Logic 0 Input Voltage vs. Temperature

Package Dimensions (SOT23-5L)

Please contact support@tfsemi.com for package availability.



SYMBOL	MILLIMETER		
	MIN	NOM	MAX
A	—	—	1.25
A1	0.04	—	0.10
A2	1.00	1.10	1.20
A3	0.60	0.65	0.70
b	0.33	—	0.41
b1	0.32	0.35	0.38
c	0.15	—	0.19
c1	0.14	0.15	0.16
D	2.82	2.92	3.02
E	2.60	2.80	3.00
E1	1.50	1.60	1.70
e	0.95BSC		
e1	1.90BSC		
L	0.30	—	0.60
L1	0.60REF		
θ	0	—	8°

Revision History

Rev.	Change	Owner	Date
1.0	First release, final datasheet	Keith Spaulding	4/16/2021
2.0	Change of revision numbering only	Keith Spaulding	4/7/2023
2.1	Change package drawing	Keith Spaulding	6/10/2023
2.2	Add TF0215S/TF0216S pinout option to ds	Keith Spaulding	6/19/2023
2.3	Remove Electrical specifications table with over temperature conditions, Added Ordering information table on pg. 1, Added Typical performance graphs	Keith Spaulding	6/29/2023

Important Notice

TF Semiconductor Solutions (TFSS) PRODUCTS ARE NEITHER DESIGNED NOR INTENDED FOR USE IN MILITARY AND/OR AEROSPACE, AUTOMOTIVE OR MEDICAL DEVICES OR SYSTEMS UNLESS THE SPECIFIC TFSS PRODUCTS ARE SPECIFICALLY DESIGNATED BY TFSS FOR SUCH USE. BUYERS ACKNOWLEDGE AND AGREE THAT ANY SUCH USE OF TFSS PRODUCTS WHICH TFSS HAS NOT DESIGNATED FOR USE IN MILITARY AND/OR AEROSPACE, AUTOMOTIVE OR MEDICAL DEVICES OR SYSTEMS IS SOLELY AT THE BUYER'S RISK.

TFSS assumes no liability for application assistance or customer product design. Customers are responsible for their products and applications using TFSS products.

Resale of TFSS products or services with statements different from or beyond the parameters stated by TFSS for that product or service voids all express and any implied warranties for the associated TFSS product or service. TFSS is not responsible or liable for any such statements.

©2021 TFSS. All Rights Reserved. Information and data in this document are owned by TFSS wholly and may not be edited, reproduced, or redistributed in any way without the express written consent from TFSS.

For additional information please contact support@tfsemi.com or visit www.tfsemi.com.

X-ON Electronics

Largest Supplier of Electrical and Electronic Components

Click to view similar products for [Gate Drivers](#) category:

Click to view products by [TFSS](#) manufacturer:

Other Similar products are found below :

[56956](#) [57.404.7355.5](#) [LT4936](#) [57.904.0755.0](#) [5811-0902](#) [0131700000](#) [LTP70N06](#) [LVP640](#) [5J0-1000LG-SIL](#) [LY2-US-AC240](#) [LY3-UA-DC24](#) [LZNQ2-US-DC12](#) [LZP40N10](#) [60100564](#) [60249-1-CUT-TAPE](#) [0134220000](#) [6035](#) [60713816](#) [61161-90](#) [6131-204-23149P](#) [6131-205-17149P](#) [6131-209-15149P](#) [6131-218-17149P](#) [6131-220-21149P](#) [6131-260-2358P](#) [6131-265-11149P](#) [CS1HCPU63](#) [6150-5001](#) [CSB4](#) [CSK-38-60006](#) [CSK-38-60008](#) [621A](#) [622-4053LF](#) [6273](#) [M40N08MA-H](#) [M55155/29XH06](#) [64-807](#) [65-1930-6](#) [CV500ISB02](#) [M83723/88Y1407N](#) [CWD012-2](#) [CWD03-3](#) [CX3225SB16934D0PPSC2](#) [CX5032GB10000D0PPS02](#) [687-772NF1](#) [70.140.1653](#) [70.200.0653.0](#) [703001B01F060](#) [70-3601](#) [706006D02F0601](#)