

Product Specification

深圳市臺華達科技有限公司

SHENZHENSHI THD Electronics Co., Ltd.

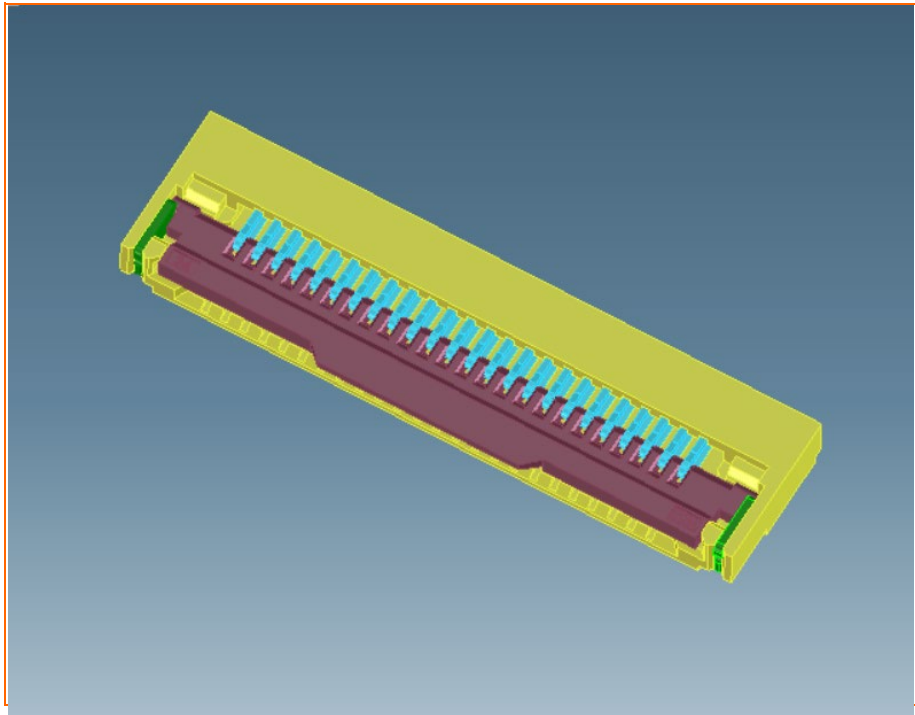

Product.No

THD0513 – xxCL – GF

Pitch=0.50mm,H=1.35 mm FPC Connector (Front-Flip Lower Contact)

A	Release
Rev.	Description

Approved Signatures

■Prepared By : Kavın	■Date: 2019.01.21
■Checked By : JIM	■Date: 2019.01.21
■Approved By : 黃德進	■Date: 2019.01.21

■ Scope

This specification covers the 0.5 mm Pitch FPC Connector **THD0513** series.

■ Ordering information

THD0513 - xx CL - GF

① ② ③ ④

①	Series name : THD0513	④	Plating : GF= 1μ"~3μ" Gold Flash G3= 3μ" Gold over Nickel G5= 5μ" Gold over Nickel SN= Tin(Lead Free) over Nickel
②	Number of contacts : 4 TO 60		
③	Contact type : CL:Lower contact		

■ Rating

Item	Standard
Voltage Rating(Max.)	50V AC
Current Rating(Max.)	0.5A DC
Operating Temperature Range	-25°C ~ +85°C (Including terminal temperature rise)

■ Material

Housing	Actuator	Terminal	Plating	Solder pin	Plating
L.C.P (UL94V-0)	L.C.P (UL94V-0)	Copper alloy	AU over Nickel	Copper alloy	TIN over
Color : Beige	Color : Black				Nickel

■ Performance

Item	Test Condition	Specification	
Contact Resistance	Mate applicable FPC and measure by dry circuit, 20mV Max, 1mA.	30 mΩ Max.	
Insulation Resistance	Mate applicable FPC and apply 500V DC between adjacent terminal or ground.	500 MΩ Min.	
Dielectric Strength	Mate applicable FPC, apply 250V AC(rms) for 1 minute between adjacent terminal or ground.	No Breakdown	
FPC Retention Force	Insert the actuator, pull the FPC at a rate of 25±3mm per minute.	Per pin x 0.3N Min.	
Terminal Retention Force	Apply axial pull out force at the rate of 25±3mm/minute on the terminal assembled in the housing.	Per pin x 0.05Kgf {0.5N} Min.	
Vibration	Mate connectors and subject to the following vibration conditions, for period of 2 hours in each of 3 mutually perpendicular axes, passing DC 1mA during the test. Amplitude : 1.5mm P-P Frequency : 10~55~10 Hz in 1 minute. Duration : 2 hours in each of X,Y,Z axes.	Appearance	No Damage
		Contact Resistance	50 mΩ Max.
		Discontinuity	1 μsec Max.
Shock	Mate applicable FPC and subject to the following shock conditions. 3 times of shocks shall be applied for each 6 directions along 3 mutually perpendicular axes, passing DC 1 mA current during the test. Peak value : 490m/s ² {50G}	Appearance	No Damage
		Contact Resistance	50 mΩ Max.
		Discontinuity	1 μsec Max.
Salt Spray	Mate applicable FPC and expose to the following salt mist conditions. Upon completion of the exposure period, salt deposits shall be removed by a gentle wash or dip in running water, after which the specified measurements shall be performed. NaCl solution Concentration : 5 ± 1% Spray time : 48 ± 4 hours Ambient temperature : 35 ± 2°C	Appearance	No Damage
		Contact Resistance	50 mΩ Max.

Item	Test Condition	Specification	
Heat Resistance	Mate applicable FPC and expose to 85±2°C for 96 hours. Upon completion of the exposure period, the test specimens shall be conditioned at ambient room conditions for 1 to 2 hours, after which the specified measurements shall be performed.	Appearance	No Damage
		Contact Resistance	50 mΩ Max.
Cold Resistance	Mate applicable FPC and expose to -40±2°C for 96 hours. Upon completion of the exposure period, the test specimens shall be conditioned at ambient room conditions for 1 to 2 hours, after which the specified measurements shall be performed.	Appearance	No Damage
		Contact Resistance	50 mΩ Max.
Humidity	Mate applicable FPC and expose to 60 ± 2°C, relative humidity 90 to 95% for 96 hours. Upon completion of the exposure period, the test specimens shall be conditioned at ambient room conditions for 1 to 2 hours, after which the specified measurements shall be performed.	Appearance	No Damage
		Contact Resistance	50 mΩ Max.
		Dielectric Strength	No Breakdown
		Insulation Resistance	100 MΩ Min.
Temperature Rise	Mate applicable FPC and measure the temperature rise of contact when the maximum AC rated current is passed.	Temperature rise	30°C Max.
Temperature Cycling	Mate applicable FPC and subject to the following conditions for 5 cycles. Upon completion of the exposure period, the test specimens shall be conditioned at ambient room conditions for 1 to 2 hours, after which the specified measurements shall be performed. 1 cycle a) -55±3°C 30minutes b) +85±3°C 30minutes (Transit time shall be with in 3 minutes)	Appearance	No Damage
		Contact Resistance	50 mΩ Max.
Solderability	Tip of solder tails and fitting nails into the molten solder (held at 245±5°C) up to 0.1mm from the bottom of the housing for 3±0.5 seconds.	Solder Wetting	95% of immersed area must show no voids, pin holes.
Resistance to Soldering	When reflowing refer to Infrared reflow condition <u>Soldering iron method</u> 0.2mm from terminal tip and fitting nail tip. Soldering time : 5 seconds Max. Solder temperature : 370~400°C	Appearance	No Damage

■ Recommended Temperature Profile

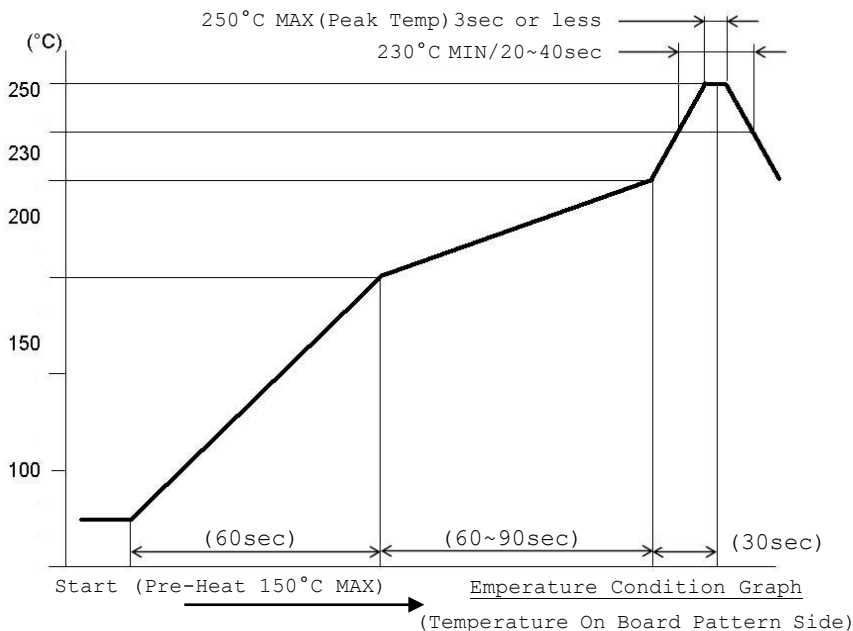

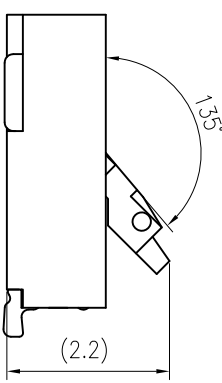
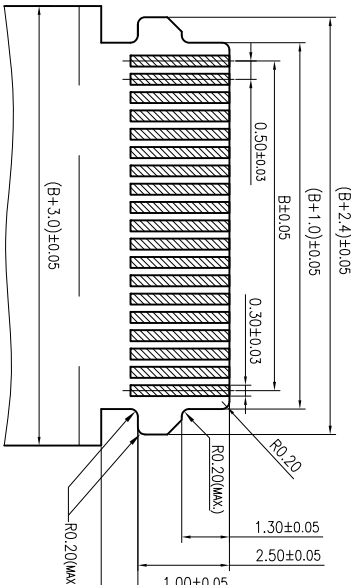
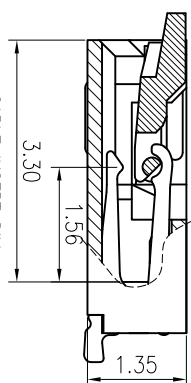
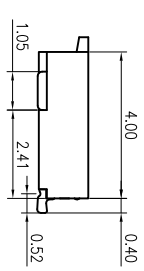
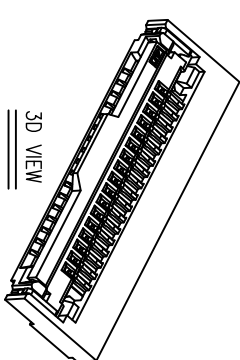
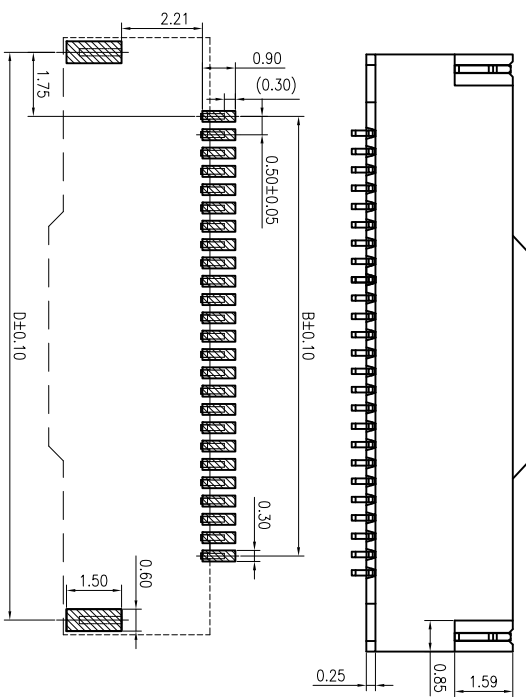
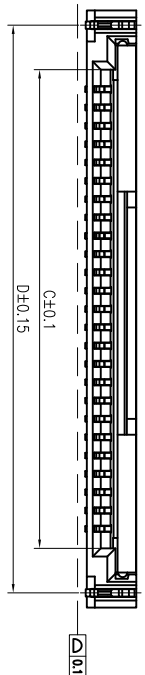
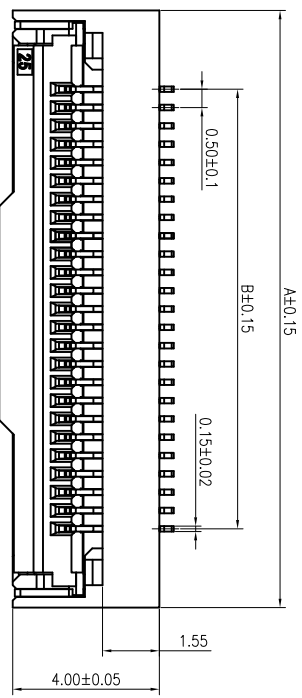

NOTES:

- 1.HOUSING: LCP HIGH-TEMP THERMOPLASTIC UL94V-0 COLOR:BEIGE
- 2.ACTUATOR: LCP HIGH-TEMP THERMOPLASTIC UL94V-0 COLOR:BLACK
- 3.TERMINAL:PHOSPHOR BRONZE
PLATING:1*“GOLD FLASH OR 100~150*“TIN(LEAD FREE)
OVERALL 50~100*“NICKEL UNDER PLATED.
- 4.FITTING NAIL:BRASS
PLATING:100~150*“TIN(LEAD FREE)
OVERALL 50~100*“NICKEL UNDER PLATED.
- 5.CODING INFORMATION: THD0513-xxCL-GF

NO. OF CONTACTS
0.5PITCH 1.35H FPC SMT CONN.
TAHUADA FPC CONNECTOR SERIES

No. of contacts	Dimensions				No. of contacts	Dimensions			
	A	B	C	D		A	B	C	D
4	5.80	1.50	2.57	5.00	33	20.30	16.00	17.07	19.50
5	6.30	2.00	3.07	5.50	34	20.80	16.50	17.57	20.00
6	6.80	2.50	3.57	6.00	35	21.30	17.00	18.07	20.50
7	7.30	3.00	4.07	6.50	36	21.80	17.50	18.57	21.00
8	7.80	3.50	4.57	7.00	37	22.30	18.00	19.07	21.50
9	8.30	4.00	5.07	7.50	38	22.80	18.50	19.57	22.00
10	8.80	4.50	5.57	8.00	39	23.30	19.00	20.07	22.50
11	9.30	5.00	6.07	8.50	40	23.80	19.50	20.57	23.00
12	9.80	5.50	6.57	9.00	41	24.30	20.00	21.07	23.50
13	10.30	6.00	7.07	9.50	42	24.80	20.50	21.57	24.00
14	10.80	6.50	7.57	10.00	43	25.30	21.00	22.07	24.50
15	11.30	7.00	8.07	10.50	44	25.80	21.50	22.57	25.00
16	11.80	7.50	8.57	11.00	45	26.30	22.00	23.07	25.50
17	12.30	8.00	9.07	11.50	46	26.80	22.50	23.57	26.00
18	12.80	8.50	9.57	12.00	47	27.30	23.00	24.07	26.50
19	13.30	9.00	10.07	12.50	48	27.80	23.50	24.57	27.00
20	13.80	9.50	10.57	13.00	49	28.30	24.00	25.07	27.50
21	14.30	10.00	11.07	13.50	50	28.80	24.50	25.57	28.00
22	14.80	10.50	11.57	14.00	51	29.30	25.00	26.07	28.50
23	15.30	11.00	12.07	14.50	52	29.80	25.50	26.57	29.00
24	15.80	11.50	12.57	15.00	53	30.30	26.00	27.07	29.50
25	16.30	12.00	13.07	15.50	54	30.80	26.50	27.57	30.00
26	16.80	12.50	13.57	16.00	55	31.30	27.00	28.07	30.50
27	17.30	13.00	14.07	16.50	56	31.80	27.50	28.57	31.00
28	17.80	13.50	14.57	17.00	57	32.30	28.00	29.07	31.50
29	18.30	14.00	15.07	17.50	58	32.80	28.50	29.57	32.00
30	18.80	14.50	15.57	18.00	59	33.30	29.00	30.07	32.50
31	19.30	15.00	16.07	18.50	60	33.80	29.50	30.57	33.00
32	19.80	15.50	16.57	19.00	61	34.30	30.00	31.07	33.50

CABLE INSERT DIM.
SCALE 2:1

COVER OPEN STATE

RECOMMENDED PCB PATTERN DIM.
TOLERANCE : ±0.05

APPLICABLE FPC/FPC
(THICKNESS 0.3±0.03)

REV.	REVISIONS	CHK	DATE

CUSTOMER
SHENZHENSHI THD TECHNOLOGY CO., LTD.

DRW: Kavin
2019.01.10
PART NO. THD0513-xxCL-GF

GENERAL TOLERANCE UNLESS OTHERWISE SPECIFIED
OTHERWISE SPECIFIED

APPROVED: 黄德进
2019.01.10

CHECKED: 胡文
2019.01.10

TITLE: 0.5PITCH 1.35H FPC SMT CONN.

SCALE: 1:1
SIZE: A4
REV: X1

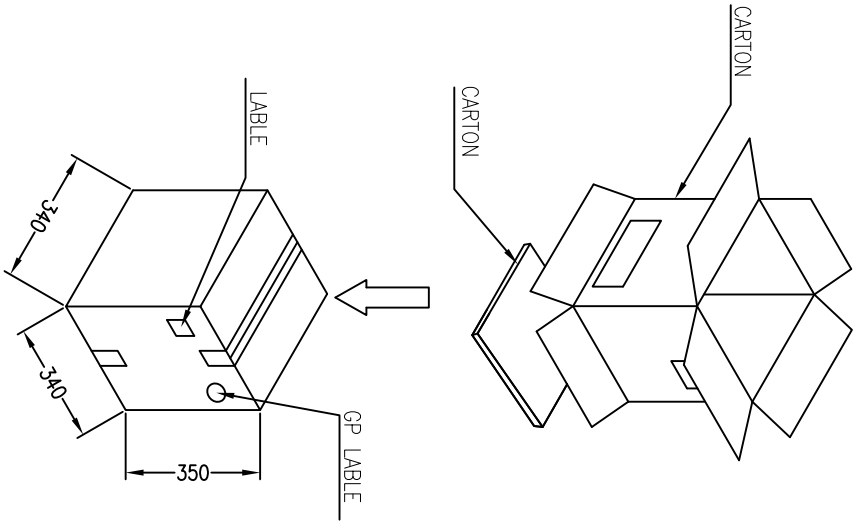
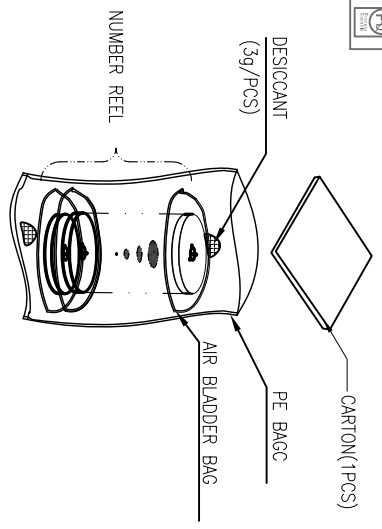

Tape width 16 and 24 mm

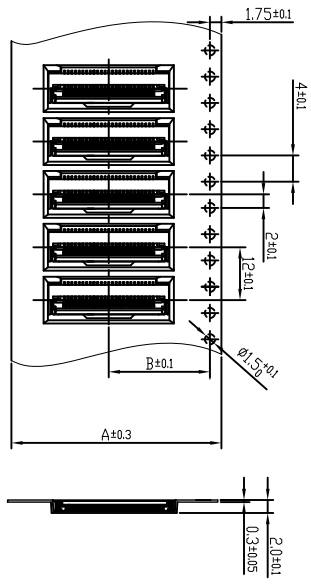

Tape width 32 and 56 mm

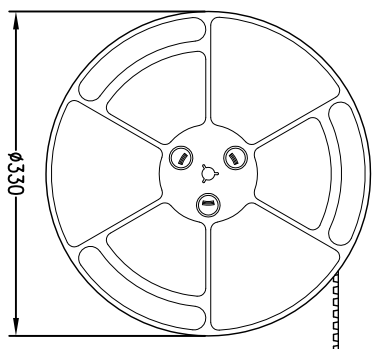
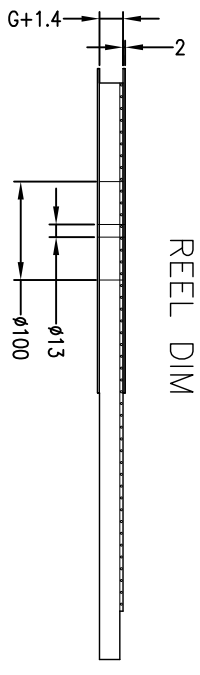
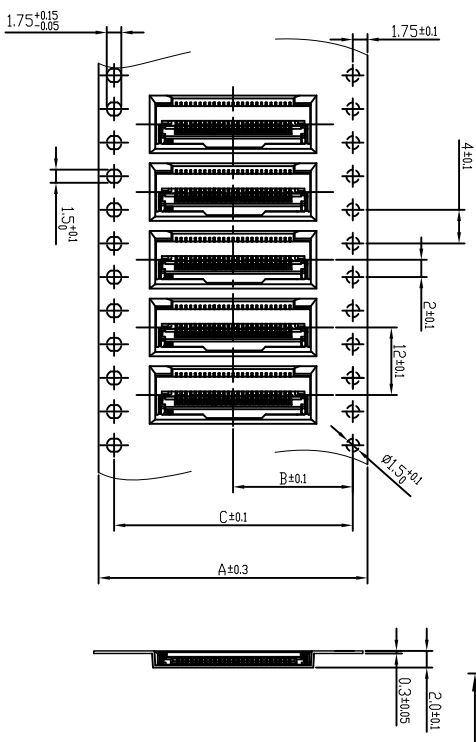

- NOTES:
1. Component load per 13" reel: 4000 pcs
 2. Material: black conductive polystyrene alloy.
 3. Thickness: 0.3±0.05mm
 4. All dimensions meet EIA-481-C requirements

No. of Contacts	A	B	C	REEL (CARTON)	SUM(PCS)
THD0513 4pin~8pin	16	7.5	—	15	60000
THD0513 9pin~24pin	24	11.5	—	10	40000
THD0513 25pin~33pin	32	14.2	28.4	8	32000
THD0513 34pin~54pin	44	20.2	40.4	6	24000
THD0513 55pin~60pin	56	26.25	52.5	5	20000

REV.	REVISIONS	CHK	DATE

CUSTOMER

SHENZHENSHI THD ELECTRONICS CO., LTD.

深圳市臺華達科技有限公司

SHENZHENSHI THD ELECTRONICS CO., LTD.

DRAWN: Kavin
CHECKED: 胡文
DATE: 2019.01.10

PART NO. THD0513-xxCL-xx

TITLE: 0.5 PITCH 1.3H FPC CONN.

APPROVED: 黃德達
DATE: 2019.01.10

SHEET: 1/1

UNIT: mm

SCALE: 1:1

SIZE: A4

REV: X2

GENERAL TOLERANCE UNLESS OTHERWISE SPECIFIED

XX ±0.25
XXX ±0.20
XXXX ±0.10
ANG. ±3

X-ON Electronics

Largest Supplier of Electrical and Electronic Components

Click to view similar products for [FFC & FPC Connectors](#) category:

Click to view products by [THD](#) manufacturer:

Other Similar products are found below :

[00-6200-227-022-800](#) [006205250500825+](#) [006205280500825+](#) [FPH-1602G](#) [086222026001800](#) [52610-0675](#) [62674-201121DLF](#) [52746-1671-TR250](#) [10051922-1610EHLF](#) [10051922-2810EHLF](#) [686322124422](#) [XF3M-2915-1B-R100](#) [AYF353125A](#) [AYF530665TA](#) [AYF534065TA](#) [20FLH-RSM1-TB](#) [207356-1](#) [SFW12R-5STE9LF](#) [SFW18R-1STAE9LF](#) [SFW4R-5STE9LF](#) [52807-0430](#) [046283021002868+](#) [FFC05011-10SBB114W5M](#) [502250-8027](#) [67000-008LF](#) [200528-0260](#) [FH28K-10S-0.5SH](#) [FH52K-6S-0.5SH](#) [0.5K-DX-30PWB](#) [DS1020-08-10VBT12](#) [THD0515-34CL-GF](#) [X05A10L28G](#) [ECC2841061EU](#) [1.0K-DHQX-16PWB](#) [1.0K-DHQX-30PWB](#) [1775333-6](#) [10054365-202110ELF](#) [10054365-242110ELF](#) [10054365-282110ELF](#) [10064555-392220HLF](#) [59453-041110EBHLF](#) [59453-091110EDHLF](#) [62674-241141ALF](#) [62684-432100ALF](#) [62684-451100AHLF](#) [62684-5721N0ALF](#) [HFW11R-1STE1MTLF](#) [HFW12R-1STE9LF](#) [HFW14R-1STE9MTLF](#) [HFW18S-2STE9LF](#)