



深圳市台华达科技有限公司

SHENZHENSHI THD Electronics Co., Ltd.

承 认 书

SPECIFICATION FOR APPROVAL

客户名称:

CUSTOMER.

品 名:

SPECIES.

规 格:

PART NO.

日 期:

DATE.

1.25 WAFER 3.2 卧贴

THD1252-xxWR-SN

2018年10月20日

客户签认(APPROVED SIGNATURES)

核准(APPROVAL)	工程(ENGINEERING)	品管(QC)
核准(APPROVAL)	确认(CHECK)	制作(PREPARE)
	黄德进	LIUYANHONG

办公地址:深圳市松岗街道办红星湾头工业区9栋

TEL:0755-61133661 FAX:0755-61133662

工厂地址:东莞市寮步镇西溪村金兴路275号

标记	处数	更改文件号	签字	日期

规格参数specification parameter			
Circuits	A(mm)	B(mm)	
2Pin	3.10	1.25	
3Pin	4.35	2.50	
4Pin	5.60	3.75	
5Pin	6.85	5.00	
6Pin	8.10	6.25	
7Pin	9.35	7.50	
8Pin	10.60	8.75	
9Pin	11.85	10.00	
10Pin	13.10	11.25	
11Pin	14.35	12.50	
12Pin	15.60	13.75	
13Pin	16.85	15.00	
14Pin	18.10	16.25	
15Pin	19.35	17.50	
16Pin	20.60	18.75	

技术参数 SPECIFICATIONS

间距 (Pitch) : 1.25
 极数 (Poles) : 2~16
 额定电压 (Voltage rating): 125V DC/AC
 额定电流 (Current rating) : 1.0A DC/AC
 耐压值 (Withstand Voltage) : 500VAC/m
 工作温度 (Working Temperature) :
 -25°C ~ +85°C
 绝缘电阻 (Insulation Resistance) : ≥500MΩ
 接触电阻 (Contact resistance) : ≤30mΩ

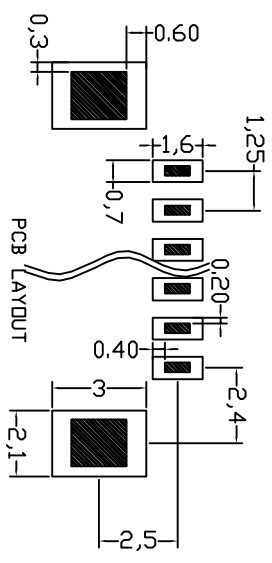
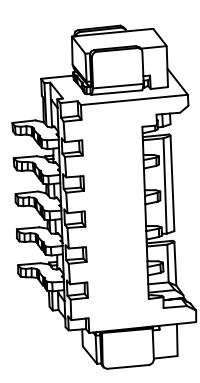
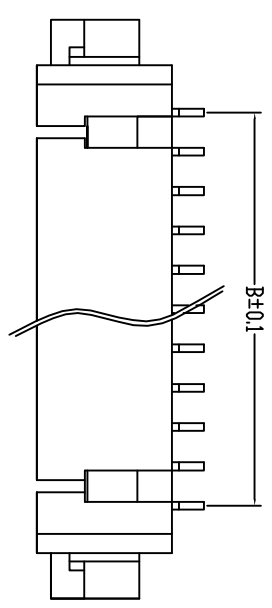
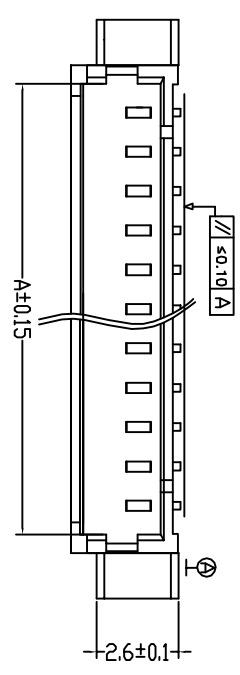
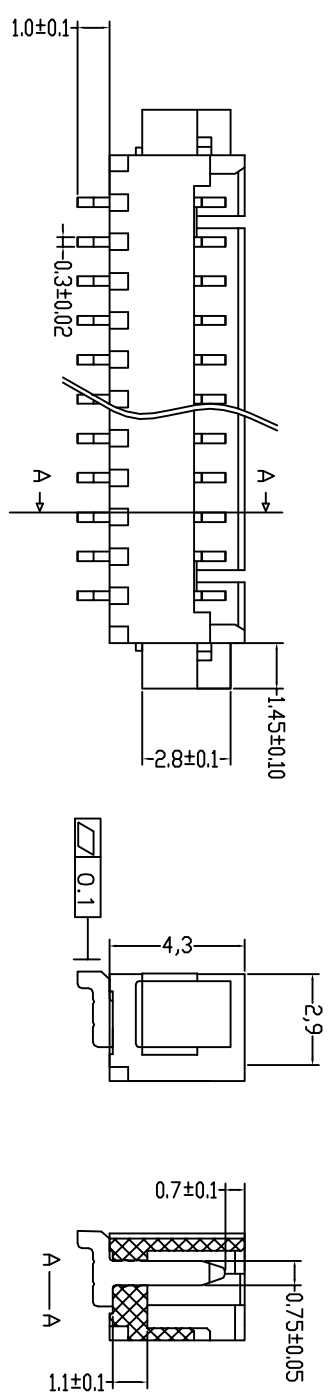

深圳市壹華達科技有限公司
 SHENZHENSHI THD TECHNOLOGY, LTD.

材料 Material
 接触件 (Contact) : 黄铜 t=0.3mm 镀锡 Phosphor
 Bronze Tin-plated
 焊片 (solder tab): 黄铜 t=0.25mm 镀锡 Dark Penter
 Tin-plated
 塑胶主体 (Housing) : 耐热树脂 LCP (UL94V-0) Heat
 resistance plastic (UL94V-0)

X	±0.10	X°	±1°	THD1252-xxWR-SN	通用	成品图	单位: mm
.XX	±0.05	.X°	±0.5°	设计	季育生2017.07.20	文件号	L.V.J.S.CP.045
.XXX	±0.02	.XX°	±0.3°	审核	陶龙耀2017.07.20	版本	页次
	一般尺寸	角度尺寸		批准	吴天朗2017.07.21	比例	A/3 1/1
	未注公差执行						



STANDARD SPECIFICATION

深圳市臺華達科技有限公司

产品规格书

PRODUCT SPECIFICATION

1. 适用范围 SCOPE

本规格书适用于 THD1252-xxWR-SN 连接器系列.

This specification covers the THD1252-xxWR-SN connectors series.

2. 外观尺寸 CONNECTOR DIMENSIONS

请参照图面 See attached drawings.

P. C. B LAYOUT 请参照图面 See attached drawings.

3. 材质 MATERIAL

A. 绝缘胶体 Housing: LCP

颜色 Color: 白色 White

耐燃等级 (UL94V-0) Flammability Rating (UL94V-0).

B. 端子 Terminal: 黄铜 Brass.

C. 焊片 Fitting Nail: 黄铜 Brass.

4. 等级 RATING

项目 ITEM	规格 SPECIFICATIONS
额定电压 (Voltage rating)	125V AC/DC
额定电流 (Current rating)	1.0A DC/AC
使用温度 Operating Temperature range	-25° C ~ +85° C
使用湿度 Operating humidity range	相对湿度 80%以下 Relative humidity 80% max.



STANDARD SPECIFICATION

深圳市臺華達科技有限公司

5. 性能 PERFORMANCE

5.1 电气特性 ELECTRICAL PERFORMANCE

项目 ITEM	测试条件 TEST CONDITION	规格 REQUIRMENT
接触阻抗 Contact Resistance	将样品与适合之插头连接，测试电压 20mV，限电流 10mA 下进行阻抗测试。(EIA-364-23) Mate applicable Plug and measure by dry circuit, 20mV Max, 10mA. (EIA-364-23)	30 mΩ最大. 30 mΩ Max.
绝缘阻抗 Insulation Resistance	将样品与适合之插头连接，提供相邻端子间测试电压 500V DC 进行绝缘阻抗测试(EIA-364-21) Mate applicable Plug and apply 500V DC Between adjacent terminal or ground. (EIA-364-21)	500 MΩ最小. 500 MΩ Min.
耐电压 Dielectric Strength	将样品与适合之插头连接，相邻端子间需可承受 500V AC(m) 1 分钟。(EIA-364-20) Mate applicable Plug, apply 250V AC(m) for 1 Minute between Adjacent Terminal or ground. (EIA-364-20)	目视外观无任何损坏异状 No Breakdown

5.2 机械特性 MECHANICAL PERFORMANCE

项目 ITEM	测试条件 TEST CONDITION	规格 REQUIRMENT
插入力/拔出力 Insertion / hdrawing Force	使用 Plug 以每分钟 25±3mm 速度进行插入力与拔出力测试 Insert the actuator, pull the Plug at a rate of 25±3mm per minute.	插入力最大: Pin*0.2Kgf Insertion: Pin*0.2kgf Max 拔出力最小: Pin*0.05kgf Withdrawal Force: Pin*0.05kgf Min
端子保持力 Terminal Retention Force	端子与基座组装后，以每分钟 25±3mm 速度将端子垂直拔出。 Apply axial pull out force at the rate of 25±3 mm/minute on the terminal assembled in the housing.	0.3kgf 最小 0.3kgf Min



STANDARD SPECIFICATION

深圳市臺華達科技有限公司

项目 ITEM	测试条件 TEST CONDITION	规格 REQUIRMENT
焊片保持力 Fitting Nail Retention Force	焊片与基座组装后，以每分钟 25 ± 3 mm 速度将端子垂直拔出。 Apply axial pull out force at the rate of 25 ± 3 mm/minute on the Fitting Nail assembled in the housing.	0.2kgf 最小 0.2kgf Min

5.3 环境特性及其它性能 ENVIRONMENTAL PERFORMANCE AND OTHERS

项目 ITEM	测试条件 TEST CONDITION	规格 REQUIRMENT	
耐久性 Durability	与 Plug 反复连接，以每分钟小于 10 cycles 连续操作 20 次。 Insert and withdraw actuator up to 20 cycles at the speed rate of less than 10 cycles/minute.	接触阻抗 Contact Resistance	50mΩ最大. 50mΩ Max.

项目 ITEM	测试条件 TEST CONDITION	规格 REQUIREMENT	
耐热性 Heat Resistance	将样品与适合之 Plug 连接，置于环境温度 $85 \pm 2^{\circ} \text{C}$ 测试时间 96 小时，再置于室温下 1~2 小时。 Mate applicable Plug and expose to $85 \pm 2^{\circ} \text{C}$ for 96hours. Upon Completion of the exposure period, the test specimens shall be conditioned at Ambient room conditions for 1 to 2 hours, after which the specified measurements shall be performed.	外观 Appearance	目视外观无任何损坏异状 No Damage
		接触阻抗 Contact Resistance	60mΩ 最大. 60mΩ Max.

项目 ITEM	测试条件 TEST CONDITION	规格 REQUIREMENT	
盐水喷雾 Salt Spray	将样品与 Plug 连接，使用 $5 \pm 1\%$ 浓度盐水，测试温度 $35 \pm 2^{\circ} \text{C}$ ，测试时间 24 ± 4 小时，后于室温下使用清水冲洗后再干燥。 Mate applicable Plug and expose to the following salt mist conditions. Upon completion of the exposure period, salt deposits shall be removed by a gentle wash or dip in running water, after which the Specified measurements shall be performed. NaCl solution Concentration: $5 \pm 1\%$ Spray time: 24 ± 4 hours Ambient temperature: $35 \pm 2^{\circ} \text{C}$	外观 Appearance	目视外观无任何损坏异状 No Damage
		接触阻抗 Contact Resistance	50mΩ 最大. 50mΩ Max.

<p>焊锡性 Solderability</p>	<p>锡温 $245 \pm 5^{\circ} \text{C}$，将导电端子浸入锡炉液面至 Housing 距离锡面 0.1mm 位置，焊锡时间 3 ± 0.5 秒。 Tip of solder tails and fitting nails into the molten solder (held at $245 \pm 5^{\circ} \text{C}$) up to 0.1mm from the bottom of the housing for 3 ± 0.5 seconds.</p>	<p>润湿性 Solder Wetting</p>	<p>润湿面积 95% 以上，并不得有漏焊针孔现象 95% of immersed area must show no voids, pin holes.</p>
<p>焊锡耐热性 Resistance to Soldering Heat</p>	<p>使用回焊时请参考第 6. When reflowing Refer to paragraph 6. 使用烙铁手焊时须可符合下述焊锡条件 Soldering iron method 0.2mm from terminal tip and fitting nail tip. Soldering time : 5 seconds Max. Solder temperature : $370 \sim 400^{\circ} \text{C}$</p>	<p>外观 Appearance</p>	<p>目视外观无任何损坏异状 No Damage</p>

6. 回焊温度曲线 INFRARED REFLOW CONDITION

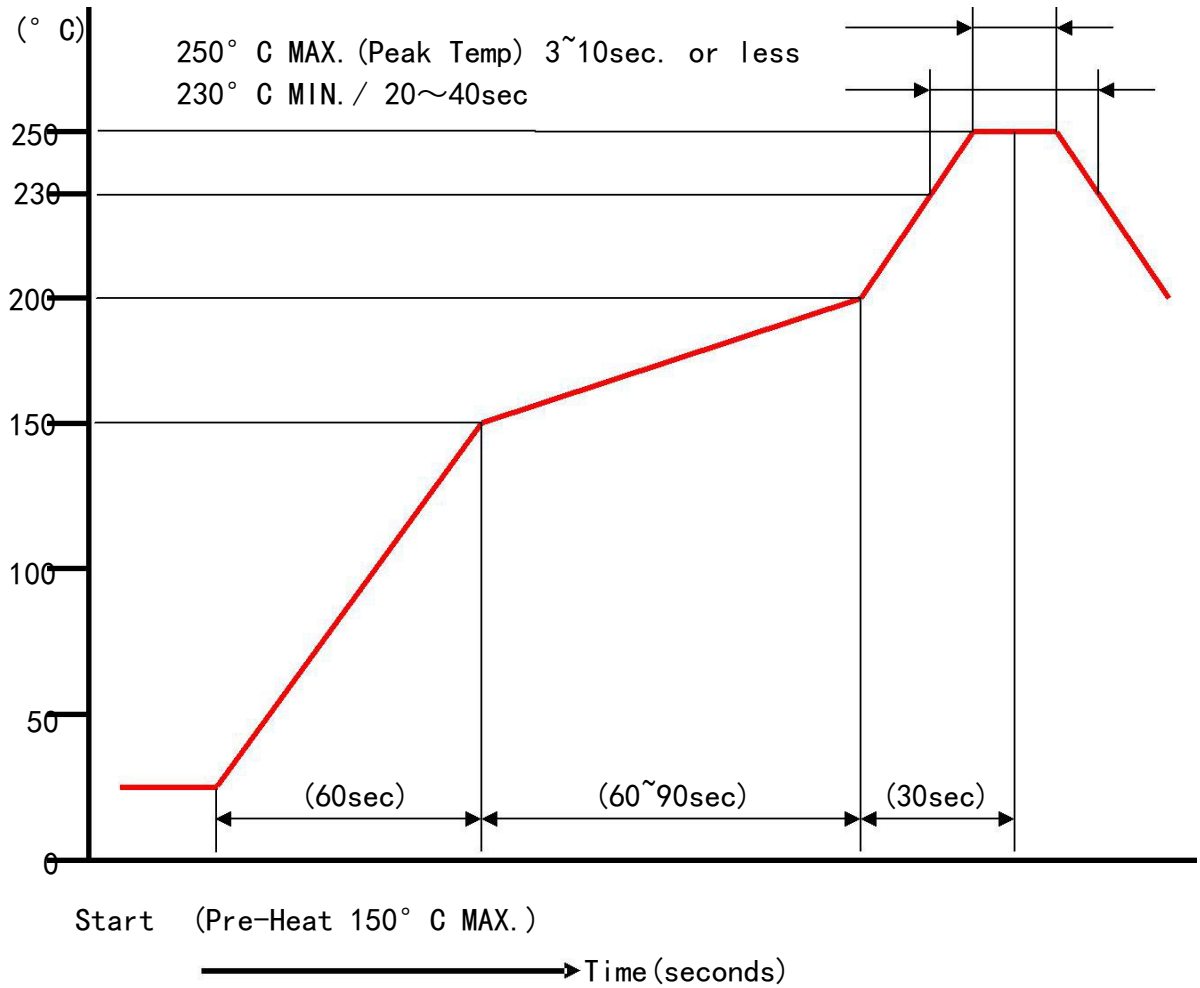

温度条件 TEMPERATURE CONDITION GRAPH (基板表面温度) (TEMPERATURE ON BOARD PATTERN SIDE)



STANDARD SPECIFICATION

深圳市臺華達科技有限公司

7. 包装、运输、贮存

7.1. 包装 Packing

该系列产品包装按照客户要求，有编带、管装等方式。

This series of products are packaged in accordance with customer requirements, such as tape, tube and so on

7.2. 运输 Transportation

允许用任何方式运输，但需避雨、雪直淋和受机械性损伤

Any vehicle can be adopted for the transportation, but moisture-proof and no mechanical damage.

7.3. 贮存 Storage

7.3.1. 包装完毕的连接器的应在环境温度为 $-10^{\circ}\text{C}\sim+40^{\circ}\text{C}$ ，相对湿度不大于 80%，周围空气中没有酸性，碱性及其它腐蚀性气体的库房中贮存。

Temperature: $-10^{\circ}\text{C}\sim+40^{\circ}\text{C}$

Relative humidity: $\leq 80\%$

Not to storage in corrosive environments

7.3.2. 贮存期为 3 个月，超过 3 个月需重新检查。

Re-qualification test shall be conducted immediately while the storage duration exceed 3 months

X-ON Electronics

Largest Supplier of Electrical and Electronic Components

Click to view similar products for [Headers & Wire Housings](#) category:

Click to view products by [THD](#) manufacturer:

Other Similar products are found below :

[95000-104TRLF](#) [10135584-644402LF](#) [DF62W-EP2022PCA](#) [95000-106TRLF](#) [DF62W-2022SCA](#) [DF62W-EP2022PC](#) [2203348](#) [DF62W-2022SC](#) [1084018](#) [1029039](#) [1084017](#) [802-10-012-10-002000](#) [1112640](#) [1112639](#) [891-007-9SS-BST1T](#) [000-34000](#) [0008550134](#) [0009482033](#) [0009507031](#) [57102-F02-18ULF](#) [57102-S06-03LF](#) [57202-S52-04LF](#) [PCN6-15S-2.5E](#) [0039019024](#) [58102-G61-06LF](#) [582553-1](#) [0009485154](#) [0009508121](#) [0022285053](#) [0050291907](#) [018731A](#) [LY20-4P-DT1-P1E-BR](#) [02.125.8002.8](#) [60101931](#) [60598-1 \(Cut Strip\)](#) [M1625-3R/100](#) [61062-3](#) [61082-181009](#) [CSU011177004](#) [636-1427](#) [638009-1](#) [641938-9](#) [641991-4](#) [644168-1](#) [644827-2](#) [647662-1](#) [65039-019ELF](#) [65692-001LF](#) [65781-018](#) [65781-047](#)