



# STANDARD SPECIFICATION

## 产品规格书

客户 Customer: \_\_\_\_\_

客户料号 Customer P/N NO.: \_\_\_\_\_

产品描述 Product Description: 49S 7.3728MHZ 20PF ±20PPM

TKD 料号 TKD P/N. NO.: CD05M0073728RDCAD1

客户批准 Customer Approval :

(请批准后回签一份 PLEASE RETURN A COPY WITH APPROVAL)

TKD SCIENCE AND TECHNOLOGY Co., LTD  
泰晶科技股份有限公司  
Shen zhen Tai jing Industry Co., Ltd.

深圳市泰晶实业有限公司

批准 APPROVED	审核 CHECK	制作 DESIGNER
叶保平	金龙腾	苏婷婷



REV.	Description of Revision History	Date	Designer	Checked By
A	New revision	<u>2020-10-21</u>	<u>Sutingting</u>	<u>Jinlongteng</u>



## CRYSTAL SPECIFICATION

1. Description: Quartz Crystal
2. Nominal Frequency: 7.372800MHz
3. Oscillation Mode: Fundamental
4. Cutting Mode: AT cut
5. Measurement Instrument: S&A 250B(Measured FL)
6. Electrical Characteristics:

[1]Operation Conditions:

Item	Symbol	MIN.	TYP.	MAX.	Unit	Condition
Operating Temperature Range	Topt	-40		85	°C	
Storage Temperature Range	Tstg	-40		85	°C	
Load Capacitance	CL		20		pF	
Drive Level	DL	0.1		100	uW	

[2]Frequency Stability:

Item	Symbol	MIN.	TYP.	MAX.	Unit	Condition
Tolerance	dF/Fo	20		20	ppm	Refer to Center Frequency@25±3°C
Stability Over Temperature	dF/F25	-30		30	ppm	Refer to Operating Temperature @-40~+85°C
Aging	dF/F25	-5		5	ppm	Per Year

dF/Fo:Frequency Deviation Refer to Center Frequency

dF/F25:Frequency Deviation Refer to 25°C Frequency

[3]Electrical Performance:

Item	Symbol	MIN.	TYP.	MAX.	Unit	Condition
Equivalent Series Resistance	ESR			80	Ω	@Series
Shunt Capacitance	C0			7	pF	
Insulation Resistance	IR	500			MΩ	@DC 100 Volt

7. Marking:Laser

TKD:Company Logo  
7.3728:Nominal Frequency

TKD7.3728

8. Outline drawing (unit: mm)

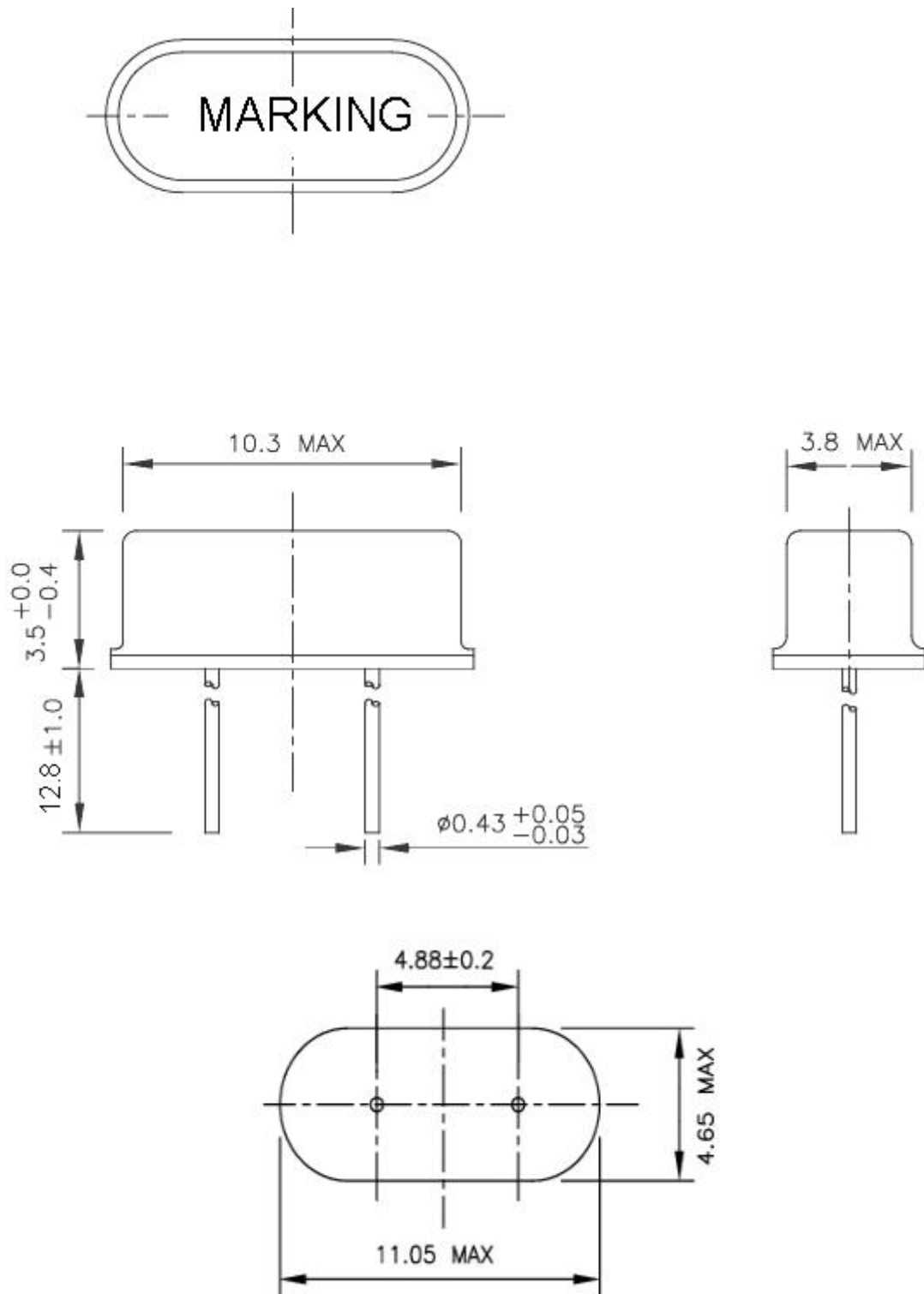



9. Reliability Specification

Test Item	Condition of test	Performance Requirements															
Tensile Strength Termination	The unit's lead wire should withstand a tensile force applied to the termination in the direction of its draw-out axis of up to 1000g maintained as is for 10±2s	There should be no abnormalities detected on the unit															
Solder ability	The lead is immersed in a 235±5°C solder bath within 2±0.5 seconds.	A new uniform coating of solder shall cover min mun 95% of the surface being immersed.															
Vibration	Endurance condition by a frequency sweep shall be made. The entire frequency range from 10HZ to 50HZ and return to 10HZ,shall be transverseb in 1min. Amplitude(total excursion):1.5mm this motion shall be applied for a period of 2h each of 3 mutually perpendicular axes(a total of 6h)	(1).Frequency Change:±5ppm (2).Resistance:±15%															
Drop	Form 70cm height 3 times on 3cm hard wooden floor	(1).Frequency Change:±5ppm (2).Resistance:±15%															
Damp heat	The unit shall be stored at a temperature of 40±2°C with relative humidity of 90%to95% for 48h, then it shall be subjected to standard atmospheric conditions for 1 ~ 2h after which measurement shall be made.	(1).Frequency Change:±5ppm (2).Resistance:±15%															
Dry heat	The unit shall be stored at a temperature of 100°C±5°C for 24h, then it shall be subjected to standard atmospheric conditions for 1~2h after which measurement shall be made.	(1).Frequency Change:±5ppm (2).Resistance:±15%															
Cold	The unit shall be stored at a temperature of -40°C±5°C for 48h, then it shall be subjected to standard atmospheric conditions for 1~2h after which measurement shall be made.	(1).Frequency Change:±5ppm (2).Resistance:±15%															
Aging	The unit shall be stored at a temperature of 85°C±5°C for 7d then it shall be subjected to standard atmospheric conditions for 1~2h after which measurement shall be made.	Refer to verdict specification															
Temperature cycling	The unit shall be subjected to 5 successive change of temperature cycles, each as show in table below,then it shall be subjected to standard atmospheric conditions for 1 ~ 2h after which measurement shall be made <table border="1" data-bbox="400 1668 1062 1962"> <thead> <tr> <th></th> <th>Temperature</th> <th>Duration</th> </tr> </thead> <tbody> <tr> <td>1</td> <td>-40°C±3°C</td> <td>30min</td> </tr> <tr> <td>2</td> <td>Standard atmospheric conditions</td> <td>Within 30s</td> </tr> <tr> <td>3</td> <td>100°C±3°C</td> <td>30min</td> </tr> <tr> <td>4</td> <td>Standard atmospheric conditions</td> <td>Within 30s</td> </tr> </tbody> </table>		Temperature	Duration	1	-40°C±3°C	30min	2	Standard atmospheric conditions	Within 30s	3	100°C±3°C	30min	4	Standard atmospheric conditions	Within 30s	Refer to verdict specification
	Temperature	Duration															
1	-40°C±3°C	30min															
2	Standard atmospheric conditions	Within 30s															
3	100°C±3°C	30min															
4	Standard atmospheric conditions	Within 30s															

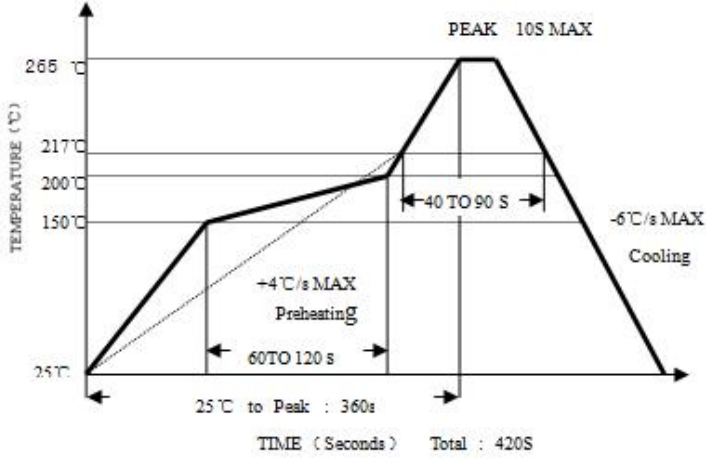

Test Item	Condition of test	Performance Requirements
Sealing	The crystal filter unit shall be immersed in a industry alcohol for 5±0.5 minutes then 25±3°C 1~2 Hr before testing	Insulation Resistance>500MΩ
Resistance to soldering heat	 <p>Reflow soldering cure see the chart. Soldering iron method: Bit temperature: 350°C±10°C Application time of soldering iron:5s Max</p>	Refer to verdict specification



10.1. inner box

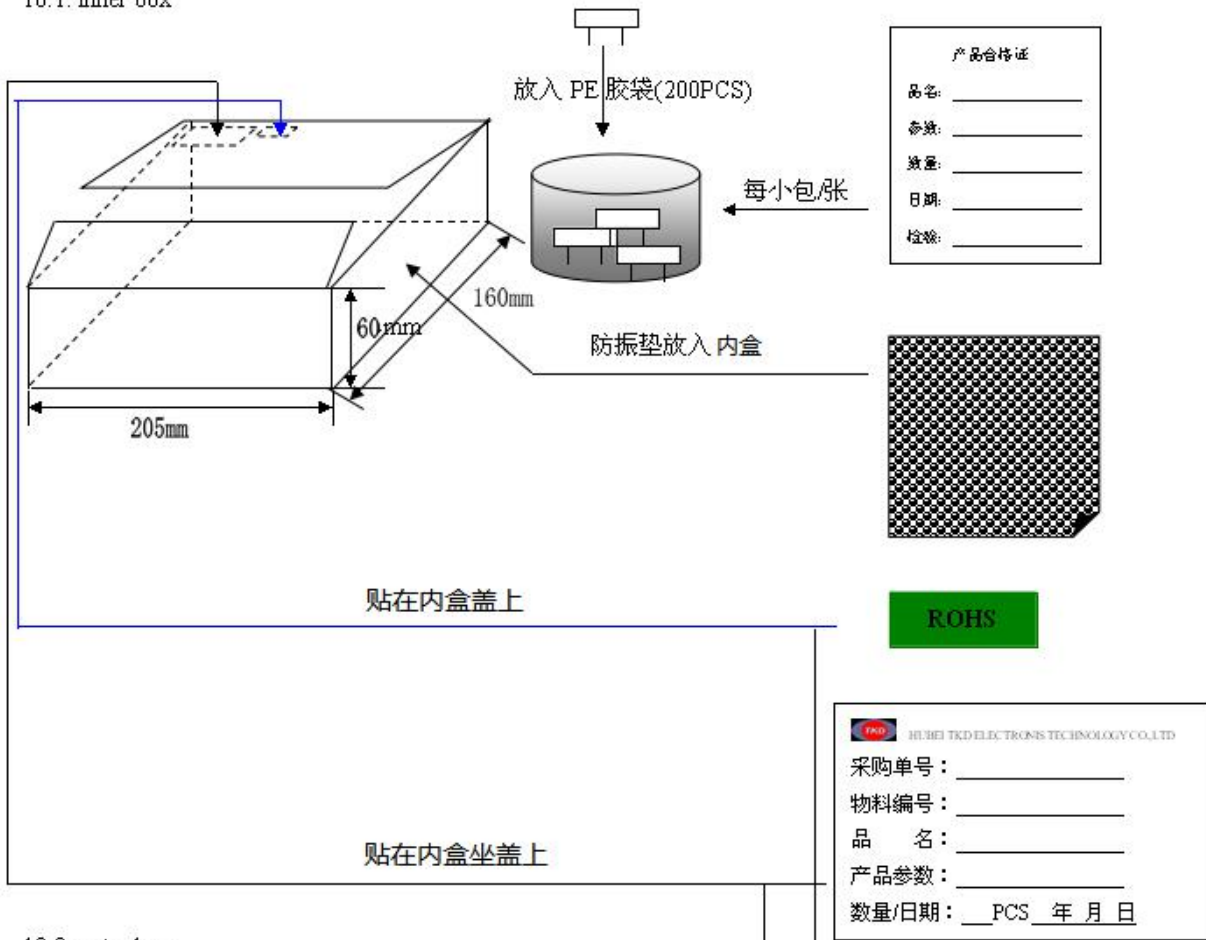

10.2. outer box

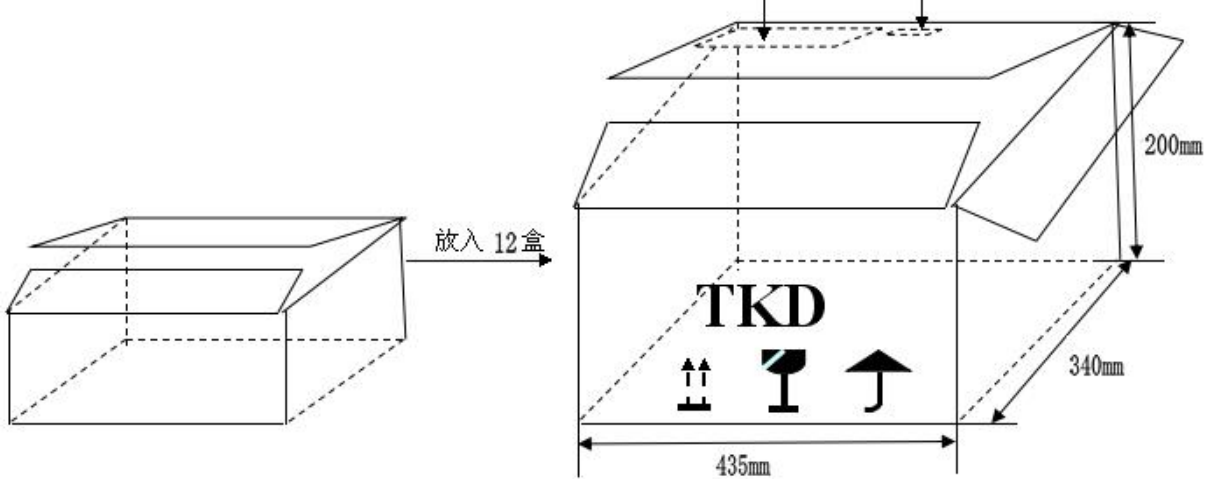

## X-ON Electronics

Largest Supplier of Electrical and Electronic Components

*Click to view similar products for [Crystals](#) category:*

*Click to view products by [TKD](#) manufacturer:*

Other Similar products are found below :

[CX3225GB25000M0PPSZ1](#) [718-13.2-1](#) [7A-40.000MAAE-T](#) [FL2000085](#) [99-BU](#) [9B-15.360MBBK-B](#) [9C-7.680MBBK-T](#) [H10S-12.000-18-EXT-TR](#) [ABC2-6.000MHZ-D4Z-T](#) [ABLS-20.000MHZ-D2-T](#) [ABM3B-27.000MHZ-D4Y-T](#) [ABS071-32.768KHZ-6-T](#) [R38-32.768-12.5-5PPM-NPB](#) [BTD1062E05A-513](#) [21U15A-21.4MHZ](#) [RTX-781DF1-S-20.950](#) [LFXTAL066198Cutt](#) [9C-14.31818MBBK-T](#) [A-11.000MHZ-27](#) [ABL-27.000MHZ-B4Y-T](#) [ABM11-132-24.000MHZ-T3](#) [ABM3B1-25.000MHZ-D2Y-T](#) [SPT2A-.032768B](#) [SPT2A.032768G](#) [SSPT7F-9PF20-R](#) [LFXTAL065253Cutt](#) [LFXTAL066431Cutt](#) [XT9S20ANA14M7456](#) [XT9SNLANA16M](#) [7A-24.576MBBK-T](#) [7B-30.000MBBK-T](#) [MMCC2R32.7680KHZ](#) [7A-14.31818MBBK-T](#) [6504-202-1501](#) [6526-202-1501](#) [ABLS-12.000MHZ-B2Y-T](#) [7A-10.000MBBK-T](#) [SG636PCE-20.000MC](#) [3404](#) [E1SAA18-25.000M](#) [TR](#) [CM315D32768EZFT](#) [C1E-24.000-7-2020-R](#) [C1E-19.200-12-1530-X-R](#) [C1E-16.000-12-1530-X-R](#) [ABM11-16.000MHZ-9-B1U-T](#) [FL5000014](#) [EUCA18-3.1872M](#) [FX0800015](#) [425F35E027M0000](#) [FP0800018](#)