



# STANDARD SPECIFICATION

## 产品规格书

客户 Customer: \_\_\_\_\_

客户料号 Customer P/N NO.: \_\_\_\_\_

产品描述 Product Description: SX-2016 25.000MHZ 18PF ±10PPM

TKD 料号 TKD P/N. NO.: SX20Y025000BI1T008

客户批准 Customer Approval :

(请批准后回签一份 PLEASE RETURN A COPY WITH APPROVAL)

### 泰晶科技股份有限公司

TKD SCIENCE AND TECHNOLOGY CO., LTD.

批准 APPROVED	审核 CHECK	制作 DESIGNER
熊峰	彭朝阳	刘嫚



REVISION RECORD

Rev	Date	NO.	Description of Revision History
00	2023-04-27		New Publication
01	2024-03-02		Update: Reliability Specification

地址：湖北省随州市曾都经济开发区交通大道 1131 号

ADD: 1311 jiaotong Avenue, Suizhou , Hubei

SALES TEL: 0722-3308212, FAX: 0722-3309619, URL: [www.sztkd.com](http://www.sztkd.com)

**Spec Sheet Contents**

NO.	Content	Page
1	石英晶体参数规格 QUARTZ CRYSTAL UNIT SPECIFICATION	4-5
2	产品图纸 DIMENSIONS	6
3	印字内容 MARKING	6
4	内部结构 INSIDE STRUCTURE	7
5	等效电路图 EQUIVALENT CIRCUIT	7
6	包装 PACKING	8
7	回流焊温度曲线 REFLOW PROFILES	9
8	可靠性试验 RELIABILITY SPECIFICATIOND	10-12
9	有害物质含量声明 HARMFUL SUBSTANCE CONTENT STATEMENT	13



## 1. 石英晶体参数规格 QUARTZ CRYSTAL UNIT SPECIFICATION

- ※描述 Description : Quartz Crystal  
 ※产品型别 Product Type : SX-2016  
 ※水晶切割模式 Crystal cutting type : AT-CUT  
 ※测量设备 Measure equipment : S&A 250B  
 ※电气特性 Electrical Characteristics

项目 Item	代码 Symbol	电气特性规格 Electrical Specification				单位 Units	备注 Notes
		下限 Min.	中心 Typ.	上限 Max.			
1 一般频率 Nominal Frequency	F0	25.000000			MHz		
2 振荡模式 Oscillation Mode	-	Fundamental			-		
3 负载电容 Load Capacitance	CL	18			pF		
4 频率公差 Frequency Tolerance	-	-10	-	10	ppm	At 25°C ± 3°C	
5 等效串联电阻 Equivalent Series Resistance	ESR	-	-	60	Ω		
6 驱动功率 Drive Level	DL	-	-	100	μW		
7 频率稳定度 Frequency Stability	TC	-30	-	30	ppm	Over Operating Temp. Range (Ref. to 25°C)	
8 动作温度 Operating Temperature	-	-40	-	85	°C		
9 储存温度 Storage Temperature	-	-40	-	85	°C		
10 年老化率 Aging	-	-3	-	3	ppm	Per Year	
11 绝缘阻抗 Insulation Resistance	-	500	-	-	MΩ	At DC 100V	
12 并联电容 Shunt Capacitance	C0	-	-	3	pF		

地址：湖北省随州市曾都经济开发区交通大道 1131 号

ADD: 1311 jiaotong Avenue, Suizhou, Hubei

SALES TEL: 0722-3308212, FAX: 0722-3309619, URL: [www.sztkd.com](http://www.sztkd.com)



## 备注 Notes:

## 1. 超声波清洗 Ultrasonic cleaning

一般的清洁液或超声波清洗方法可以用来清洗我们的产品。但是，在某些情况下，超声波清洗机在我们产品的振荡频率上会产生共振，从而使器件的电气特性恶化，甚至损坏器件的整体结构。因此，建议超声波清洗前进行验证测试。General cleaning solutions or ultrasonic cleaning method may be used to clean our products. However, under certain circumstances, ultrasonic cleaning machine could generate resonance at the oscillation frequency of our products and thus deteriorate the electrical characteristics in devices, and even damage the overall structure of devices. Therefore, verification test is recommended before cleaning.

## 2. 超声波焊接 Ultrasonic welding

避免使用超声波焊接进行安装和加工，这种方法有可能使晶体产品内部产生过大的振动扩散，成为特性退化而不振动的的原因。Avoid mounting and processing by Ultrasonic welding this method has a possibility of an excessive vibration spreading inside the crystal products and becoming the cause of characteristic deterioration and not oscillating.

## 3. 储存温度说明 Storage temperature description

储存温度仅适用于产品，而包装材料储存温度 5°C~40°C。Storage Temperature is only for the product itself, the temperature for the packing material is 5°C~40°C.

## 4. 手工焊建议条件 Recommended conditions for manual welding

温度：350±10°C，时间：3秒 Max，次数：2次 Max。Temperature: 350 ± 10 °C, Time: 3 sec max, Re-solder times: twice max.

## 5. 本产品不应用于有毒、有害或腐蚀性环境，如汞、氯、硫、酸碱环境等。

This product should not be used in toxic, harmful, or corrosive environments such as mercury, chlorine, sulfur, acid-base environments etc.



2. 产品图纸 DIMENSIONS (Units:mm)

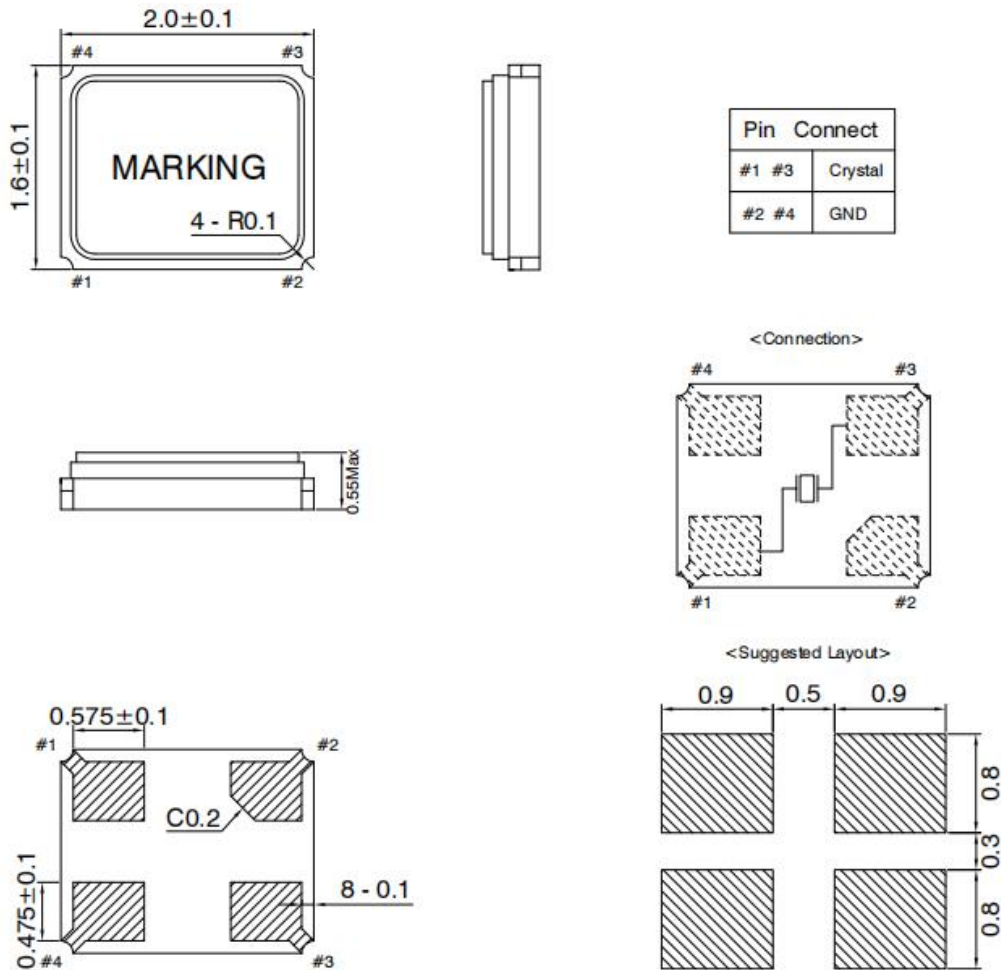

3. 印字 MARKING

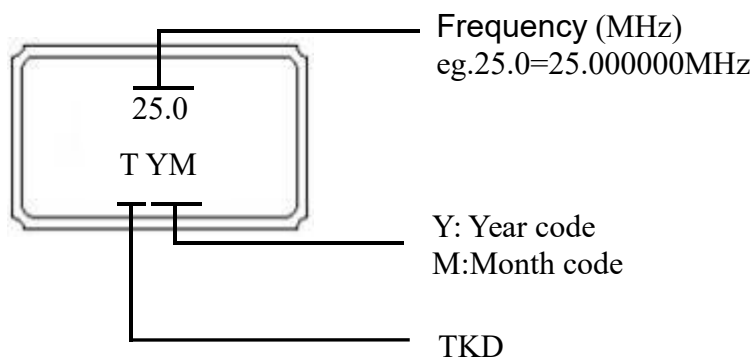

Year	2021	2022	2023	2024	2025	2026	2027	2028	2029	2030	/	/
Year code	1	2	3	4	5	6	7	8	9	0	/	/
*The Year code will be cycled every ten years.												
Month	1	2	3	4	5	6	7	8	9	10	11	12
Month code	A	B	C	D	E	F	G	H	J	K	L	M

地址：湖北省随州市曾都经济开发区交通大道 1131 号

ADD: 1311 jiaotong Avenue, Suizhou, Hubei

SALES TEL: 0722-3308212, FAX: 0722-3309619, URL: [www.sztkd.com](http://www.sztkd.com)

4. 内部结构产品图纸 INSIDE STRUCTURE



No.	组件 COMPONENTS	材料成份 MATERIALS
1	基座 Package	陶瓷 Ceramic (Al2O3)
2	外壳 LID	KV 合金 KV (Fe/Co/Ni)
3	水晶片 Crystal blank	二氧化硅 SiO2
4	电极 Electrode	贵金属银 Noble Metal (Ag)
5	接着剂 Adhesive	树脂、银粉 Resin, Ag

5. 等效电路图 EQUIVALENT CIRCUIT

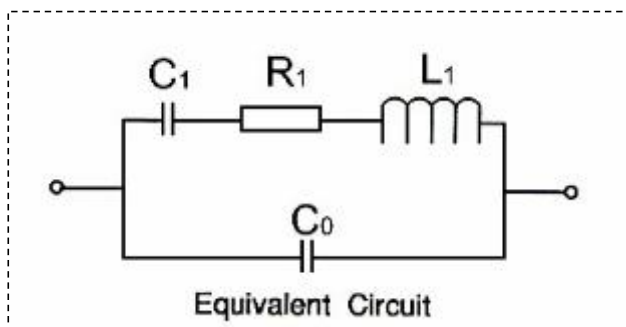

**6. 包装 PACKING (Units:mm)**

※载带类型 CARRIER TYPE

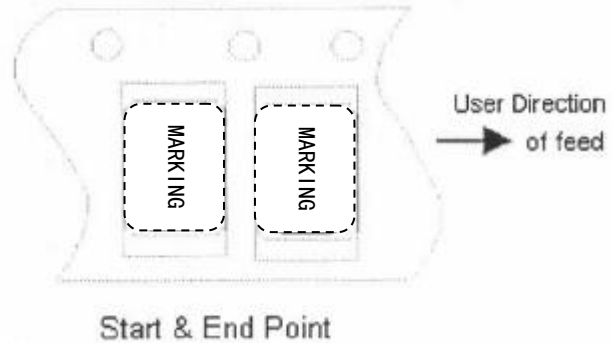
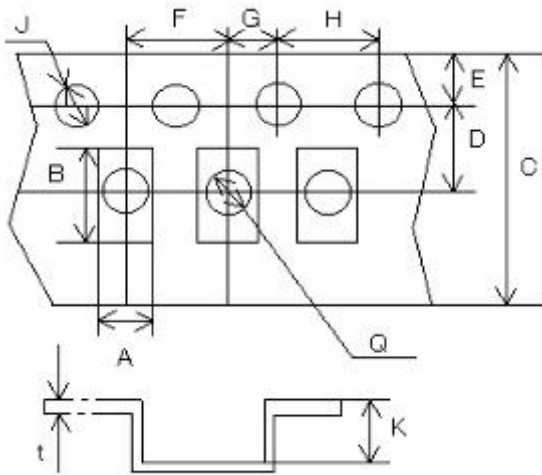

A	B	C	D	E	F	G	H	J	K	t
1.90	2.30	8.0	3.5	1.75	4.0	2.0	4.0	1.55	0.65	0.25

备注 REMARK:



※圆卷 REEL: 3000 PCS/Reel



M	N	P	Q	R	S	U
178.0	60.2	11.5	8.0	2.5	11.0	13.0

地址: 湖北省随州市曾都经济开发区交通大道 1131 号

ADD: 1311 jiaotong Avenue, Suizhou, Hubei

SALES TEL: 0722-3308212, FAX: 0722-3309619, URL: [www.sztkd.com](http://www.sztkd.com)





### 7. 回流焊温度曲线 REFLOW PROFILES

参考标准 REFER: JEDEC J-STD-020D

Profiles Feature	Pb-Free Assembly
Preheat/Soak	
Temperature Min (Ts min)	150°C
Temperature Max (Ts max)	200°C
Time (Ts) from (Ts min to Ts max)	60-120 seconds
Ramp-up rate (TL to TP)	3°C/second max.
Liquidous temperature (TL)	217°C
Time (TL) maintained above TL	60-150 seconds
Peak/Classification Temperature (TP)	260±5°C
Time within 5°C of actual Peak Temperature (TP)	20~40 seconds
Ramp-down rate (TP to TL)	6°C/second max.
Time 25°C to peak temperature	8 minutes max.
Suggest reflow times	3 Times max

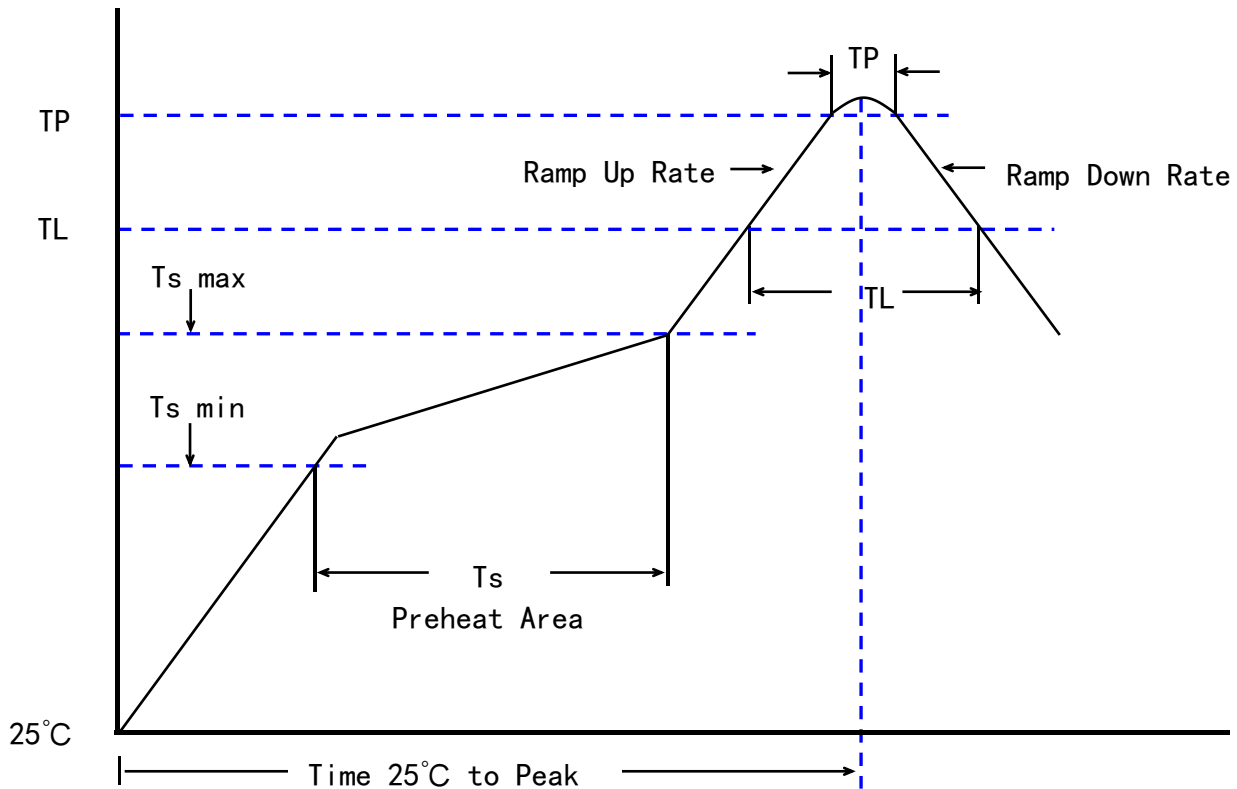

地址: 湖北省随州市曾都经济开发区交通大道 1131 号

ADD: 1311 jiaotong Avenue, Suizhou, Hubei

SALES TEL: 0722-3308212, FAX: 0722-3309619, URL: [www.sztkd.com](http://www.sztkd.com)



## 8. 可靠性试验 RELIABILITY SPECIFICATION

参考标准 REFER		JIS C 6701											
NO.	项目 ITEM	测试条件 CONDITIONS	测试标准 CRITERIA										
1	高温试验 HIGH TEMPERATURE	<p>温度<math>125 \pm 2^{\circ}\text{C}</math>存储<math>720 \pm 12</math>小时;然后在常温(<math>25 \pm 2^{\circ}\text{C}</math>)下静置2H以上24H内使用250B测试特性参数。 如果客户的温度要求是高于标准, 温度测试必须完成客户的需求。</p> <p>STORED AT <math>125 \pm 2^{\circ}\text{C}</math> FOR <math>720 \pm 12\text{H}</math>. THE CHARACTERISTIC PARAMETERS OF 250B MUST BE TESTED IN 24H AFTER BEING STATIC FOR MORE THAN 2H AT ROOM TEMPERATURE (<math>25 \pm 2^{\circ}\text{C}</math>). IF CUSTOMER'S TEMPERATURE REQUEST IS HIGHER THAN THE STANDARD, TEMPERATURE TEST MUST BE DONE FOR CUSTOMER REQUIREMENTS.</p>	A. C										
2	低温试验 LOW TEMPERATURE	<p>温度<math>-40 \pm 2^{\circ}\text{C}</math>存储<math>500 \pm 12</math>小时;然后在常温(<math>25 \pm 2^{\circ}\text{C}</math>)下静置2H以上24H内测试250B。 如果客户的温度要求是高于标准, 温度测试必须完成客户的需求。</p> <p>STORED AT <math>-40 \pm 2^{\circ}\text{C}</math> FOR <math>500 \pm 12\text{H}</math>. THE CHARACTERISTIC PARAMETERS OF 250B MUST BE TESTED IN 24H AFTER BEING STATIC FOR MORE THAN 2H AT ROOM TEMPERATURE (<math>25 \pm 2^{\circ}\text{C}</math>). IF CUSTOMER'S TEMPERATURE REQUEST IS HIGHER THAN THE STANDARD, TEMPERATURE TEST MUST BE DONE FOR CUSTOMER REQUIREMENTS.</p>	A. C										
3	高温高湿 HIGH TEMP. & HUMIDITY	<p>温度<math>85 \pm 2^{\circ}\text{C}</math>, 湿度85%环境下存储<math>500 \pm 12</math>小时;然后在常温(<math>25 \pm 2^{\circ}\text{C}</math>)下静置2H以上24H内测试250B。</p> <p>STORED AT <math>85 \pm 2^{\circ}\text{C}</math> AND HUMIDITY 85% FOR <math>500 \pm 12\text{H}</math>. THE CHARACTERISTIC PARAMETERS OF 250B MUST BE TESTED IN 24H AFTER BEING STATIC FOR MORE THAN 2H AT ROOM TEMPERATURE (<math>25 \pm 2^{\circ}\text{C}</math>).</p>	A. C. D										
4	温度冲击 TEMPERATURE SHOCK	<p>晶振单元应运行100个温度冲击, 然后在常温(<math>25 \pm 2^{\circ}\text{C}</math>)下静置2H以上24H内测试250B。每个温度冲击条件如下:</p> <table border="1"> <thead> <tr> <th>温度</th> <th>持续时间</th> </tr> </thead> <tbody> <tr> <td>1. <math>-40+0/-6^{\circ}\text{C}</math></td> <td>30 <math>\pm</math> 3MINUTES 分钟</td> </tr> <tr> <td>2. <math>25^{\circ}\text{C} \pm 2^{\circ}\text{C}</math></td> <td>2 <math>\sim</math> 3MINUTES 分钟</td> </tr> <tr> <td>3. <math>125+4/-0^{\circ}\text{C}</math></td> <td>30 <math>\pm</math> 3MINUTES 分钟</td> </tr> <tr> <td>4. <math>25^{\circ}\text{C} \pm 2^{\circ}\text{C}</math></td> <td>2 <math>\sim</math> 3MINUTES 分钟</td> </tr> </tbody> </table> <p>THE CRYSTAL UNIT SHALL BE SUBJECTED TO 100 SUCCESSIVE CHANGE OF TEMPERATURE CYCLES. THE CHARACTERISTIC PARAMETERS OF 250B MUST BE TESTED IN 24H AFTER BEING STATIC FOR MORE THAN 2H AT ROOM TEMPERATURE (<math>25 \pm 2^{\circ}\text{C}</math>).</p>	温度	持续时间	1. $-40+0/-6^{\circ}\text{C}$	30 $\pm$ 3MINUTES 分钟	2. $25^{\circ}\text{C} \pm 2^{\circ}\text{C}$	2 $\sim$ 3MINUTES 分钟	3. $125+4/-0^{\circ}\text{C}$	30 $\pm$ 3MINUTES 分钟	4. $25^{\circ}\text{C} \pm 2^{\circ}\text{C}$	2 $\sim$ 3MINUTES 分钟	A. C
温度	持续时间												
1. $-40+0/-6^{\circ}\text{C}$	30 $\pm$ 3MINUTES 分钟												
2. $25^{\circ}\text{C} \pm 2^{\circ}\text{C}$	2 $\sim$ 3MINUTES 分钟												
3. $125+4/-0^{\circ}\text{C}$	30 $\pm$ 3MINUTES 分钟												
4. $25^{\circ}\text{C} \pm 2^{\circ}\text{C}$	2 $\sim$ 3MINUTES 分钟												

地址: 湖北省随州市曾都经济开发区交通大道 1131 号

ADD: 1311 jiaotong Avenue, Suizhou, Hubei

SALES TEL: 0722-3308212, FAX: 0722-3309619, URL: [www.sztkd.com](http://www.sztkd.com)



5	可焊性 SOLDERABILITY	焊锡温度 $245 \pm 5^{\circ}\text{C}$ ，时间 $2 \pm 0.6$ 秒，无铅锡料，加助焊剂。 THE LEAD IS IMMERSED IN A $245 \pm 5^{\circ}\text{C}$ SOLDER BATH WITHIN $2 \pm 0.6$ SECONDS.	G
6	粗漏 GROSS LEAK	自动粗漏检测仪的标准件，测试压力：0.2MPA STANDARD PART OF AUTOMATIC GROSS LEAKAGE DETECTOR, TEST PRESSURE: 0.2MPA	E
7	氦漏 FINE LEAK	5.0~5.5 KGF / $\text{CM}^2$ 的氦气加压 2 小时 HELIUM BOMBING 5.0~5.5 KGF / $\text{CM}^2$ , FOR 2 HOURS.	F
8	耐焊接热性 WELDING HEAT RESISTANCE	过回流焊 3 次，最高温度&时间 $260^{\circ}\text{C} \pm 5^{\circ}\text{C}$ ， $15 \pm 5$ SEC；然后在常温 ( $25 \pm 2^{\circ}\text{C}$ ) 下静置 4H 以上 24H 内测试 250B。 3 REFLAWS, THE MAXIMUM TEMPERATURE & TIME IS $260^{\circ}\text{C} \pm 5^{\circ}\text{C}$ , $15 \pm 5$ SEC. THE CHARACTERISTIC PARAMETERS OF 250B MUST BE TESTED IN 24H AFTER BEING STATIC FOR MORE THAN 2H AT ROOM TEMPERATURE ( $25 \pm 2^{\circ}\text{C}$ ).	A. C
9	跌落 FREE FALL	从 100CM 的高度自由落体 3 次，落在坚硬的木板上。 FREE DROPPING FROM 100CM HEIGHT 3 TIMES ON A HARD	A. C
10	振动 VIBRATION	振动频率：10~55HZ，振幅(全程)：扫频率 0.750CT/MIN，加速度峰值 5G，3 个方向(X, Y, Z) 各 2 小时。 FREQUENCY: 10~55HZ AMPLITUDE (TOTAL EXCURSION): THE SCANNING FREQUENCY IS 0.750CT/MIN, AND THE PEAK ACCELERATION IS 5G. SWEEP TIME: 3 DIRECTION (X, Y, Z) EACH FOR 2 HRS.	A. C
11	板弯曲 TERMINAL STRENGTH	以约 0.5MM/秒的速度施加压力，直到折板弯曲达到 3MM，维持 5 秒钟。 SHALL BE PRESSURIZED AT A SPEED OF APPROX. 0.5MM/SEC IN THE DIRECTION INDICATED BY THE ARROW UNTIL THE BENDING WIDTH REACHES 3MM AND HELD FOR 5 SECONDS.	A. C

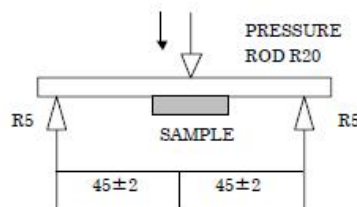

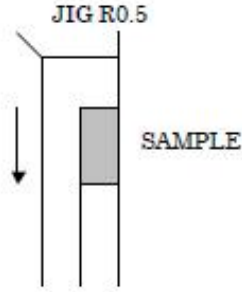
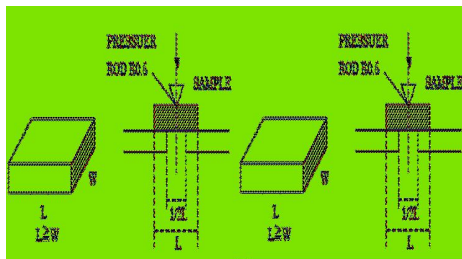

12	折板推力试验 STICKING TENDENCY	<p>在 R0.5 的可移动治具上最终施加一个 10N 的力，维持 10 秒钟。 A R0.5 JIG SHALL BE USED TO APPLY A 10N DEAD LOAD IN THE DIRECTION INDICATED BY THE ARROW TO THE ELEMENT AND RETAIN IT FOR 10 SECONDS.</p>	A. C
			
13	本体荷重试验 ELEMENT ASSEMBLY STRENGTH	<p>使用一个 R0.5 的压杆在元件中心施加一个 10N 的力，维持 10 秒钟。 A R0.5 PRESSURIZED BAR SHALL BE USED TO APPLY A 10N LOAD IN THE CENTER OF ELEMENT AND RETAIN IT FOR 10 SECONDS.</p>	A. C
			
14	机械冲击 MECHANICAL SHOCK	<p>100G, 6MS, 半正弦冲击脉冲 6 轴*3 次 100G, 6MS, HALF SINE SHOCK PULSE, 6AXIS*3TIMES</p>	A. C

**SPECIFICATIONS**

A	FREQUENCY CHANGE PERMITTED.	$\Delta F \leq 5\text{PPM}$
B	FREQUENCY CHANGE PERMITTED.	$\Delta F \leq 10\text{PPM}$
C	EQUIVALENT SERIES RESISTANCE CHANGE PERMITTED.	$\Delta CI \leq 5\Omega$ or 15% Make use larger value
D	INSULATION RESISTANCE	$> 500\text{M}\Omega$
E	PRESSURE GAP LESS THAN	$< 1 \times 10^{-4} \text{ Pa} \cdot \text{m}^3 / \text{sec}$
F	LEAK RATE LESS THAN	$< 1 \times 10^{-9} \text{ Pa} \cdot \text{m}^3 / \text{sec}$
G	A NEW UNIFORM COATING OF SOLDER SHALL COVER A MINIMUM 95% OF THE SURFACE	

Remark:

※ Each test done independently

※ Measurement condition: Electrical characteristics measured by S&A250B or equivalent.

地址：湖北省随州市曾都经济开发区交通大道 1131 号

ADD: 1311 jiaotong Avenue, Suizhou, Hubei

SALES TEL: 0722-3308212, FAX: 0722-3309619, URL: [www.sztkd.com](http://www.sztkd.com)



9. 有害物质含量声明 HARMFUL SUBSTANCE CONTENT STATEMENT  
有毒有害物质或元素的名称及含量表

材料名称	有毒有害物质或元素					
	铅 (Pb)	汞 (Hg)	镉 (Cd)	六价铬 (Cr (VI))	多溴联苯 (PBB)	多溴二苯醚 (PBDE)
BLANK	○	○	○	○	○	○
Package	○	○	○	○	○	○
LID	○	○	○	○	○	○
Electrode	○	○	○	○	○	○
Adhesive	○	○	○	○	○	○
... ..						
... ..						
... ..						
... ..						
... ..						
拆分部件 n						

○：表示该有毒有害物质在该部件所有均质材料中的含量均在 ROHS/REACH/无卤标准规定的限量要求以下；  
×：表示该有毒有害物质至少在该部件的某一均质材料中的含量超出ROHS/REACH/无卤标准规定的限量要求。

## X-ON Electronics

Largest Supplier of Electrical and Electronic Components

*Click to view similar products for [Crystals](#) category:*

*Click to view products by [TKD](#) manufacturer:*

Other Similar products are found below :

[CX3225GB25000M0PPSZ1](#) [718-13.2-1](#) [7A-40.000MAAE-T](#) [FL2000085](#) [99-BU](#) [9B-15.360MBBK-B](#) [9C-7.680MBBK-T](#) [H10S-12.000-18-EXT-TR](#) [ABC2-6.000MHZ-D4Z-T](#) [ABLS-20.000MHZ-D2-T](#) [ABS071-32.768KHZ-6-T](#) [R38-32.768-12.5-5PPM-NPB](#) [BTD1062E05A-513](#) [21U15A-21.4MHZ](#) [RTX-781DF1-S-20.950](#) [LFXTAL066198Cutt](#) [9C-14.31818MBBK-T](#) [A-11.000MHZ-27](#) [ABL-27.000MHZ-B4Y-T](#) [ABM11-132-24.000MHZ-T3](#) [ABM3B1-25.000MHZ-D2Y-T](#) [SPT2A-.032768B](#) [SPT2A.032768G](#) [LFXTAL065253Cutt](#) [LFXTAL066431Cutt](#) [XT9S20ANA14M7456](#) [XT9SNLANA16M](#) [7A-24.576MBBK-T](#) [7B-30.000MBBK-T](#) [CX2520DB16000H0HPQCC](#) [MMCC2R32.7680KHZ](#) [6504-202-1501](#) [6526-202-1501](#) [ABLS-12.000MHZ-B2Y-T](#) [7A-10.000MBBK-T](#) [SG636PCE-20.000MC](#) [3404](#) [CM315D32768EZFT](#) [C1E-24.000-7-2020-R](#) [C1E-19.200-12-1530-X-R](#) [C1E-16.000-12-1530-X-R](#) [ABM11-16.000MHZ-9-B1U-T](#) [FL5000014](#) [EUCA18-3.1872M](#) [FX0800015](#) [425F35E027M0000](#) [FP0800018](#) [MS3V-T1R-32.768kHz-7pF-20PPM-TA-QC-Au](#) [VXM7-1C1-16M000](#) [MS3V-T1R-32.768kHz-9pF-20PPM-TA-QC-Au](#)