

RoHS

STANDARD SPECIFICATION

产品规格书

Customer: _____

Customer Part NO.: _____

Type & Freq: SX-3225 27.120MHZ 10PF ±10PPM

TKD Part NO.: SX32Y027120BA1T

Customer Approval :

(PLEASE RETURN A COPY WITH APPROVAL)

HUBEI TKD ELECTRONICS TECHNOLOGY CO.,LTD.

湖北泰晶电子科技股份有限公司

SUIZHOU TAIWARD ELECTRONIC TECHNOLOGY CO.,LTD

随州泰华电子科技有限公司

APPROVED	CHECK	DESIGNER
J. T Wang	Y Yang	Y. H Liao

REVISION

Rev	Date	NO.	Description of Revision History
00	2017-08-22		New Publication

※ 1. QUARTZ CRYSTAL UNIT SPECIFICATION

1. Frequency: 27.120000MHz
2. Holder type : SX-3225
3. Oscillation Mode: Fundamental
4. Cutting Mode AT cut
5. Measurement Instrument S&A 250B (Measured FL)
6. Frequency Tolerance: ± 10 ppm at $25^{\circ}\text{C} \pm 3^{\circ}\text{C}$
7. Equivalent Series Resistance: 40 Ω Max.
8. Storage Temperature Range: $-40^{\circ}\text{C} \sim +85^{\circ}\text{C}$
9. Operating Temperature $-20^{\circ}\text{C} \sim +70^{\circ}\text{C}$
10. Frequency Stability:
Refer to Operating Temperature ± 15 PPM @ $-20^{\circ}\text{C} \sim +70^{\circ}\text{C}$
11. Drive Level: 100uW/Max
12. Load Capacitance (CL) : 10pF
13. Shunt Capacitance: 3.0pF MAX
14. Insulation resistance : 500M Ω min /DC 100V
15. Aging: ± 3 ppm / Year
16. PACKING: 3000PCS / Reel
17. NOTE:

※ 3. INSIDE STRUCTURE

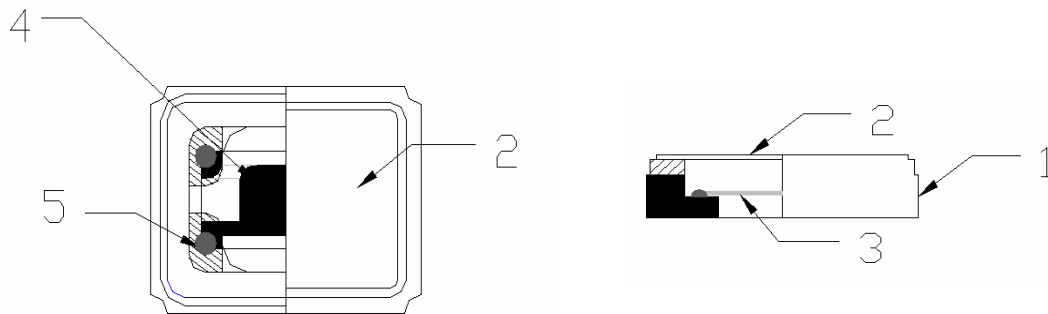

No.	COMPONENTS	MATERIALS
1	Package	Ceramic (Al ₂ O ₃)
2	LID	KV(Fe/Co/Ni)
3	Crystal blank	SiO ₂
4	Electrode	Noble Metal (Ag)
5	Adhesive	Resin、Ag

※ 4. EQUIVALENT CIRCUIT

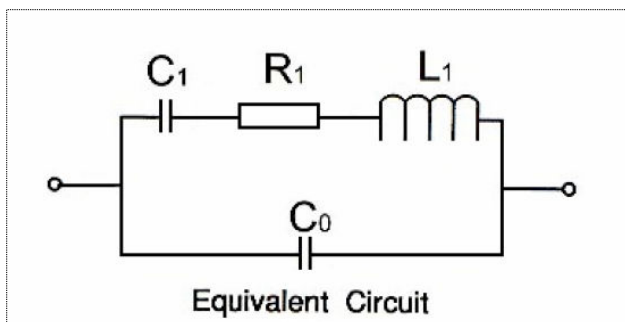

※ 5. RELIABILITY SPECIFICATION

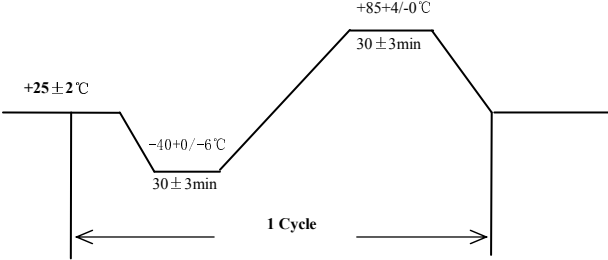
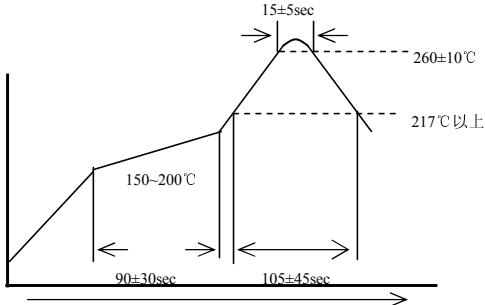
REFER		JIS C 6701	
NO.	ITEM	CONDITIONS	BASIS OF VERDICT
1	FREE FALL	FREE DROPPING FROM 75 cm HEIGHT 3 TIMES ON A HARD	F±5ppm CI±15% or 5Ω
2	VIBRATION	FREQUENCY : 10~55Hz, AMPLITUDE (TOTAL EXCURSION) : 1.5mm±15%, SWEEP TIME : 1MIN, 3 DIRECTION(X, Y, Z) EACH FOR 2 Hrs.	F±5ppm CI±15% or 5Ω
3	TEMPERATURE CYCLE	THE CRYSTAL UNIT SHALL BE SUBJECTED TO 100 SUCCESSIVE CHANGE OF TEMPERATURE CYCLES 	F±5ppm CI±15% or 5Ω
4	FINE LEAK	HELIUM BOMBING 5.0~5.5 Kgf / cm ² , FOR 2 HOURS.	≤1×10 ⁻⁹ Pa.m ³ /s
5	RESISTANCE TO SOLDERING HEAT	PEAK: 260°C ± 10°C Time: 15±5 sec 	F±5ppm CI±15% or 5Ω
6	SOLDERABILITY	THE LEAD IS IMMERSSED IN A 260±5°C SOLDER BATH WITHIN 2±0.6 SECONDS.	more than 95% of lead shall be covered by new solder
7	HIGH TEMP. & HUMIDITY	STORED AT 60±2°C AND HUMIDITY 90~95% FOR 500±12 H.	F±5ppm CI±15% or 5Ω
8	HIGH TEMPERATURE STORAGE	STORED AT 85±2°C FOR 720±12H. (If Customer's temperature request is higher than the standard, Temperature test must be done for customer requirements.)	F±5ppm CI±15% or 5Ω

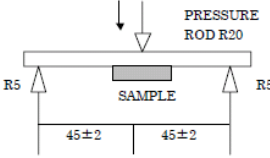
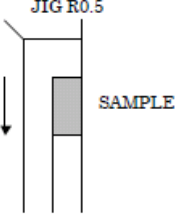
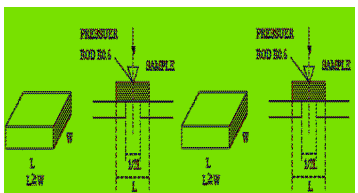
9	LOW TEMPERATURE STORAGE	STORED AT $-40\pm 2^{\circ}\text{C}$ FOR $500\pm 12\text{H}$. (If Customer's temperature request is lower than the standard, Temperature test must be done for customer requirements.)	F \pm 5ppm CI \pm 15% or 5 Ω
10	TERMINAL STRENGTH	<p>SHALL BE PRESSURIZED AT A SPEED OF APPROX.0.5mm/sec IN THE DIRECTION INDICATED BY THE ARROW UNTIL THE BENDING WIDTH REACHES 3mm AND HELD FOR 5 SECONDS.</p> 	F \pm 5ppm CI \pm 15% or 5 Ω
11	STICKING TENDENCY	<p>A R0.5 JIG SHALL BE USED TO APPLY A 10N DEAD LOAD IN THE DIRECTION INDICATED BY THE ARROW TO THE ELEMENT AND RETAIN IT FOR 10 SECONDS.</p> 	F \pm 5ppm CI \pm 15% or 5 Ω
12	ELEMENT ASSEMBLY STRENGTH	<p>A R0.5 PRESSURIZED BAR SHALL BE USED TO APPLY A 10N LOAD IN THE CENTER OF ELEMENT AND RETAIN IT FOR 10 SECONDS.</p> 	F \pm 5ppm CI \pm 15% or 5 Ω

※ 7. FLOW CHART

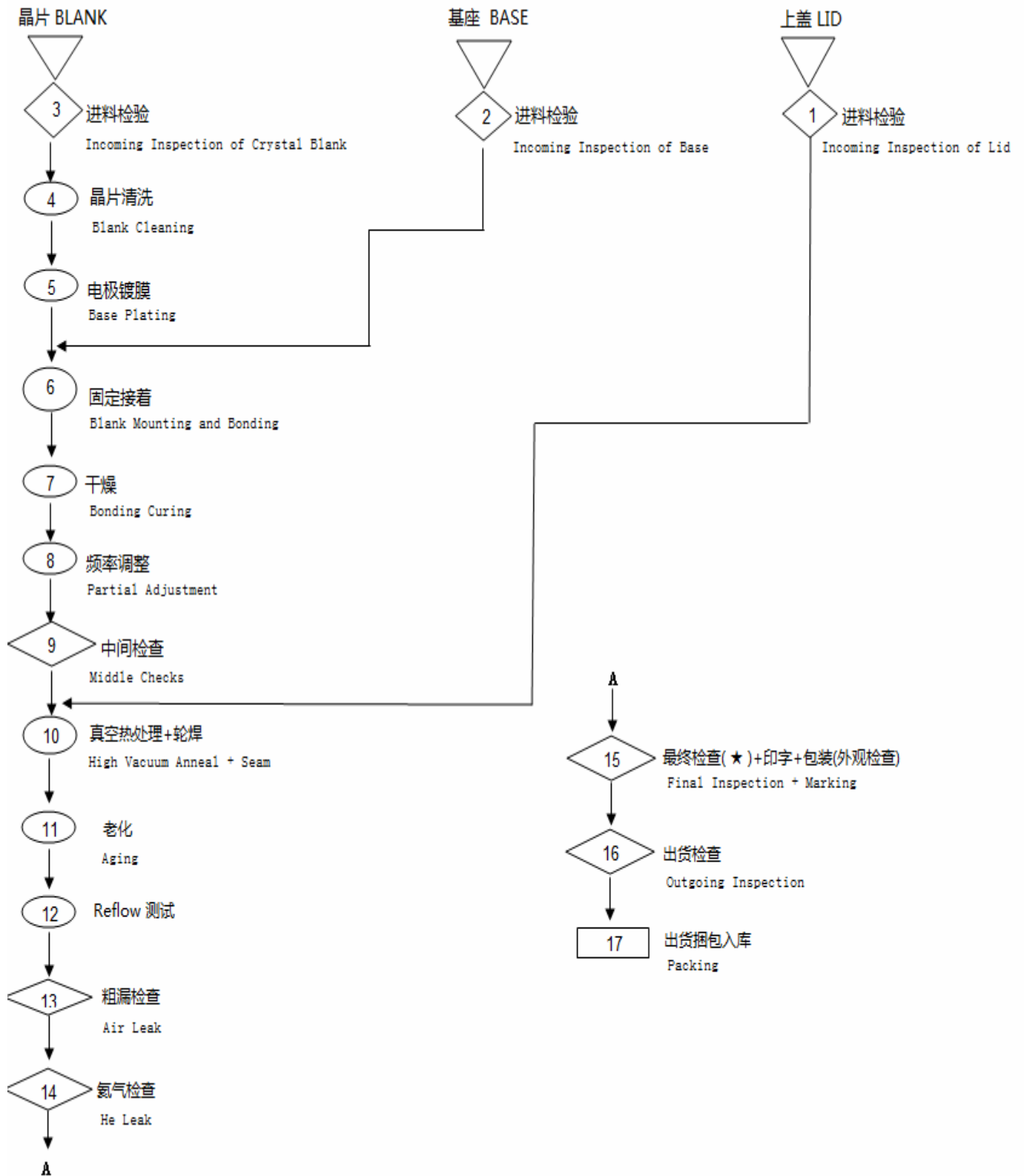

※ 8. HARMFUL SUBSTANCE CONTENT STATEMENT

随州泰华电子科技有限公司 SX-3225 产品 有毒有害物质或元素的名称及含量表

材料名称	有毒有害物质或元素						备注
	铅 (Pb)	汞 (Hg)	镉 (Cd)	六价铬 (Cr(VI))	多溴联苯 (PBB)	多溴二苯醚 (PBDE)	
BLANK	ND	ND	ND	ND	ND	ND	
Package	ND	ND	ND	ND	ND	ND	
LID	ND	ND	ND	ND	ND	ND	
Electrode	ND	ND	ND	ND	ND	ND	
Adhesive	ND	ND	ND	ND	ND	ND	
... ..							
... ..							
... ..							
... ..							
... ..							
拆分部件 n							

○：表示该有毒有害物质在该部件所有均质材料中的含量均在 SJ/T11363-2006 规定的限量要求以下
 ×：表示该有毒有害物质至少在该部件的某一均质材料中的含量超出 SJ/T11363-2006 规定的限量要求。
 (供应商应将其原材料按要求进行拆分，并按照此表格进行详细标注,对不能满足标准要求的零部件进行具体的原因描述)

X-ON Electronics

Largest Supplier of Electrical and Electronic Components

Click to view similar products for [Crystals](#) category:

Click to view products by [TKD](#) manufacturer:

Other Similar products are found below :

[CX3225GB25000M0PPSZ1](#) [718-13.2-1](#) [MC405 32.0000K-R3:PURE SN](#) [7A-40.000MAAE-T](#) [FL2000085](#) [99-BU](#) [9B-15.360MBBK-B](#) [9C-7.680MBBK-T](#) [H10S-12.000-18-EXT-TR](#) [ABC2-6.000MHZ-D4Z-T](#) [ABLS-20.000MHZ-D2-T](#) [ABS071-32.768KHZ-6-T](#) [R38-32.768-12.5-5PPM-NPB](#) [BTD1062E05A-513](#) [21U15A-21.4MHZ](#) [RTX-781DF1-S-20.950](#) [LFX TAL066198Cutt](#) [9C-14.31818MBBK-T](#) [A-11.000MHZ-27](#) [ABL-27.000MHZ-B4Y-T](#) [ABM11-132-24.000MHZ-T3](#) [ABM3B1-25.000MHZ-D2Y-T](#) [SPT2A-.032768B](#) [SPT2A.032768G](#) [SSPT7F-9PF20-R](#) [LFX TAL065253Cutt](#) [LFX TAL066431Cutt](#) [XT9S20ANA14M7456](#) [XT9SNLANA16M](#) [7A-24.576MBBK-T](#) [7B-30.000MBBK-T](#) [MMCC2R32.7680KHZ](#) [7A-14.31818MBBK-T](#) [6504-202-1501](#) [6526-202-1501](#) [ABLS-12.000MHZ-B2Y-T](#) [7A-10.000MBBK-T](#) [SG636PCE-20.000MC](#) [3404](#) [E1SAA18-25.000M TR](#) [CM315D32768EZFT](#) [C1E-24.000-7-2020-R](#) [C1E-19.200-12-1530-X-R](#) [C1E-16.000-12-1530-X-R](#) [ABM11-16.000MHZ-9-B1U-T](#) [FL5000014](#) [EUCA18-3.1872M](#) [FX0800015](#) [425F35E027M0000](#) [FP0800018](#)