



THINKING ELECTRONIC INDUSTRIAL CO., LTD.

HEAD OFFICE: 12F, No.93, Dashun 1st Rd., Zuoying Dist., Kaohsiung, Taiwan
TEL: 886-7-5577660 FAX: 886-7-5570560

MANUFACTURING SITE

- KAOHSIUNG FACTORY 1: No. 51, Kaifa Rd., N.E.P.Z, Kaohsiung City 81170, Taiwan
TEL: 886-7-9616668 FAX: 886-7-9616698
- KAOHSIUNG FACTORY 2: No. 2-2, Xinjian S. Rd., N.E.P.Z., Kaohsiung City 81170, Taiwan
TEL: 886-7-9630001 FAX: 886-7-3635113
- CHANGZHOU FACTORY: No.6 Longmen Rd., Wujin High & New-Tech Industrial
Development Zone, Changzhou, Jiangsu, China 213161
TEL: 86-519-86578999 FAX: 86-519-86558643
- DONG GUAN FACTORY: No.45, East Rd., Sha-Tao Dist., Chang-An Town,
Dongguan City, Guangdong, China 523863
TEL: 86-769-85542016 FAX: 86-769-85546890
- YICHANG FACTORY: No. 283 Xiaoting Avenue, Xiaoting Dist., Yichang
City 443007, Hubei, China
TEL: 86-717-6510010 FAX: 86-717-6511430



SPECIFICATION FOR APPROVAL

CUSTOMER	立創電子
CERTIFIED MODEL/TYPE	SMAJ6.0
PART NO.	SMAJ6.0CA (RoHS+HF)
APPLICATION	
CUSTOMER P/N	
ISSUE DATE	Dec.12,2020
REV. NO.	
REV. DATE	

FOR CUSTOMER APPROVAL	CHECKED BY
	<i>Dan Zhang</i>
	APPROVED BY
	<i>Huaifang Zhang</i>





REVISED RECORD SHEET

REV. NO	REV. DATE	REVISED CONTENT



INDEX	Page
■ Part Number Code	1
■ Structure and Dimensions	2
■ Electrical Characteristics	3 ~ 4
■ Reliability	5
■ Soldering Recommendation	6
■ Packaging	7
■ Pulse Waveform	8
■ Pulse Derating Curve	8
■ Peak Pulse Power Rating Curve	9
■ Steady State Power Derating Curve	10
■ Typical Junction Capacitance	11
■ RoHS Compliant Declaration	12
■ Warehouse Storage Conditions of Products	12
■ Safety Approvals & Certificates & Test Report	13

Part Number Code

Example :

SMAJ **6.0** **CA**
 (1) (2) (3)

No.	Item	Digit	Specification
(1)	Product Type	SMAJ	Thinking Power TVS SMD Type
(2)	Reverse Stand off Voltage (V_{RWM})	6.0	6.0=6 V_{RWM}
(3)	Type Code	CA	Bi-directional 5% VBR Voltage Tolerance

Structure and Dimensions

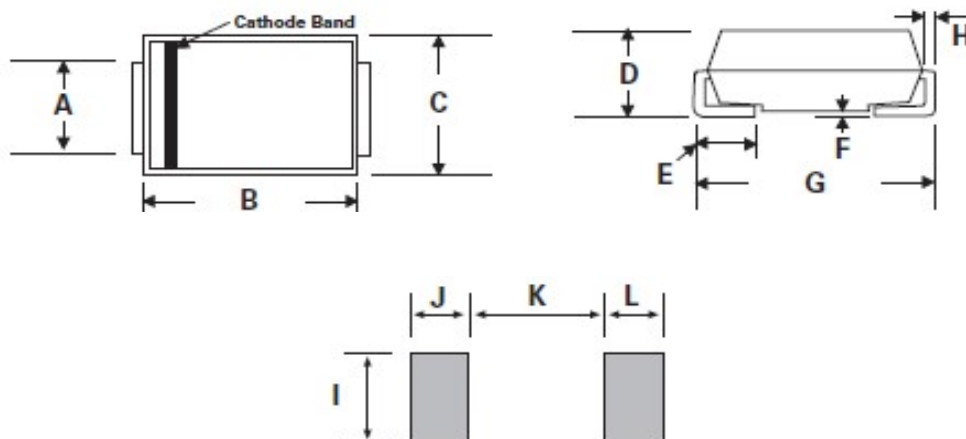

* The Cathode bend for Uni-directional product only.

Item	Millimeters		Inches	
	Min.	Max.	Min.	Max.
A	1.25	1.65	0.049	0.065
B	3.99	4.6	0.157	0.181
C	2.4	2.8	0.094	0.11
D	1.9	2.3	0.074	0.09
E	0.76	1.52	0.03	0.06
F	-	0.203	-	0.008
G	4.8	5.28	0.188	0.208
H	0.152	0.305	0.006	0.012
I	1.8	-	0.07	-
J/L	2.1	-	0.082	-
K	-	2.3	-	0.09

Electrical Characteristics

Peak power dissipation with a 10/1000 μ s waveform : 400W

Operating junction and storage temperature range : -55~+150 °C

Part No. (Uni)	Part No. (Bi)	Reverse Stand off Voltage	Breakage Voltage VBR @ IT		Test Current	Maximum Clamping Voltage VC @ Ipp	Maximum Peak Pulse Current	Maximum Reverse Leakage IR @VRWM	Marking Code	
			VRWM (V)	Min(V)					Max(V)	IT(mA)
SMAJ5.0A	SMAJ5.0CA	5	6.4	7	10	9.2	43.5	800	AE.	WE.
SMAJ6.0A	SMAJ6.0CA	6	6.67	7.37	10	10.3	38.8	800	AG.	WG.
SMAJ6.5A	SMAJ6.5CA	6.5	7.22	7.98	10	11.2	35.7	500	AK.	WK.
SMAJ7.0A	SMAJ7.0CA	7	7.78	8.6	10	12	33.3	200	AM.	WM.
SMAJ7.5A	SMAJ7.5CA	7.5	8.33	9.21	1	12.9	31	100	AP.	WP.
SMAJ8.0A	SMAJ8.0CA	8	8.89	9.83	1	13.6	29.4	50	AR.	WR.
SMAJ8.5A	SMAJ8.5CA	8.5	9.44	10.4	1	14.4	27.8	20	AT.	WT.
SMAJ9.0A	SMAJ9.0CA	9	10	11.1	1	15.4	26	10	AV.	WV.
SMAJ10A	SMAJ10CA	10	11.1	12.3	1	17	23.5	5	AX.	WX.
SMAJ11A	SMAJ11CA	11	12.2	13.5	1	18.2	22	1	AZ.	WZ.
SMAJ12A	SMAJ12CA	12	13.3	14.7	1	19.9	20.1	1	BE.	XE.
SMAJ13A	SMAJ13CA	13	14.4	15.9	1	21.5	18.6	1	BG.	XG.
SMAJ14A	SMAJ14CA	14	15.6	17.2	1	23.2	17.2	1	BK.	XK.
SMAJ15A	SMAJ15CA	15	16.7	18.5	1	24.4	16.4	1	BM.	XM.
SMAJ16A	SMAJ16CA	16	17.8	19.7	1	26	15.4	1	BP.	XP.
SMAJ17A	SMAJ17CA	17	18.9	20.9	1	27.6	14.5	1	BR.	XR.
SMAJ18A	SMAJ18CA	18	20	22.1	1	29.2	13.7	1	BT.	XT.
SMAJ20A	SMAJ20CA	20	22.2	24.5	1	32.4	12.3	1	BV.	XV.
SMAJ22A	SMAJ22CA	22	24.4	26.9	1	35.5	11.3	1	BX.	XX.
SMAJ24A	SMAJ24CA	24	26.7	29.5	1	38.9	10.3	1	BZ.	XZ.
SMAJ26A	SMAJ26CA	26	28.9	31.9	1	42.1	9.5	1	CE.	YE.
SMAJ28A	SMAJ28CA	28	31.1	34.4	1	45.4	8.8	1	CG.	YG.
SMAJ30A	SMAJ30CA	30	33.3	36.8	1	48.4	8.3	1	CK.	YK.
SMAJ33A	SMAJ33CA	33	36.7	40.6	1	53.3	7.5	1	CM.	YM.
SMAJ36A	SMAJ36CA	36	40	44.2	1	58.1	6.9	1	CP.	YP.
SMAJ40A	SMAJ40CA	40	44.4	49.1	1	64.5	6.2	1	CR.	YR.
SMAJ43A	SMAJ43CA	43	47.8	52.8	1	69.4	5.8	1	CT.	YT.
SMAJ45A	SMAJ45CA	45	50	55.3	1	72.7	5.5	1	CV.	YV.
SMAJ48A	SMAJ48CA	48	53.3	58.9	1	77.4	5.2	1	CX.	YX.
SMAJ51A	SMAJ51CA	51	56.7	62.7	1	82.4	4.9	1	CZ.	YZ.
SMAJ54A	SMAJ54CA	54	60	66.3	1	87.1	4.6	1	RE.	ZE.
SMAJ58A	SMAJ58CA	58	64.4	71.2	1	93.6	4.3	1	RG.	ZG.
SMAJ60A	SMAJ60CA	60	66.7	73.7	1	96.8	4.1	1	RK.	ZK.

Electrical CharacteristicsPeak power dissipation with a 10/1000 μ s waveform : 400W

Operating junction and storage temperature range : -55~+150 °C

Part No. (Uni)	Part No. (Bi)	Reverse Stand off Voltage	Breakage Voltage VBR @ IT		Test Current	Maximum Clamping Voltage VC @ Ipp	Maximum Peak Pulse Current	Maximum Reverse Leakage IR @VRWM	Marking Code	
			VRWM (V)	Min(V)					Max(V)	IT(mA)
SMAJ64A	SMAJ64CA	64	71.1	78.6	1	103	3.9	1	RM.	ZM.
SMAJ70A	SMAJ70CA	70	77.8	86	1	113	3.5	1	RP.	ZP.
SMAJ75A	SMAJ75CA	75	83.3	92.1	1	121	3.3	1	RR.	ZR.
SMAJ78A	SMAJ78CA	78	86.7	95.8	1	126	3.2	1	RT.	ZT.
SMAJ85A	SMAJ85CA	85	94.4	104	1	137	2.9	1	RV.	ZV.
SMAJ90A	SMAJ90CA	90	100	111	1	146	2.7	1	RX.	ZX.
SMAJ100A	SMAJ100CA	100	111	123	1	162	2.5	1	RZ.	ZZ.
SMAJ110A	SMAJ110CA	110	122	135	1	177	2.3	1	SE.	VE.
SMAJ120A	SMAJ120CA	120	133	147	1	193	2.1	1	SG.	VG.
SMAJ130A	SMAJ130CA	130	144	159	1	209	1.9	1	SK.	VK.
SMAJ150A	SMAJ150CA	150	167	185	1	243	1.6	1	SM.	VM.
SMAJ160A	SMAJ160CA	160	178	197	1	259	1.5	1	SP.	VP.
SMAJ170A	SMAJ170CA	170	189	209	1	275	1.5	1	SR.	VR.
SMAJ180A	SMAJ180CA	180	201	222	1	292	1.4	1	ST.	VT.
SMAJ190A	SMAJ190CA	190	209	243	1	308	1.3	1	SV.	VV.
SMAJ200A	SMAJ200CA	200	224	247	1	324	1.2	1	SW.	VW.
SMAJ220A	SMAJ220CA	220	246	272	1	356	1.1	1	SX.	VX.
SMAJ250A	SMAJ250CA	250	279	309	1	405	1	1	SZ.	VZ.
SMAJ300A	SMAJ300CA	300	335	371	1	486	0.8	1	DE.	HE.
SMAJ350A	SMAJ350CA	350	391	432	1	567	0.7	1	DG.	HG.
SMAJ400A	SMAJ400CA	400	447	494	1	648	0.6	1	DK.	HK.
SMAJ440A	SMAJ440CA	440	492	543	1	713	0.6	1	DM.	HM.

Reliability

Item	Standard	Test conditions / Methods	Specifications
HTRB (High Temp. Reverse Bias Test)	MIL-STD-750D METHOD 1038.3 Method 103	Test Temp. : 150°C Duration 168 hrs with rated VRWM	Electrical properties meet Specifications
PCT (Pressure Cooker Test)	MIL-STD-19500 EAPPENDIX C	Test Temp. : 121 °C Pressure:1.2Kg Duration: 96 hrs	Electrical properties meet Specifications
TCT	MIL-STD-750D METHOD 1051.5	Test Temp. : -55°C ~+150°C 20 cycles	Electrical properties meet Specifications
Forward Surge	MIL-STD-750D METHOD 4066.3	Sine half wave 8.3mS 1 shot IFSM:20A forSMF 40A for SMA/ P4SMA & SMAF 100A for SMB/P6SMB 200A for SMC/1.5SMC For Uni-directional product only.	Electrical properties meet Specifications
Soldering Heat	MIL-STD-750D METHOD 2031.2	Test Temp. : 260°C Duration:10 sec 1cycle	Electrical properties meet Specifications

Soldering Recommendation

■ IR-reflow soldering profile

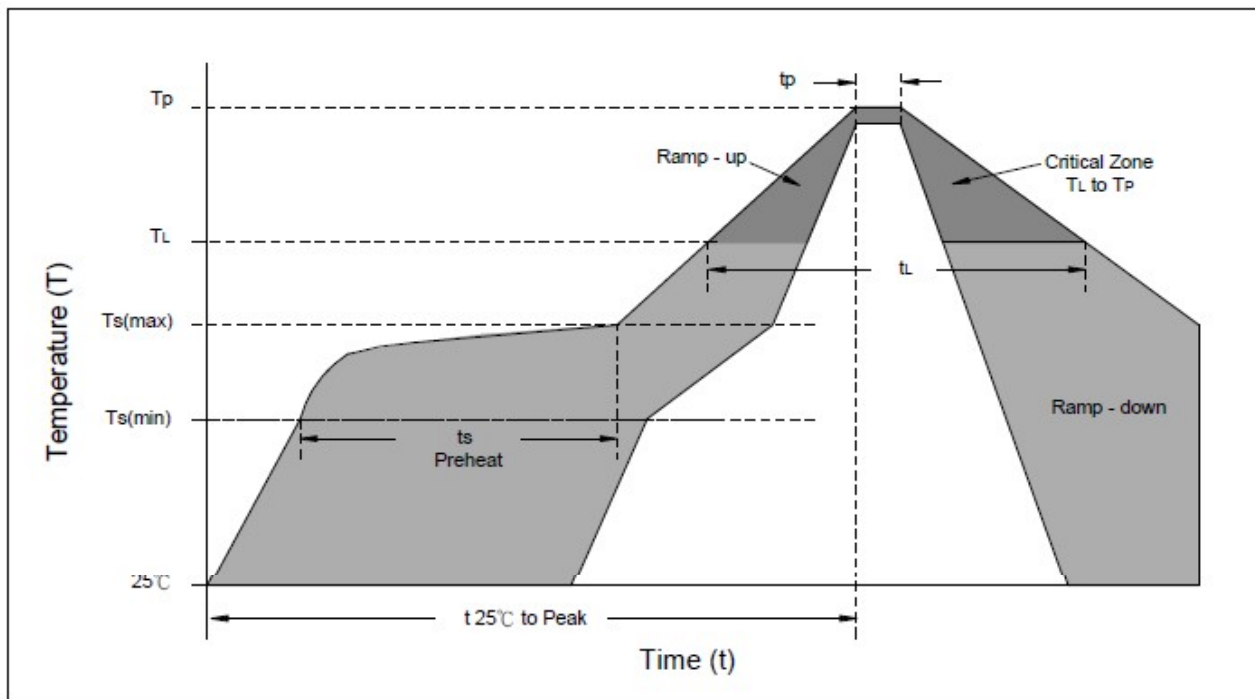

Reflow Condition	Lead-free assembly
Preheat -Temperature Min(Ts min) -Temperature Min(Ts max) -Time (min to max) (ts)	150°C 200°C 60 – 180 seconds
Average ramp up rate -Temperature Liquidus (TL) to peak	3°C/second max
Ts(max) to TL -Ramp-up Rate	3°C/second max.
Reflow -Temperature Liquidus (TL) -Time (tL)	217°C 60 – 150 seconds
Peak Temperature (TP)	260°C
Time within 5°C of actual peak Temperature(tp)	20 – 40 seconds
Ramp-down Rate	6°C/second max.
Time 25°C to peak Temperature(TP)	8 minutes max.
Do not exceed	260°C

Packaging

■ Taping Specification

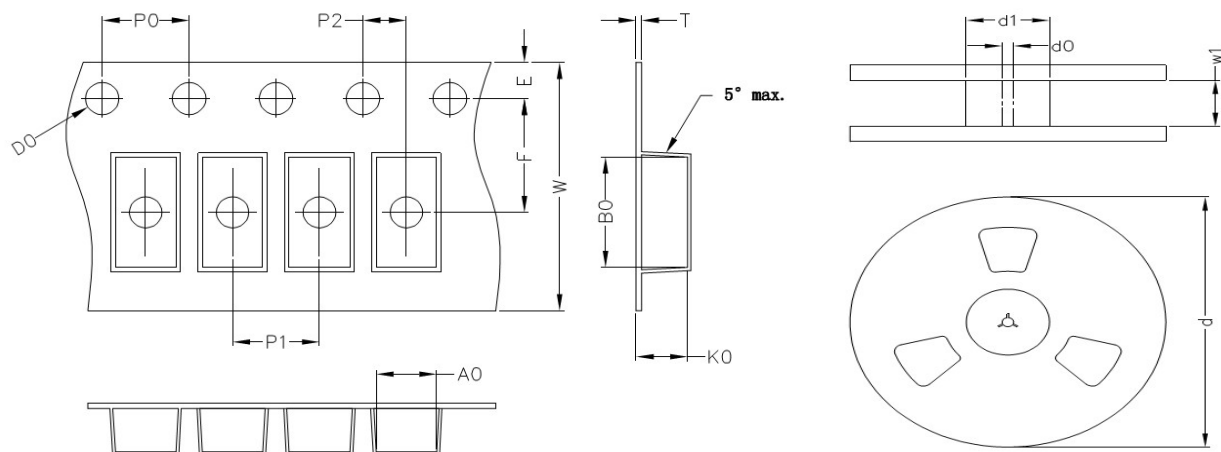

(Unit : mm)

Index	A0	B0	K0	D0	E	F	P0	P1	P2	T	W	d(13")	d1	d0	w1
SMAJ	2.8	5.33	2.36	1.55	1.75	5.5	4	4	2	0.22±0.05	12	330	75	13.5	13.5

Notes: The tolerance of carrier tape and top cover is ± 0.1 mm, the tolerance of reel is ± 2 mm

■ Quantity

Series Type	Reel size	Quantity (pcs/reel)
SMAJ	13"	5,000

Pulse Waveform

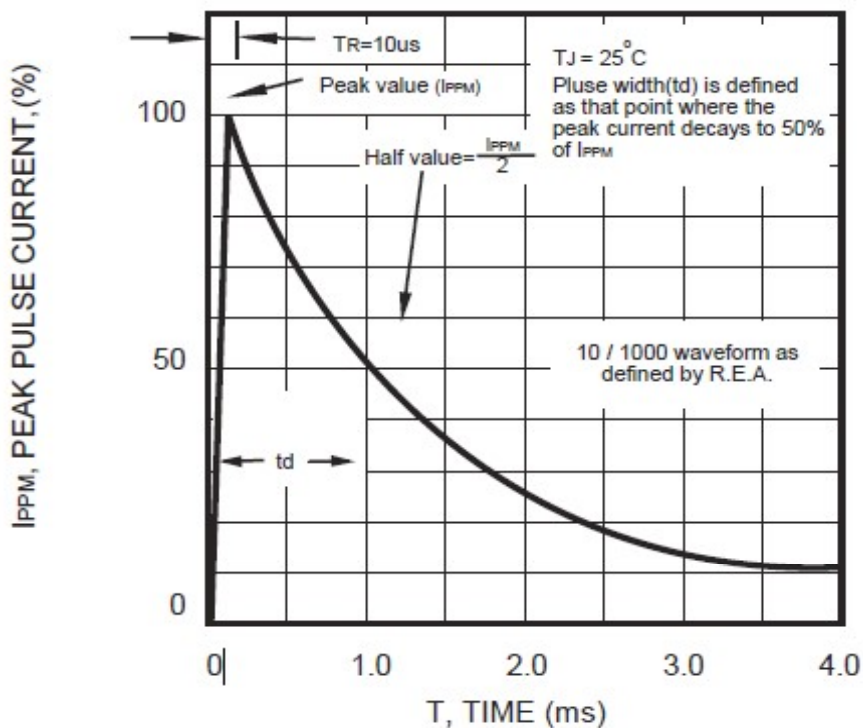

Pulse Derating Curve

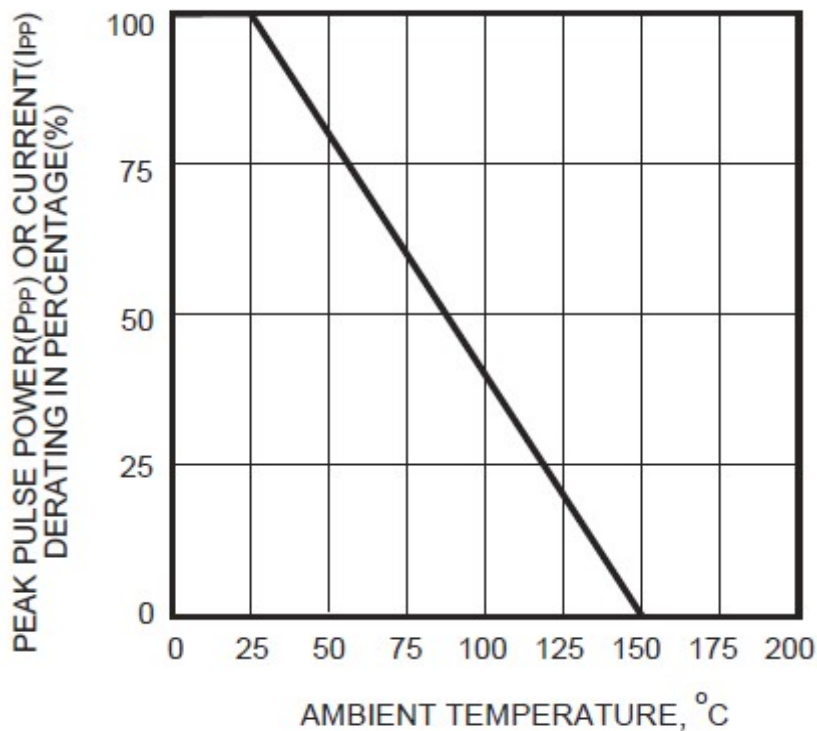

Peak Pulse Power Rating Curve

SMAJ series

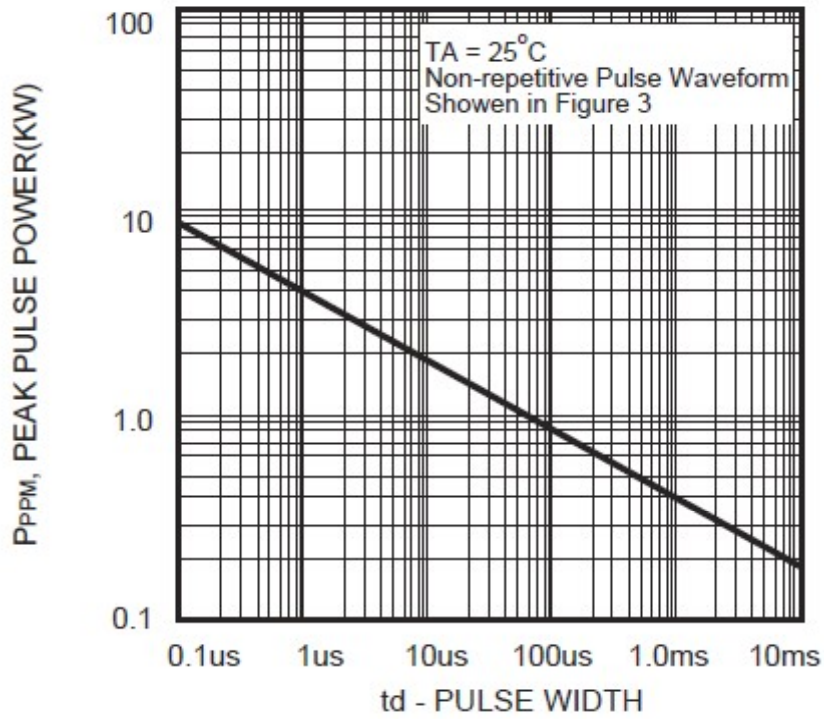

Steady State Power Derating Curve

SMAJ series

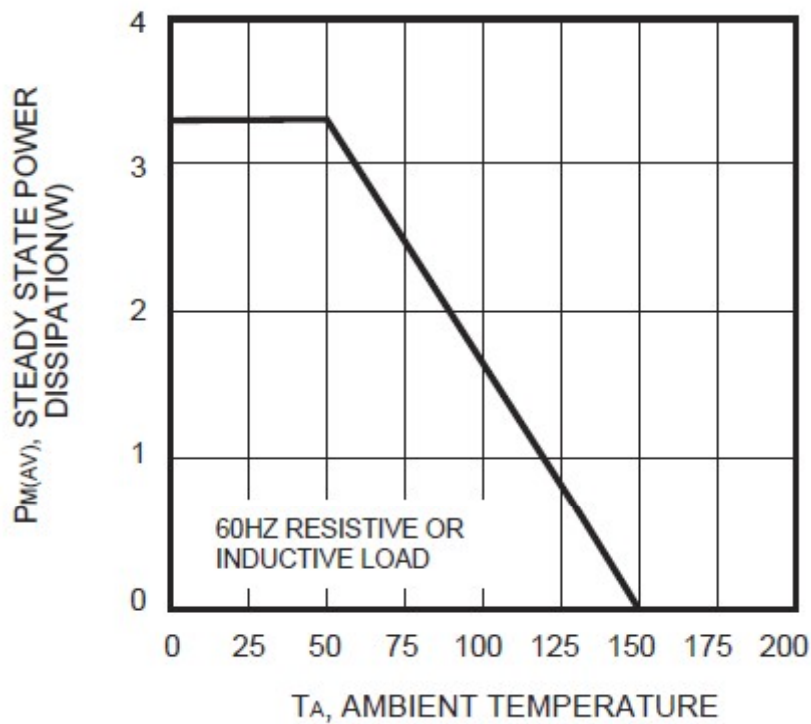

Typical Junction Capacitance

SMAJ series

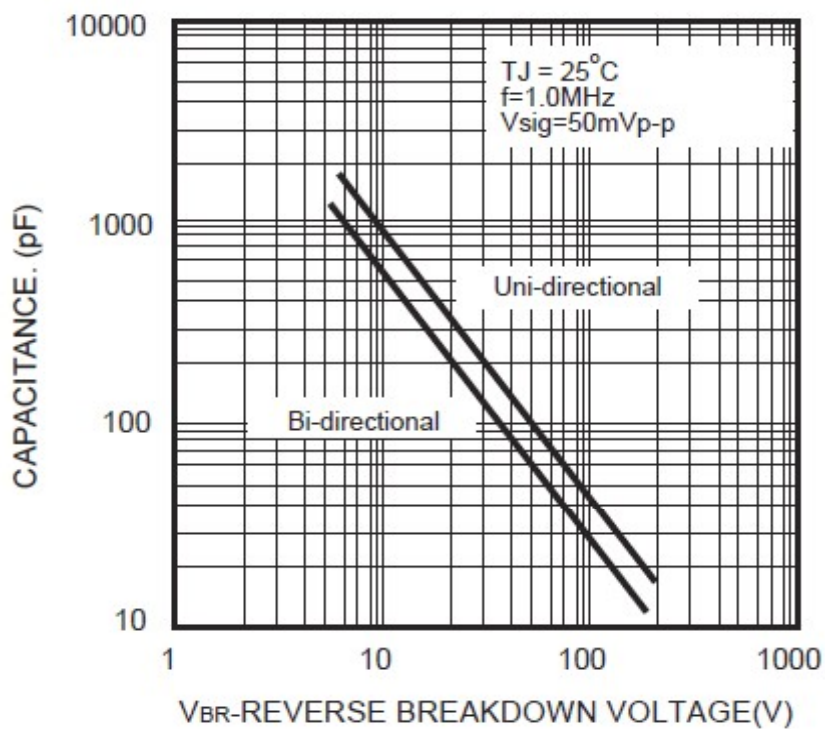

RoHS Compliant Declaration

We hereby declare that the components delivered to your company are compliant with RoHS directive 2015/863/EU.

Warehouse Storage Conditions of Products

(I) Storage Conditions :

- 1.Storage Temperature : $-10^{\circ}\text{C} \sim +40^{\circ}\text{C}$
- 2.Relative Humidity : $\leq 75\%RH$
- 3.Keep away from corrosive atmosphere and sunlight.

(II) Period of Storage : 1 year

Safety Approvals



* UL 497B recognized (File # E229991)

Certificates

- (1) IATF 16949 certificate
- (2) ISO 9001 certificate

Test Report

- (1) RoHS test report
- (2) Halogen-free test report

X-ON Electronics

Largest Supplier of Electrical and Electronic Components

Click to view similar products for [ESD Suppressors / TVS Diodes](#) category:

Click to view products by [TKS](#) manufacturer:

Other Similar products are found below :

[60KS200C](#) [D18V0L1B2LP-7B](#) [D5V0F4U5P5-7](#) [DESD5V0U1BB-7](#) [NTE4902](#) [P4KE27CA](#) [P6KE11CA](#) [P6KE39CA-TP](#) [P6KE8.2A](#)
[SA110CA](#) [SA60CA](#) [SA64CA](#) [SMBJ12CATR](#) [SMBJ33CATR](#) [SMBJ8.0A](#) [ESD101-B1-02ELS E6327](#) [ESD105-B1-02EL E6327](#) [ESD112-B1-02EL E6327](#) [ESD119B1W01005E6327XTSA1](#) [ESD5V0L1B02VH6327XTSA1](#) [ESD7451N2T5G](#) [19180-510](#) [CPDT-5V0USP-HF](#)
[3.0SMCJ33CA-F](#) [3.0SMCJ36A-F](#) [HSPC16701B02TP](#) [D3V3Q1B2DLP3-7](#) [D55V0M1B2WS-7](#) [DESD5V0U1BL-7B](#) [DRTR5V0U4SL-7](#)
[SCM1293A-04SO](#) [ESD200-B1-CSP0201 E6327](#) [SM12-7](#) [SMLJ45CA-TP](#) [CEN955 W/DATA](#) [82350120560](#) [VESD12A1A-HD1-GS08](#)
[CPDUR5V0R-HF](#) [CPDQC5V0U-HF](#) [CPDQC5V0USP-HF](#) [CPDQC5V0-HF](#) [D1213A-01LP4-7B](#) [D1213A-02WL-7](#) [MMAD1108/TR13](#)
[5KP100A](#) [5KP15A](#) [5KP18A](#) [5KP48A](#) [5KP90A](#) [5KP90CA](#)