



REVISED RECORD SHEET

REV. NO	REV. DATE	REVISED CONTENT



INDEX	Page
■ Part Number Code	1
■ Structure and Dimensions	2
■ Electrical Characteristics	3 ~ 4
■ Reliability	5
■ Soldering Recommendation	6
■ Packaging	7
■ Pulse Waveform	8
■ Pulse Derating Curve	8
■ Peak Pulse Power Rating Curve	9
■ Steady State Power Derating Curve	10
■ Typical Junction Capacitance	11
■ RoHS Compliant Declaration	12
■ Warehouse Storage Conditions of Products	12
■ Safety Approvals & Certificates & Test Report	13



Part Number Code

Example :

SMBJ **60** **CA**
(1) (2) (3)

No.	Item	Digit	Specification
(1)	Product Type	SMBJ	Thinking Power TVS SMD Type
(2)	Reverse Stand off Voltage (V_{RWM})	60	60=60 V_{RWM}
(3)	Type Code	CA	Bi-directional 5% VBR Voltage Tolerance

Structure and Dimensions

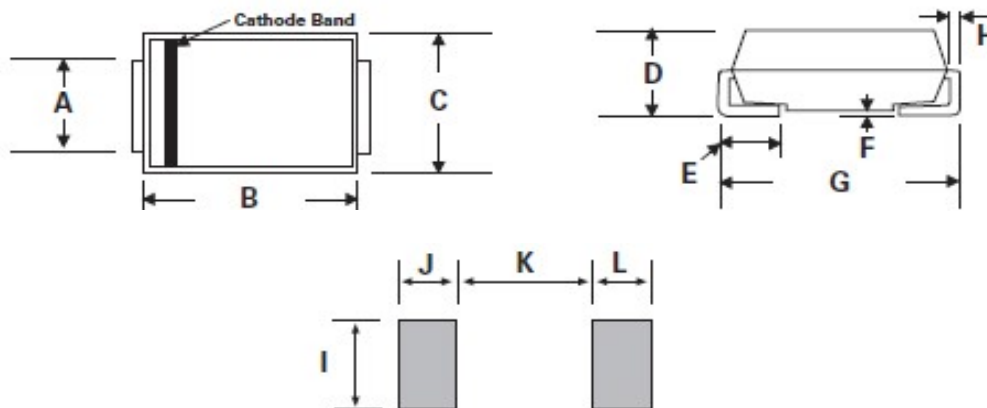

*The Cathode bend for Uni-directional product only.

Item	Millimeters		Inches	
	Min.	Max.	Min.	Max.
A	1.91	2.2	0.075	0.086
B	4.06	4.7	0.16	0.185
C	3.3	3.94	0.13	0.155
D	2.13	2.70	0.083	0.096
E	0.76	1.52	0.03	0.06
F	-	0.203	-	0.008
G	5.08	5.59	0.2	0.22
H	0.152	0.305	0.006	0.012
I	2.26	-	0.089	-
J/L	2.16	-	0.085	-
K	-	2.74	-	0.107

Electrical Characteristics

Peak power dissipation with a 10/1000 μ s waveform : 600W

Operating junction and storage temperature range : -55~+150 °C

Part No. (Uni)	Part No. (Bi)	Reverse Stand off Voltage	Breakage Voltage VBR @ IT		Test Current	Maximum Clamping Voltage VC @ Ipp	Maximum Peak Pulse Current	Maximum Reverse Leakage IR @VRWM	Marking Code	
			VRWM (V)	Min(V)					Max(V)	IT(mA)
SMBJ5.0A	SMBJ5.0CA	5	6.4	7	10	9.2	65.3	800	KE.	AE.
SMBJ6.0A	SMBJ6.0CA	6	6.67	7.37	10	10.3	58.3	800	KG.	AG.
SMBJ6.5A	SMBJ6.5CA	6.5	7.22	7.98	10	11.2	53.6	500	KK.	AK.
SMBJ7.0A	SMBJ7.0CA	7	7.78	8.6	10	12	50	200	KM.	AM.
SMBJ7.5A	SMBJ7.5CA	7.5	8.33	9.21	1	12.9	46.6	100	KP.	AP.
SMBJ8.0A	SMBJ8.0CA	8	8.89	9.83	1	13.6	44.2	50	KR.	AR.
SMBJ8.5A	SMBJ8.5CA	8.5	9.44	10.4	1	14.4	41.7	20	KT.	AT.
SMBJ9.0A	SMBJ9.0CA	9	10	11.1	1	15.4	39	10	KV.	AV.
SMBJ10A	SMBJ10CA	10	11.1	12.3	1	17	35.3	5	KX.	AX.
SMBJ11A	SMBJ11CA	11	12.2	13.5	1	18.2	33	1	KZ.	AZ.
SMBJ12A	SMBJ12CA	12	13.3	14.7	1	19.9	30.2	1	LE.	BE.
SMBJ13A	SMBJ13CA	13	14.4	15.9	1	21.5	28	1	LG.	BG.
SMBJ14A	SMBJ14CA	14	15.6	17.2	1	23.2	25.9	1	LK.	BK.
SMBJ15A	SMBJ15CA	15	16.7	18.5	1	24.4	24.6	1	LM.	BM.
SMBJ16A	SMBJ16CA	16	17.8	19.7	1	26	23.1	1	LP.	BP.
SMBJ17A	SMBJ17CA	17	18.9	20.9	1	27.6	21.8	1	LR.	BR.
SMBJ18A	SMBJ18CA	18	20	22.1	1	29.2	20.6	1	LT.	BT.
SMBJ20A	SMBJ20CA	20	22.2	24.5	1	32.4	18.6	1	LV.	BV.
SMBJ22A	SMBJ22CA	22	24.4	26.9	1	35.5	16.9	1	LX.	BX.
SMBJ24A	SMBJ24CA	24	26.7	29.5	1	38.9	15.5	1	LZ.	BZ.
SMBJ26A	SMBJ26CA	26	28.9	31.9	1	42.1	14.3	1	ME.	CE.
SMBJ28A	SMBJ28CA	28	31.1	34.4	1	45.4	13.3	1	MG.	CG.
SMBJ30A	SMBJ30CA	30	33.3	36.8	1	48.4	12.4	1	MK.	CK.
SMBJ33A	SMBJ33CA	33	36.7	40.6	1	53.3	11.3	1	MM.	CM.
SMBJ36A	SMBJ36CA	36	40	44.2	1	58.1	10.4	1	MP.	CP.
SMBJ40A	SMBJ40CA	40	44.4	49.1	1	64.5	9.3	1	MR.	CR.
SMBJ43A	SMBJ43CA	43	47.8	52.8	1	69.4	8.7	1	MT.	CT.
SMBJ45A	SMBJ45CA	45	50	55.3	1	72.7	8.3	1	MV.	CV.
SMBJ48A	SMBJ48CA	48	53.3	58.9	1	77.4	7.8	1	MX.	CX.
SMBJ51A	SMBJ51CA	51	56.7	62.7	1	82.4	7.3	1	MZ.	CZ.
SMBJ54A	SMBJ54CA	54	60	66.3	1	87.1	6.9	1	NE.	DE.
SMBJ58A	SMBJ58CA	58	64.4	71.2	1	93.6	6.5	1	NG.	DG.
SMBJ60A	SMBJ60CA	60	66.7	73.7	1	96.8	6.2	1	NK.	DK.

Electrical CharacteristicsPeak power dissipation with a 10/1000 μ s waveform : 600W

Operating junction and storage temperature range : -55~+150 °C

Part No. (Uni)	Part No. (Bi)	Reverse Stand off Voltage	Breakage Voltage VBR @ IT		Test Current	Maximum Clamping Voltage VC @ Ipp	Maximum Peak Pulse Current	Maximum Reverse Leakage IR @VRWM	Marking Code	
			VRWM (V)	Min(V)					Max(V)	IT(mA)
SMBJ64A	SMBJ64CA	64	71.1	78.6	1	103	5.9	1	NM.	DM.
SMBJ70A	SMBJ70CA	70	77.8	86	1	113	5.3	1	NP.	DP.
SMBJ75A	SMBJ75CA	75	83.3	92.1	1	121	5	1	NR.	DR.
SMBJ78A	SMBJ78CA	78	86.7	95.8	1	126	4.8	1	NT.	DT.
SMBJ85A	SMBJ85CA	85	94.4	104	1	137	4.4	1	NV.	DV.
SMBJ90A	SMBJ90CA	90	100	111	1	146	4.1	1	NX.	DX.
SMBJ100A	SMBJ100CA	100	111	123	1	162	3.7	1	NZ.	DZ.
SMBJ110A	SMBJ110CA	110	122	135	1	177	3.4	1	PE.	EE.
SMBJ120A	SMBJ120CA	120	133	147	1	193	3.1	1	PG.	EG.
SMBJ130A	SMBJ130CA	130	144	159	1	209	2.9	1	PK.	EK.
SMBJ150A	SMBJ150CA	150	167	185	1	243	2.5	1	PM.	EM.
SMBJ160A	SMBJ160CA	160	178	197	1	259	2.3	1	PP.	EP.
SMBJ170A	SMBJ170CA	170	189	209	1	275	2.2	1	PR.	ER.
SMBJ180A	SMBJ180CA	180	201	222	1	292	2.1	1	PT.	ET.
SMBJ190A	SMBJ190CA	190	209	243	1	308	2	1	PV.	EV.
SMBJ200A	SMBJ200CA	200	224	247	1	324	1.9	1	PW.	EW.
SMBJ220A	SMBJ220CA	220	246	272	1	356	1.7	1	PX.	EX.
SMBJ250A	SMBJ250CA	250	279	309	1	405	1.5	1	PZ.	EZ.
SMBJ300A	SMBJ300CA	300	335	371	1	486	1.3	1	QE.	FE.
SMBJ350A	SMBJ350CA	350	391	432	1	567	1.1	1	QG.	FG.
SMBJ400A	SMBJ400CA	400	447	494	1	648	0.9	1	QK.	FK.
SMBJ440A	SMBJ440CA	440	492	543	1	713	0.9	1	QM.	FM.

Reliability

Item	Standard	Test conditions / Methods	Specifications
HTRB (High Temp. Reverse Bias Test)	MIL-STD-750D METHOD 1038.3 Method 103	Test Temp. : 150°C Duration 168 hrs with rated VRWM	Electrical properties meet Specifications
PCT (Pressure Cooker Test)	MIL-STD-19500 EAPPENDIX C	Test Temp. : 121 °C Pressure:1.2Kg Duration: 96 hrs	Electrical properties meet Specifications
TCT	MIL-STD-750D METHOD 1051.5	Test Temp. : -55°C ~+150°C 20 cycles	Electrical properties meet Specifications
Forward Surge	MIL-STD-750D METHOD 4066.3	Sine half wave 8.3mS 1 shot IFSM:20A forSMF 40A for SMA/ P4SMA & SMAF 100A for SMB/P6SMB 200A for SMC/1.5SMC For Uni-directional product only.	Electrical properties meet Specifications
Soldering Heat	MIL-STD-750D METHOD 2031.2	Test Temp. : 260°C Duration:10 sec 1cycle	Electrical properties meet Specifications

Soldering Recommendation

■ IR-reflow soldering profile

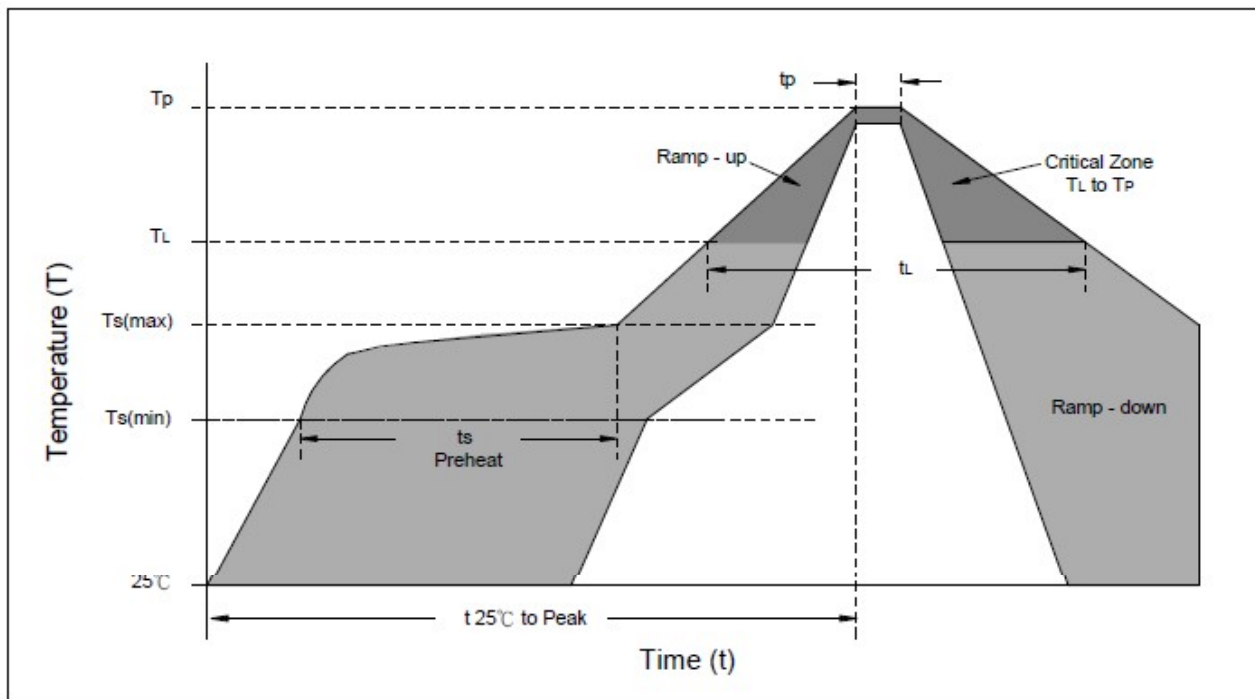

Reflow Condition	Lead-free assembly
Preheat -Temperature Min(Ts min) -Temperature Min(Ts max) -Time (min to max) (ts)	150°C 200°C 60 – 180 seconds
Average ramp up rate -Temperature Liquidus (TL) to peak	3°C/second max
Ts(max) to TL -Ramp-up Rate	3°C/second max.
Reflow -Temperature Liquidus (TL) -Time (tl)	217°C 60 – 150 seconds
Peak Temperature (TP)	260°C
Time within 5°C of actual peak Temperature(tp)	20 – 40 seconds
Ramp-down Rate	6°C/second max.
Time 25°C to peak Temperature(TP)	8 minutes max.
Do not exceed	260°C

Packaging

■ Taping Specification

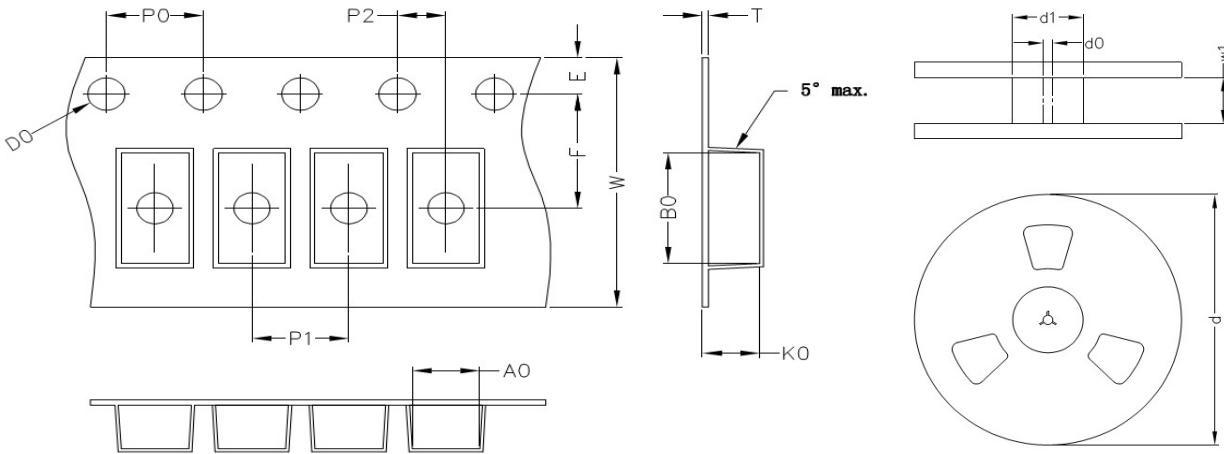

(Unit : mm)

Index	A0	B0	K0	D0	E	F	P0	P1	P2	T	W	d(13")	d1	d0	w1
SMBJ	3.65±0.1	5.6±0.1	2.57±0.1	1.55	1.75	5.5	4	8	2	0.25	12	330	75	13.5	13.5

Notes: The tolerance of carrier tape and top cover is ±0.1mm, the tolerance of reel is ±2mm

■ Quantity

Series Type	Reel size	Quantity (pcs/reel)
SMBJ	13"	3,000

Pulse Waveform

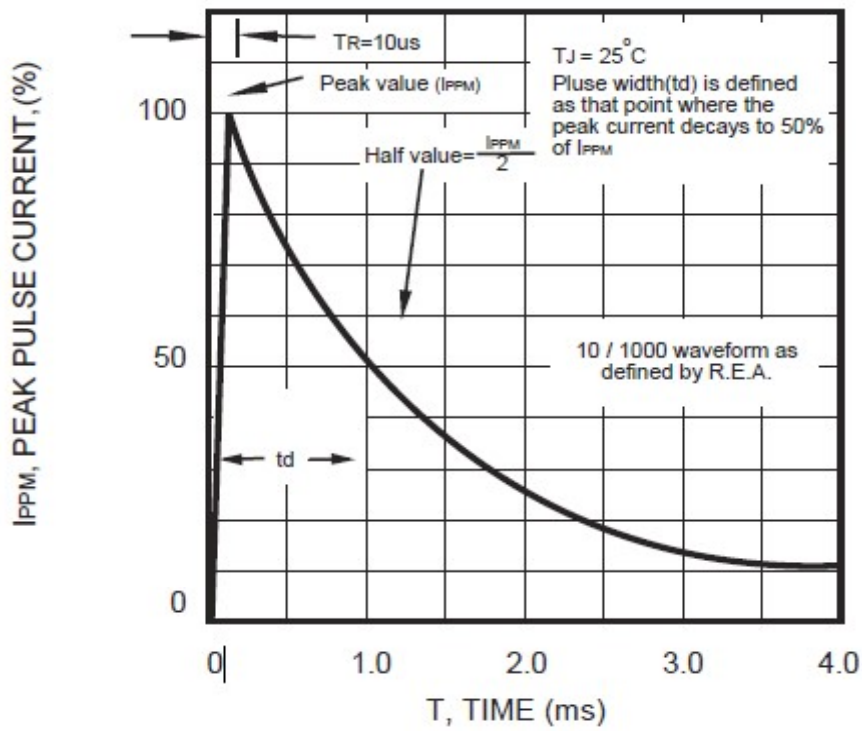

Pulse Derating Curve

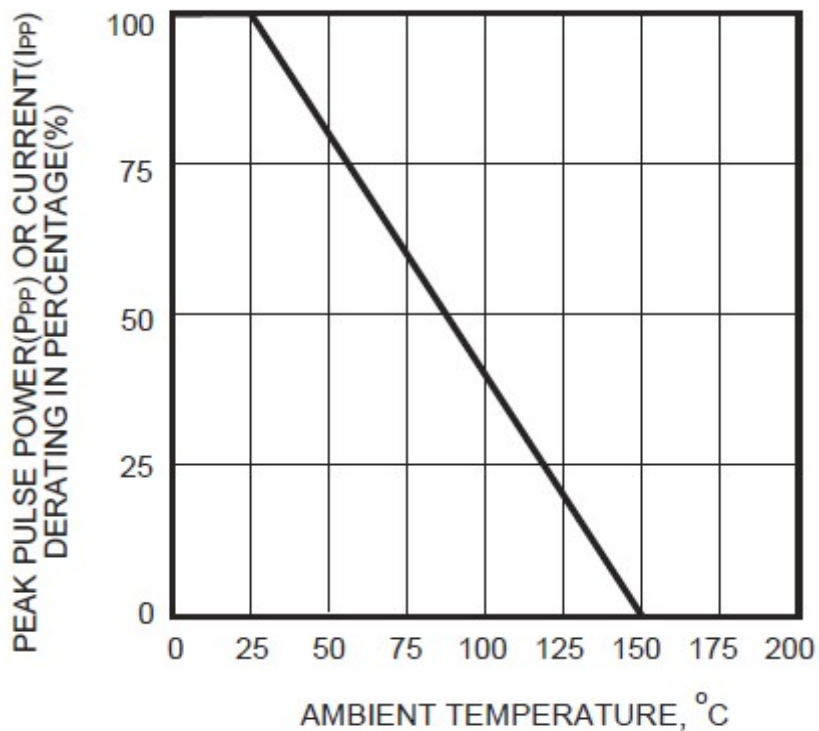

Peak Pulse Power Rating Curve

SMBJ series

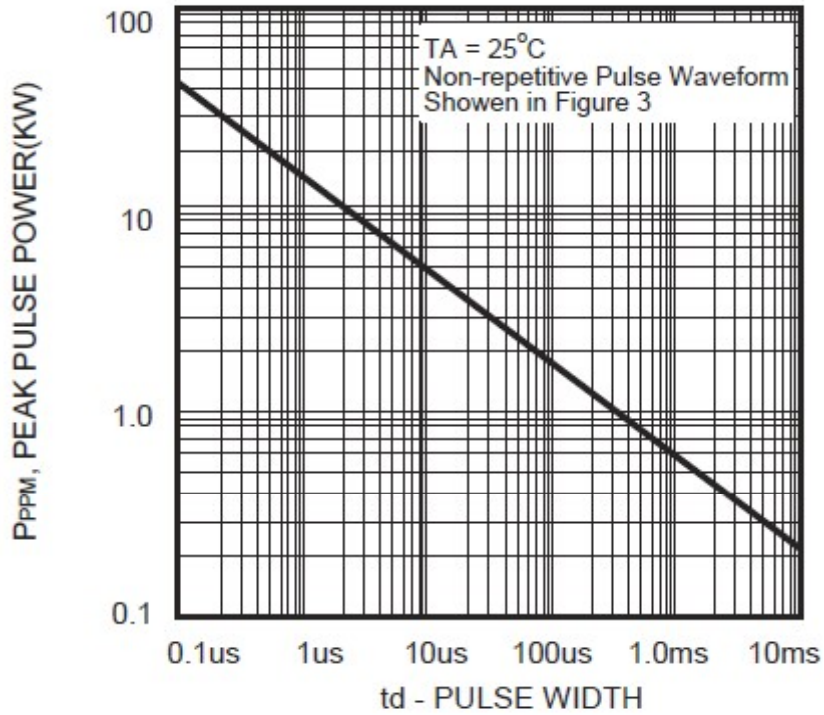

Steady State Power Derating Curve

SMBJ series

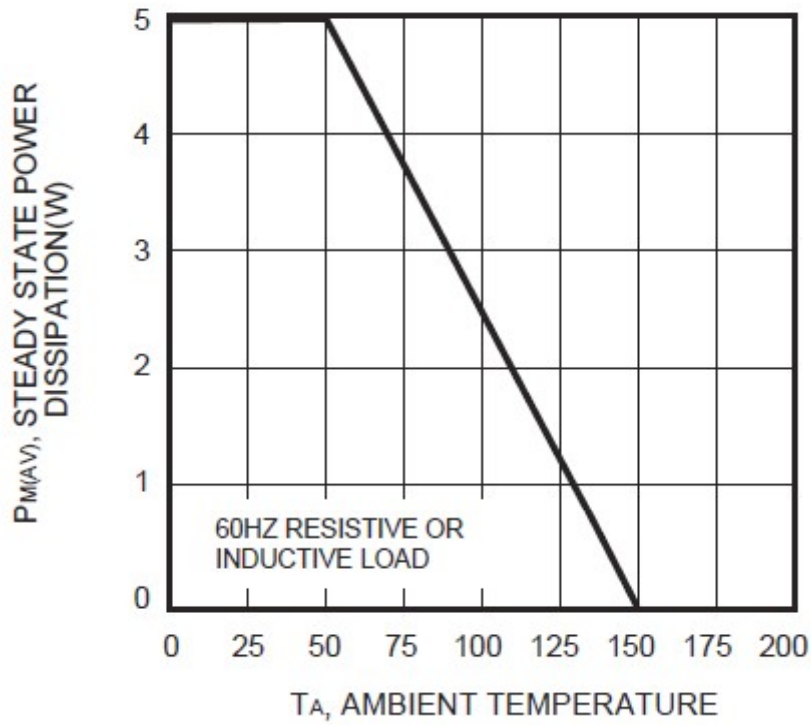

Typical Junction Capacitance

SMBJ series

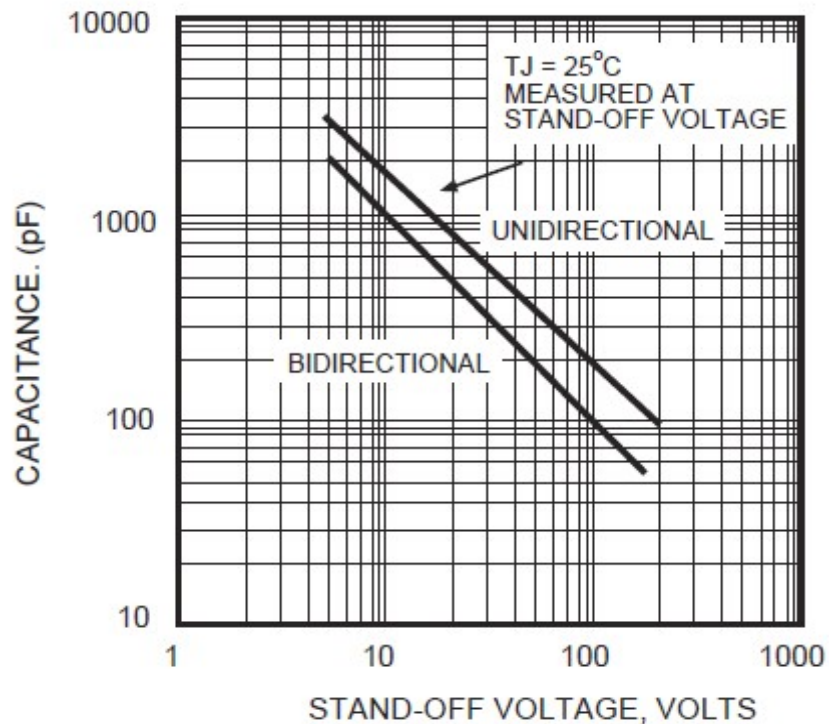

RoHS Compliant Declaration

We hereby declare that the components delivered to your company are compliant with RoHS directive 2015/863/EU.

Warehouse Storage Conditions of Products

(I) Storage Conditions :

- 1.Storage Temperature : $-10^{\circ}\text{C} \sim +40^{\circ}\text{C}$
- 2.Relative Humidity : $\leq 75\%RH$
- 3.Keep away from corrosive atmosphere and sunlight.

(II) Period of Storage : 1 year

Safety Approvals



* UL 497B recognized (File # E229991)

Certificates

- (1) IATF 16949 certificate
- (2) ISO 9001 certificate

Test Report

- (1) RoHS test report
- (2) Halogen-free test report

X-ON Electronics

Largest Supplier of Electrical and Electronic Components

Click to view similar products for [ESD Suppressors / TVS Diodes](#) category:

Click to view products by [TKS](#) manufacturer:

Other Similar products are found below :

[60KS200C](#) [D18V0L1B2LP-7B](#) [D5V0F4U5P5-7](#) [DESD5V0U1BB-7](#) [NTE4902](#) [P4KE27CA](#) [P6KE11CA](#) [P6KE39CA-TP](#) [P6KE8.2A](#)
[SA110CA](#) [SA60CA](#) [SA64CA](#) [SMBJ12CATR](#) [SMBJ33CATR](#) [SMBJ8.0A](#) [ESD101-B1-02ELS E6327](#) [ESD105-B1-02EL E6327](#) [ESD112-B1-02EL E6327](#) [ESD119B1W01005E6327XTSA1](#) [ESD5V0L1B02VH6327XTSA1](#) [ESD7451N2T5G](#) [19180-510](#) [CPDT-5V0USP-HF](#)
[3.0SMCJ33CA-F](#) [3.0SMCJ36A-F](#) [HSPC16701B02TP](#) [D3V3Q1B2DLP3-7](#) [D55V0M1B2WS-7](#) [DESD5V0U1BL-7B](#) [DRTR5V0U4SL-7](#)
[SCM1293A-04SO](#) [ESD200-B1-CSP0201 E6327](#) [SM12-7](#) [SMF8.0A-TP](#) [SMLJ45CA-TP](#) [CEN955 W/DATA](#) [82350120560](#) [VESD12A1A-](#)
[HD1-GS08](#) [CPDUR5V0R-HF](#) [CPDQC5V0U-HF](#) [CPDQC5V0USP-HF](#) [CPDQC5V0-HF](#) [D1213A-01LP4-7B](#) [D1213A-02WL-7](#)
[1SMB33CAT3G-XYZ](#) [MMAD1108/TR13](#) [5KP100A](#) [5KP15A](#) [5KP18A](#) [5KP48A](#)