

THINKING ELECTRONIC INDUSTRIAL CO., LTD.

HEAD OFFICE: 12F, No.93, Dashun 1st Rd., Zuoying Dist., Kaohsiung, Taiwan
 TEL: 886-7-5577660 FAX: 886-7-5570560

MANUFACTURING SITE

- KAOHSIUNG FACTORY 1: No. 51, Kaifa Rd., N.E.P.Z, Kaohsiung City 81170, Taiwan
 TEL: 886-7-9616668 FAX: 886-7-9616698
- KAOHSIUNG FACTORY 2: No. 2-2, Xinjian S. Rd., N.E.P.Z., Kaohsiung City 81170, Taiwan
 TEL: 886-7-9630001 FAX: 886-7-3635113
- CHANGZHOU FACTORY: No.6 Longmen Rd., Wujin High & New-Tech Industrial
 Development Zone, Changzhou, Jiangsu, China 213161
 TEL:86-519-86578999 FAX:86-519-86558643
- DONG GUAN FACTORY: No.45, East Rd., Sha-Tao Dist., Chang-An Town,
 Dongguan City, Guangdong, China 523863
 TEL:86-769-85542016 FAX:86-769-85546890
- YICHANG FACTORY: No. 283 Xiaoting Avenue, Xiaoting Dist., Yichang
 City 443007, Hubei, China
 TEL:86-717-6510010 FAX:86-717-6511430



SPECIFICATION FOR APPROVAL

CUSTOMER	立創電子
CERTIFIED MODEL/TYPE	SMCJ75
PART NO.	SMCJ75CA (RoHS+HF)
APPLICATION	
CUSTOMER P/N	
ISSUE DATE	Jan.18,2021
REV. NO.	
REV. DATE	

FOR CUSTOMER APPROVAL	CHECKED BY
	<i>Dan Zhang</i>
	APPROVED BY
	<i>Huaifang Zhang</i>





REVISED RECORD SHEET

REV. NO	REV. DATE	REVISED CONTENT



INDEX	Page
■ Part Number Code	1
■ Structure and Dimensions	2
■ Electrical Characteristics	3 ~ 4
■ Reliability	5
■ Soldering Recommendation	6
■ Packaging	7
■ Pulse Waveform	8
■ Pulse Derating Curve	8
■ Peak Pulse Power Rating Curve	9
■ Steady State Power Derating Curve	10
■ Typical Junction Capacitance	11
■ RoHS Compliant Declaration	12
■ Warehouse Storage Conditions of Products	12
■ Safety Approvals & Certificates & Test Report	13



Part Number Code

Example :

SMCJ **75** **CA**
(1) (2) (3)

No.	Item	Digit	Specification
(1)	Product Type	SMCJ	Thinking Power TVS SMD Type
(2)	Reverse Stand off Voltage (V_{RWM})	75	75=75 V_{RWM}
(3)	Type Code	CA	Bi-directional 5% VBR Voltage Tolerance

Structure and Dimensions

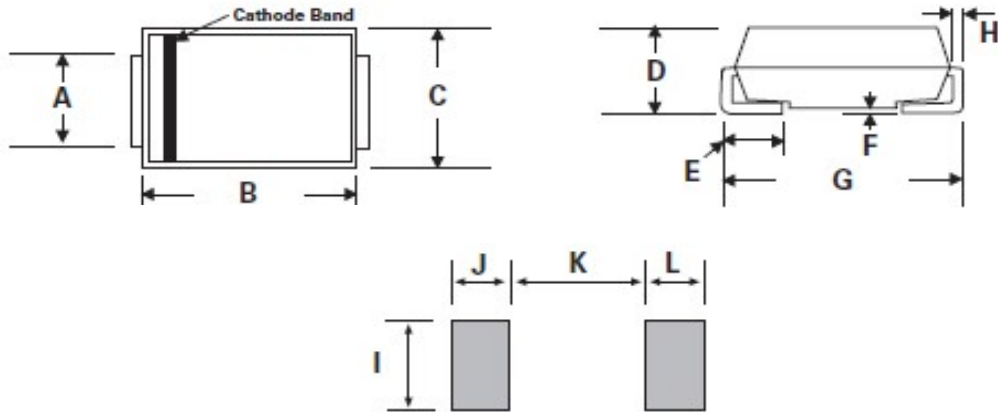

*The Cathode bend for Uni-directional product only.

Item	Millimeters		Inches	
	Min.	Max.	Min.	Max.
A	2.75	3.25	0.108	0.128
B	6.6	7.11	0.26	0.28
C	5.59	6.22	0.22	0.245
D	2	2.62	0.079	0.103
E	0.76	1.52	0.03	0.06
F	-	0.203	-	0.008
G	7.75	8.13	0.305	0.32
H	0.152	0.305	0.006	0.012
I	3.3	-	0.129	-
J/L	2.4	-	0.094	-
K	-	4.2	-	0.165

Electrical Characteristics

Peak power dissipation with a 10/1000 μ s waveform : 1500W

Operating junction and storage temperature range : -55~+150 °C

Part No. (Uni)	Part No. (Bi)	Reverse Stand off Voltage	Breakage Voltage VBR @ IT		Test Current	Maximum Clamping Voltage VC @ Ipp	Maximum Peak Pulse Current	Maximum Reverse Leakage IR @VRWM	Marking Code	
			VRWM (V)	Min(V)					Max(V)	IT(mA)
SMCJ5.0A	SMCJ5.0CA	5	6.4	7	10	9.2	163	800	GDE.	BDE.
SMCJ6.0A	SMCJ6.0CA	6	6.67	7.37	10	10.3	145.7	800	GDG.	BDG.
SMCJ6.5A	SMCJ6.5CA	6.5	7.22	7.98	10	11.2	134	500	GDK.	BDK.
SMCJ7.0A	SMCJ7.0CA	7	7.78	8.6	10	12	125	200	GDM.	BDM.
SMCJ7.5A	SMCJ7.5CA	7.5	8.33	9.21	1	12.9	116.3	100	GDP.	BDP.
SMCJ8.0A	SMCJ8.0CA	8	8.89	9.83	1	13.6	110.3	50	GDR.	BDR.
SMCJ8.5A	SMCJ8.5CA	8.5	9.44	10.4	1	14.4	104.2	20	GDT.	BDT.
SMCJ9.0A	SMCJ9.0CA	9	10	11.1	1	15.4	97.4	10	GDV.	BDV.
SMCJ10A	SMCJ10CA	10	11.1	12.3	1	17	88.3	5	GDX.	BDX.
SMCJ11A	SMCJ11CA	11	12.2	13.5	1	18.2	82.5	1	GDZ.	BDZ.
SMCJ12A	SMCJ12CA	12	13.3	14.7	1	19.9	75.4	1	GEE.	BEE.
SMCJ13A	SMCJ13CA	13	14.4	15.9	1	21.5	69.8	1	GEG.	BEG.
SMCJ14A	SMCJ14CA	14	15.6	17.2	1	23.2	64.7	1	GEK.	BEK.
SMCJ15A	SMCJ15CA	15	16.7	18.5	1	24.4	61.5	1	GEM.	BEM.
SMCJ16A	SMCJ16CA	16	17.8	19.7	1	26	57.7	1	GEP.	BEP.
SMCJ17A	SMCJ17CA	17	18.9	20.9	1	27.6	54.4	1	GER.	BER.
SMCJ18A	SMCJ18CA	18	20	22.1	1	29.2	51.4	1	GET.	BET.
SMCJ20A	SMCJ20CA	20	22.2	24.5	1	32.4	46.3	1	GEV.	BEV.
SMCJ22A	SMCJ22CA	22	24.4	26.9	1	35.5	42.3	1	GEX.	BEX.
SMCJ24A	SMCJ24CA	24	26.7	29.5	1	38.9	38.6	1	GEZ.	BEZ.
SMCJ26A	SMCJ26CA	26	28.9	31.9	1	42.1	35.7	1	GFE.	BFE.
SMCJ28A	SMCJ28CA	28	31.1	34.4	1	45.4	33.1	1	GFG.	BFG.
SMCJ30A	SMCJ30CA	30	33.3	36.8	1	48.4	31	1	GFK.	BFK.
SMCJ33A	SMCJ33CA	33	36.7	40.6	1	53.3	28.2	1	GFM.	BFM.
SMCJ36A	SMCJ36CA	36	40	44.2	1	58.1	25.9	1	GFP.	BFP.
SMCJ40A	SMCJ40CA	40	44.4	49.1	1	64.5	23.3	1	GFR.	BFR.
SMCJ43A	SMCJ43CA	43	47.8	52.8	1	69.4	21.7	1	GFT.	BFT.
SMCJ45A	SMCJ45CA	45	50	55.3	1	72.7	20.6	1	GFV.	BFV.
SMCJ48A	SMCJ48CA	48	53.3	58.9	1	77.4	19.4	1	GFX.	BFX.
SMCJ51A	SMCJ51CA	51	56.7	62.7	1	82.4	18.2	1	GFZ.	BFZ.
SMCJ54A	SMCJ54CA	54	60	66.3	1	87.1	17.3	1	GGE.	BGE.
SMCJ58A	SMCJ58CA	58	64.4	71.2	1	93.6	16.1	1	GGG.	BGG.
SMCJ60A	SMCJ60CA	60	66.7	73.7	1	96.8	15.5	1	G GK.	B GK.

Electrical CharacteristicsPeak power dissipation with a 10/1000 μ s waveform : 1500W

Operating junction and storage temperature range : -55~+150 °C

Part No. (Uni)	Part No. (Bi)	Reverse Stand off Voltage	Breakage Voltage VBR @ IT		Test Current	Maximum Clamping Voltage VC @ Ipp	Maximum Peak Pulse Current	Maximum Reverse Leakage IR @VRWM	Marking Code	
			VRWM (V)	Min(V)					Max(V)	IT(mA)
SMCJ64A	SMCJ64CA	64	71.1	78.6	1	103	14.6	1	GGM.	BGM.
SMCJ70A	SMCJ70CA	70	77.8	86	1	113	13.3	1	GGP.	BGP.
SMCJ75A	SMCJ75CA	75	83.3	92.1	1	121	12.4	1	GGR.	BGR.
SMCJ78A	SMCJ78CA	78	86.7	95.8	1	126	11.9	1	GGT.	BGT.
SMCJ85A	SMCJ85CA	85	94.4	104	1	137	11	1	GGV.	BGV.
SMCJ90A	SMCJ90CA	90	100	111	1	146	10.3	1	GGX.	BGX.
SMCJ100A	SMCJ100CA	100	111	123	1	162	9.3	1	GGZ.	BGZ.
SMCJ110A	SMCJ110CA	110	122	135	1	177	8.5	1	GHE.	BHE.
SMCJ120A	SMCJ120CA	120	133	147	1	193	7.8	1	GHG.	BHG.
SMCJ130A	SMCJ130CA	130	144	159	1	209	7.2	1	GHK.	BHK.
SMCJ150A	SMCJ150CA	150	167	185	1	243	6.2	1	GHM.	BHM.
SMCJ160A	SMCJ160CA	160	178	197	1	259	5.8	1	GHP.	BHP.
SMCJ170A	SMCJ170CA	170	189	209	1	275	5.5	1	GHR.	BHR.
SMCJ180A	SMCJ180CA	180	201	222	1	292	5.1	1	GHT.	BHT.
SMCJ190A	SMCJ190CA	190	209	243	1	308	4.8	1	GHV.	BHV.
SMCJ200A	SMCJ200CA	200	224	247	1	324	4.6	1	GHW.	BHW.
SMCJ220A	SMCJ220CA	220	246	272	1	356	4.2	1	GHX.	BHX.
SMCJ250A	SMCJ250CA	250	279	309	1	405	3.7	1	GHZ.	BHZ.
SMCJ300A	SMCJ300CA	300	335	371	1	486	3.1	1	GJE.	BJE.
SMCJ350A	SMCJ350CA	350	391	432	1	567	2.6	1	GJG.	BJG.
SMCJ400A	SMCJ400CA	400	447	494	1	648	2.3	1	GJK.	BJK.
SMCJ440A	SMCJ440CA	440	492	543	1	713	2.1	1	GJM.	BJM.

Reliability

Item	Standard	Test conditions / Methods	Specifications
HTRB (High Temp. Reverse Bias Test)	MIL-STD-750D METHOD 1038.3 Method 103	Test Temp. : 150°C Duration 168 hrs with rated VRWM	Electrical properties meet Specifications
PCT (Pressure Cooker Test)	MIL-STD-19500 EAPPENDIX C	Test Temp. : 121 °C Pressure:1.2Kg Duration: 96 hrs	Electrical properties meet Specifications
TCT	MIL-STD-750D METHOD 1051.5	Test Temp. : -55°C ~+150°C 20 cycles	Electrical properties meet Specifications
Forward Surge	MIL-STD-750D METHOD 4066.3	Sine half wave 8.3mS 1 shot IFSM:20A forSMF 40A for SMA/ P4SMA & SMAF 100A for SMB/P6SMB 200A for SMC/1.5SMC For Uni-directional product only.	Electrical properties meet Specifications
Soldering Heat	MIL-STD-750D METHOD 2031.2	Test Temp. : 260°C Duration:10 sec 1cycle	Electrical properties meet Specifications

Soldering Recommendation

■ IR-reflow soldering profile



Reflow Condition	Lead-free assembly
Preheat -Temperature Min(Ts min) -Temperature Min(Ts max) -Time (min to max) (ts)	150°C 200°C 60 – 180 seconds
Average ramp up rate -Temperature Liquidus (TL) to peak	3°C/second max
Ts(max) to TL -Ramp-up Rate	3°C/second max.
Reflow -Temperature Liquidus (TL) -Time (tl)	217°C 60 – 150 seconds
Peak Temperature (TP)	260°C
Time within 5°C of actual peak Temperature(tp)	20 – 40 seconds
Ramp-down Rate	6°C/second max.
Time 25°C to peak Temperature(TP)	8 minutes max.
Do not exceed	260°C

Packaging

■ Taping Specification

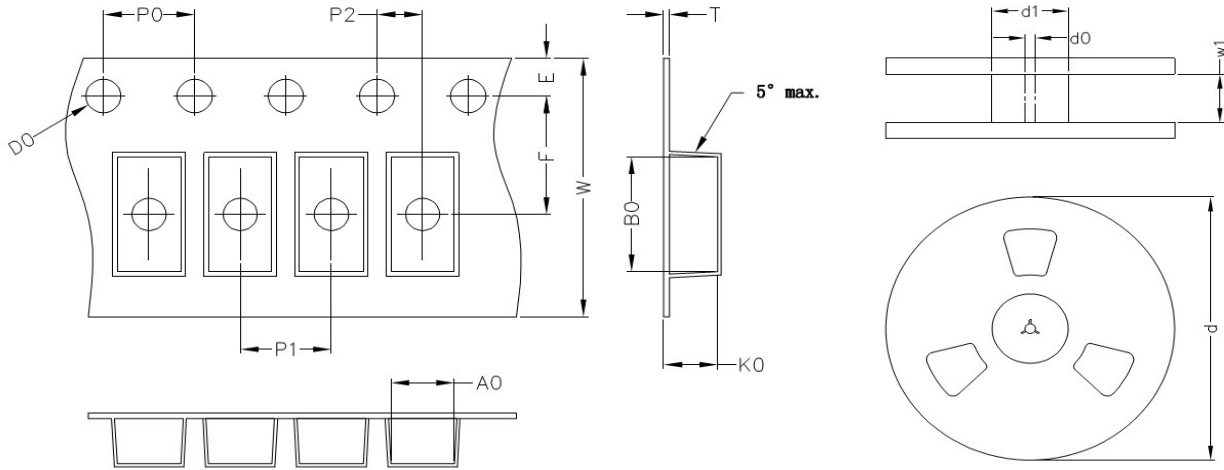

(Unit : mm)

Index	A0	B0	K0	D0	E	F	P0	P1	P2	T	W	d(13")	d1	d0	w1
SMCJ	6.05	8.31	2.54	1.55	1.75	7.5	4	8	2	0.25	16	330	75	13.5	17

Notes: The tolerance of carrier tape and top cover is ± 0.1 mm, the tolerance of reel is ± 2 mm

■ Quantity

Series Type	Reel size	Quantity (pcs/reel)
SMCJ	13"	3,000

Pulse Waveform

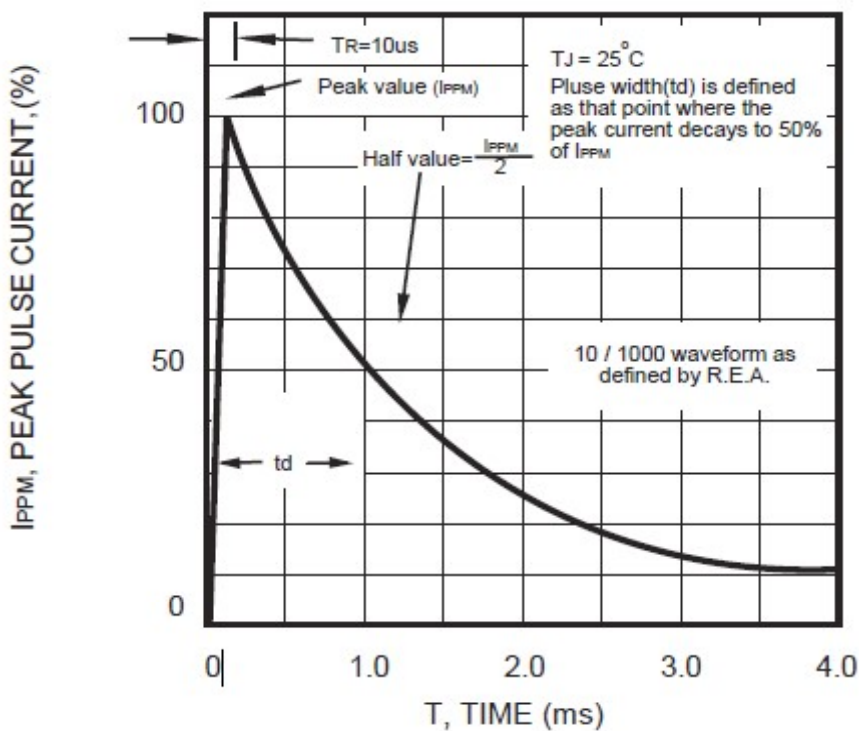

Pulse Derating Curve

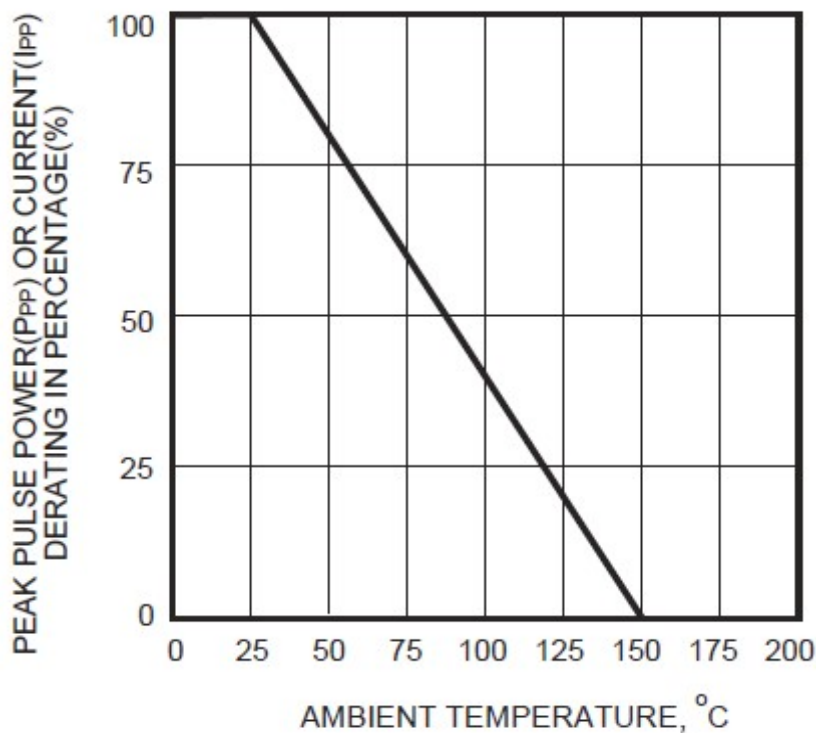

Peak Pulse Power Rating Curve

SMCJ series

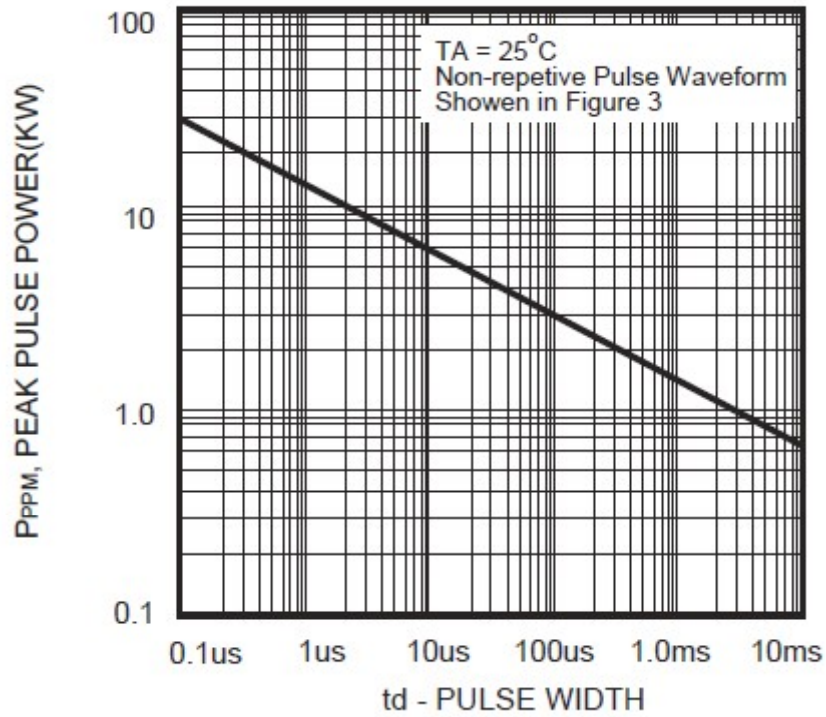

Steady State Power Derating Curve

SMCJ series

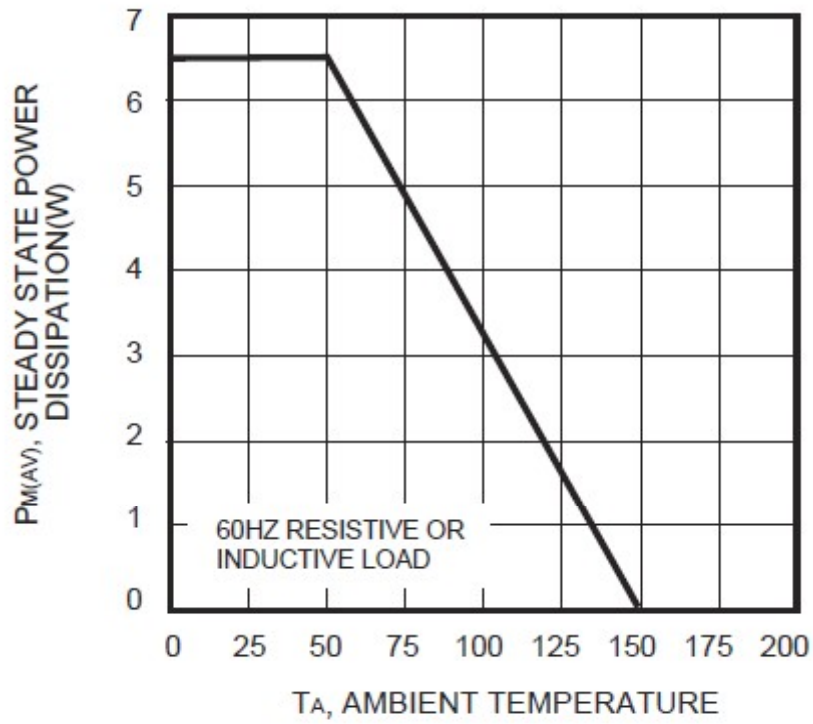

Typical Junction Capacitance

SMCJ series

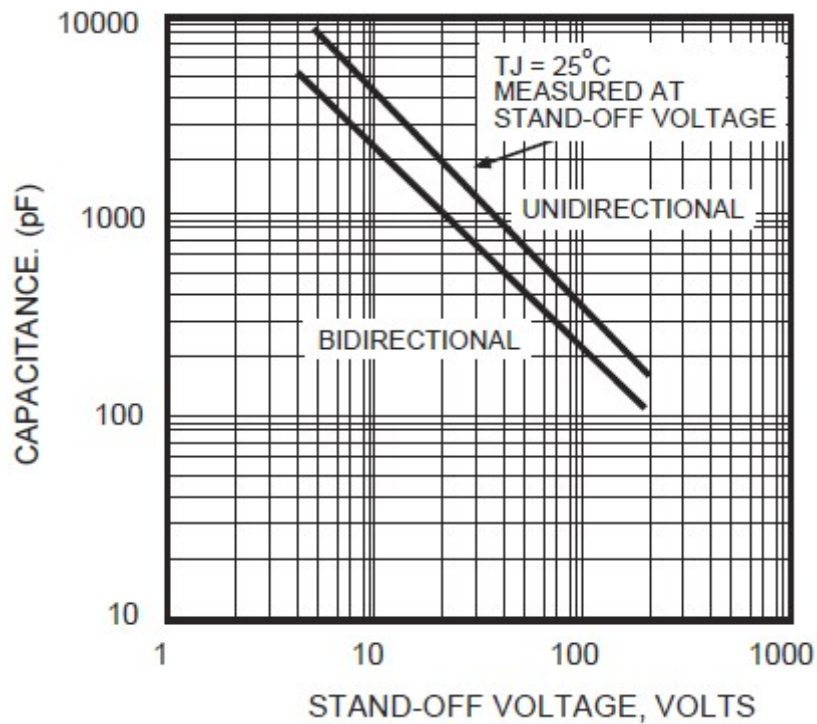

RoHS Compliant Declaration

We hereby declare that the components delivered to your company are compliant with RoHS directive 2015/863/EU.

Warehouse Storage Conditions of Products

(I) Storage Conditions :

- 1.Storage Temperature : $-10^{\circ}\text{C} \sim +40^{\circ}\text{C}$
- 2.Relative Humidity : $\leq 75\%RH$
- 3.Keep away from corrosive atmosphere and sunlight.

(II) Period of Storage : 1 year

Safety Approvals



* UL 497B recognized (File # E229991)

Certificates

- (1) IATF 16949 certificate
- (2) ISO 9001 certificate

Test Report

- (1) RoHS test report
- (2) Halogen-free test report

X-ON Electronics

Largest Supplier of Electrical and Electronic Components

Click to view similar products for [ESD Suppressors / TVS Diodes](#) category:

Click to view products by [TKS](#) manufacturer:

Other Similar products are found below :

[60KS200C](#) [D18V0L1B2LP-7B](#) [D5V0F4U5P5-7](#) [DESD5V0U1BB-7](#) [NTE4902](#) [P4KE27CA](#) [P6KE11CA](#) [P6KE39CA-TP](#) [P6KE8.2A](#)
[SA110CA](#) [SA60CA](#) [SA64CA](#) [SMBJ12CATR](#) [SMBJ33CATR](#) [SMBJ8.0A](#) [ESD101-B1-02ELS E6327](#) [ESD105-B1-02EL E6327](#) [ESD112-B1-02EL E6327](#) [ESD119B1W01005E6327XTSA1](#) [ESD5V0L1B02VH6327XTSA1](#) [ESD7451N2T5G](#) [19180-510](#) [CPDT-5V0USP-HF](#)
[3.0SMCJ33CA-F](#) [3.0SMCJ36A-F](#) [HSPC16701B02TP](#) [D3V3Q1B2DLP3-7](#) [D55V0M1B2WS-7](#) [DESD5V0U1BL-7B](#) [DRTR5V0U4SL-7](#)
[SCM1293A-04SO](#) [ESD200-B1-CSP0201 E6327](#) [SM12-7](#) [SMLJ45CA-TP](#) [CEN955 W/DATA](#) [82350120560](#) [VESD12A1A-HD1-GS08](#)
[CPDUR5V0R-HF](#) [CPDQC5V0U-HF](#) [CPDQC5V0USP-HF](#) [CPDQC5V0-HF](#) [D1213A-01LP4-7B](#) [D1213A-02WL-7](#) [MMAD1108/TR13](#)
[5KP100A](#) [5KP15A](#) [5KP18A](#) [5KP48A](#) [5KP90A](#) [5KP90CA](#)