

**THINKING ELECTRONIC INDUSTRIAL CO., LTD.**

HEAD OFFICE: 12F, No.93, Dashun 1st Rd., Zuoying Dist., Kaohsiung, Taiwan

TEL: 886-7-5577660 FAX: 886-7-5570560

## MANUFACTURING SITE

- KAOHSIUNG FACTORY 1: No. 51, Kaifa Rd., N.E.P.Z, Kaohsiung City 81170, Taiwan  
TEL: 886-7-9616668 FAX: 886-7-9616698
- KAOHSIUNG FACTORY 2: No. 2-2, Xinjian S. Rd., N.E.P.Z., Kaohsiung City 81170, Taiwan  
TEL: 886-7-9630001 FAX: 886-7-3635113
- CHANGZHOU FACTORY: No.6 Longmen Rd., Wujin High & New-Tech Industrial  
Development Zone, Changzhou, Jiangsu, China 213161  
TEL: 86-519-86578999 FAX: 86-519-86558643
- DONG GUAN FACTORY: No.45, East Rd., Sha-Tao Dist., Chang-An Town,  
Dongguan City, Guangdong, China 523863  
TEL: 86-769-85542016 FAX: 86-769-85546890
- YICHANG FACTORY: No. 283 Xiaoting Avenue, Xiaoting Dist., Yichang  
City 443007, Hubei, China  
TEL: 86-717-6510010 FAX: 86-717-6511430

**SPECIFICATION FOR APPROVAL**

CUSTOMER 立創電子

CERTIFIED \_\_\_\_\_

MODEL/TYPE \_\_\_\_\_

PART NO. SMF36CA (RoHS+HF)

APPLICATION \_\_\_\_\_

CUSTOMER P/N \_\_\_\_\_

ISSUE DATE Mar.13,2021

REV. NO. \_\_\_\_\_

REV. DATE \_\_\_\_\_

FOR CUSTOMER APPROVAL	CHECKED BY
	<i>Yuan Feng</i>
	<b>APPROVED BY</b>
	<i>Huaifang Zhang</i>





**REVISED RECORD SHEET**

REV. NO	REV. DATE	REVISED CONTENT



<b>INDEX</b>	<b>Page</b>
■ Part Number Code	1
■ Structure and Dimensions	2
■ Electrical Characteristics	3 ~ 4
■ Reliability	5
■ Soldering Recommendation	6
■ Packaging	7
■ Pulse Waveform	8
■ Pulse Derating Curve	8
■ Peak Pulse Power Rating Curve	9
■ Steady State Power Derating Curve	10
■ Typical Junction Capacitance	11
■ RoHS Compliant Declaration	12
■ Warehouse Storage Conditions of Products	12
■ Certificates & Test Report	13

Part Number Code

Example :

**SMF**    **36**    **CA**  
 (1)        (2)        (3)

No.	Item	Digit	Specification
(1)	Product Type	SMF	Thinking Power TVS SMD Type
(2)	Reverse Stand off Voltage ( $V_{RWM}$ )	36	36=36 $V_{RWM}$
(3)	Type Code	CA	Bi-directional 5% VBR Voltage Tolerance

Structure and Dimensions

Unit:inch(millimeter)

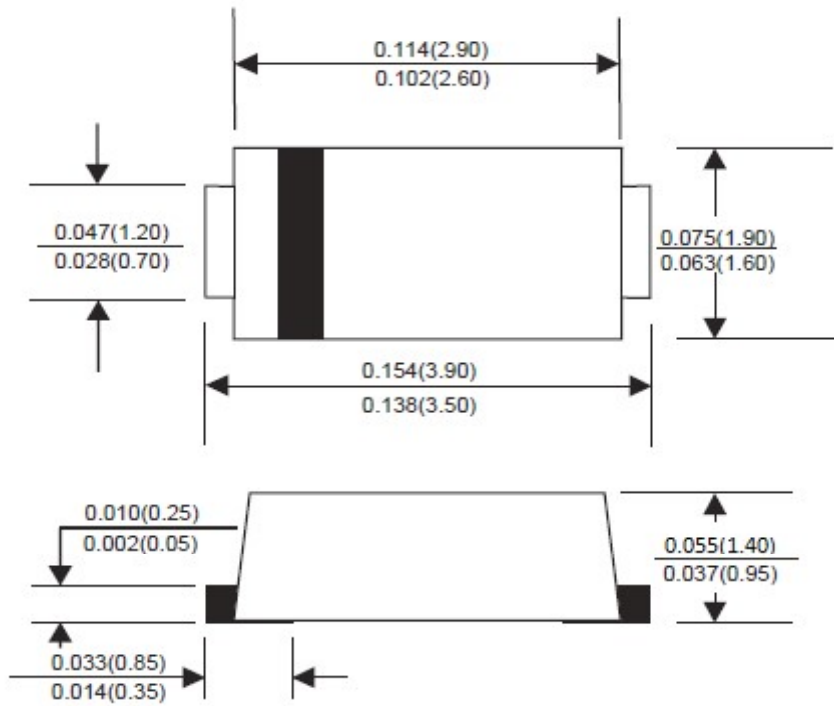

\*The Cathode bend for Uni-directional product only.

## Electrical Characteristics

Peak power dissipation with a 10/1000 $\mu$ s waveform : 200W

Operating junction and storage temperature range : -55~+150 °C

Part No. (Uni)	Part No. (Bi)	Reverse Stand off Voltage	Breakage Voltage VBR @ IT		Test Current	Maximum Clamping Voltage VC @ Ipp	Maximum Peak Pulse Current	Maximum Reverse Leakage IR @VRWM	Marking Code	
			VRWM ( V )	Min( V )					Max( V )	IT( mA )
SMF5.0A	SMF5.0CA	5	6.4	7	10	9.2	21.7	400	FE.	KE.
SMF6.0A	SMF6.0CA	6	6.67	7.37	10	10.3	19.4	400	FG.	KG.
SMF6.5A	SMF6.5CA	6.5	7.22	7.98	10	11.2	17.9	250	FK.	KK.
SMF7.0A	SMF7.0CA	7	7.78	8.6	10	12	16.7	100	FM.	KM.
SMF7.5A	SMF7.5CA	7.5	8.33	9.21	1	12.9	15.5	50	FP.	KP.
SMF8.0A	SMF8.0CA	8	8.89	9.83	1	13.6	14.7	25	FR.	KR.
SMF8.5A	SMF8.5CA	8.5	9.44	10.4	1	14.4	13.9	10	FT.	KT.
SMF9.0A	SMF9.0CA	9	10	11.1	1	15.4	13	5	FV.	KV.
SMF10A	SMF10CA	10	11.1	12.3	1	17	11.8	2.5	FX.	KX.
SMF11A	SMF11CA	11	12.2	13.5	1	18.2	11	2.5	FZ.	KZ.
SMF12A	SMF12CA	12	13.3	14.7	1	19.9	10.1	2.5	HE.	LE.
SMF13A	SMF13CA	13	14.4	15.9	1	21.5	9.3	1	HG.	LG.
SMF14A	SMF14CA	14	15.6	17.2	1	23.2	8.6	1	HK.	LK.
SMF15A	SMF15CA	15	16.7	18.5	1	24.4	8.2	1	HM.	LM.
SMF16A	SMF16CA	16	17.8	19.7	1	26	7.7	1	HP.	LP.
SMF17A	SMF17CA	17	18.9	20.9	1	27.6	7.2	1	HR.	LR.
SMF18A	SMF18CA	18	20	22.1	1	29.2	6.8	1	HT.	LT.
SMF20A	SMF20CA	20	22.2	24.5	1	32.4	6.2	1	HV.	LV.
SMF22A	SMF22CA	22	24.4	26.9	1	35.5	5.6	1	HX.	LX.
SMF24A	SMF24CA	24	26.7	29.5	1	38.9	5.1	1	HZ.	LZ.
SMF26A	SMF26CA	26	28.9	31.9	1	42.1	4.8	1	JE.	ME.
SMF28A	SMF28CA	28	31.1	34.4	1	45.4	4.4	1	JG.	MG.
SMF30A	SMF30CA	30	33.3	36.8	1	48.4	4.1	1	JK.	MK.
SMF33A	SMF33CA	33	36.7	40.6	1	53.3	3.8	1	JM.	MM.
SMF36A	SMF36CA	36	40	44.2	1	58.1	3.4	1	JP.	MP.
SMF40A	SMF40CA	40	44.4	49.1	1	64.5	3.1	1	JR.	MR.
SMF43A	SMF43CA	43	47.8	52.8	1	69.4	2.9	1	JT.	MT.
SMF45A	SMF45CA	45	50	55.3	1	72.7	2.8	1	JV.	MV.
SMF48A	SMF48CA	48	53.3	58.9	1	77.4	2.6	1	JX.	MX.
SMF51A	SMF51CA	51	56.7	62.7	1	82.4	2.4	1	JZ.	MZ.
SMF54A	SMF54CA	54	60	66.3	1	87.1	2.3	1	XE.	NE.
SMF58A	SMF58CA	58	64.4	71.2	1	93.6	2.1	1	XG.	NG.
SMF60A	SMF60CA	60	66.7	73.7	1	96.8	1.8	1	XK.	NK.

Electrical CharacteristicsPeak power dissipation with a 10/1000 $\mu$ s waveform : 200W

Operating junction and storage temperature range : -55~+150 °C

Part No. (Uni)	Part No. (Bi)	Reverse Stand off Voltage	Breakage Voltage VBR @ IT		Test Current IT( mA )	Maximum Clamping Voltage VC @ Ipp	Maximum Peak Pulse Current Ipp(A)	Maximum Reverse Leakage IR @VRWM	Marking Code	
			VRWM ( V )	Min( V )					Max( V )	Uni
SMF64A	SMF64CA	64	71.1	78.6	1	103	1.7	1	XM.	NM.
SMF70A	SMF70CA	70	77.8	86	1	113	1.5	1	XP.	NP.
SMF75A	SMF75CA	75	83.3	92.1	1	121	1.4	1	XR.	NR.
SMF78A	SMF78CA	78	86.7	95.8	1	126	1.4	1	XT.	NT.
SMF85A	SMF85CA	85	94.4	104	1	137	1.3	1	XV.	NV.
SMF90A	SMF90CA	90	100	111	1	146	1.2	1	XX.	NX.
SMF100A	SMF100CA	100	111	123	1	162	1.1	1	XZ.	NZ.
SMF110A	SMF110CA	110	122	135	1	177	1	1	TE.	PE.
SMF120A	SMF120CA	120	133	147	1	193	0.9	1	TG.	PG.
SMF130A	SMF130CA	130	144	159	1	209	0.8	1	TK.	PK.
SMF150A	SMF150CA	150	167	185	1	243	0.7	1	TM.	PM.
SMF160A	SMF160CA	160	178	197	1	259	0.7	1	TP.	PP.
SMF170A	SMF170CA	170	189	209	1	275	0.6	1	TR.	PR.

Reliability

Item	Standard	Test conditions / Methods	Specifications
HTRB (High Temp. Reverse Bias Test)	MIL-STD-750D METHOD 1038.3 Method 103	Test Temp. : 150°C Duration 168 hrs with rated VRWM	Electrical properties meet Specifications
PCT (Pressure Cooker Test)	MIL-STD-19500 EAPPENDIX C	Test Temp. : 121 °C Pressure:1.2Kg Duration: 96 hrs	Electrical properties meet Specifications
TCT	MIL-STD-750D METHOD 1051.5	Test Temp. : -55°C ~+150°C 20 cycles	Electrical properties meet Specifications
Forward Surge	MIL-STD-750D METHOD 4066.3	Sine half wave 8.3mS 1 shot IFSM:20A forSMF 40A for SMA 100A for SMB 200A for SMC For Uni-directional product only.	Electrical properties meet Specifications
Soldering Heat	MIL-STD-750D METHOD 2031.2	Test Temp. : 260°C Duration:10 sec 1cycle	Electrical properties meet Specifications



## Soldering Recommendation

### ■ IR-reflow soldering profile

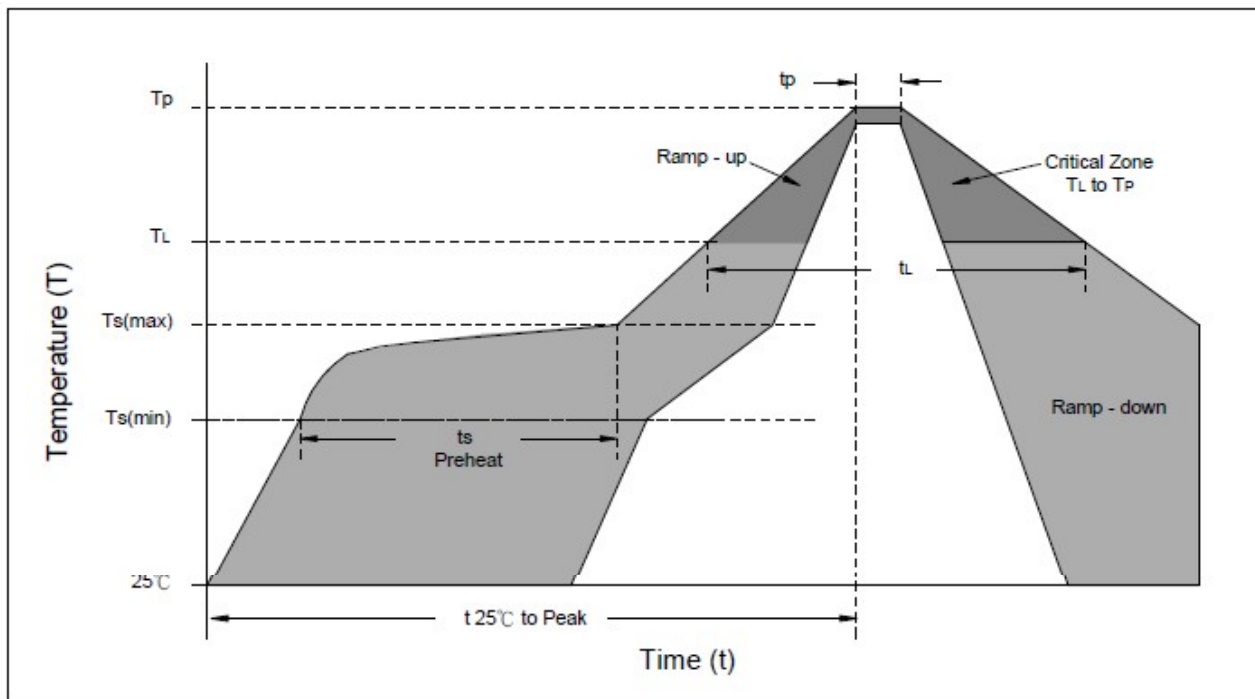

Reflow Condition	Lead-free assembly
<b>Preheat</b> -Temperature Min(Ts min) -Temperature Min(Ts max) -Time (min to max) (ts)	150°C 200°C 60 – 180 seconds
<b>Average ramp up rate</b> -Temperature Liquidus (TL) to peak	3°C/second max
<b>Ts(max) to TL</b> -Ramp-up Rate	3°C/second max.
<b>Reflow</b> -Temperature Liquidus (TL) -Time (tl)	217°C 60 – 150 seconds
<b>Peak Temperature (TP)</b>	260°C
<b>Time within 5°C of actual peak Temperature(tp)</b>	20 – 40 seconds
<b>Ramp-down Rate</b>	6°C/second max.
<b>Time 25°C to peak Temperature(TP)</b>	8 minutes max.
<b>Do not exceed</b>	260°C

## Packaging

### ■ Taping Specification

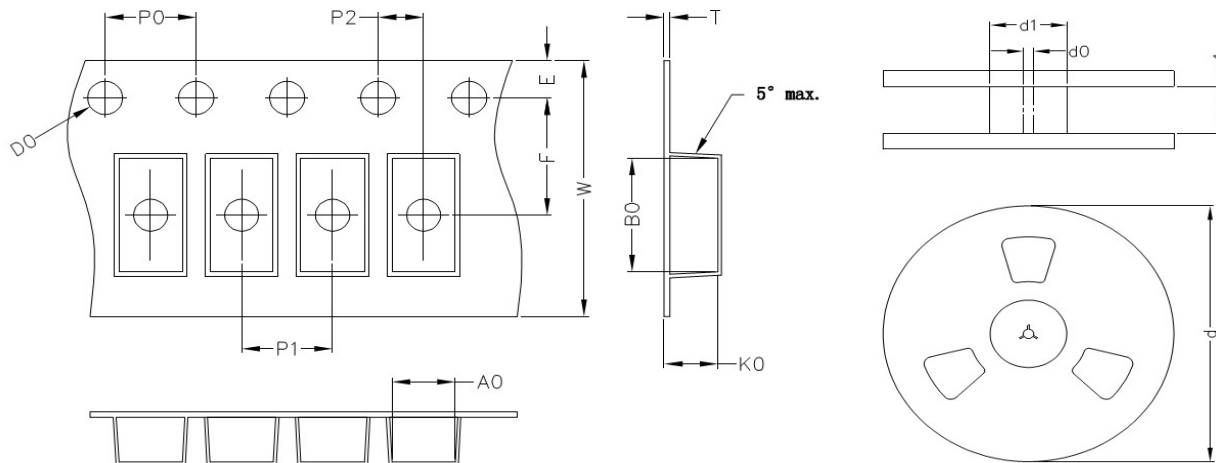

(Unit : mm)

Index	A0	B0	K0	D0	E	F	P0	P1	P2	T	W	d (7")	d1	d0	w1
SMF	2	3.95	1.45	1.55	1.75	3.5	4	4	2	0.23	8	178	60	13	9.5

Notes : 1.The tolerance of carrier tape and top cover is  $\pm 0.1$ mm,the tolerance of reel is  $\pm 2$ mm

Notes : 2.For the SMF series, different reel materials will produce differently structured reels

### ■ Quantity

Series Type	Reel size	Quantity (pcs/reel)
SMF	7"	3,000

Pulse Waveform

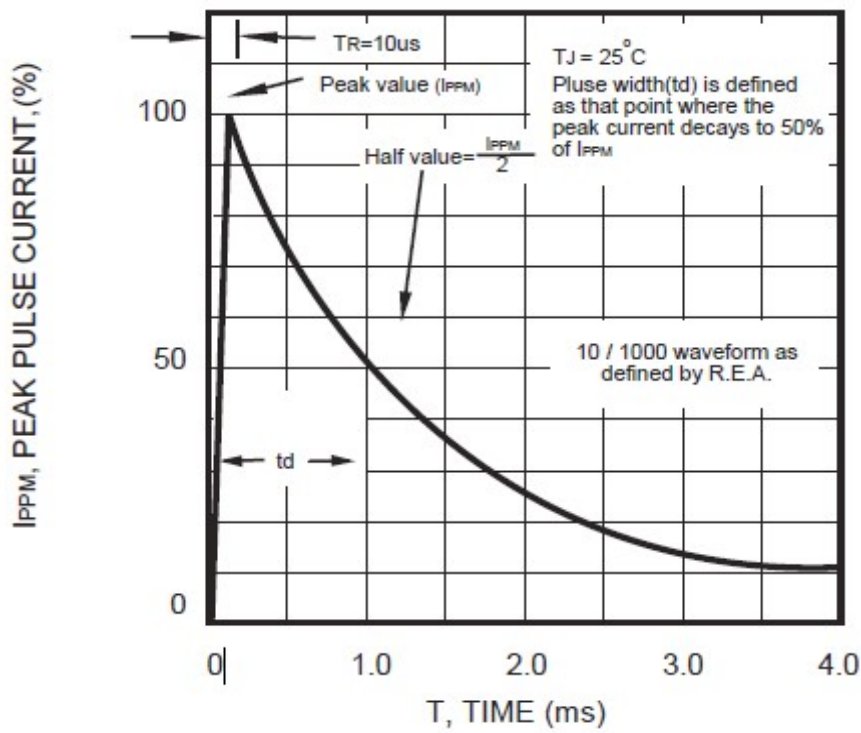

Pulse Derating Curve

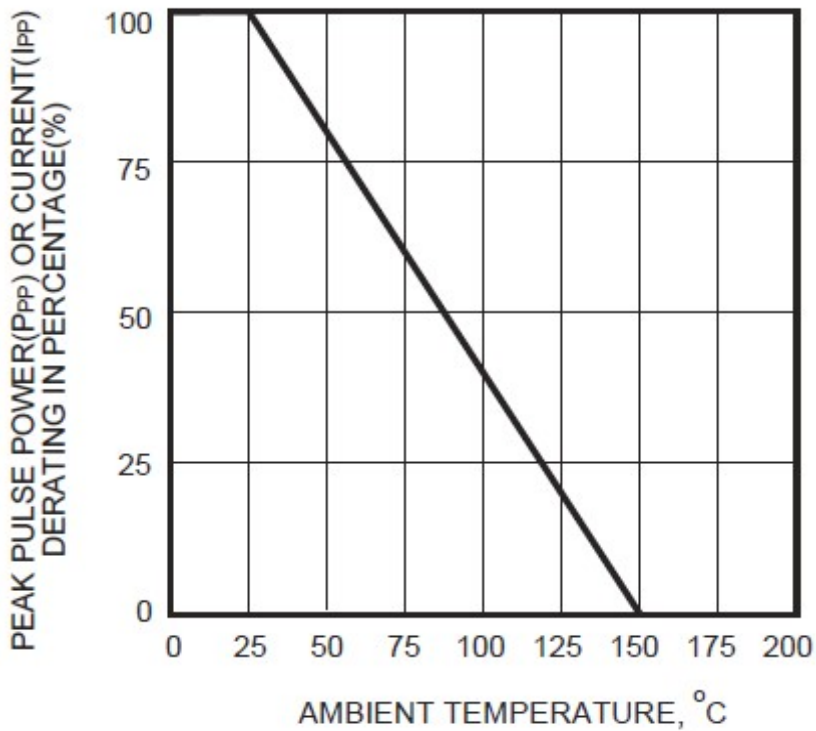

Peak Pulse Power Rating Curve

SMF series

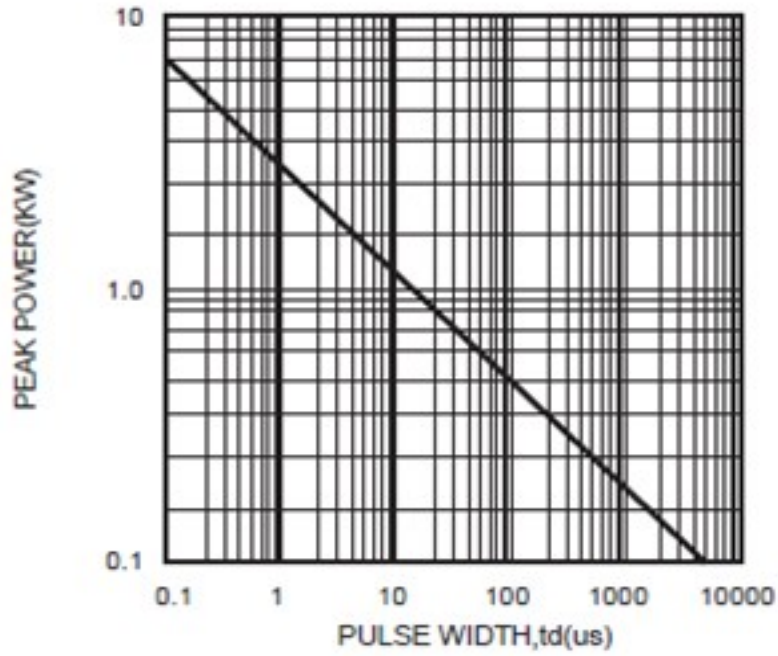

Steady State Power Derating Curve

SMF series

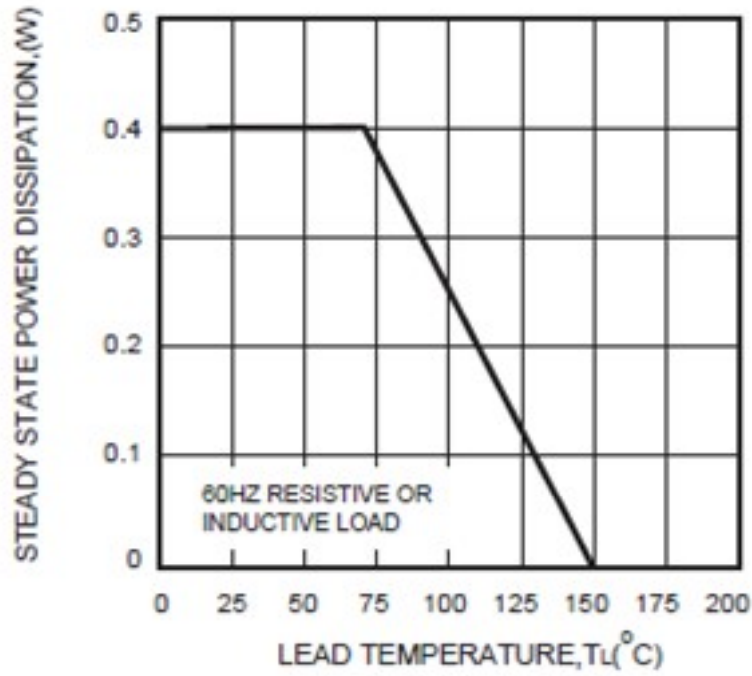

Typical Junction Capacitance

SMF series

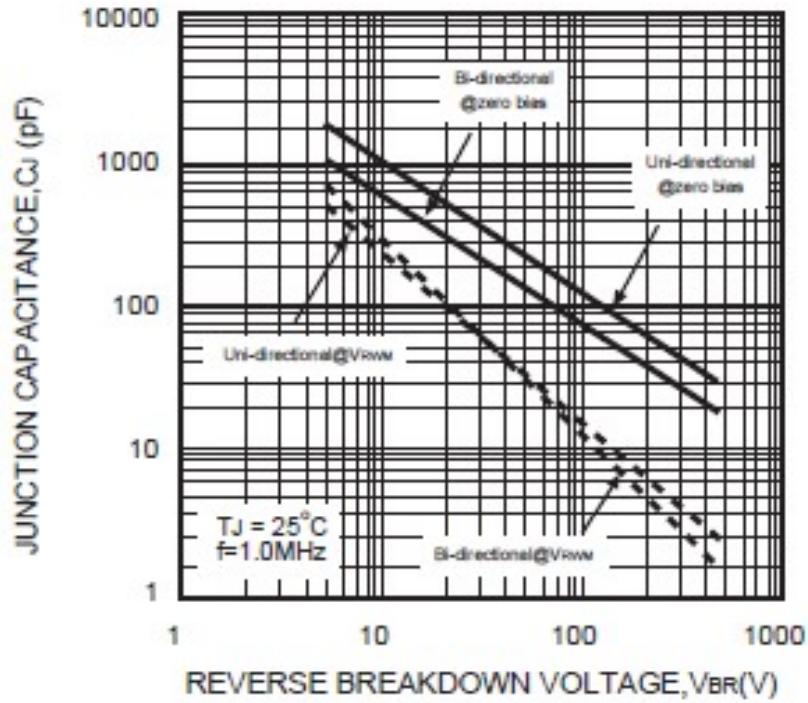

### RoHS Compliant Declaration

We hereby declare that the components delivered to your company are compliant with RoHS directive 2015/863/EU.

### Warehouse Storage Conditions of Products

(I) Storage Conditions :

- 1.Storage Temperature :  $-10^{\circ}\text{C} \sim +40^{\circ}\text{C}$
- 2.Relative Humidity :  $\leq 75\%RH$
- 3.Keep away from corrosive atmosphere and sunlight.

(II) Period of Storage : 1 year



---

Certificates

- (1) IATF 16949 certificate
- (2) ISO 9001 certificate

Test Report

- (1) RoHS test report
- (2) Halogen-free test report



## X-ON Electronics

Largest Supplier of Electrical and Electronic Components

*Click to view similar products for [ESD Suppressors / TVS Diodes](#) category:*

*Click to view products by [TKS](#) manufacturer:*

Other Similar products are found below :

[60KS200C](#) [D18V0L1B2LP-7B](#) [D5V0F4U5P5-7](#) [DESD5V0U1BB-7](#) [NTE4902](#) [P4KE27CA](#) [P6KE11CA](#) [P6KE39CA-TP](#) [P6KE8.2A](#)  
[SA110CA](#) [SA60CA](#) [SA64CA](#) [SMBJ12CATR](#) [SMBJ33CATR](#) [SMBJ8.0A](#) [ESD101-B1-02ELS E6327](#) [ESD105-B1-02EL E6327](#) [ESD112-B1-02EL E6327](#) [ESD119B1W01005E6327XTSA1](#) [ESD5V0L1B02VH6327XTSA1](#) [ESD7451N2T5G](#) [19180-510](#) [CPDT-5V0USP-HF](#)  
[3.0SMCJ33CA-F](#) [3.0SMCJ36A-F](#) [HSPC16701B02TP](#) [D3V3Q1B2DLP3-7](#) [D55V0M1B2WS-7](#) [DESD5V0U1BL-7B](#) [DRTR5V0U4SL-7](#)  
[SCM1293A-04SO](#) [ESD200-B1-CSP0201 E6327](#) [SM12-7](#) [SMLJ45CA-TP](#) [CEN955 W/DATA](#) [82350120560](#) [VESD12A1A-HD1-GS08](#)  
[CPDUR5V0R-HF](#) [CPDQC5V0U-HF](#) [CPDQC5V0USP-HF](#) [CPDQC5V0-HF](#) [D1213A-01LP4-7B](#) [D1213A-02WL-7](#) [MMAD1108/TR13](#)  
[5KP100A](#) [5KP15A](#) [5KP18A](#) [5KP48A](#) [5KP90A](#) [5KP90CA](#)