

# 氧化锌压敏电阻器：TVR 系列

## 浪涌保护用插件型



### ■ 特性

1. 符合RoHS
2. 可提供无卤要求的系列产品
3. 本体尺寸：Φ5mm ~ Φ20mm
4. 宽工作电压范围：11Vac ~ 1000Vac
5. 工作温度范围：-40°C ~ +105°C  
储存温度范围：-40°C ~ +125°C
6. 安规认证：UL 1449 4<sup>th</sup> / cUL / TUV/ VDE/ CQC

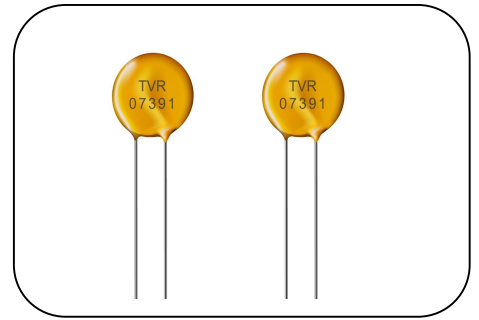

### ■ 用途

1. 电源供应器
2. 家用电器
3. 工业设备
4. 通信设备
5. 智能控制型电表
6. 电力线智能通讯设备
7. 照明
8. 光伏系统

### ■ 编码规则

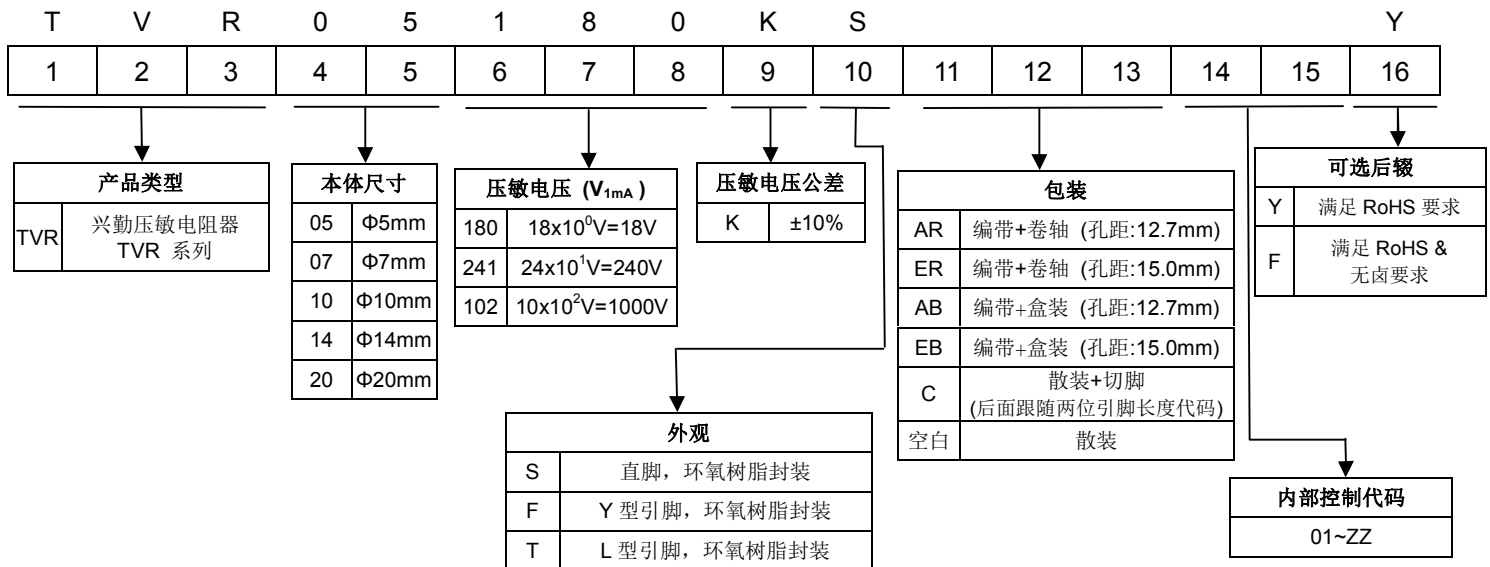

备注：包装及内部控制代码未使用时，第 11 码为可选后缀。

# 氧化锌压敏电阻器：TVR 系列

## 浪涌保护用插件型



### ■ 结构与尺寸

#### ■ S 型 (直脚)

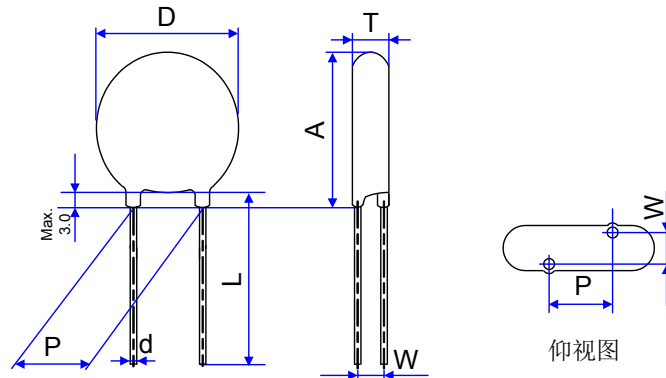

(单位：mm)

系列	D	Lmin.	d	P	Amax.	Tmax.	W
TVR05	5.0~7.0	26.5	0.6±0.02	5.0±0.5 (TVR180-561 适用) 5.0±1.0 (TVR621-751 适用)	9.0	请见 电气特性表	
TVR07	6.5~9.0	26.5	0.6±0.02	5.0±0.5 (TVR180-561 适用) 5.0±1.0 (TVR621-821 适用)	11.0 (TVR07180-621 适用) 11.5 (TVR07681-821 适用)		
TVR10	9.5~12.5 9.5~13.5 (TVR10182 适用)	26.5	0.8±0.02	7.5±0.5 (TVR10180-561 适用) 7.5±1.0 (TVR10621-182 适用)	15.0 (TVR10180-112 适用) 15.5 (TVR10122-182 适用)		
TVR14	13.5~16.0	26.5	0.8±0.02	7.5±0.5 (TVR14180-561 适用) 7.5±1.0 (TVR14621-182 适用)	18.5 (TVR14180-511 适用) 19.0 (TVR14561-182 适用)		
TVR20	19.5~22.0	22.5	1.0±0.02	10±1	25.5 (TVR20180-511 适用) 26.0 (TVR20561-112 适用) 26.5 (TVR20122-182 适用)		

# 氧化锌压敏电阻器：TVR 系列

## 浪涌保护用插件型



### ■ F型 (Y型引脚)

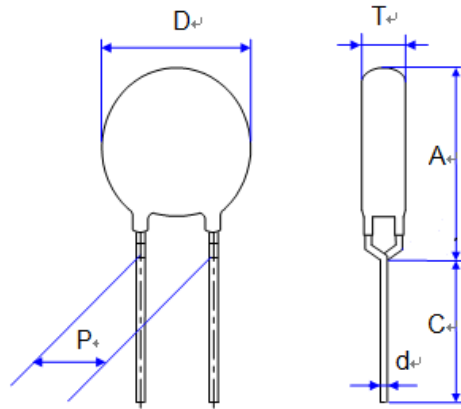

(单位：mm)

系列	D	Cmin.	d	P	Amax.	Tmax.
TVR05	5.0~7.0	20	0.6±0.02	5.0±0.5 (TVR05180-561 适用) 5.0±1.0 (TVR05621-751 适用)	9.5	请见电气特性表
TVR07	6.5~9.0	20	0.6±0.02	5.0±0.5 (TVR07180-561 适用) 5.0±1.0 (TVR07621-821 适用)	11.5	
TVR10	9.5~12.5 9.5~13.5 (TVR10182 适用)	20	0.8±0.02	7.5±0.5 (TVR10180-561 适用) 7.5±1.0 (TVR10621-182 适用)	16.0	
TVR14	13.5 ~16.0	20	0.8±0.02	7.5±0.5 (TVR14180-561 适用) 7.5±1.0 (TVR14621-182 适用)	19.0	
TVR20	19.5~22.0	20	1.0±0.02	10±1	26.5	

### ■ T型 (L型引脚)

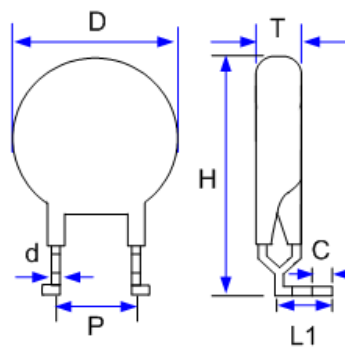

(单位：mm)

系列	D	C	d	P	Hmax.	L1	Tmax.
TVR10	9.5~12.5 9.5~13.5 (TVR10182 适用)	3.8±0.8	0.8±0.02	7.5±1	20.0	7.0±1	请见电气特性表
TVR14	13.5 ~16.0		0.8±0.02	7.5±1	23.5	10.0±1	
TVR20	19.5~22		1.0±0.02	10±1	30.5	9.0±1	

# 氧化锌压敏电阻器：TVR 系列

## 浪涌保护用插件型



### ■ 电气特性

#### 05mm系列

型号	压敏电压 (@ 1mA DC)	最大连续 工作电压		最大限制电压 (8/20 $\mu$ s)		最大 冲击电流 (8/20 $\mu$ s)	额定 功率	最大能量 (10/1000 $\mu$ s)	产品尺寸		
	$V_{1mA}$	$V_{AC(rms)}$	$V_{DC}$	$V_P$	$I_P$	$I_{max}$	P	$W_{max}$	$T_{min}$	$T_{max}$	W $\pm 1.0$
	(V)	(V)	(V)	(V)	(A)	(A)	(W)	(J)	(mm)		
TVR05180	18 (16~20)	11	14	40	1.0	100	0.01	0.4	2.2	3.9	1.5
TVR05220	22 (20~24)	14	18	48	1.0	100	0.01	0.5	2.2	4.1	1.5
TVR05270	27 (24~30)	17	22	60	1.0	100	0.01	0.6	2.4	4.3	1.5
TVR05330	33 (30~36)	20	26	73	1.0	100	0.01	0.8	2.6	4.5	1.5
TVR05390	39 (35~43)	25	31	86	1.0	100	0.01	0.9	2.6	4.6	1.5
TVR05470	47 (42~52)	30	38	104	1.0	100	0.01	1.1	2.3	4.2	1.5
TVR05560	56 (50~62)	35	45	123	1.0	100	0.01	1.3	2.6	4.3	1.5
TVR05680	68 (61~75)	40	56	150	1.0	100	0.01	1.6	2.8	4.6	1.5
TVR05820	82 (74~90)	50	65	145	5.0	400	0.1	2.5	2.0	3.9	1.5
TVR05101	100 (90~110)	60	85	175	5.0	400	0.1	3.0	2.1	4.1	1.6
TVR05121	120 (108~132)	75	100	210	5.0	400	0.1	4.0	2.5	4.3	1.8
TVR05151	150 (135~165)	95	125	260	5.0	400	0.1	4.8	2.0	4.6	1.6
TVR05181	180 (162~198)	115	150	315	5.0	400	0.1	5.9	2.0	3.9	1.4
TVR05201	200 (180~220)	130	170	355	5.0	400	0.1	6.5	2.1	4.0	1.5
TVR05221	220 (198~242)	140	180	380	5.0	400	0.1	7.0	2.1	4.0	1.5
TVR05241	240 (216~264)	150	200	415	5.0	400	0.1	8.0	2.3	4.2	1.6
TVR05271	270 (243~297)	175	225	475	5.0	400	0.1	8.5	2.4	4.4	1.7
TVR05301	300 (270~330)	195	250	525	5.0	400	0.1	8.5	2.7	4.4	1.9
TVR05331	330 (297~363)	215	275	585	5.0	400	0.1	9.2	2.8	4.5	2.0
TVR05361	360 (324~396)	230	300	620	5.0	400	0.1	10	2.9	4.6	2.1
TVR05391	390 (351~429)	250	320	675	5.0	400	0.1	12	3.1	4.8	2.3
TVR05431	430 (387~473)	275	350	745	5.0	400	0.1	13	3.0	5.1	2.3
TVR05471	470 (423~517)	300	385	810	5.0	400	0.1	15	3.2	5.2	2.4
TVR05511	510 (459~561)	320	410	878	5.0	400	0.1	16	3.4	5.4	2.6
TVR05561	560 (504~616)	350	450	962	5.0	400	0.1	18	3.6	5.5	2.8
TVR05621	620 (558~682)	395	510	1050	5.0	400	0.1	18	3.9	5.9	3.0
TVR05681	680 (612~748)	420	560	1120	5.0	400	0.1	18	4.1	6.2	3.2
TVR05751	750 (675~825)	465	615	1240	5.0	400	0.1	18	4.4	6.4	3.5

# 氧化锌压敏电阻器：TVR 系列

## 浪涌保护用插件型



### 07mm系列

型号	压敏电压 (@ 1mA DC)		最大连续 工作电压		最大限制电压 (8/20 $\mu$ s)		最大 冲击电流 (8/20 $\mu$ s)	额定 功率	最大能量 (10/1000 $\mu$ s)	产品尺寸		
	$V_{1mA}$	$V_{AC(rms)}$	$V_{DC}$	$V_P$	$I_P$	$I_{max}$	P	$W_{max}$	$T_{min}$	$T_{max}$	W $\pm 1.0$	
	(V)	(V)	(V)	(V)	(A)	(A)	(W)	(J)	(mm)			
TVR07180	18 (16~20)	11	14	36	2.5	250	0.02	0.9	2.2	3.9	1.3	
TVR07220	22 (20~24)	14	18	43	2.5	250	0.02	1.1	2.2	4.1	1.4	
TVR07270	27 (24~30)	17	22	53	2.5	250	0.02	1.4	2.4	4.3	1.5	
TVR07330	33 (30~36)	20	26	65	2.5	250	0.02	1.7	2.6	4.5	1.7	
TVR07390	39 (35~43)	25	31	77	2.5	250	0.02	2.1	2.6	4.6	1.8	
TVR07470	47 (42~52)	30	38	93	2.5	250	0.02	2.5	2.3	4.2	1.9	
TVR07560	56 (50~62)	35	45	110	2.5	250	0.02	3.1	2.6	4.3	2.0	
TVR07680	68 (61~75)	40	56	135	2.5	250	0.02	3.6	2.3	4.6	2.1	
TVR07820	82 (74~90)	50	65	135	10	1200	0.25	5.5	2.0	3.9	1.5	
TVR07101	100 (90~110)	60	85	165	10	1200	0.25	6.5	2.1	4.1	1.6	
TVR07121	120 (108~132)	75	100	200	10	1200	0.25	7.8	2.5	4.3	1.8	
TVR07151	150 (135~165)	95	125	250	10	1200	0.25	9.7	2.0	4.6	1.6	
TVR07181	180 (162~198)	115	150	300	10	1200	0.25	11.7	2.0	3.9	1.4	
TVR07201	200 (180~220)	130	170	340	10	1200	0.25	13	2.1	4.0	1.5	
TVR07221	220 (198~242)	140	180	360	10	1200	0.25	14	2.1	4.0	1.5	
TVR07241	240 (216~264)	150	200	395	10	1200	0.25	15	2.3	4.2	1.6	
TVR07271	270 (243~297)	175	225	455	10	1200	0.25	18	2.4	4.4	1.7	
TVR07301	300 (270~330)	195	250	500	10	1200	0.25	21	2.7	4.4	1.9	
TVR07331	330 (297~363)	215	275	550	10	1200	0.25	23	2.8	4.5	2.0	
TVR07361	360 (324~396)	230	300	595	10	1200	0.25	25	2.9	4.6	2.1	
TVR07391	390 (351~429)	250	320	650	10	1200	0.25	25	3.1	4.8	2.3	
TVR07431	430 (387~473)	275	350	710	10	1200	0.25	28	3.0	5.1	2.3	
TVR07471	470 (423~517)	300	385	775	10	1200	0.25	30	3.2	5.2	2.4	
TVR07511	510 (459~561)	320	410	845	10	1200	0.25	33	3.4	5.4	2.6	
TVR07561	560 (504~616)	350	450	930	10	1200	0.25	33	3.6	5.5	2.8	
TVR07621	620 (558~682)	395	510	1020	10	1200	0.25	35	3.9	5.9	3.0	
TVR07681	680 (612~748)	420	560	1120	10	1200	0.25	35	4.1	6.2	3.2	
TVR07751	750 (675~825)	465	615	1235	10	1200	0.25	38	4.4	6.4	3.5	
TVR07821	820 (738~902)	510	670	1355	10	1200	0.25	42	4.5	6.4	3.2	

# 氧化锌压敏电阻器：TVR 系列

## 浪涌保护用插件型



### 10mm系列

型号	压敏电压 (@ 1mA DC)	最大连续 工作电压		最大限制电压 (8/20 $\mu$ s)		最大 冲击电流 (8/20 $\mu$ s)	额定 功率	最大能量 (10/1000 $\mu$ s)	产品尺寸		
	$V_{1mA}$	$V_{AC(rms)}$	$V_{DC}$	$V_P$	$I_P$	$I_{max}$	P	$W_{max}$	$T_{min}$	$T_{max}$	W $\pm 1.0$
	(V)	(V)	(V)	(V)	(A)	(A)	(W)	(J)	(mm)		
TVR10180	18 (16~20)	11	14	36	5.0	500	0.05	2.1	2.6	4.3	1.3
TVR10220	22 (20~24)	14	18	43	5.0	500	0.05	2.5	2.6	4.5	1.4
TVR10270	27 (24~30)	17	22	53	5.0	500	0.05	3.0	2.8	4.7	1.5
TVR10330	33 (30~36)	20	26	65	5.0	500	0.05	4.0	2.9	4.9	1.7
TVR10390	39 (35~43)	25	31	77	5.0	500	0.05	4.6	2.7	5.1	1.8
TVR10470	47 (42~52)	30	38	93	5.0	500	0.05	5.5	2.7	4.5	1.8
TVR10560	56 (50~62)	35	45	110	5.0	500	0.05	7.0	3.0	4.7	1.9
TVR10680	68 (61~75)	40	56	135	5.0	500	0.05	8.2	2.6	5.0	2.2
TVR10820	82 (74~90)	50	65	135	25	2500	0.4	12	2.4	4.3	1.6
TVR10101	100 (90~110)	60	85	165	25	2500	0.4	15	2.6	4.5	1.8
TVR10121	120 (108~132)	75	100	200	25	2500	0.4	18	2.9	4.7	2.0
TVR10151	150 (135~165)	95	125	250	25	2500	0.4	22	2.4	5.0	1.8
TVR10181	180 (162~198)	115	150	300	25	2500	0.4	27	2.4	4.3	1.6
TVR10201	200 (180~220)	130	170	340	25	2500	0.4	30	2.5	4.4	1.7
TVR10221	220 (198~242)	140	180	360	25	2500	0.4	32	2.5	4.4	1.7
TVR10241	240 (216~264)	150	200	395	25	2500	0.4	35	2.7	4.6	1.8
TVR10271	270 (243~297)	175	225	455	25	2500	0.4	40	2.8	4.8	1.9
TVR10301	300 (270~330)	195	250	500	25	2500	0.4	40	3.1	4.8	2.1
TVR10331	330 (297~363)	215	275	550	25	2500	0.4	43	3.2	4.9	2.2
TVR10361	360 (324~396)	230	300	595	25	2500	0.4	47	3.3	5.0	2.3
TVR10391	390 (351~429)	250	320	650	25	2500	0.4	60	3.5	5.2	2.5
TVR10431	430 (387~473)	275	350	710	25	2500	0.4	65	3.4	5.5	2.5
TVR10471	470 (423~517)	300	385	775	25	2500	0.4	70	3.6	5.6	2.6
TVR10511	510 (459~561)	320	410	845	25	2500	0.4	70	3.8	5.8	2.8
TVR10561	560 (504~616)	350	450	930	25	2500	0.4	70	4.0	5.9	3.0
TVR10621	620 (558~682)	395	510	1020	25	2500	0.4	70	4.3	6.3	3.2
TVR10681	680 (612~748)	420	560	1120	25	2500	0.4	70	4.5	6.6	3.4
TVR10751	750 (675~825)	465	615	1235	25	2500	0.4	75	4.8	6.8	3.7
TVR10821	820 (738~902)	510	670	1355	25	2500	0.4	85	4.9	6.8	3.4
TVR10911	910 (819~1001)	550	745	1500	25	2500	0.4	93	5.3	7.2	3.7
TVR10102	1000 (900~1100)	625	825	1650	25	2500	0.4	102	5.5	7.5	4.0
TVR10112	1100 (990~1210)	680	895	1815	25	2500	0.4	115	5.7	8.0	4.3
TVR10122	1200 (1080~1320)	725	975	1980	25	2500	0.4	125	6.0	8.1	5.2
TVR10142	1400 (1260~1540)	820	1140	2300	25	2500	0.4	145	6.6	8.7	6.0
TVR10162	1600 (1440~1760)	910	1300	2630	25	2500	0.4	165	7.1	9.8	6.7
TVR10182	1800 (1620~1980)	1000	1465	2950	25	2500	0.4	185	7.8	10.3	7.4

# 氧化锌压敏电阻器：TVR 系列

## 浪涌保护用插件型



### 14mm系列

型号	压敏电压 (@ 1mA DC)	最大连续 工作电压		最大限制电压 (8/20 $\mu$ s)		最大 冲击电流 (8/20 $\mu$ s)	额定 功率	最大能量 (10/1000 $\mu$ s)	产品尺寸		
	$V_{1mA}$	$V_{AC(rms)}$	$V_{DC}$	$V_P$	$I_P$	$I_{max}$	P	$W_{max}$	$T_{min}$	$T_{max}$	W $\pm 1.0$
	(V)	(V)	(V)	(V)	(A)	(A)	(W)	(J)	(mm)		
TVR14180	18 (16~20)	11	14	36	10	1000	0.1	4.0	2.6	4.3	1.3
TVR14220	22 (20~24)	14	18	43	10	1000	0.1	5.0	2.6	4.5	1.4
TVR14270	27 (24~30)	17	22	53	10	1000	0.1	6.0	2.8	4.7	1.5
TVR14330	33 (30~36)	20	26	65	10	1000	0.1	7.5	2.9	4.9	1.7
TVR14390	39 (35~43)	25	31	77	10	1000	0.1	8.6	2.7	5.1	1.8
TVR14470	47 (42~52)	30	38	93	10	1000	0.1	10	2.7	4.5	1.8
TVR14560	56 (50~62)	35	45	110	10	1000	0.1	11	3.0	4.7	1.9
TVR14680	68 (61~75)	40	56	135	10	1000	0.1	14	3.1	5.0	2.2
TVR14820	82 (74~90)	50	65	135	50	4500	0.6	22	2.4	4.3	1.6
TVR14101	100 (90~110)	60	85	165	50	4500	0.6	28	2.6	4.5	1.8
TVR14121	120 (108~132)	75	100	200	50	4500	0.6	32	2.9	4.7	2.0
TVR14151	150 (135~165)	95	125	250	50	4500	0.6	40	2.4	5.0	1.8
TVR14181	180 (162~198)	115	150	300	50	4500	0.6	52	2.4	4.3	1.6
TVR14201	200 (180~220)	130	170	340	50	4500	0.6	57	2.5	4.4	1.7
TVR14221	220 (198~242)	140	180	360	50	4500	0.6	60	2.5	4.4	1.7
TVR14241	240 (216~264)	150	200	395	50	4500	0.6	63	2.7	4.6	1.8
TVR14271	270 (243~297)	175	225	455	50	4500	0.6	70	2.8	4.8	1.9
TVR14301	300 (270~330)	195	250	500	50	4500	0.6	78	3.1	4.8	2.1
TVR14331	330 (297~363)	215	275	550	50	4500	0.6	85	3.2	4.9	2.2
TVR14361	360 (324~396)	230	300	595	50	4500	0.6	93	3.3	5.0	2.3
TVR14391	390 (351~429)	250	320	650	50	4500	0.6	100	3.5	5.2	2.5
TVR14431	430 (387~473)	275	350	710	50	4500	0.6	115	3.4	5.5	2.5
TVR14471	470 (423~517)	300	385	775	50	4500	0.6	125	3.6	5.6	2.6
TVR14511	510 (459~561)	320	410	845	50	4500	0.6	125	3.8	5.8	2.8
TVR14561	560 (504~616)	350	450	930	50	4500	0.6	125	4.0	5.9	3.0
TVR14621	620 (558~682)	395	510	1020	50	4500	0.6	125	4.3	6.3	3.2
TVR14681	680 (612~748)	420	560	1120	50	4500	0.6	130	4.5	6.6	3.4
TVR14751	750 (675~825)	465	615	1235	50	4500	0.6	143	4.8	6.8	3.7
TVR14821	820 (738~902)	510	670	1355	50	4500	0.6	157	4.9	6.8	3.4
TVR14911	910 (819~1001)	550	745	1500	50	4500	0.6	175	5.3	7.2	3.7
TVR14102	1000 (900~1100)	625	825	1650	50	4500	0.6	190	5.5	7.5	4.0
TVR14112	1100 (990~1210)	680	895	1815	50	4500	0.6	213	5.6	8.0	4.3
TVR14122	1200 (1080~1320)	725	975	1980	50	4500	0.6	230	6.0	8.1	5.2
TVR14142	1400 (1260~1540)	820	1140	2300	50	4500	0.6	250	6.6	8.7	6.0
TVR14162	1600 (1440~1760)	910	1300	2630	50	4500	0.6	315	7.1	9.8	6.7
TVR14182	1800 (1620~1980)	1000	1465	2950	50	4500	0.6	354	7.8	10.3	7.4

# 氧化锌压敏电阻器：TVR 系列

## 浪涌保护用插件型



### 20mm系列

型号	压敏电压 (@ 1mA DC)		最大连续 工作电压		最大限制电压 (8/20μs)		最大 冲击电流 (8/20μs)	额定 功率	最大能量 (10/1000μs)	产品尺寸		
	$V_{1mA}$	$V_{AC(rms)}$	$V_{DC}$	$V_P$	$I_P$	$I_{max}$	P	$W_{max}$	$T_{min}$	$T_{max}$	W ±1.0	
	(V)	(V)	(V)	(V)	(A)	(A)	(W)	(J)	(mm)			
TVR20180	18 (16~20)	11	14	36	20	2000	0.2	11	3.0	4.7	1.3	
TVR20220	22 (20~24)	14	18	43	20	2000	0.2	14	3.0	4.9	1.4	
TVR20270	27 (24~30)	17	22	53	20	2000	0.2	18	3.2	5.1	1.5	
TVR20330	33 (30~36)	20	26	65	20	2000	0.2	23	3.4	5.3	1.7	
TVR20390	39 (35~43)	25	31	77	20	2000	0.2	26	3.1	5.5	1.7	
TVR20470	47 (42~52)	30	38	93	20	2000	0.2	33	3.1	4.9	1.8	
TVR20560	56 (50~62)	35	45	110	20	2000	0.2	41	3.4	5.1	2.0	
TVR20680	68 (61~75)	40	56	135	20	2000	0.2	46	3.5	5.4	2.2	
TVR20820	82 (74~90)	50	65	135	100	6500	1.0	48	2.8	4.7	1.8	
TVR20101	100 (90~110)	60	85	165	100	6500	1.0	51	3.1	4.9	2.0	
TVR20121	120 (108~132)	75	100	200	100	6500	1.0	55	3.3	5.1	2.2	
TVR20151	150 (135~165)	95	125	250	100	6500	1.0	70	2.8	5.4	2.0	
TVR20181	180 (162~198)	115	150	300	100	6500	1.0	84	2.8	4.7	1.8	
TVR20201	200 (180~220)	130	170	340	100	6500	1.0	95	2.9	4.8	1.9	
TVR20221	220 (198~242)	140	180	360	100	6500	1.0	100	2.9	4.8	1.9	
TVR20241	240 (216~264)	150	200	395	100	6500	1.0	108	3.1	5.0	2.0	
TVR20271	270 (243~297)	175	225	455	100	6500	1.0	127	3.2	5.2	2.1	
TVR20301	300 (270~330)	195	250	500	100	6500	1.0	136	3.5	5.2	2.3	
TVR20331	330 (297~363)	215	275	550	100	6500	1.0	150	3.6	5.3	2.4	
TVR20361	360 (324~396)	230	300	595	100	6500	1.0	163	3.7	5.4	2.5	
TVR20391	390 (351~429)	250	320	650	100	6500	1.0	180	3.9	5.6	2.7	
TVR20431	430 (387~473)	275	350	710	100	6500	1.0	190	3.8	5.9	2.7	
TVR20471	470 (423~517)	300	385	775	100	6500	1.0	220	4.0	6.0	2.8	
TVR20511	510 (459~561)	320	410	845	100	6500	1.0	220	4.2	6.2	3.0	
TVR20561	560 (504~616)	350	450	930	100	6500	1.0	220	4.4	6.3	3.2	
TVR20621	620 (558~682)	395	510	1020	100	6500	1.0	220	4.7	6.7	3.4	
TVR20681	680 (612~748)	420	560	1120	100	6500	1.0	230	4.9	7.0	3.6	
TVR20751	750 (675~825)	465	615	1235	100	6500	1.0	255	5.2	7.2	3.9	
TVR20821	820 (738~902)	510	670	1355	100	6500	1.0	282	5.3	7.2	3.6	
TVR20911	910 (819~1001)	550	745	1500	100	6500	1.0	310	5.7	7.6	3.9	
TVR20102	1000 (900~1100)	625	825	1650	100	6500	1.0	342	6.1	7.9	4.2	
TVR20112	1100 (990~1210)	680	895	1815	100	6500	1.0	383	6.2	8.4	4.5	
TVR20122	1200 (1080~1320)	725	975	1980	100	6500	1.0	415	6.4	8.5	5.4	
TVR20142	1400 (1260~1540)	820	1140	2300	100	6500	1.0	480	7.0	9.1	6.2	
TVR20162	1600 (1440~1760)	910	1300	2630	100	6500	1.0	550	7.5	10.2	6.9	
TVR20182	1800 (1620~1980)	1000	1465	2950	100	6500	1.0	620	8.5	10.7	7.6	







# 氧化锌压敏电阻器：TVR 系列

## 浪涌保护用插件型



### ■ 安规认证

安规认证型号	认证机构			
				
	UL1449 4 <sup>th</sup> & cUL	EN/IEC 61051-1, IEC 61051-2, IEC 61051-2-2	IEC 61051-1 IEC 61051-2 IEC 61051-2-2	GB/T10193 GB/T10194
	E314979	J50411784	5944	CQC03001005165 CQC03001007654
TVR05180	√	√	√	√
TVR05220	√	√	√	√
TVR05270	√	√	√	√
TVR05330	√	√	√	√
TVR05390	√	√	√	√
TVR05470	√	√	√	√
TVR05560	√	√	√	√
TVR05680	√	√	√	√
TVR05820	√	√	√	√
TVR05101	√	√	√	√
TVR05121	√	√	√	√
TVR05151	√	√	√	√
TVR05181	√	√	√	√
TVR05201	√	√	√	√
TVR05221	√	√	√	√
TVR05241	√	√	√	√
TVR05271	√	√	√	√
TVR05301	√	√	√	√
TVR05331	√	√	√	√
TVR05361	√	√	√	√
TVR05391	√	√	√	√
TVR05431	√	√	√	√
TVR05471	√	√	√	√
TVR05511	√	√	√	√
TVR05561	√	√	√	√
TVR05621	√	√	√	√
TVR05681	√	√	√	√
TVR05751	√	√		√





备注:

1. UL/cUL/TUV/CQC证书: 操作温度范围是105°C  
VDE证书: 操作温度范围是85°C; 105°C规格正在申请中.

# 氧化锌压敏电阻器：TVR 系列

## 浪涌保护用插件型



安规认证型号	认证机构			
				
	UL1449 4 <sup>th</sup> & cUL	EN/IEC 61051-1, IEC 61051-2, IEC 61051-2-2	IEC 61051-1 IEC 61051-2 IEC 61051-2-2	GB/T10193 GB/T10194
	E314979	J50411784	5944	现行证书号: CQC03001005165 CQC03001007654 新证书号: (见备注) CQC18001199806 CQC18001199789
TVR07180	√	√	√	√
TVR07220	√	√	√	√
TVR07270	√	√	√	√
TVR07330	√	√	√	√
TVR07390	√	√	√	√
TVR07470	√	√	√	√
TVR07560	√	√	√	√
TVR07680	√	√	√	√
TVR07820	√	√	√	√
TVR07101	√	√	√	√
TVR07121	√	√	√	√
TVR07151	√	√	√	√
TVR07181	√	√	√	√
TVR07201	√	√	√	√
TVR07221	√	√	√	√
TVR07241	√	√	√	√
TVR07271	√	√	√	√
TVR07301	√	√	√	√
TVR07331	√	√	√	√
TVR07361	√	√	√	√
TVR07391	√	√	√	√
TVR07431	√	√	√	√
TVR07471	√	√	√	√
TVR07511	√	√	√	√
TVR07561	√	√	√	√
TVR07621	√	√	√	√
TVR07681	√	√	√	√
TVR07751	√	√	√	√
TVR07821	√	√	√	√

备注:

1. CQC现行证书号只会保留至2019/12/31,于2020/1/1开始只有保留新证书号,请使用新证书号做为案件的申请

2. UL/cUL/TUV/CQC证书: 操作温度范围是105°C

VDE证书: 操作温度范围是85°C; 105°C规格正在申请中

# 氧化锌压敏电阻器：TVR 系列

## 浪涌保护用插件型



安规认证型号	认证机构			
				
	UL1449 4 <sup>th</sup> & cUL	EN/IEC 61051-1, IEC 61051-2, IEC 61051-2-2	IEC 61051-1 IEC 61051-2 IEC 61051-2-2	GB/T10193 GB/T10194
	E314979	J50411784	5944	现行证书号: CQC03001005165 CQC03001007654 新证书号: (见备注) CQC18001200336 CQC18001199790
TVR10180	√	√	√	√
TVR10220	√	√	√	√
TVR10270	√	√	√	√
TVR10330	√	√	√	√
TVR10390	√	√	√	√
TVR10470	√	√	√	√
TVR10560	√	√	√	√
TVR10680	√	√	√	√
TVR10820	√	√	√	√
TVR10101	√	√	√	√
TVR10121	√	√	√	√
TVR10151	√	√	√	√
TVR10181	√	√	√	√
TVR10201	√	√	√	√
TVR10221	√	√	√	√
TVR10241	√	√	√	√
TVR10271	√	√	√	√
TVR10301	√	√	√	√
TVR10331	√	√	√	√
TVR10361	√	√	√	√
TVR10391	√	√	√	√
TVR10431	√	√	√	√
TVR10471	√	√	√	√
TVR10511	√	√	√	√
TVR10561	√	√	√	√
TVR10621	√	√	√	√
TVR10681	√	√	√	√
TVR10751	√	√	√	√
TVR10821	√	√	√	√
TVR10911	√	√	√	√
TVR10102	√	√	√	√
TVR10112	√	√	√	√
TVR10122	√	√	√	√
TVR10142	√	√	√	√
TVR10162	√	√	√	√
TVR10182	√	√	√	√

备注:  
 1. CQC现行证书号只会保留至2019/12/31,于2020/1/1开始只有保留新证书号,请使用新证书号做为案件的申请  
 2. UL/cUL/TUV/CQC 证书: 操作温度范围是105°C  
 VDE证书: 操作温度范围是85°C; 105°C规格正在申请中

# 氧化锌压敏电阻器：TVR 系列

## 浪涌保护用插件型



安规认证型号	认证机构						
	UL1449 4 <sup>th</sup> & cUL	EN/IEC 61051-1, IEC 61051-2, IEC 61051-2-2	IEC/EN 60950-1 Annex Q, IEC/EN 62368-1 Annex G.8.2	EN/IEC 61051-1, IEC 61051-2, IEC 61051-2-2	IEC/EN 62368-1 Annex G.8.2	GB/T10193-1997, GB/T10194-1997	GB8898-2011, GB4943.1-2011
E314979	J50411784		5944		现行证书号: CQC03001005165 CQC03001007654 新证书号: (见备注) CQC18001199842 CQC18001198951		
TVR14180	√	√		√		√	
TVR14220	√	√		√		√	
TVR14270	√	√		√		√	
TVR14330	√	√		√		√	
TVR14390	√	√		√		√	
TVR14470	√	√		√		√	
TVR14560	√	√		√		√	
TVR14680	√	√		√		√	
TVR14820	√	√		√		√	
TVR14101	√	√		√		√	
TVR14121	√	√		√		√	
TVR14151	√	√		√		√	
TVR14181	√	√	√	√	√	√	
TVR14201	√	√	√	√	√	√	√
TVR14221	√	√	√	√	√	√	√
TVR14241	√	√	√	√	√	√	√
TVR14271	√	√	√	√	√	√	√
TVR14301	√	√	√	√	√	√	√
TVR14331	√	√	√	√	√	√	√
TVR14361	√	√	√	√	√	√	√
TVR14391	√	√	√	√	√	√	√
TVR14431	√	√	√	√	√	√	√
TVR14471	√	√	√	√	√	√	√
TVR14511	√	√	√	√	√	√	√
TVR14561	√	√	√	√	√	√	√
TVR14621	√	√	√	√	√	√	√
TVR14681	√	√	√	√	√	√	√
TVR14751	√	√	√	√	√	√	√
TVR14821	√	√	√	√	√	√	√
TVR14911	√	√	√	√	√	√	√
TVR14102	√	√	√	√	√	√	√
TVR14112	√	√	√	√	√	√	√
TVR14122	√	√	√	√	√	√	√
TVR14142	√	√	√	√	√	√	√
TVR14162	√	√	√	√	√	√	√
TVR14182	√	√	√	√	√	√	√

备注:  
 1. CQC现行证书号只会保留至2019/12/31,于2020/1/1开始只有保留新证书号,请使用新证书号做为案件的申请  
 2. UL/cUL/TUV/CQC证书: 操作温度范围是105°C  
 VDE证书: 操作温度范围是85°C; 105°C规格正在申请中

# 氧化锌压敏电阻器：TVR 系列

## 浪涌保护用插件型



安规认证型号	认证机构						
	UL1449 4 <sup>th</sup> & cUL	EN/IEC 61051-1, IEC 61051-2, IEC 61051-2-2	IEC/EN 60950-1 Annex Q IEC/EN 62368-1 Annex G.8.2	EN/IEC 61051-1, IEC 61051-2, IEC 61051-2-2	IEC/EN 62368-1 Annex G.8.2	GB/T10193-1997 GB/T10194-1997	GB8898-2011 GB4943.1-2011
E314979	J50411784		5944		现行证书号: CQC03001005165 CQC03001007654 新证书号: (见备注) CQC18001199807 CQC18001198952		
TVR20180	√	√		√		√	
TVR20220	√	√		√		√	
TVR20270	√	√		√		√	
TVR20330	√	√		√		√	
TVR20390	√	√		√		√	
TVR20470	√	√		√		√	
TVR20560	√	√		√		√	
TVR20680	√	√		√		√	
TVR20820	√	√		√		√	
TVR20101	√	√		√		√	
TVR20121	√	√		√		√	
TVR20151	√	√		√		√	
TVR20181	√	√	√	√	√	√	
TVR20201	√	√	√	√	√	√	√
TVR20221	√	√	√	√	√	√	√
TVR20241	√	√	√	√	√	√	√
TVR20271	√	√	√	√	√	√	√
TVR20301	√	√	√	√	√	√	√
TVR20331	√	√	√	√	√	√	√
TVR20361	√	√	√	√	√	√	√
TVR20391	√	√	√	√	√	√	√
TVR20431	√	√	√	√	√	√	√
TVR20471	√	√	√	√	√	√	√
TVR20511	√	√	√	√	√	√	√
TVR20561	√	√	√	√	√	√	√
TVR20621	√	√	√	√	√	√	√
TVR20681	√	√	√	√	√	√	√
TVR20751	√	√	√	√	√	√	√
TVR20821	√	√	√	√	√	√	√
TVR20911	√	√	√	√	√	√	√
TVR20102	√	√	√	√	√	√	√
TVR20112	√	√	√	√	√	√	√
TVR20122	√	√	√	√	√	√	√
TVR20142	√	√	√	√	√	√	√
TVR20162	√	√	√	√	√	√	√
TVR20182	√	√	√	√	√	√	√

备注:  
 1. CQC现行证书号只会保留至2019/12/31,于2020/1/1开始只有保留新证书号,请使用新证书号做为案件的申请  
 2. UL/cUL/TUV/CQC 证书: 操作温度范围是105°C  
 VDE证书: 操作温度范围是85°C; 105°C规格正在申请中

# 氧化锌压敏电阻：TVR 系列

## 浪涌保护用插件型



### ■ 功率减额曲线

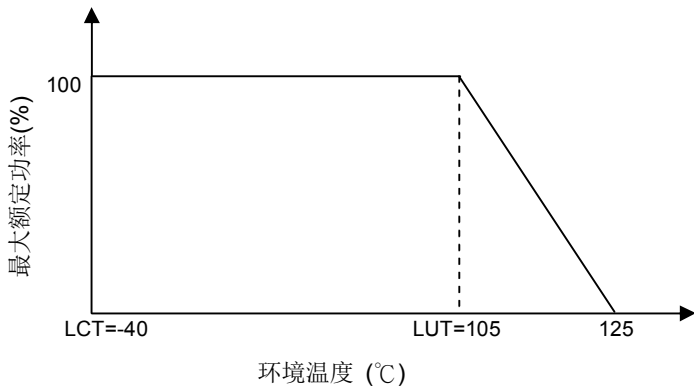

### ■ 冲击电流标准波形

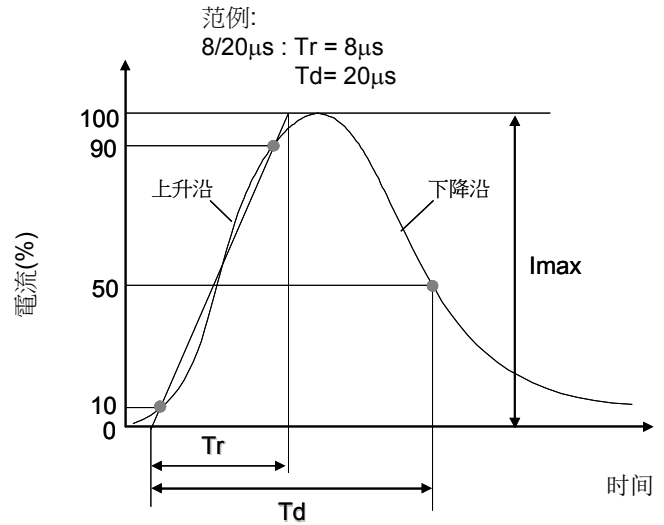

### ■ 最大冲击电流减额曲线

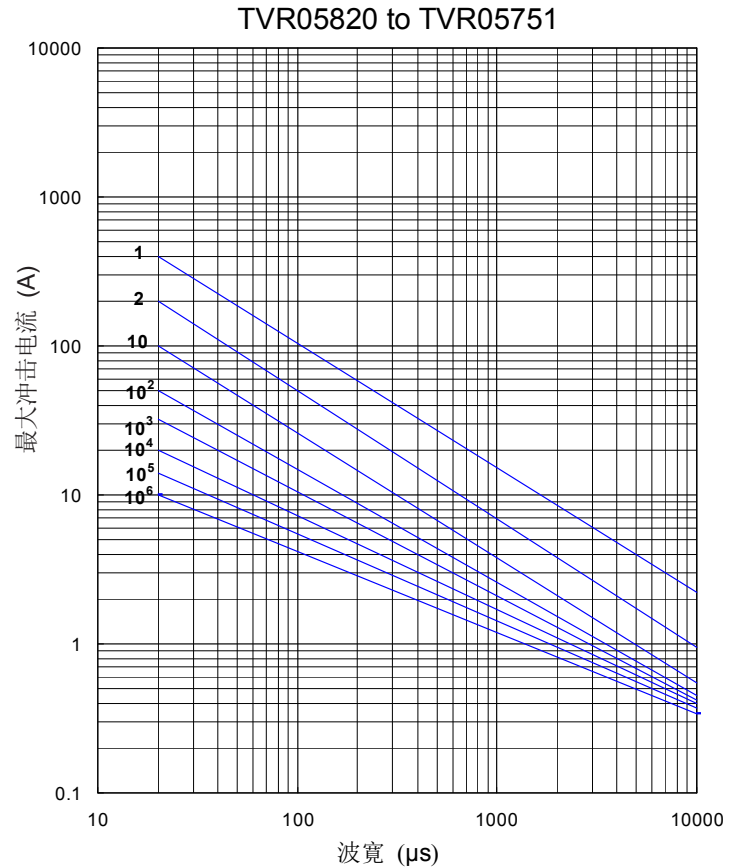
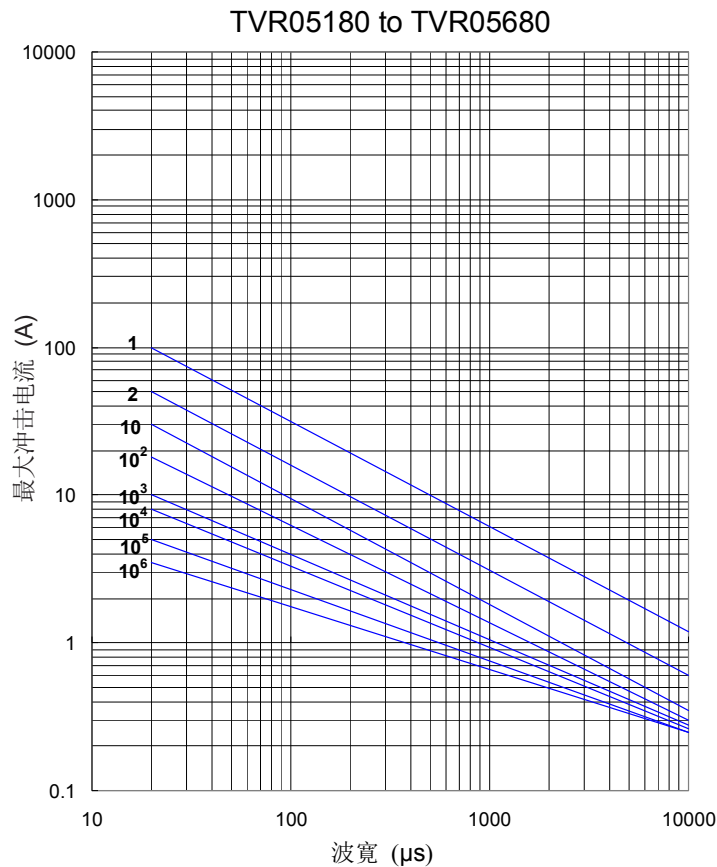

# 氧化锌压敏电阻：TVR 系列

## 浪涌保护用插件型



### 最大冲击电流减额曲线

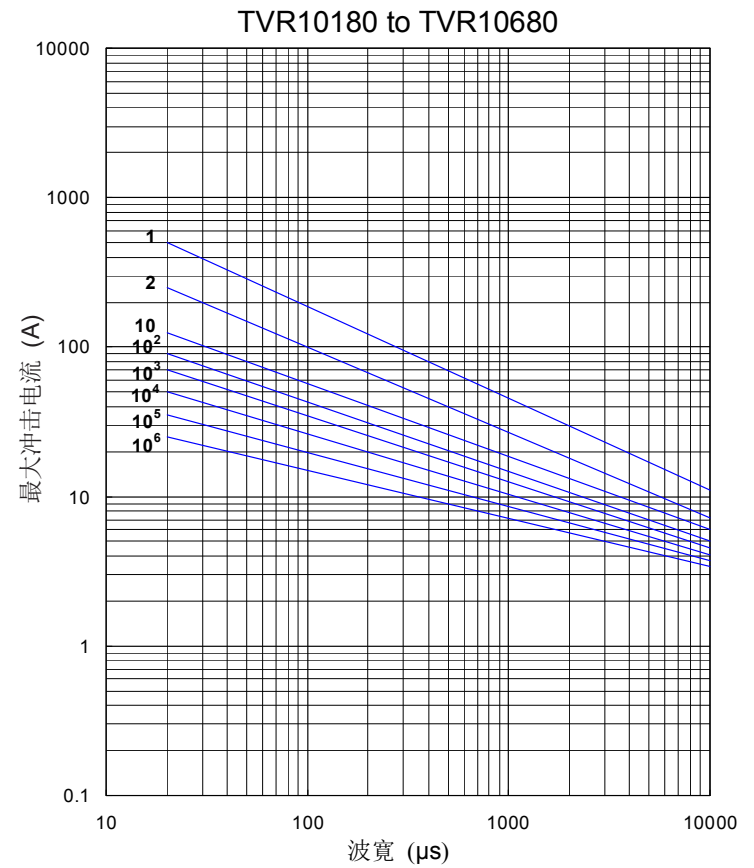
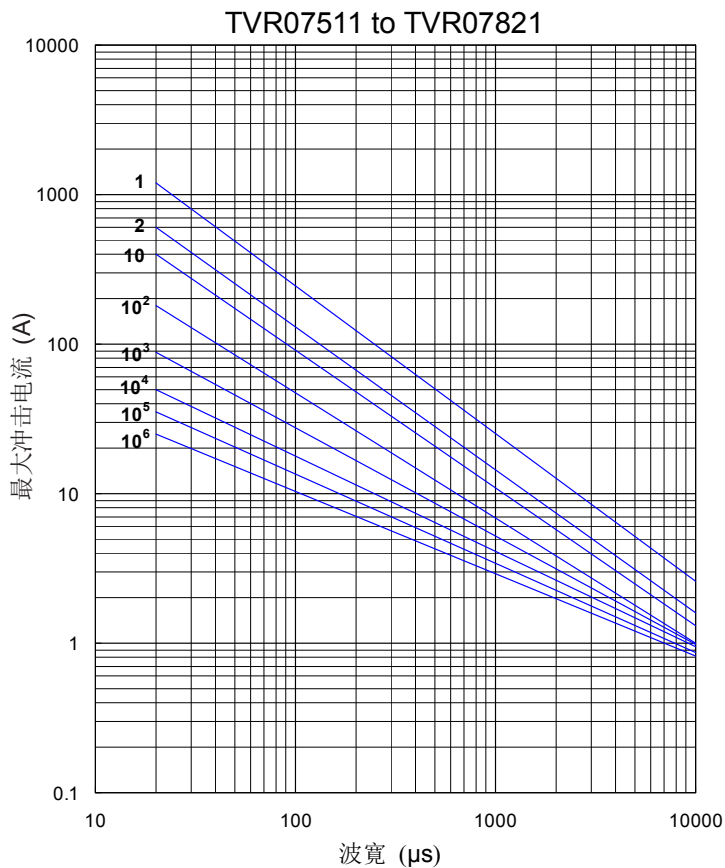
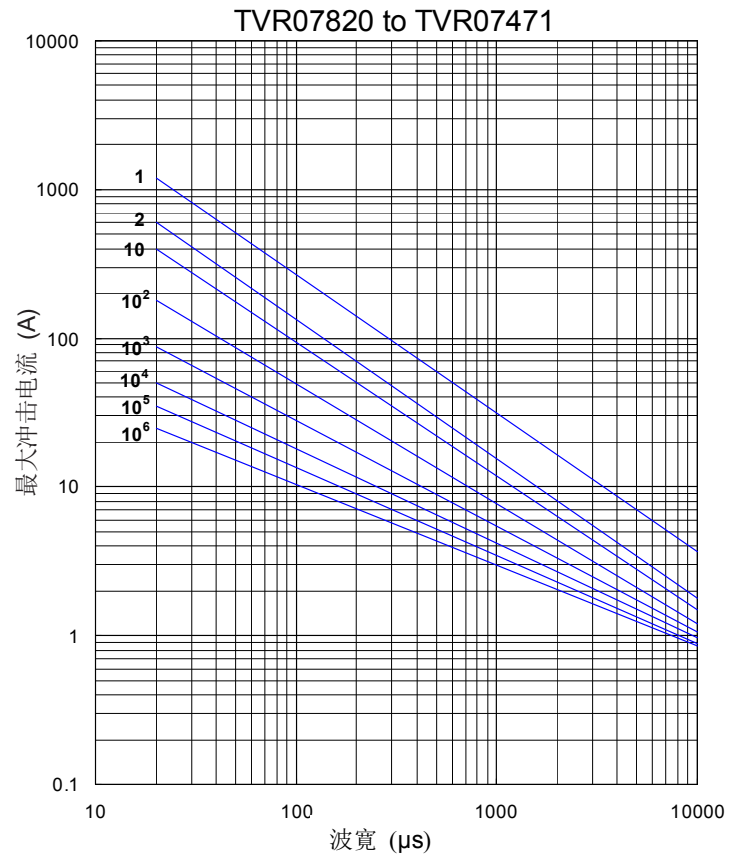
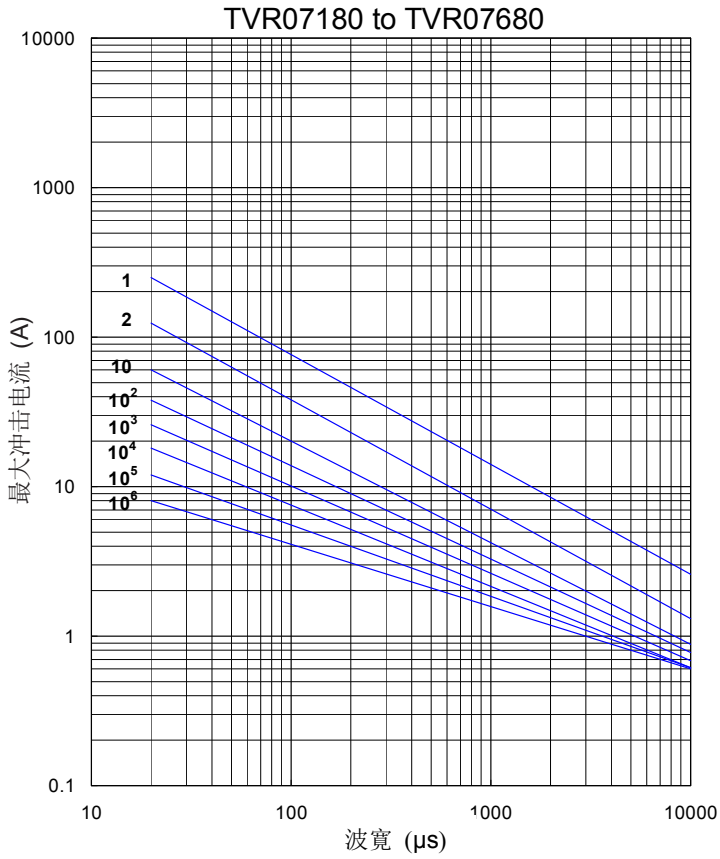

# 氧化锌压敏电阻：TVR 系列 浪涌保护用插件型



## 最大冲击电流减额曲线

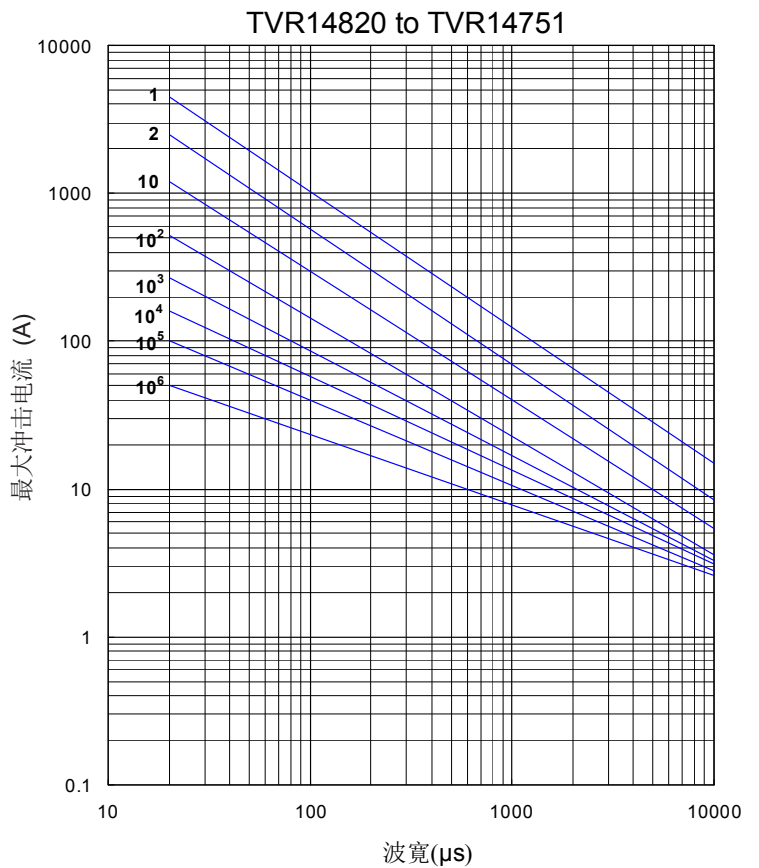
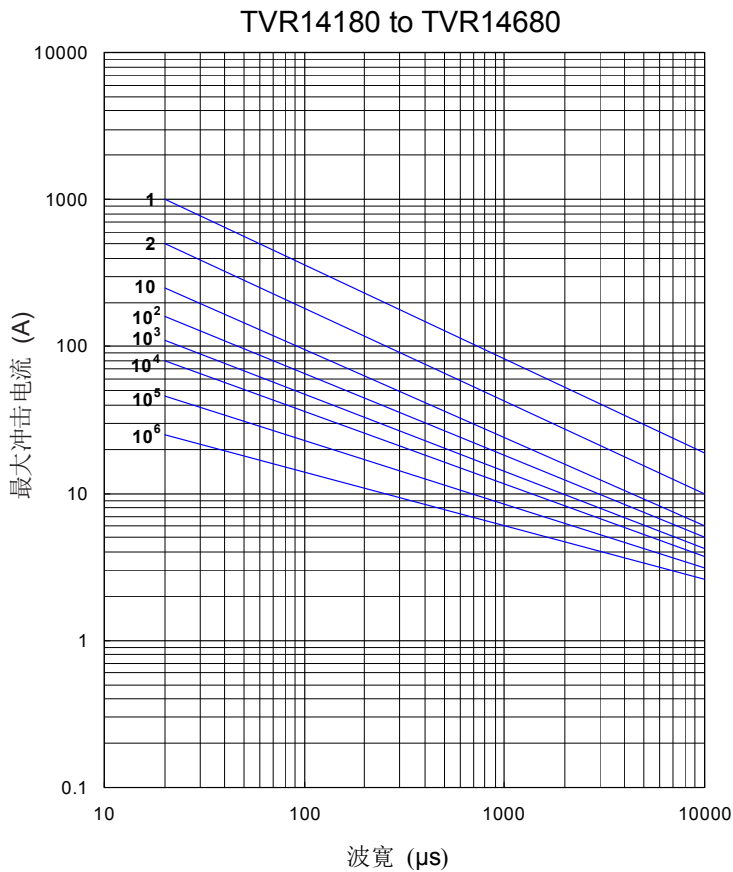
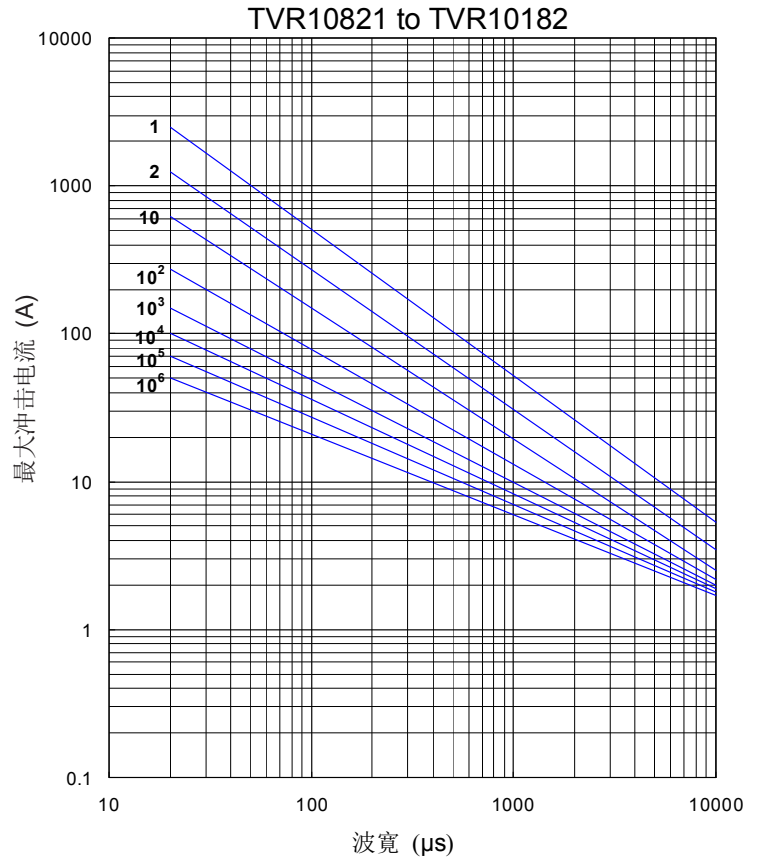
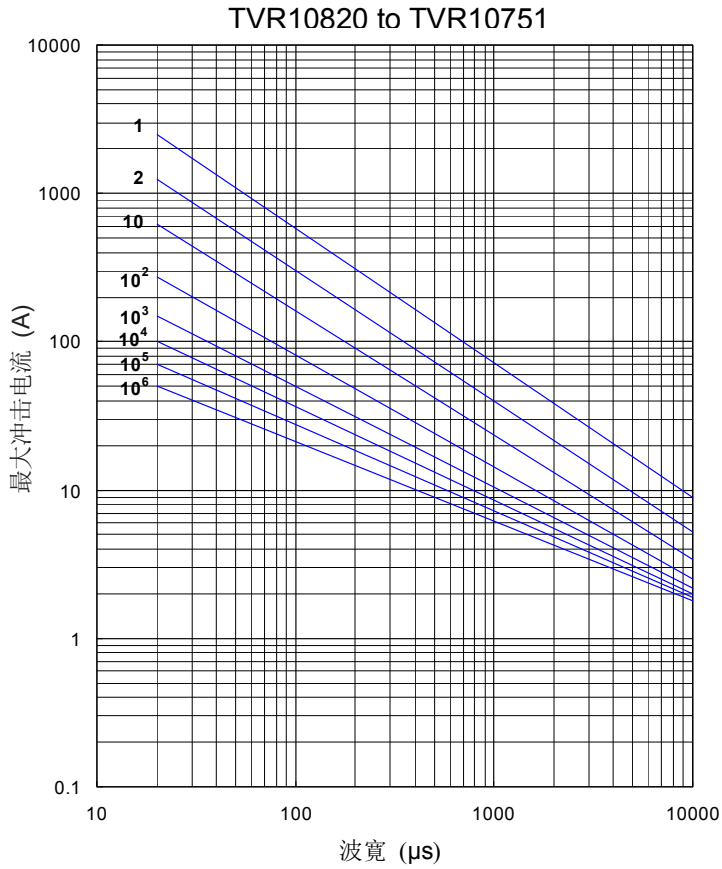



# 氧化锌压敏电阻：TVR 系列

## 浪涌保护用插件型



### 最大冲击电流减额曲线

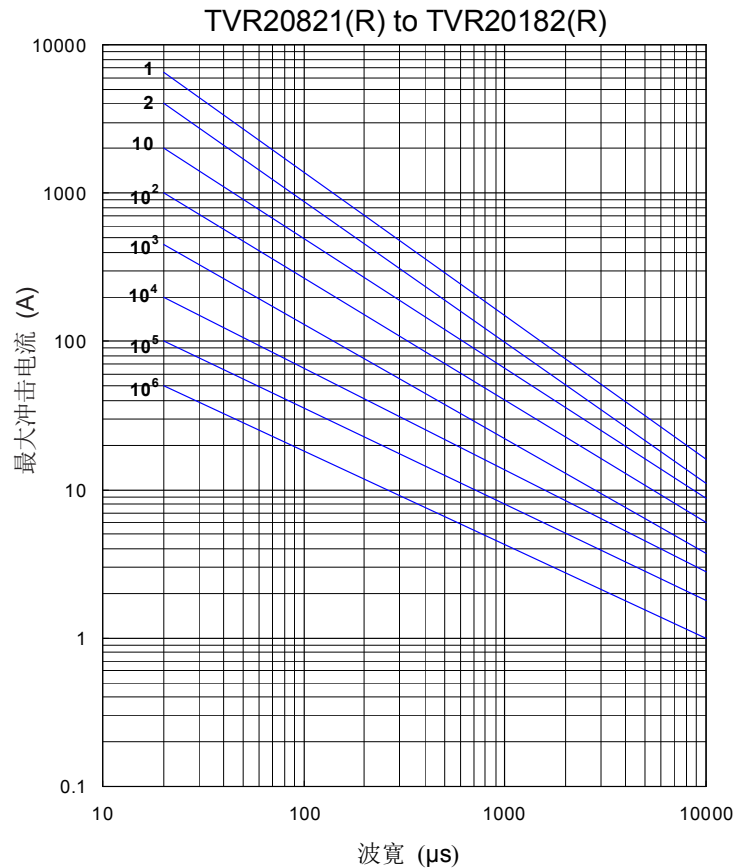
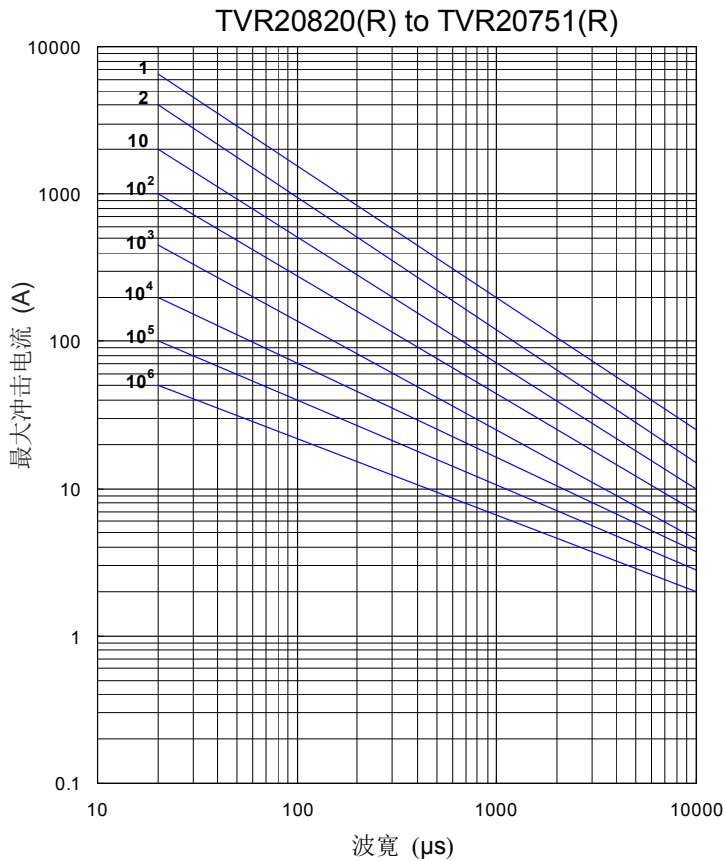
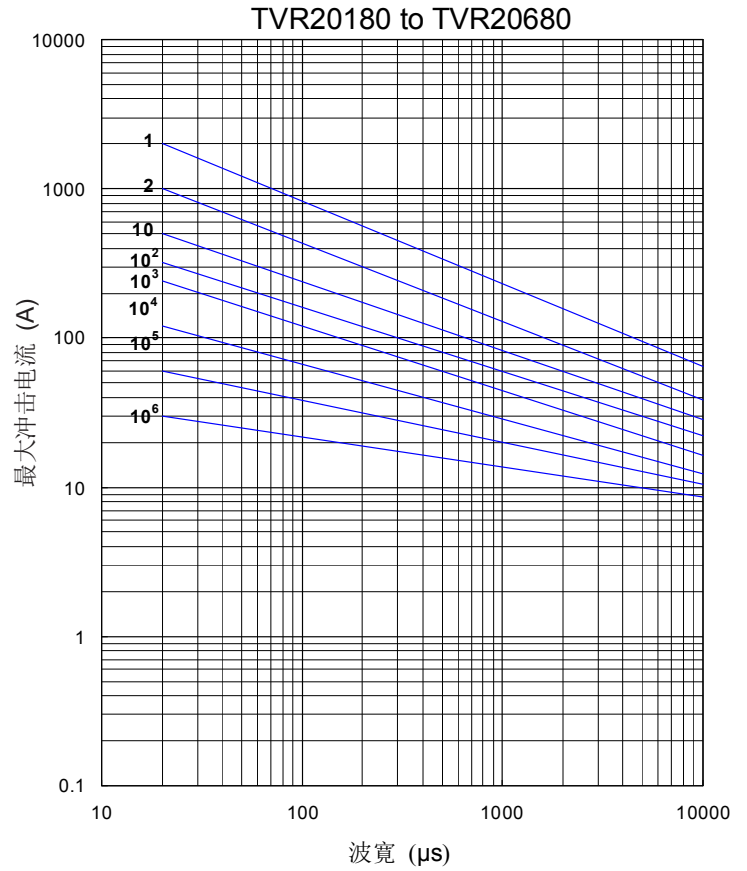
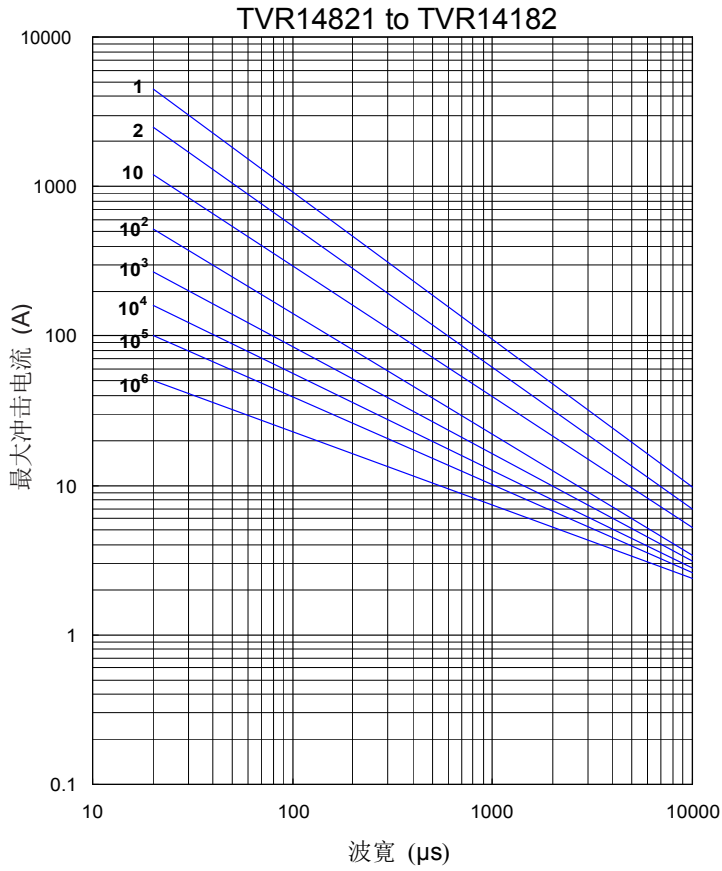

# 氧化锌压敏电阻器：TVR 系列

## 浪涌保护用插件型



### 最大漏电流与最大限制电压曲线

最大漏电流与最大限制电压曲线 (TVR05180 to TVR05680)

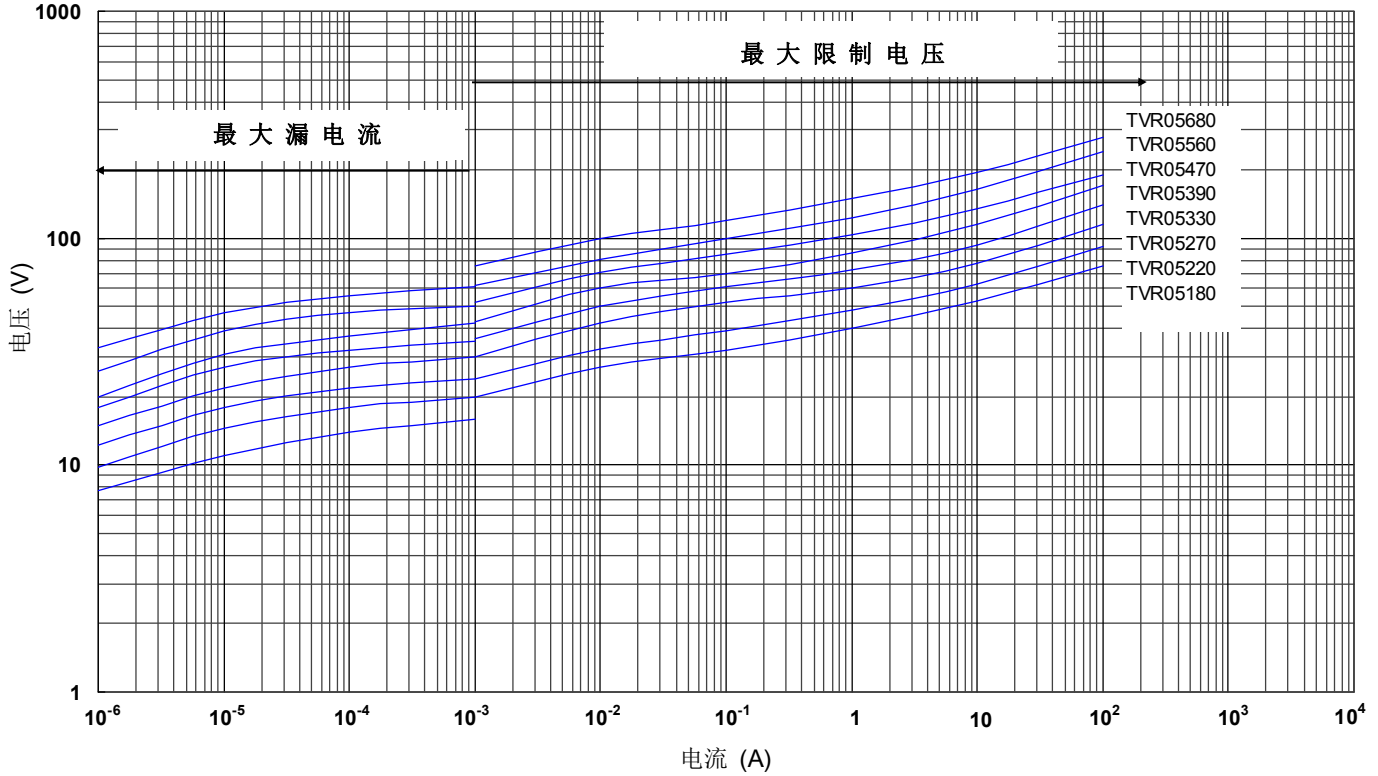

最大漏电流与最大限制电压曲线 (TVR05820 to TVR05751)

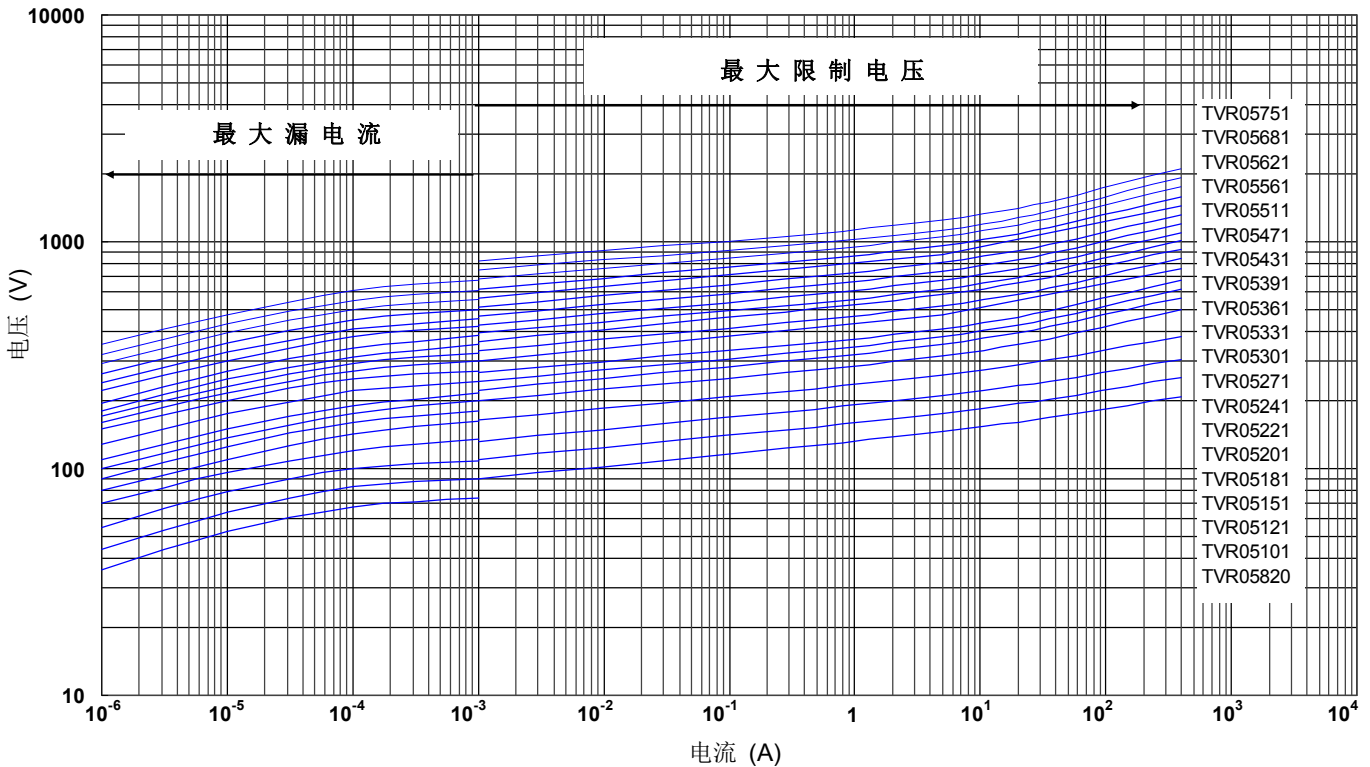

# 氧化锌压敏电阻器：TVR 系列

## 浪涌保护用插件型



### 最大漏电流与最大限制电压曲线

最大漏电流与最大限制电压曲线 (TVR07180 to TVR07680)

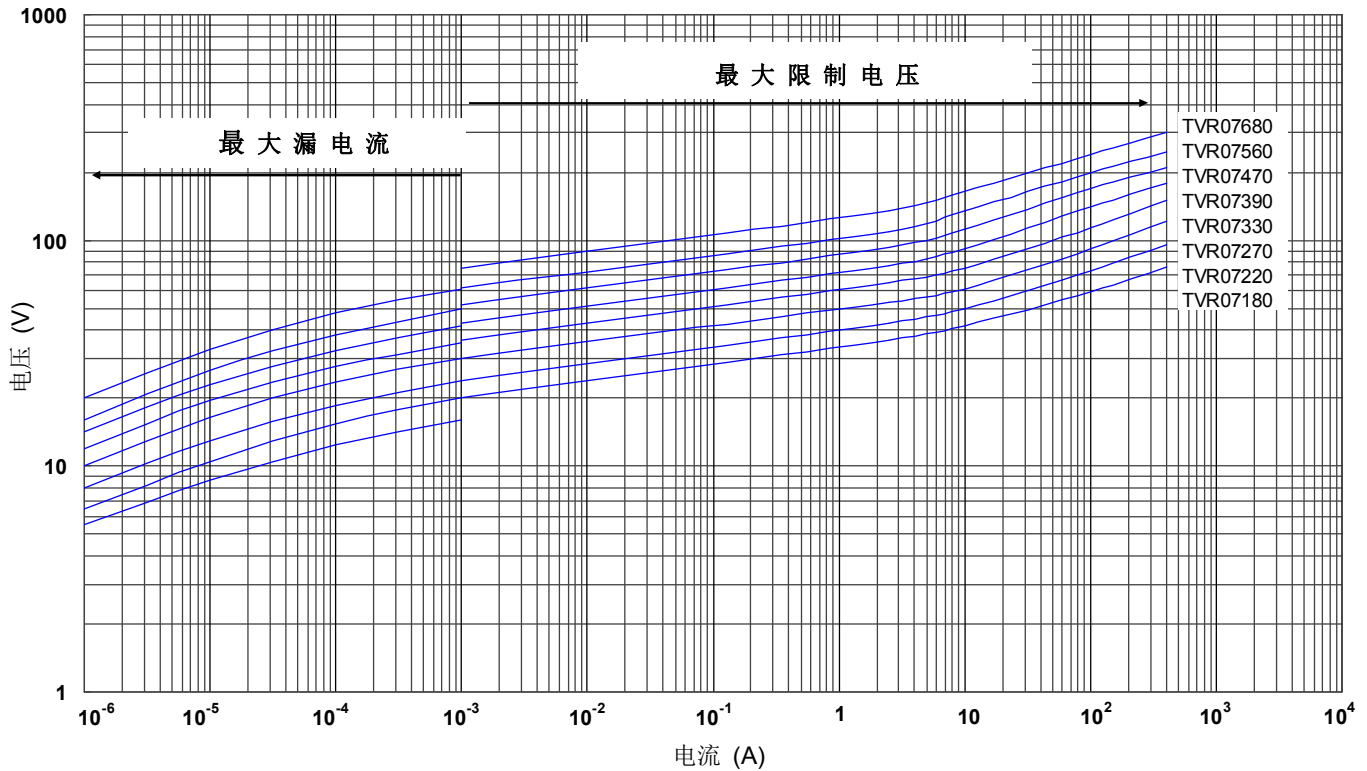

最大漏电流与最大限制电压曲线 (TVR07820 to TVR07471)

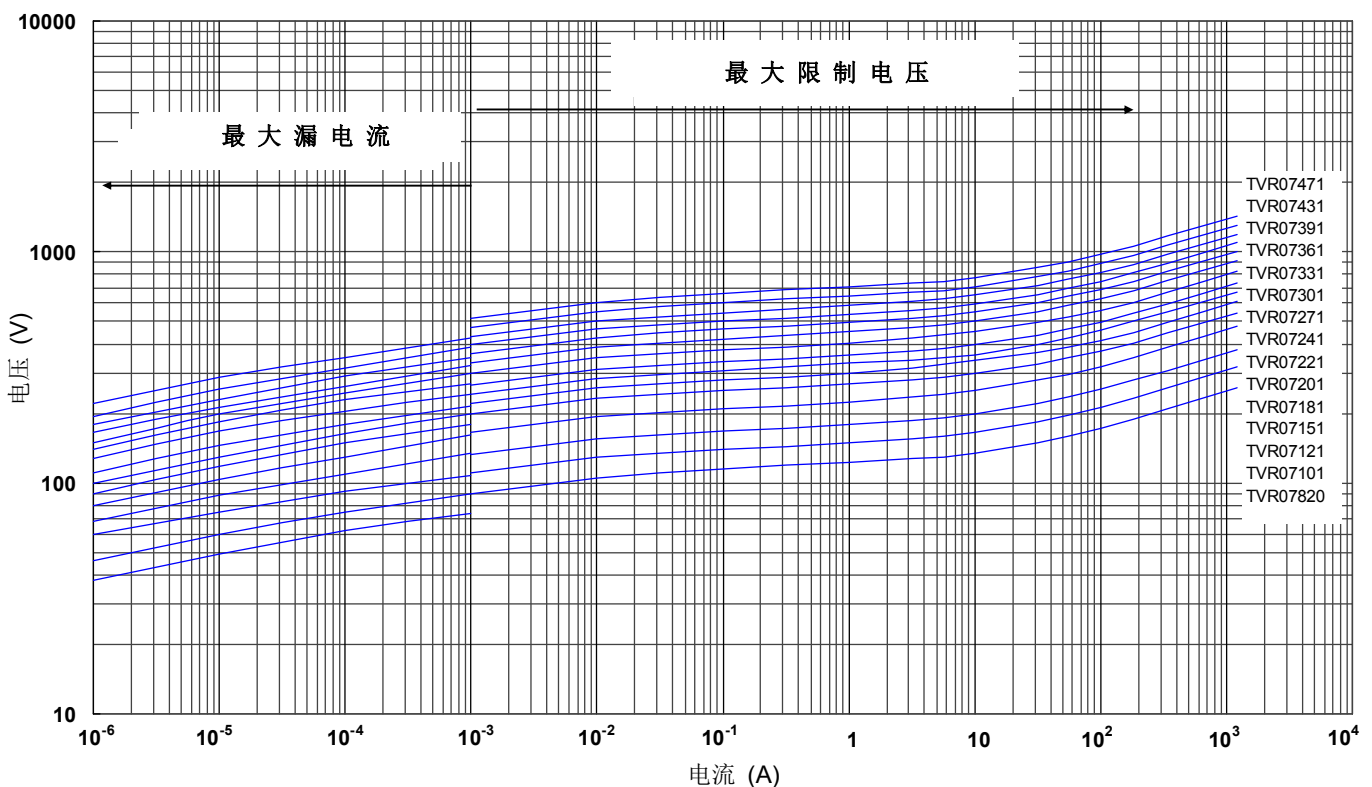

# 氧化锌压敏电阻器：TVR 系列

## 浪涌保护用插件型



### 最大漏电流与最大限制电压曲线

最大漏电流与最大限制电压曲线 (TVR07511 to TVR07821)

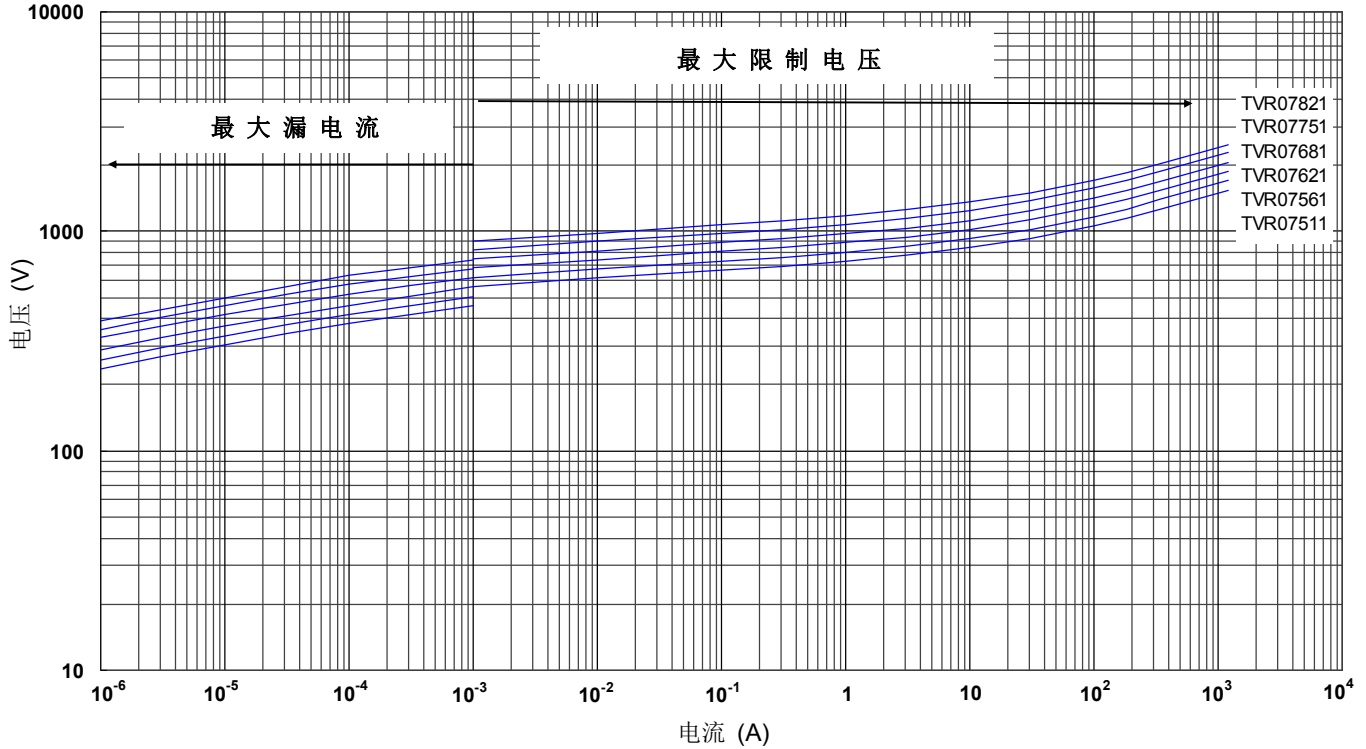

最大漏电流与最大限制电压曲线 (TVR10180 to TVR10680)

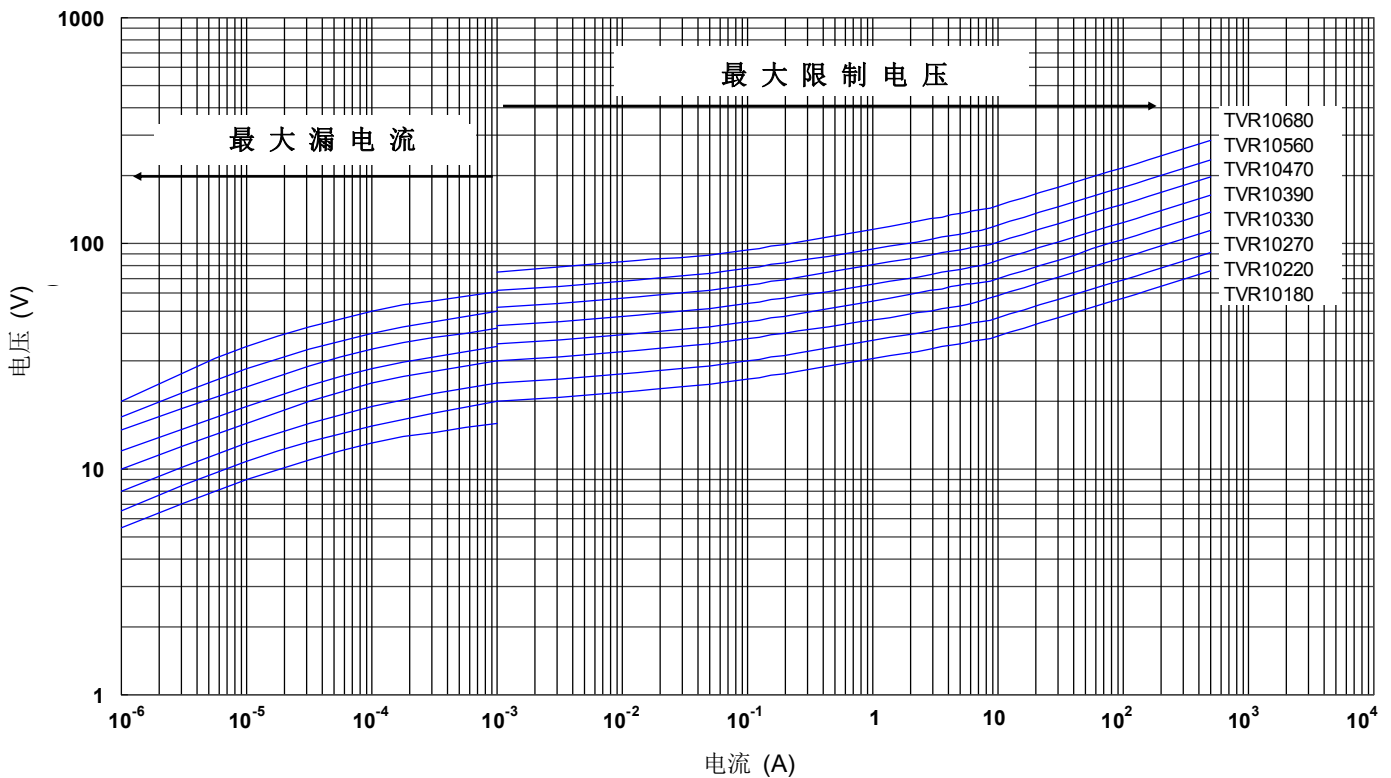

# 氧化锌压敏电阻：TVR 系列

## 浪涌保护用插件型



### 最大漏电流与最大限制电压曲线

最大漏电流与最大限制电压曲线 (TVR10820 to TVR10471)

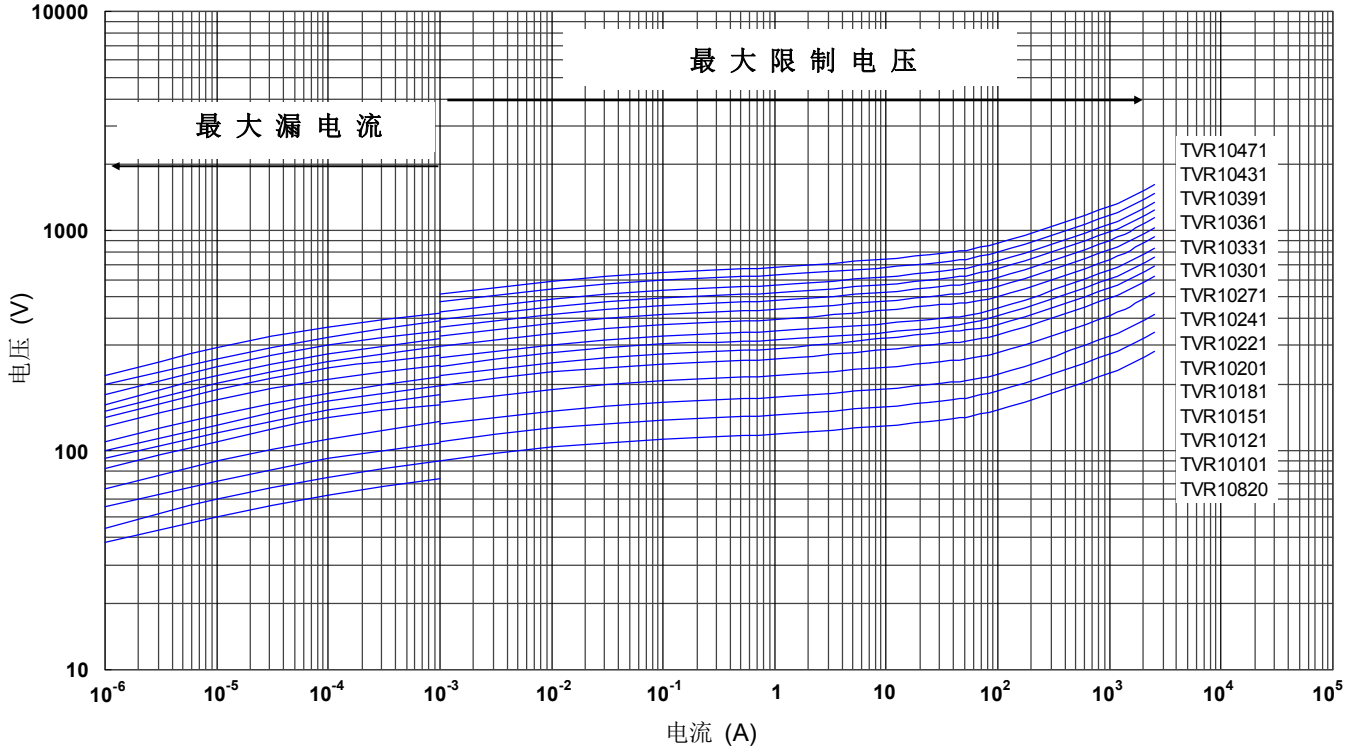

最大漏电流与最大限制电压曲线 (TVR10511 to TVR10182)

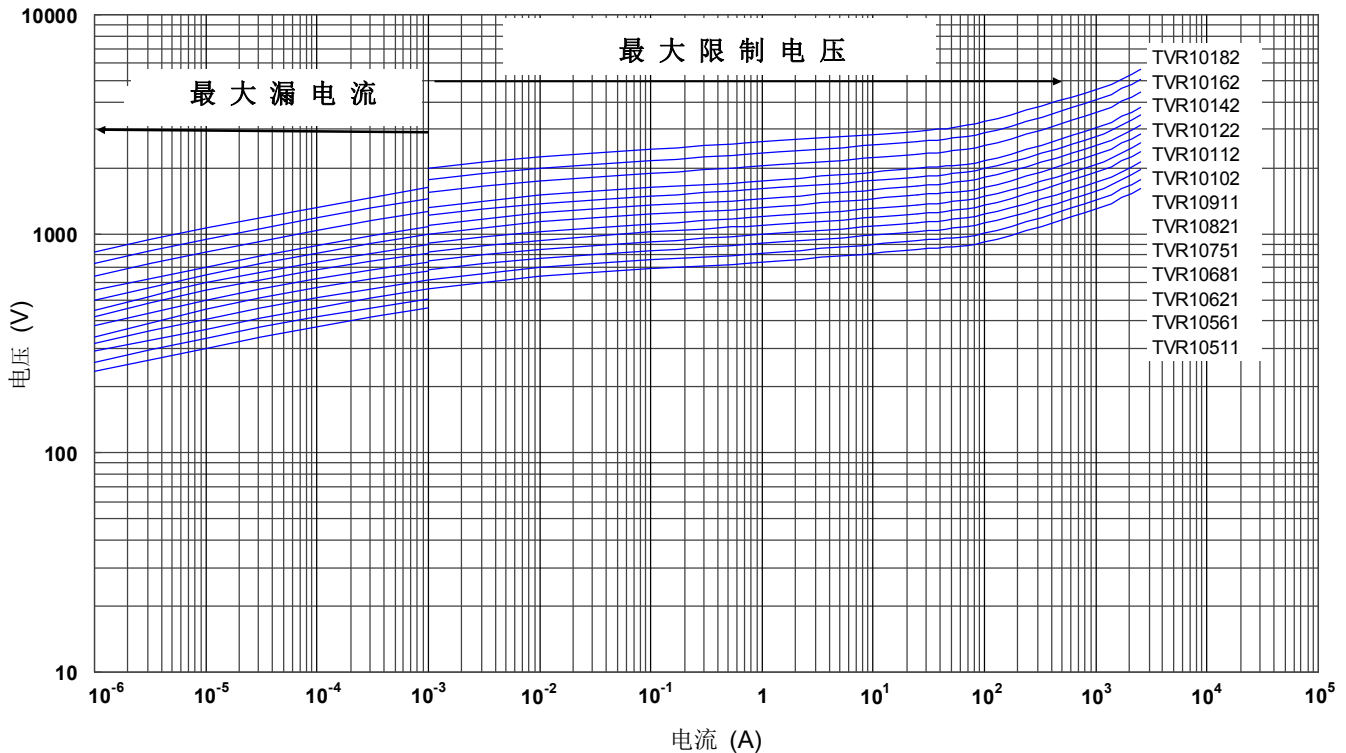

# 氧化锌压敏电阻器：TVR 系列

## 浪涌保护用插件型



### 最大漏电流与最大限制电压曲线

最大漏电流与最大限制电压曲线 (TVR14180 to TVR14680)

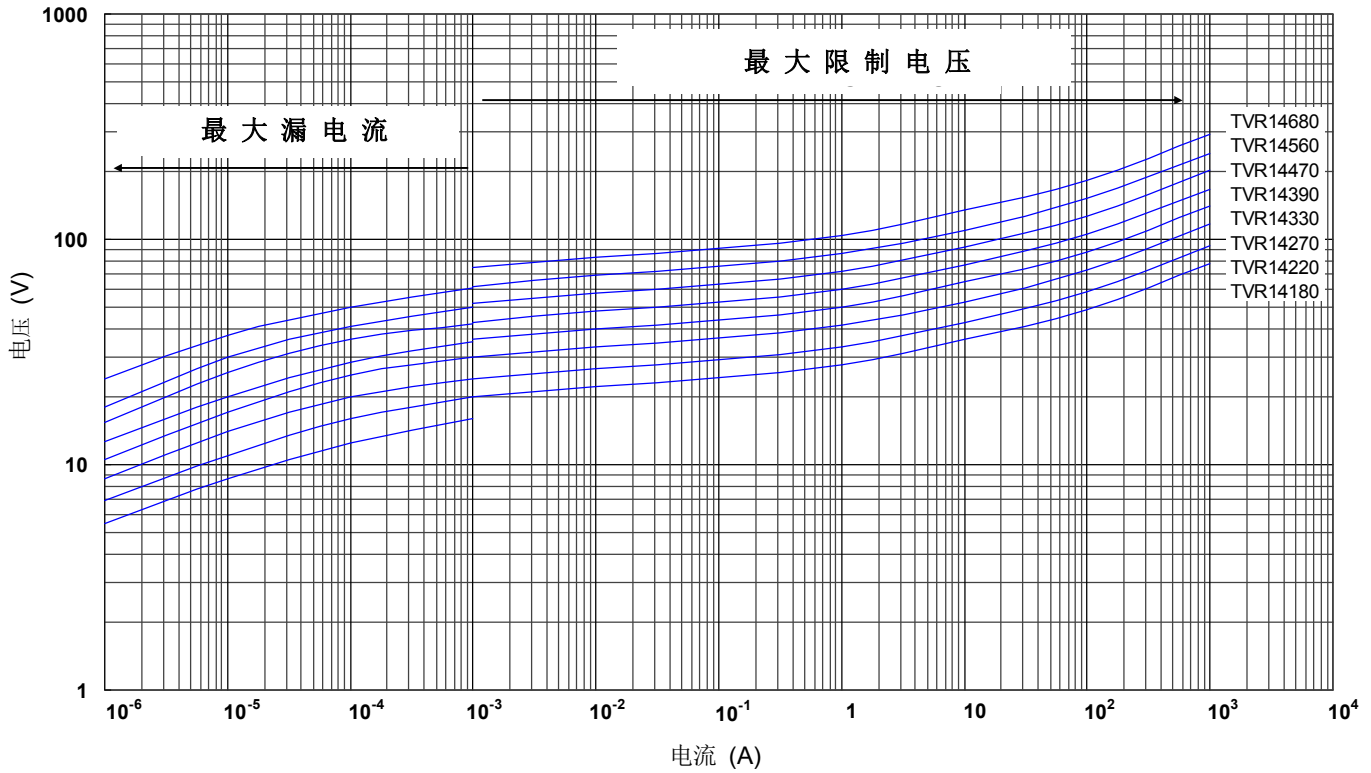

最大漏电流与最大限制电压曲线 (TVR14820 to TVR14471)

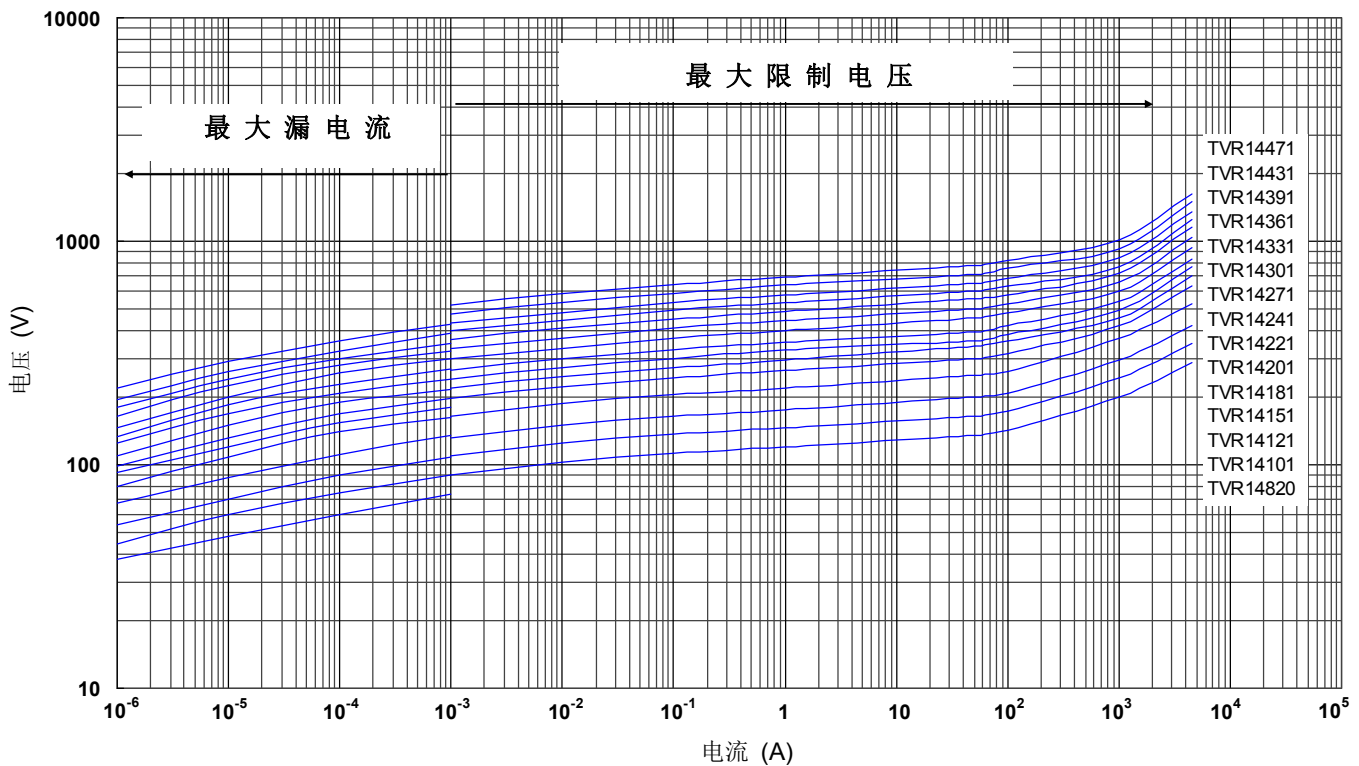

# 氧化锌压敏电阻：TVR 系列

## 浪涌保护用插件型



### 最大漏电流与最大限制电压曲线

最大漏电流与最大限制电压曲线 (TVR14511 to TVR14182)

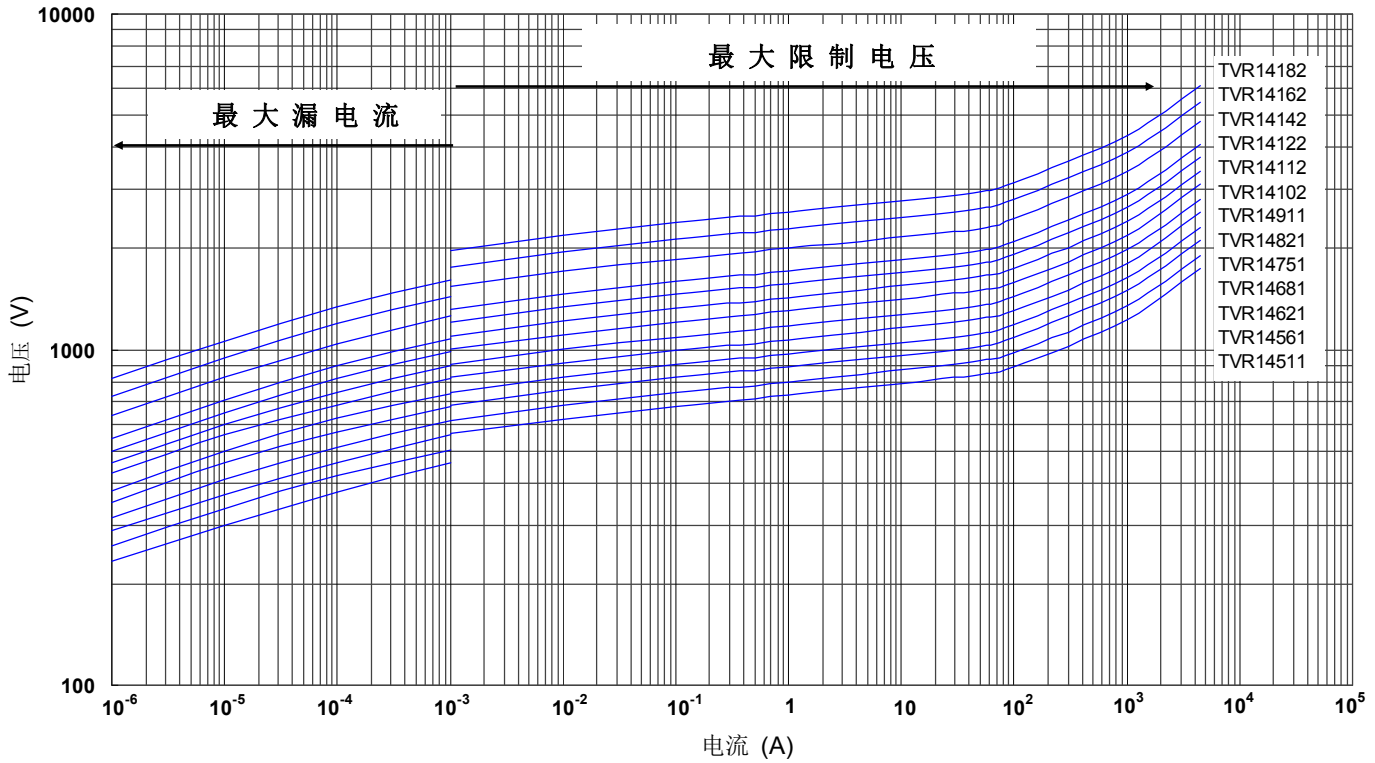

最大漏电流与最大限制电压曲线 (TVR20180 to TVR20680)

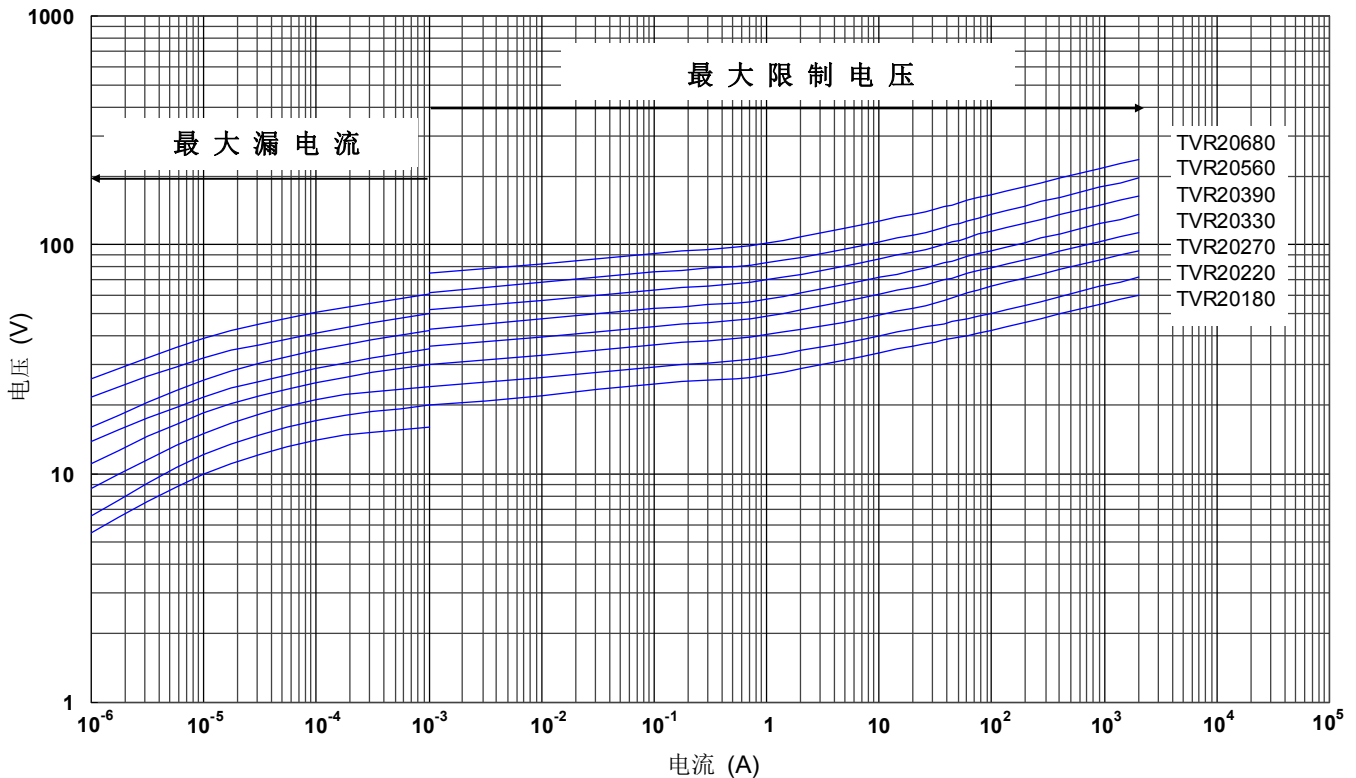

# 氧化锌压敏电阻：TVR 系列

## 浪涌保护用插件型



### 最大漏电流与最大限制电压曲线

最大漏电流与最大限制电压曲线 (TVR20820 to TVR20471)

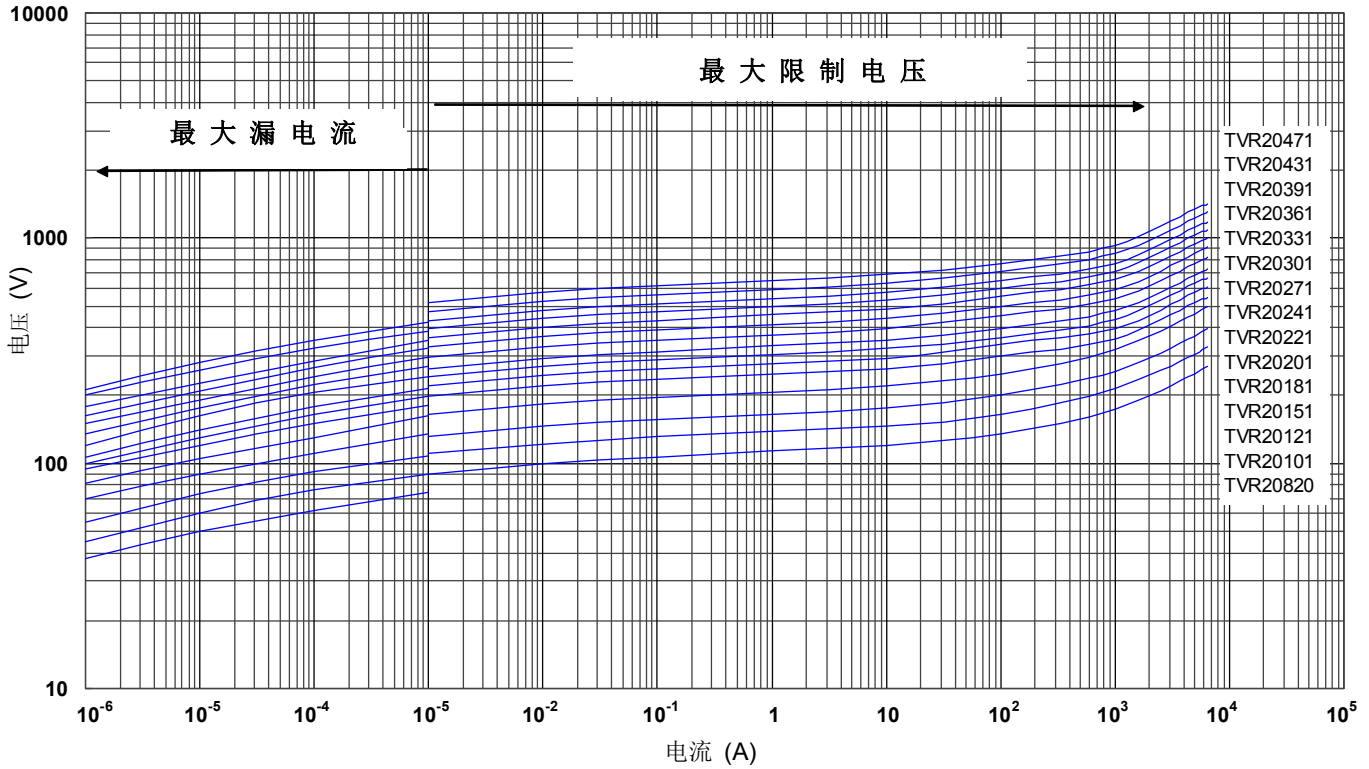

最大漏电流与最大限制电压曲线 (TVR20511 to TVR20182)

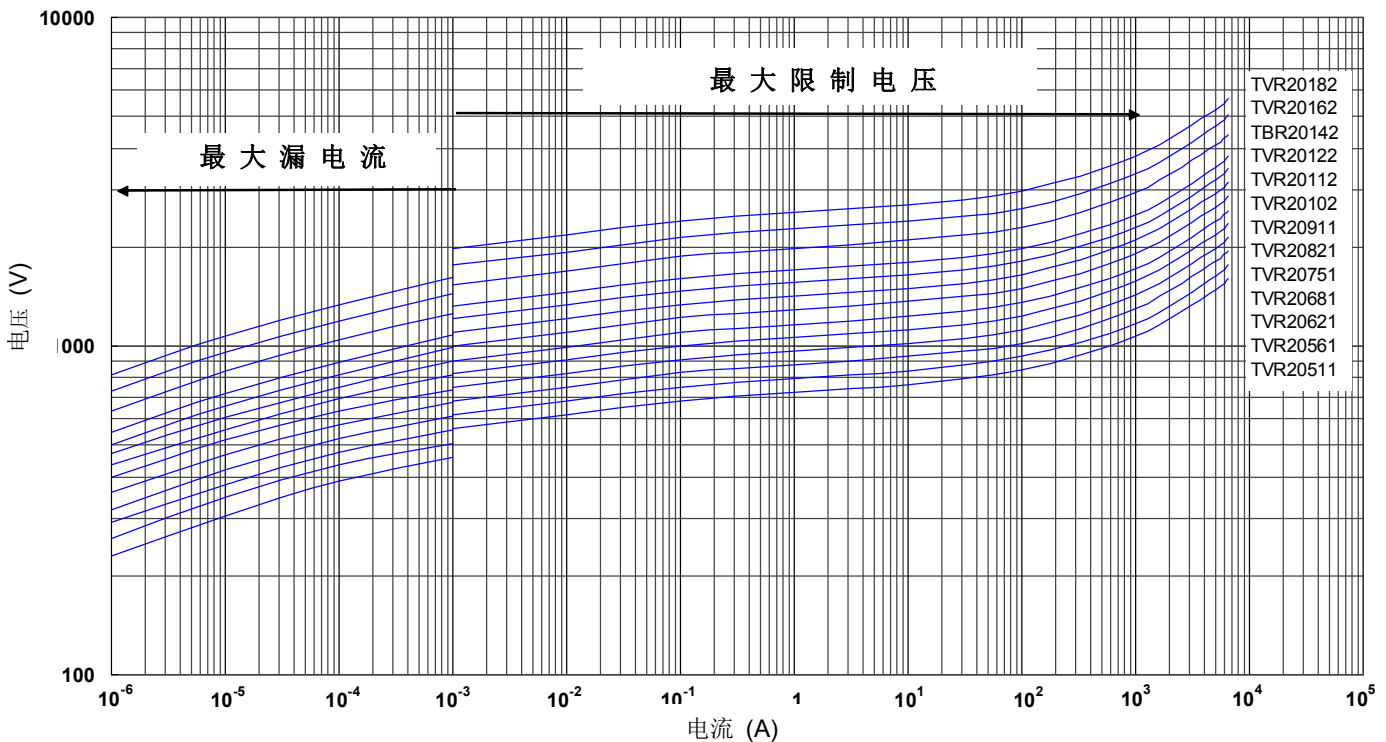



# 氧化锌压敏电阻器：TVR 系列

## 浪涌保护用插件型



### ■ 推荐焊接条件

#### ● 波峰焊曲线

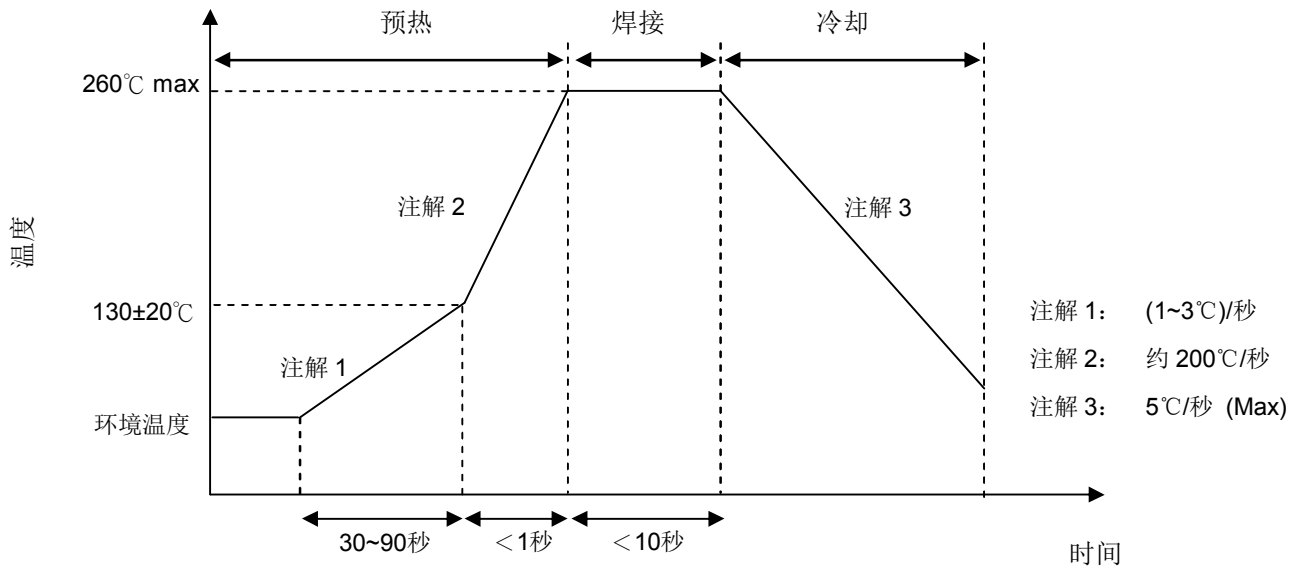

#### ● 烙铁重工焊接条件

项目	条件
烙铁头部温度	360°C (max.)
焊接时间	3 sec (max.)
焊接位置与涂装层距离	2 mm (min.)

# 氧化锌压敏电阻器：TVR 系列

## 浪涌保护用插件型



### ■ 可靠性

试验项目	测试标准	试验条件/方法	性能要求															
引线拉力试验	IEC 60068-2-21	渐近的方式施加指定的重量, 并且在固定位置维持 10±1 秒。  <table style="width: 100%; border: none;"> <tr> <td style="text-align: center;">线径 (mm)</td> <td style="text-align: center;">引线直接下拉力 (Kg)</td> </tr> <tr> <td style="text-align: center;">0.5&lt;d≤0.8</td> <td style="text-align: center;">1.0</td> </tr> <tr> <td style="text-align: center;">0.8&lt;d≤1.25</td> <td style="text-align: center;">2.0</td> </tr> </table>	线径 (mm)	引线直接下拉力 (Kg)	0.5<d≤0.8	1.0	0.8<d≤1.25	2.0	$ \Delta V_{1mA} / V_{1mA}  \leq 5\%$ 无外观损伤									
线径 (mm)	引线直接下拉力 (Kg)																	
0.5<d≤0.8	1.0																	
0.8<d≤1.25	2.0																	
引线弯折试验	IEC 60068-2-21	对样品的一条引线加指定的重量, 先向一方向弯折 90°, 再复原到原位。然后反向弯折 90°, 以相同方法进行。  <table style="width: 100%; border: none;"> <tr> <td style="text-align: center;">线径 (mm)</td> <td style="text-align: center;">弯折试验加力 (Kg)</td> </tr> <tr> <td style="text-align: center;">0.5&lt;d≤0.8</td> <td style="text-align: center;">0.5</td> </tr> <tr> <td style="text-align: center;">0.8&lt;d≤1.25</td> <td style="text-align: center;">1.0</td> </tr> </table>	线径 (mm)	弯折试验加力 (Kg)	0.5<d≤0.8	0.5	0.8<d≤1.25	1.0	$ \Delta V_{1mA} / V_{1mA}  \leq 5\%$ 无外观损伤									
线径 (mm)	弯折试验加力 (Kg)																	
0.5<d≤0.8	0.5																	
0.8<d≤1.25	1.0																	
振动试验	IEC 60068-2-6	振动频率: 10 ~ 55 Hz 振幅: 0.75mm 或 98 m/s <sup>2</sup> 持续时间: 6 小时(3 x 2 小时)	$ \Delta V_{1mA} / V_{1mA}  \leq 5\%$ 无外观损伤															
可焊性试验	IEC 60068-2-20	245±3°C, 3±0.3 秒	着锡面积≥95%															
耐焊接热试验	IEC 60068-2-20	260±3°C, 10±1 秒 (5±0.5 秒仅适用于 TVR05 系列)	$ \Delta V_{1mA} / V_{1mA}  \leq 5\%$ 无外观损伤															
高温存储试验	IEC 60068-2-2	125±5°C x 1000±24 小时	$ \Delta V_{1mA} / V_{1mA}  \leq 5\%$ 无外观损伤															
稳态湿热试验	IEC 60068-2-78	试验分 a、b 两组: a. 40±2°C, 90 ~ 95 % RH, 1344 小时 b. 40±2°C, 90 ~ 95 % RH, 10% V <sub>DC</sub> , 1344 小时	$ \Delta V_{1mA} / V_{1mA}  \leq 5\%$ 无外观损伤 绝缘阻抗≥100MΩ															
温度急变试验	IEC 60068-2-14	温度急变按下表条件循环五个周期。 <table border="1" style="width: 100%; border-collapse: collapse; text-align: center;"> <thead> <tr> <th>步骤</th> <th>温度(°C)</th> <th>时间(分钟)</th> </tr> </thead> <tbody> <tr> <td>1</td> <td>-40±3</td> <td>30±3</td> </tr> <tr> <td>2</td> <td>室温</td> <td>5±3</td> </tr> <tr> <td>3</td> <td>105±2</td> <td>30±3</td> </tr> <tr> <td>4</td> <td>室温</td> <td>5±3</td> </tr> </tbody> </table>	步骤	温度(°C)	时间(分钟)	1	-40±3	30±3	2	室温	5±3	3	105±2	30±3	4	室温	5±3	$ \Delta V_{1mA} / V_{1mA}  \leq 5\%$ 无外观损伤
步骤	温度(°C)	时间(分钟)																
1	-40±3	30±3																
2	室温	5±3																
3	105±2	30±3																
4	室温	5±3																
高温负荷试验	MIL-STD-202 Method 108	105±2 °C, 1000 ± 24小时, 施加V <sub>DC</sub> 或 V <sub>rms</sub> (最大连续工作电压)	$ \Delta V_{1mA} / V_{1mA}  \leq 10\%$ 无外观损伤															
8/20μs 电流冲击寿命试验	IEC 61051-1	8/20μs 电流波形, 同方向冲击最大冲击电流 10 次(冲击电流对应 10 次的减额值), 间隔时间 30 秒。	$ \Delta V_{1mA} / V_{1mA}  \leq 10\%$ 无外观损伤															
10/1000μs 电流冲击寿命试验	IEC 61051-1	10/1000μs 电流波形, 同方向冲击最大冲击电流 10 次(冲击电流对应 10 次的减额值), 间隔时间 2 分钟。	$ \Delta V_{1mA} / V_{1mA}  \leq 10\%$ 无外观损伤															
耐压试验	IEC 61051-1	金属球法, 2500 V <sub>ac</sub> 1 分钟	无外观损伤															
压敏电压温度系数试验	规格标准	$\frac{V_{1mA \text{ at } 105^\circ\text{C}} - V_{1mA \text{ at } 25^\circ\text{C}}}{V_{1mA \text{ at } 25^\circ\text{C}}} \times \frac{1}{80} \times 100 (\% / ^\circ\text{C})$ $\frac{V_{1mA \text{ at } -40^\circ\text{C}} - V_{1mA \text{ at } 25^\circ\text{C}}}{V_{1mA \text{ at } 25^\circ\text{C}}} \times \frac{1}{65} \times 100 (\% / ^\circ\text{C})$	-0.05 ≤ TC ≤ 0.05 (%/°C)															

# 氧化锌压敏电阻器：TVR 系列

## 浪涌保护用插件型



### ■ 包装

#### ■ 编带包装方式说明

#### S 型 (直脚)

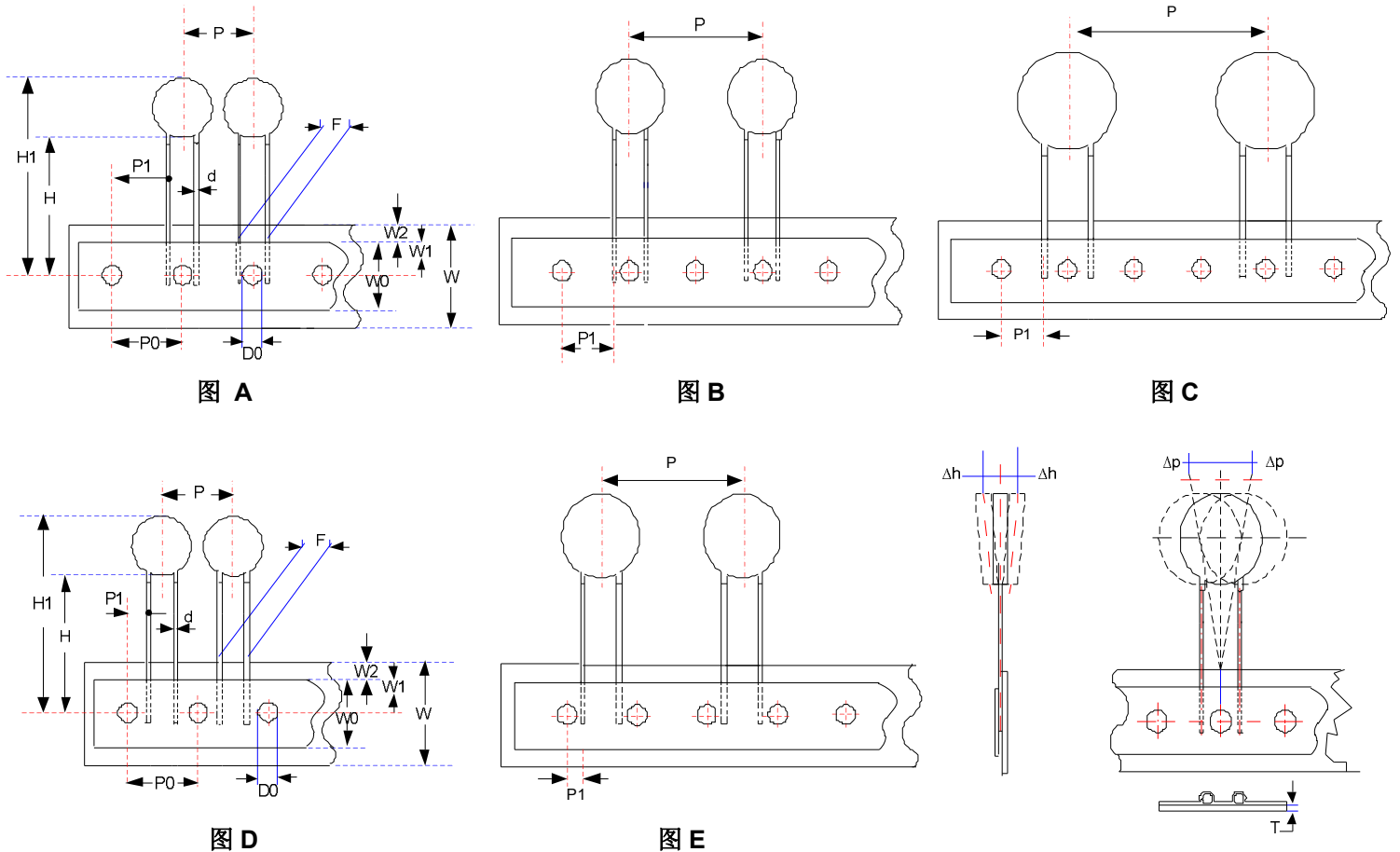

(单位: mm)

编带 代码	本体 尺寸	$P_0$	F	P	$P_1$	H	$H_1$	d	$W_0$	$W_1$	$W_2$	W	$\Delta P$	$\Delta h$	$D_0$	T	图形
		$\pm 0.3$	$\pm 1$	$\pm 1$	$\pm 1$	+2/-0	Max.	$\pm 0.02$	$\pm 1$	+0.75/ -0.5	Max	+1/ -0.5	Max.	Max.	$\pm 0.2$	$\pm 0.2$	
A ( $P_0:12.7$ )	05	12.7	5.0	12.7	3.55	18	28.0	0.6	12	9	3	18	1	2	4	0.6	D
	07	12.7	5.0	12.7	3.55	18	30.0	0.6	12	9	3	18	1	2	4	0.6	D
	10	12.7	7.5	12.7	8.55	18	33.5	0.8	12	9	3	18	1	2	4	0.6	A
	14	12.7	7.5	25.4	8.55	18	38.0	0.8	12	9	3	18	1	2	4	0.6	B
	20	12.7	10.0	38.1	7.20	18	40.5	1.0	12	9	3	18	1	2	4	0.6	C
E ( $P_0:15.0$ )	07	15	5.0	15.0	4.70	18	30.0	0.6	12	9	3	18	1	2	4	0.6	D
	10	15	7.5	15.0	3.35	18	33.5	0.8	12	9	3	18	1	2	4	0.6	D
	14	15	7.5	30.0	3.35	18	38.0	0.8	12	9	3	18	1	2	4	0.6	E
	20	15	10.0	30.0	9.50	18	40.5	1.0	12	9	3	18	1	2	4	0.6	B

# 氧化锌压敏电阻器：TVR 系列

## 浪涌保护用插件型



### F 型 (Y型引脚)

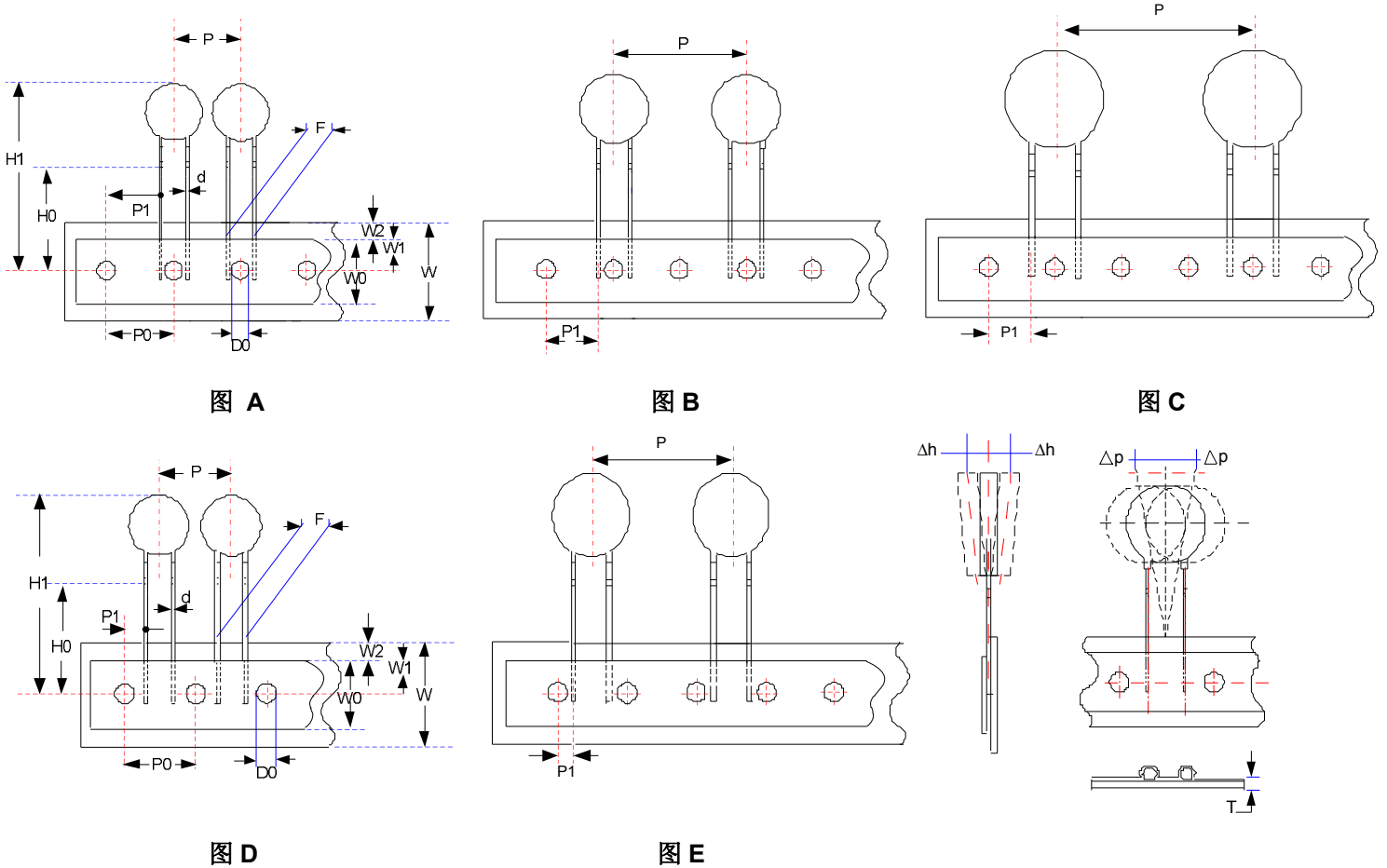

(单位: mm)

编带 代码	本体 尺寸	$P_0$	F	P	$P_1$	$H_0$	$H_1$	d	$W_0$	$W_1$	$W_2$	W	$\Delta P$	$\Delta h$	$D_0$	T	图形
		$\pm 0.3$	$\pm 1$	$\pm 1$	$\pm 0.7$	$\pm 0.5$	Max.	$\pm 0.02$	$\pm 1$	$+0.75/-0.5$	Max	$+1/-0.5$	Max.	Max.	$\pm 0.2$	$\pm 0.2$	
A ( $P_0:12.7$ )	05	12.7	5.0	12.7	3.55	16	28.0	0.6	12	9	3	18	1	2	4	0.6	D
	07	12.7	5.0	12.7	3.55	16	30.0	0.6	12	9	3	18	1	2	4	0.6	D
	10	12.7	7.5	12.7	8.55	16	33.5	0.8	12	9	3	18	1	2	4	0.6	A
	14	12.7	7.5	25.4	8.55	16	38.0	0.8	12	9	3	18	1	2	4	0.6	B
	20	12.7	10.0	38.1	7.20	16	44.5	1.0	12	9	3	18	1	2	4	0.6	C
E ( $P_0:15.0$ )	07	15	5.0	15.0	4.70	16	30.0	0.6	12	9	3	18	1	2	4	0.6	D
	10	15	7.5	15.0	3.35	16	33.5	0.8	12	9	3	18	1	2	4	0.6	D
	14	15	7.5	30.0	3.35	16	38.0	0.8	12	9	3	18	1	2	4	0.6	E
	20	15	10.0	30.0	9.50	16	44.5	1.0	12	9	3	18	1	2	4	0.6	B

# 氧化锌压敏电阻器：TVR 系列

## 浪涌保护用插件型



### ■ 数量

#### ● 散装

系列	直脚型数量 (pcs/袋)	切脚型数量 (pcs/袋)	弯脚型数量 (pcs/袋)
TVR05	250	250	---
TVR07	250	250	200
TVR10 (180~751)	200	200	200
TVR10 (821~182)	100	100	100
TVR14	100	100	100
TVR20	50	50	50

#### ● 卷轴包装

系列	A (mm)	数量 (pcs/卷)
TVR05(180~391)	46	1,500
TVR05(431~751)		1,000
TVR07(180~391)		1,500
TVR07(431~821)		1,000
TVR10(180~911)		1,000
TVR10(102~112)		750
TVR10(122~182)		500
TVR14(180~470)		800
TVR14(560~391)		750
TVR14(431~182)		500
TVR20(180~431)	52	500
TVR20(471~681)		400
TVR20(751~182)		250

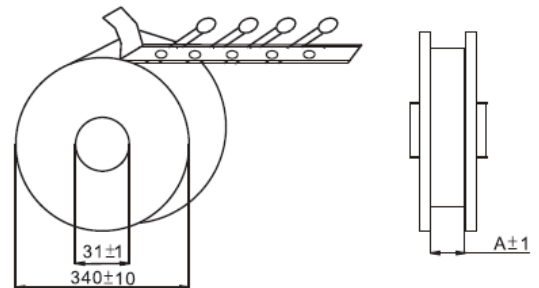

(单位: mm)

# 氧化锌压敏电阻器：TVR 系列 浪涌保护用插件型



## ● 盒装

系列	数量 (pcs/盒)	数量 (pcs/盒)
	P0=12.7mm	P0=15.0mm
TVR05(180~391)	1,500	1,500
TVR05(431~751)	1,200	1,000
TVR07(180~391)	1,500	1,500
TVR07(431~511)	1,200	1,200
TVR07(561~821)	1,000	1,200
TVR10(180~361)	1,200	950
TVR10(391~621)	1,200	750
TVR10(681~112)	800	600
TVR10(122~182)	700	400
TVR14(180~271)	650	500
TVR14(301~561)	500	450
TVR14(621~751)	400	350
TVR14(821~112)	300	300
TVR14(122~182)	300	250
TVR20(180~751)	300	300
TVR20(821~182)	250	250

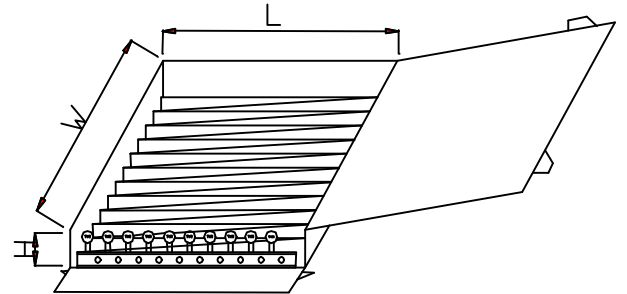

(单位: mm)

系列	W±5	L±5	H±5
TVR05 ~ TVR20	345	275	55

## ■ 仓库存储条件

- 存储条件：
  1. 储存温度：-10°C~+40°C
  2. 相对湿度：≤75%RH
  3. 不要将本产品存放在有腐蚀性气体或是阳光直接照射的环境中保管。
- 存储期限：1年

## X-ON Electronics

Largest Supplier of Electrical and Electronic Components

*Click to view similar products for [Varistors](#) category:*

*Click to view products by [TKS](#) manufacturer:*

Other Similar products are found below :

[820443211E](#) [MLV0402E30703T](#) [MLV0603E30403T](#) [B72205S271K111](#) [B72207S350K311](#) [B72207S381K101](#) [B72260B102K1](#)  
[B72260B251K1](#) [B72280B0381K001](#) [B72280B0461K001](#) [B72280B271K1](#) [B72650M0151K093](#) [B72660M0271K093](#) [S10K11G5S5](#) [ERZ-](#)  
[C07DK221U](#) [TND10V-471KB00AAA0](#) [B72205S301K211](#) [B72207S141K111](#) [B72210S271K111](#) [B72214S350K551](#) [B72220P3351K101](#)  
[B72280B0231K001](#) [B72280B112K1](#) [B72280B381K1](#) [B72590D360A60](#) [B72650M0400K072](#) [B72650M0500K072](#) [B72660M0200K072](#)  
[B72660M1300K072](#) [B72670M1140K72](#) [MLV0603E30703T](#) [MLV0603E32503T](#) [TVZ18EC271KBS](#) [TVZ20EB911KBS](#) [TVZ25D201KBS](#)  
[TVZ25D241KBS](#) [419-2080-101](#) [ERZ-V20R201](#) [MLV0805E31103T](#) [MLV0805E30703T](#) [ERZ-V20R221](#) [B72205S350K211](#)  
[B72210P2511K101](#) [B72214S271K501](#) [B72220P3551K101](#) [B72240B681K1](#) [B72650M350K72](#) [TVZ20ECN511KBS](#) [TVZ20EC911KBS](#)  
[TVZ20EBN911KBS](#)