

INDIVIDUAL SPECIFICATION SHEET

Product Name: 1206 Slow Blow SMD Fuses

Part Number: :F12T25

Revision: A



Dongguan TLC Electronic Technology Co., LTD

No.18,5th GaoLi Road,TangXia Town,DongGuan,GuangDong,P.R China 523710

TEL: 86-0769-3892 0511

FAX: 86-0769-8793 2077

Http: www.tlcet.com.cn

Rev.	Effective Date	Changed Contents
A	2021-9-1	New Release

The individual specification sheet are the property of Dongguan TLC electronic technology Co.,Ltd and shall not be copied or used as commercial purposes without permission.

PREPEARED BY

APPROVED BY



Description

F12T Series are the fuses set the industry standard for performance, reliability and quality. The solder-free design provides excellent on-off and temperature cycling characteristics during use and also makes our SMD fuses more heat and shock tolerant than typical subminiature fuses.



Electrical Characteristics					
Rated Current	1.0In	2.5In	3.0In	3.5In	10.0In
25A	4 hour min.	-	-	5 sec max.	0.2ms – 10ms

Features

- High inrush current withstanding capability
- AEC-Q200 Automotive Grade Certified
- Compatible with reflow and wave solder
- Ceramic and glass construction
- Excellent environmental integrity
- One time positive disconnect
- Lead Free and Halogen free material

Specifications

Specification							
Part No.	Rated Voltage DC	Rated Current (A)	Breaking Capacity (A) ¹	Typical Cold Resistance (mOhms) ²	Typical Voltage Drop (mV)	Typical Pre-Arcing I ² t (A ² Sec) ³	Alpha Mark
F12T25	32V	25	150A@32Vdc	1.6	90	60	L

1. DC Interrupting Rating (Measured at rated voltage, time constant of less than 50 microseconds, battery source)
2. DC Cold Resistance are measured at <10% of rated current in ambient temperature of 25°C
3. Typical Pre-arcing I²t are measured at 10In Current
Choice fuse for surge application (USB charger etc.), make sure the I²t of fuse is 4 times than surge.

Dimension

Drawing not to scale (Unit: mm)

Top view

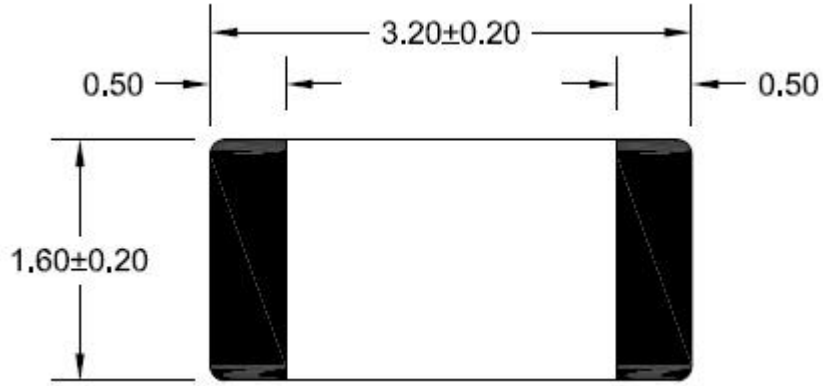

Side view

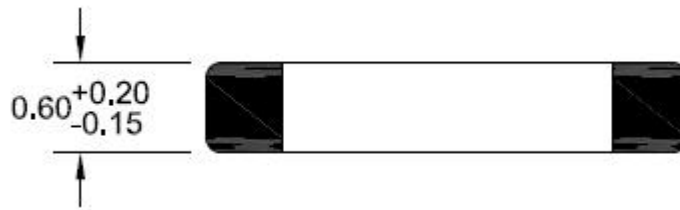

Recommended land pattern

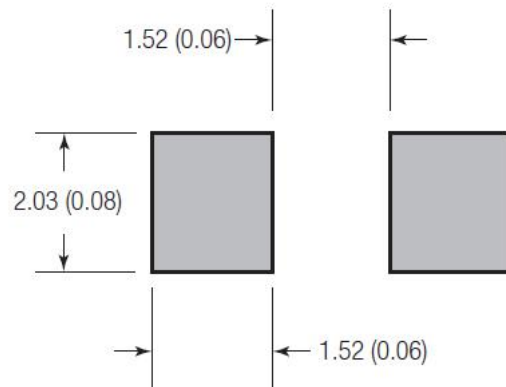

Unit: mm(inch)

Time Current Curve

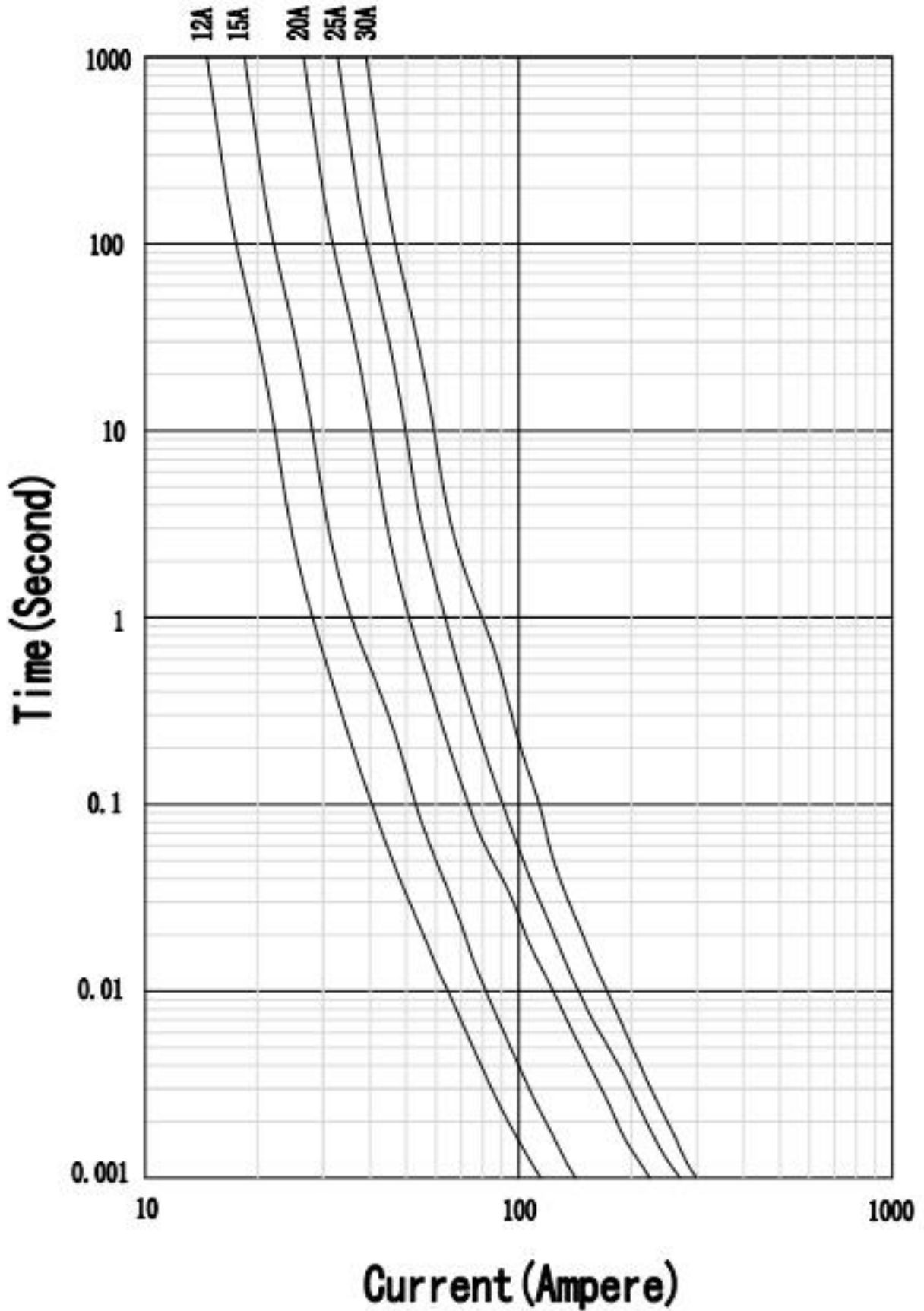

Soldering method

- Wave solder
 - Reservoir temperature: 260°C
 - Time in reservoir: 10 seconds maximum
- Infrared reflow
 - Temperature: 260°C
 - Time: 30 seconds maximum

Solder reflow profile

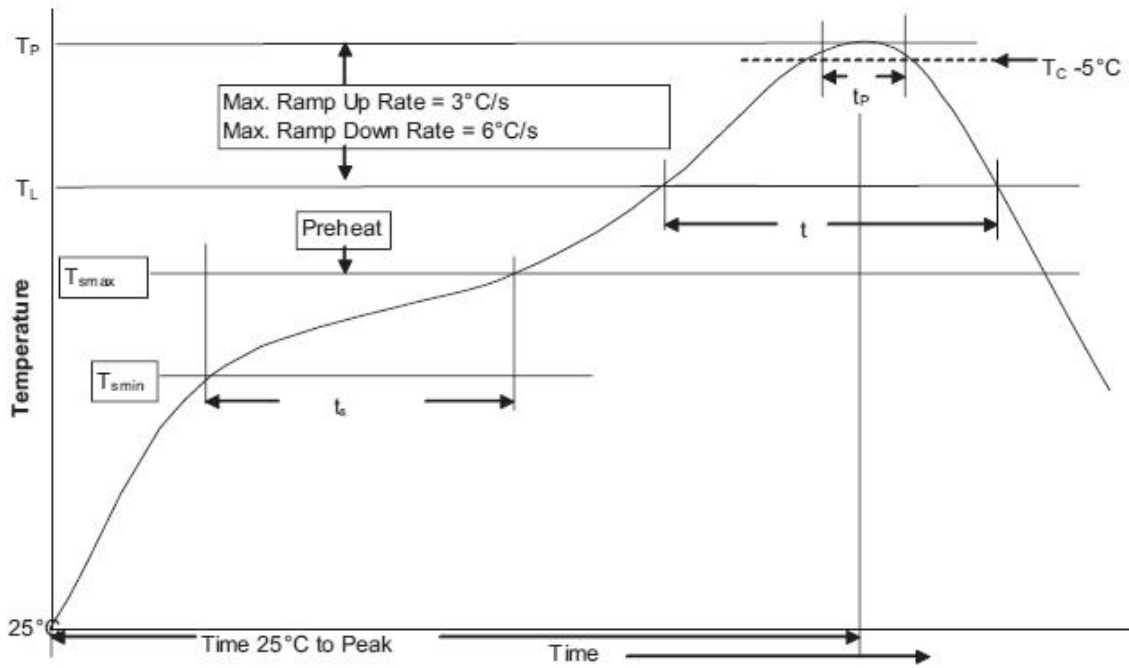

Profile Feature		Lead(Pb) free solder
Preheat and soak	• Temperature min. (T_{smin})	150°C
	• Temperature max. (T_{smax})	200°C
	• Time (T_{smin} to T_{smax}) (t_s)	60 - 120 Seconds
Average ramp up rate T_{smax} to T_P		3°C / Second Max.
Liquidous temperature (T_L)		217°C
Time at liquidous (t_L)		60 - 150 Seconds
Peak package body temperature (T_P)		260°C
Time (t_P) within 5°C of the specified classification temperature (T_C)		30 Seconds
Average ramp-down rate (T_P to T_{smax})		6°C / Second Max.
Time (25°C to Peak Temperature)		8 Minutes Max.

Temperature Derating Curve

Normal ambient temperature: 23+/-3°C

Operating temperature: -55 ~ 125°C, with proper correction factor applied

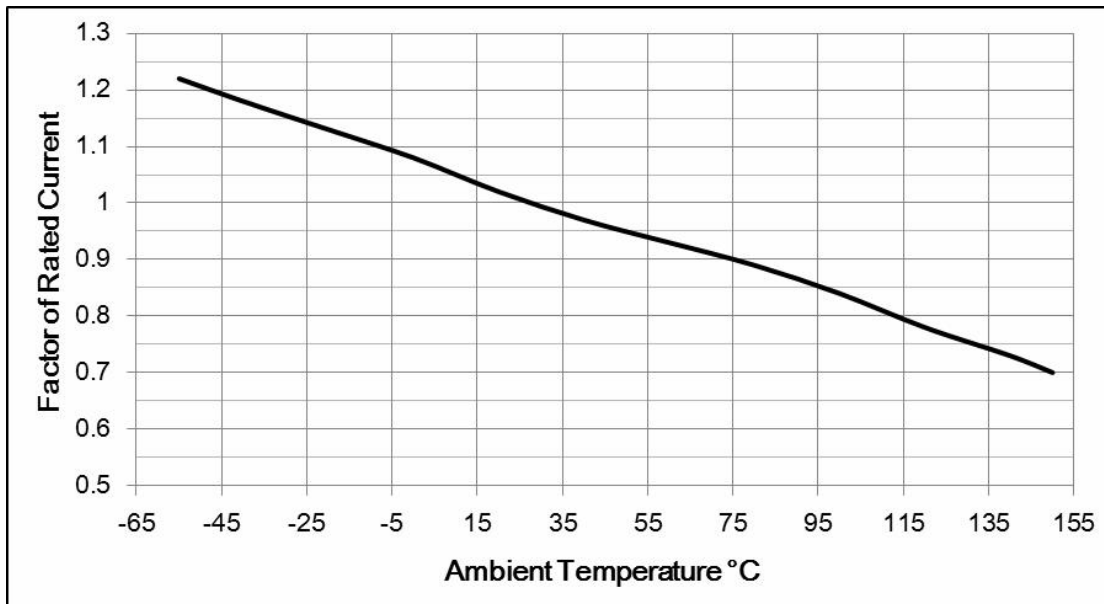

包装尺寸 Packing size

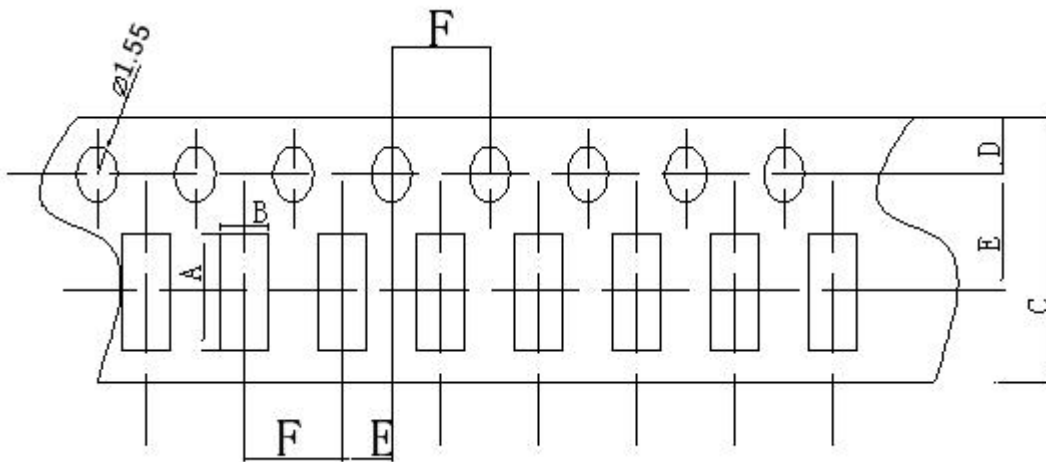

代码 Code	A	B	C	D	E	F
尺寸 size(unit: mm)	3.5	1.9	8	1.75	3.5	4

Package

3000 fuses on 8mm tape-and-reel on a 7 inch (178mm) reel per EIA Standard 481.

--- End of Document ---

X-ON Electronics

Largest Supplier of Electrical and Electronic Components

Click to view similar products for [Surface Mount Fuses](#) category:

Click to view products by [TLC manufacturer](#):

Other Similar products are found below :

[FHC20402ADTP](#) [NFVC6125S0R50TRF](#) [TF16SN2.00TTD](#) [FCC16501ABTP](#) [FCC16102ABTP](#) [FHC16322ADTP](#) [0308001.UR](#)
[FCC16202ABTP](#) [F0603G0R03FNTR](#) [7010.9962.63](#) [SEF 12A 65V \(G\)](#) [MST 250mA 250V](#) [TB60](#) [06 100.4](#) [TBF50](#) [TBF40](#)
[2010T315mA250V](#) [06 110.7](#) [12 100.1.5](#) [06 110.5](#) [1206FA-R250](#) [R06.100.6](#) [R12.100.15](#) [R06.000.0.375](#) [R06.000.6](#) [R06.100.0.25](#) [R12.000.8](#)
[R06.100.0.75](#) [R06.100.0.375](#) [R06.100.0.5](#) [R06.000.7](#) [R06.100.7](#) [S0603-S-2.0A](#) [F06F3.5](#) [F12F20](#) [TA3VT2](#) [F12F1](#) [F06F7](#) [F06T3.5](#)
[F06F0.375](#) [F06T8](#) [F12F30](#) [4T2A250V](#) [R12.100.7](#) [R12.100.30](#) [R06.000.0.25](#) [R12.100.6](#) [R12.000.0.25](#) [R12.000.6](#) [R12.000.10](#)