

Features

- High Blocking Voltage with Low On-Resistance
- High Speed Switching with Low Capacitances
- Easy to Parallel and Simple to Drive
- Avalanche Ruggedness
- Resistant to Latch-Up
- Halogen Free, RoHS Compliant

Benefits

- Higher System Efficiency
- Reduced Cooling Requirements
- Increased Power Density
- Increased System Switching Frequency

Applications

- Solar Inverters
- Switch Mode Power Supplies
- High Voltage DC/DC Converters
- LED Lighting Power Supplies

Package



(1) (2) (3)

TO-247-3

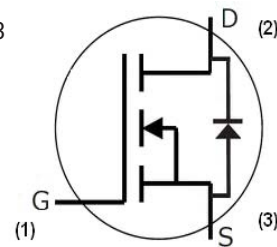

Maximum Ratings ($T_C = 25\text{ }^\circ\text{C}$ unless otherwise specified)

Symbol	Parameter	Value	Unit	Test Conditions	Note
V_{DSmax}	Drain - Source Voltage	1200	V	$V_{GS} = 0\text{ V}, I_D = 100\text{ }\mu\text{A}$	
V_{GSmax}	Gate - Source Voltage	-10/+25	V	Absolute maximum values	
V_{GSop}	Gate - Source Voltage	-5/+20	V	Recommended operational values	
I_D	Continuous Drain Current	19	A	$V_{GS} = 20\text{ V}, T_C = 25\text{ }^\circ\text{C}$	Fig. 19
		12.5		$V_{GS} = 20\text{ V}, T_C = 100\text{ }^\circ\text{C}$	
$I_{D(pulse)}$	Pulsed Drain Current	40	A	Pulse width t_p limited by T_{Jmax}	Fig. 22
P_D	Power Dissipation	125	W	$T_C = 25\text{ }^\circ\text{C}, T_J = 150\text{ }^\circ\text{C}$	Fig. 20
T_J, T_{stg}	Operating Junction and Storage Temperature	-55 to +175	$^\circ\text{C}$		
T_L	Solder Temperature	260	$^\circ\text{C}$	1.6mm (0.063") from case for 10s	
M_d	Mounting Torque	1	Nm lbf-in	M3 or 6-32 screw	
		8.8			

Electrical Characteristics ($T_c = 25^\circ\text{C}$ unless otherwise specified)

Symbol	Parameter	Min.	Typ.	Max.	Unit	Test Conditions	Note
$V_{(BR)DSS}$	Drain-Source Breakdown Voltage	1200			V	$V_{GS} = 0\text{ V}, I_D = 100\ \mu\text{A}$	
$V_{GS(th)}$	Gate Threshold Voltage	2.0	2.5	4	V	$V_{DS} = V_{GS}, I_{DS} = 2.5\ \text{mA}$	Fig. 11
			1.8		V	$V_{DS} = V_{GS}, I_{DS} = 2.5\ \text{mA}, T_J = 150^\circ\text{C}$	
I_{DSS}	Zero Gate Voltage Drain Current		1	100	μA	$V_{DS} = 1200\ \text{V}, V_{GS} = 0\ \text{V}$	
I_{GSS}	Gate-Source Leakage Current			200	nA	$V_{GS} = 20\ \text{V}, V_{DS} = 0\ \text{V}$	
$R_{DS(on)}$	Drain-Source On-State Resistance		165	196	m Ω	$V_{GS} = 20\ \text{V}, I_D = 10\ \text{A}$	Fig. 4, 5, 6
			300			$V_{GS} = 20\ \text{V}, I_D = 10\ \text{A}, T_J = 150^\circ\text{C}$	
g_{fs}	Transconductance		3.5		S	$V_{DS} = 20\ \text{V}, I_{DS} = 10\ \text{A}$	Fig. 7
			3.3			$V_{DS} = 20\ \text{V}, I_{DS} = 10\ \text{A}, T_J = 150^\circ\text{C}$	
C_{iss}	Input Capacitance		950		pF	$V_{GS} = 0\ \text{V}$ $V_{DS} = 1000\ \text{V}$ $f = 1\ \text{MHz}$ $V_{AC} = 25\ \text{mV}$	Fig. 17, 18
C_{oss}	Output Capacitance		8				
C_{rSS}	Reverse Transfer Capacitance		36				
E_{oss}	C_{oss} Stored Energy		25				
E_{AS}	Avalanche Energy, Single Pluse		120		mJ	$I_D = 10\ \text{A}, V_{DD} = 50\ \text{V}$	Fig. 29
E_{ON}	Turn-On Switching Energy		90		μJ	$V_{DS} = 800\ \text{V}, V_{GS} = -5/20\ \text{V}, I_D = 10\ \text{A},$ $R_{G(ext)} = 2.5\ \Omega, L = 256\ \mu\text{H}$	Fig. 25
E_{OFF}	Turn Off Switching Energy		35				
$t_{d(on)}$	Turn-On Delay Time		20		ns	$V_{DD} = 800\ \text{V}, V_{GS} = -5/20\ \text{V}$ $I_D = 10\ \text{A}$ $R_{G(ext)} = 2.5\ \Omega, R_L = 80\ \Omega$ Timing relative to V_{DS} Per IEC60747-8-4 pg 83	Fig. 27
t_r	Rise Time		30				
$t_{d(off)}$	Turn-Off Delay Time		23				
t_f	Fall Time		15				
$R_{G(int)}$	Internal Gate Resistance		5.6		Ω	$f = 1\ \text{MHz}, V_{AC} = 25\ \text{mV}$	
Q_{gs}	Gate to Source Charge		12		nC	$V_{DS} = 800\ \text{V}, V_{GS} = -5/20\ \text{V}$ $I_D = 10\ \text{A}$ Per IEC60747-8-4 pg 21	Fig. 12
Q_{gd}	Gate to Drain Charge		17				
Q_g	Total Gate Charge		50				

Reverse Diode Characteristics

Symbol	Parameter	Typ.	Max.	Unit	Test Conditions	Note
V_{SD}	Diode Forward Voltage	3.5		V	$V_{GS} = -5\ \text{V}, I_F = 5\ \text{A}$	Fig. 8, 9, 10
		3.3			$V_{GS} = -5\ \text{V}, I_F = 5\ \text{A}, T_J = 150^\circ\text{C}$	
I_S	Continuous Diode Forward Current		19	A	$T_c = 25^\circ\text{C}$	Note 1
t_{rr}	Reverse Recovery Time	23		ns	$V_{GS} = -5\ \text{V}, I_{SD} = 10\ \text{A}, V_R = 800\ \text{V}$ $dif/dt = 3200\ \text{A}/\mu\text{s}$	Note 1
Q_{rr}	Reverse Recovery Charge	105		nC		
I_{rrm}	Peak Reverse Recovery Current	9		A		

Note (1): When using SiC Body Diode the maximum recommended $V_{GS} = -5\text{V}$

Thermal Characteristics

Symbol	Parameter	Typ.	Max.	Unit	Test Conditions	Note
$R_{\theta JC}$	Thermal Resistance from Junction to Case	0.9	1.0	K/W		Fig. 21
$R_{\theta JA}$	Thermal Resistance From Junction to Ambient		40			

Typical Performance

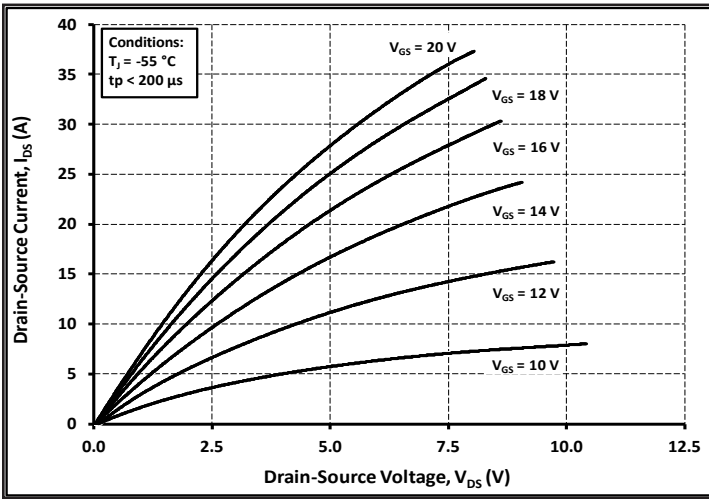

Figure 1. Output Characteristics $T_J = -55\text{ }^\circ\text{C}$

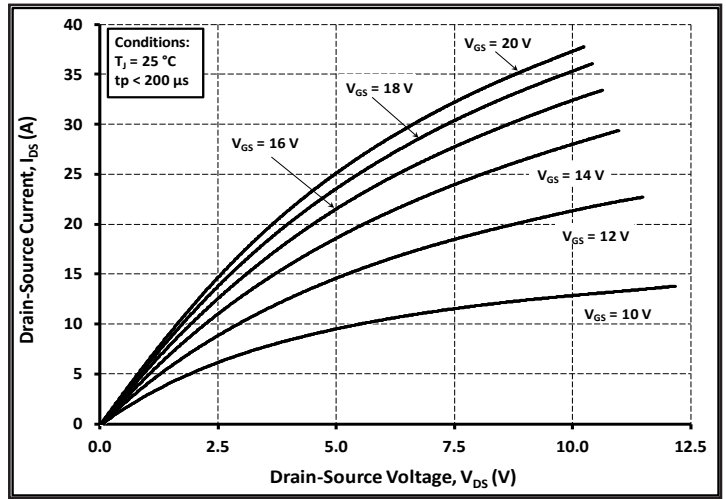

Figure 2. Output Characteristics $T_J = 25\text{ }^\circ\text{C}$

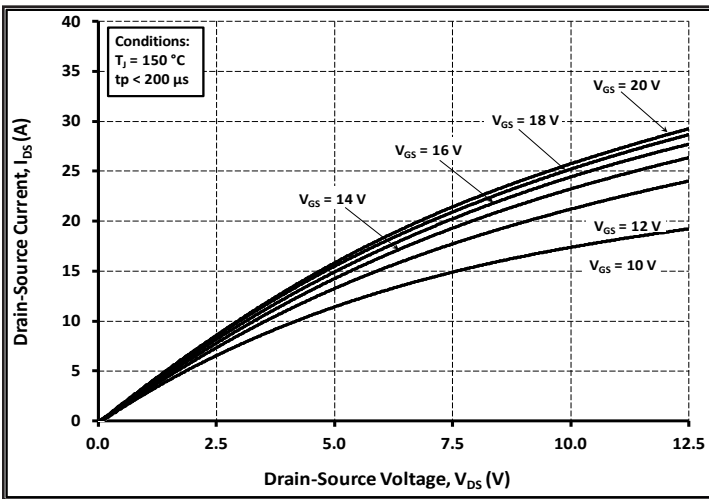

Figure 3. Output Characteristics $T_J = 150\text{ }^\circ\text{C}$

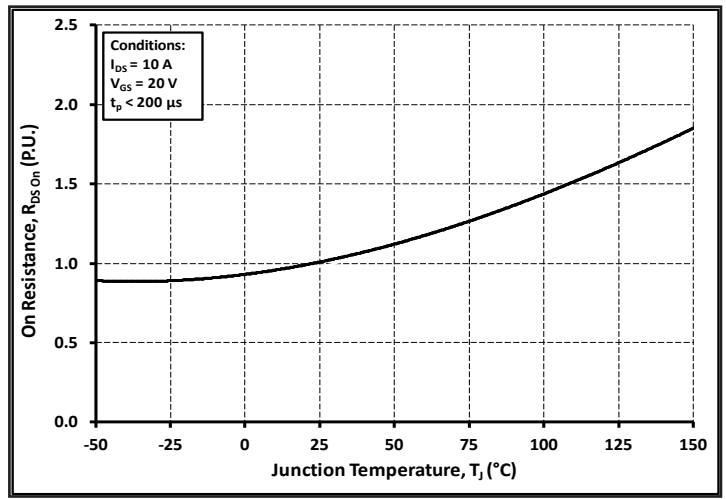

Figure 4. Normalized On-Resistance vs. Temperature

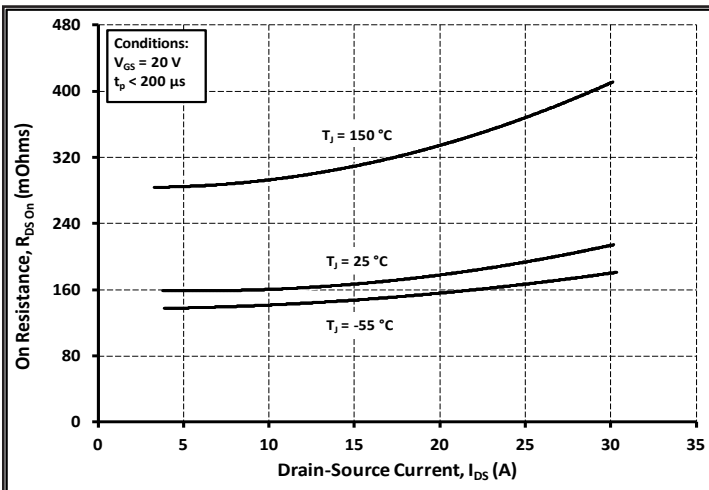

Figure 5. On-Resistance vs. Drain Current For Various Temperatures

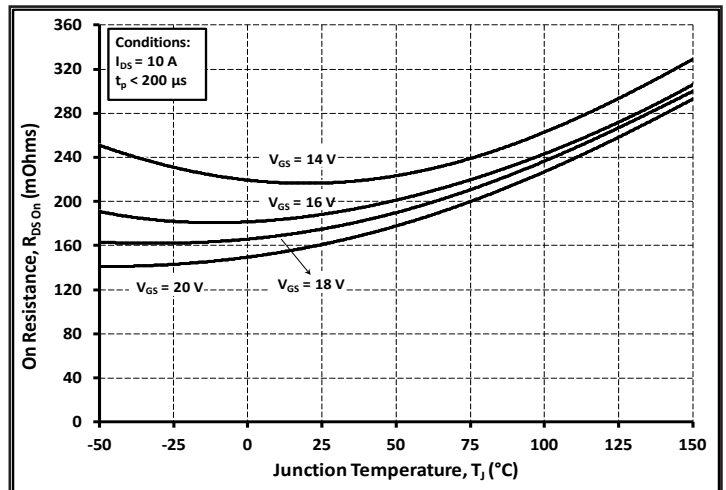

Figure 6. On-Resistance vs. Temperature For Various Gate Voltage

Typical Performance

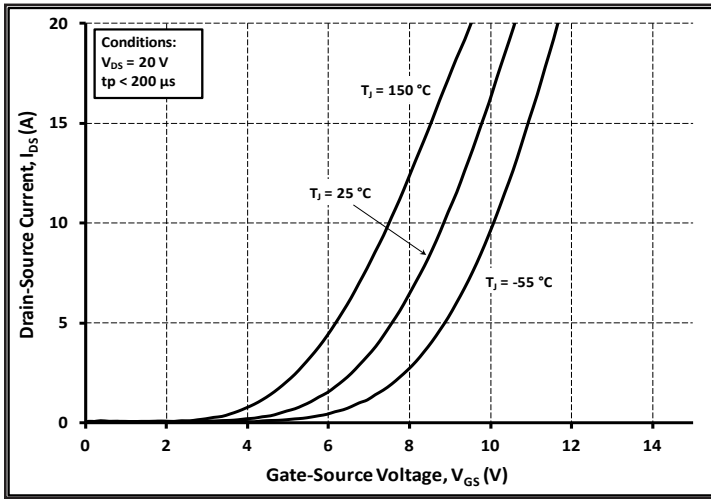

Figure 7. Transfer Characteristic for Various Junction Temperatures

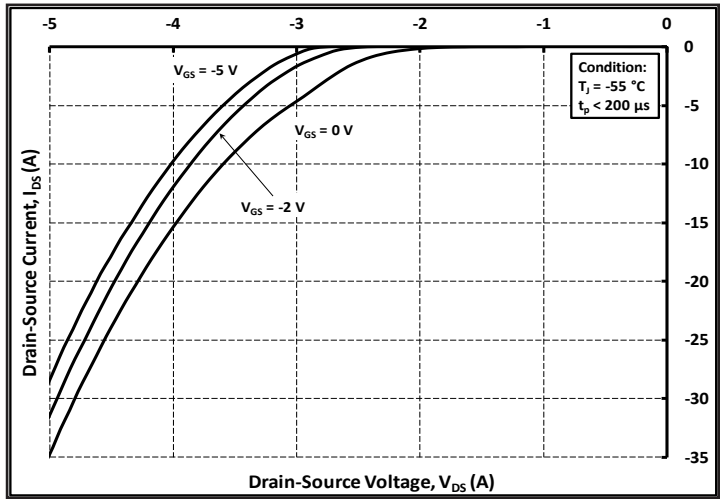

Figure 8. Body Diode Characteristic at -55 °C

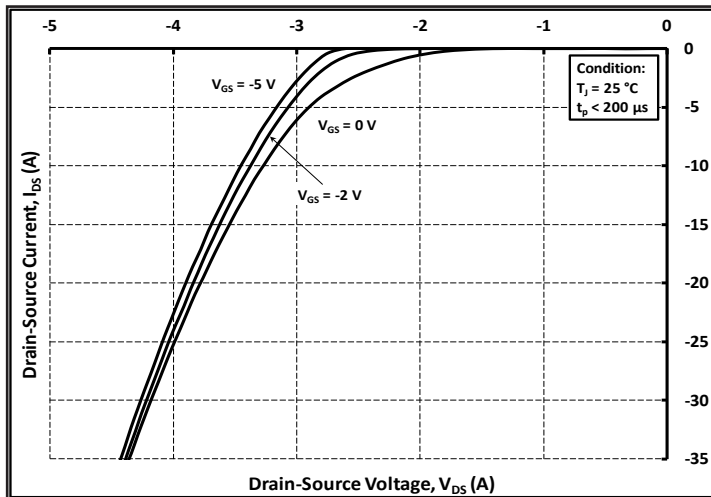

Figure 9. Body Diode Characteristic at 25 °C

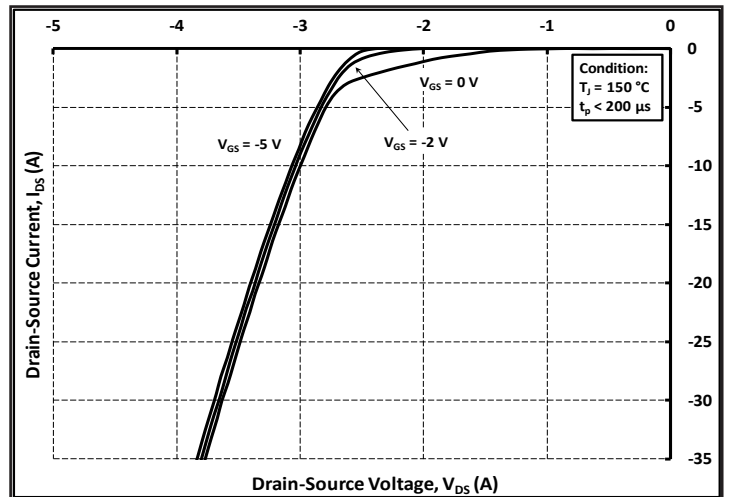

Figure 10. Body Diode Characteristic at 150 °C

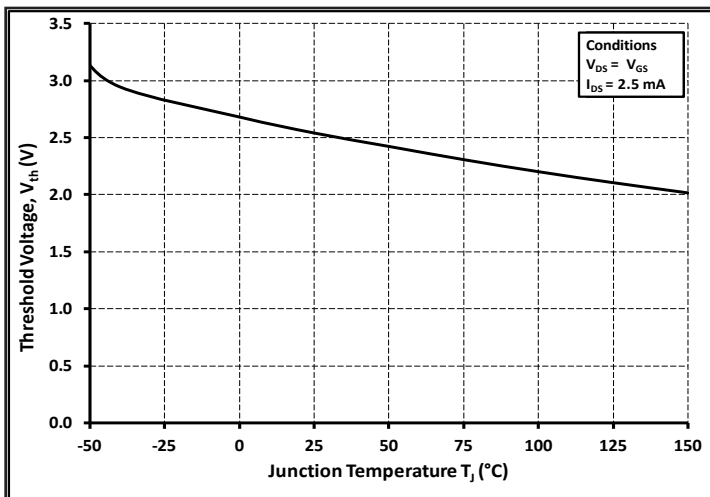

Figure 11. Threshold Voltage vs. Temperature

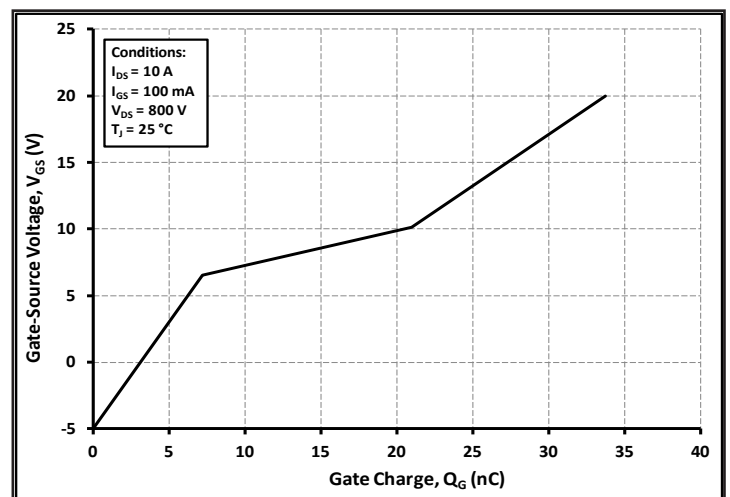

Figure 12. Gate Charge Characteristics

Typical Performance

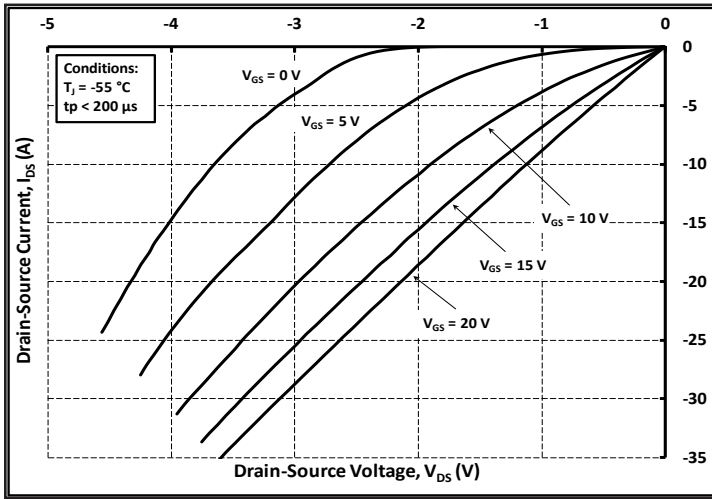

Figure 13. 3rd Quadrant Characteristic at $-55\text{ }^\circ\text{C}$

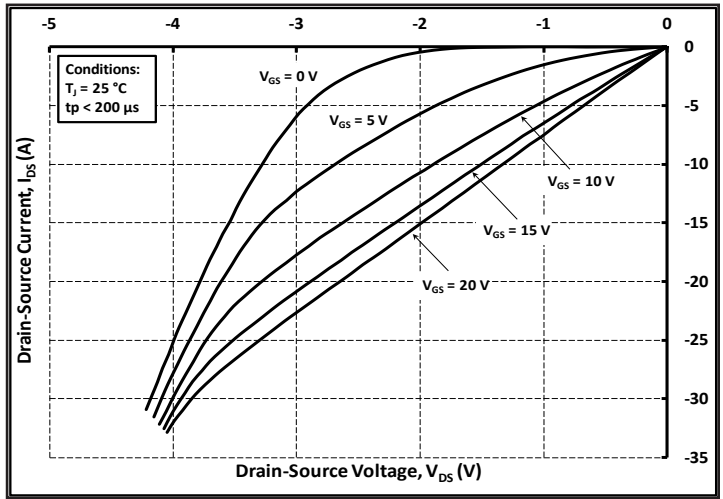

Figure 14. 3rd Quadrant Characteristic at $25\text{ }^\circ\text{C}$

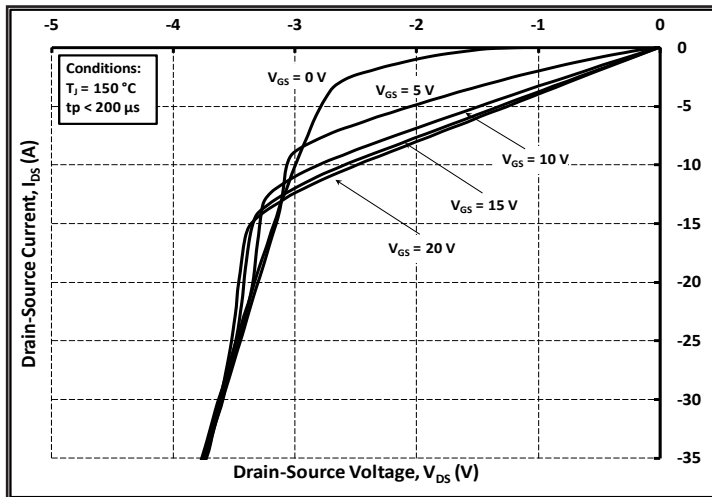

Figure 15. 3rd Quadrant Characteristic at $150\text{ }^\circ\text{C}$

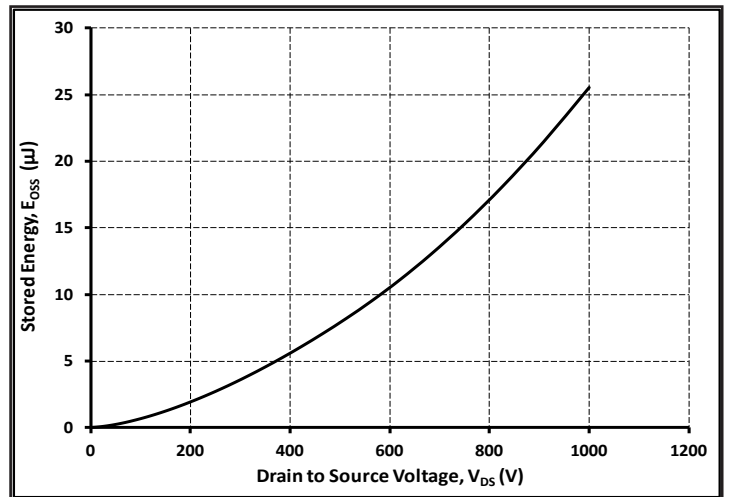

Figure 16. Output Capacitor Stored Energy

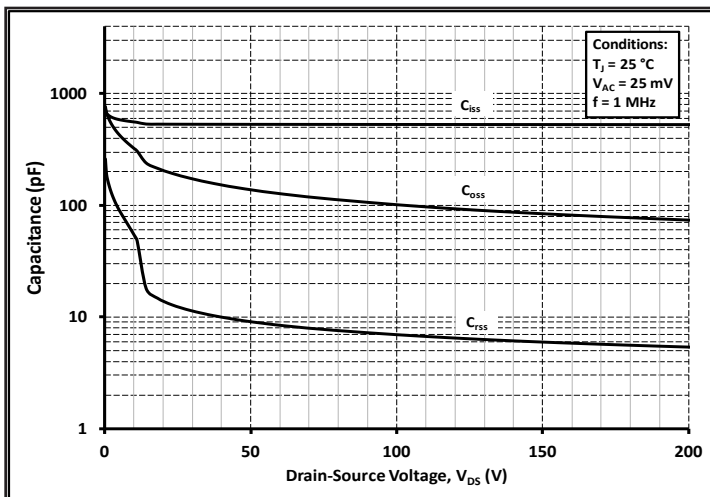

Figure 17. Capacitances vs. Drain-Source Voltage (0 - 200V)

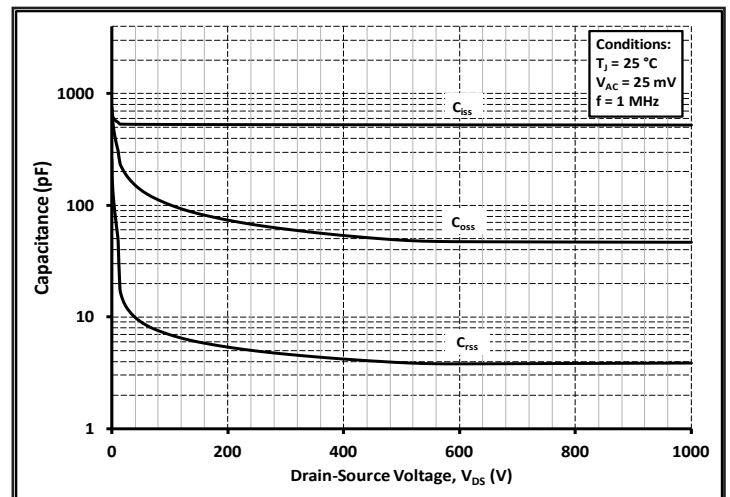

Figure 18. Capacitances vs. Drain-Source Voltage (0 - 1000V)

Typical Performance

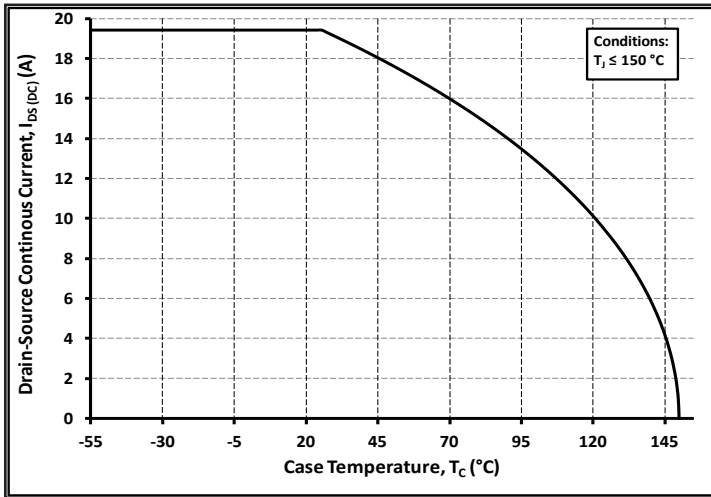

Figure 19. Continuous Drain Current Derating vs. Case Temperature

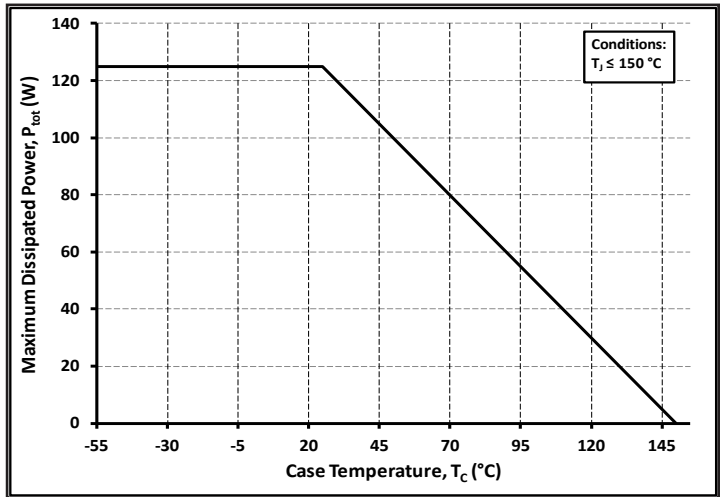

Figure 20. Maximum Power Dissipation Derating vs. Case Temperature

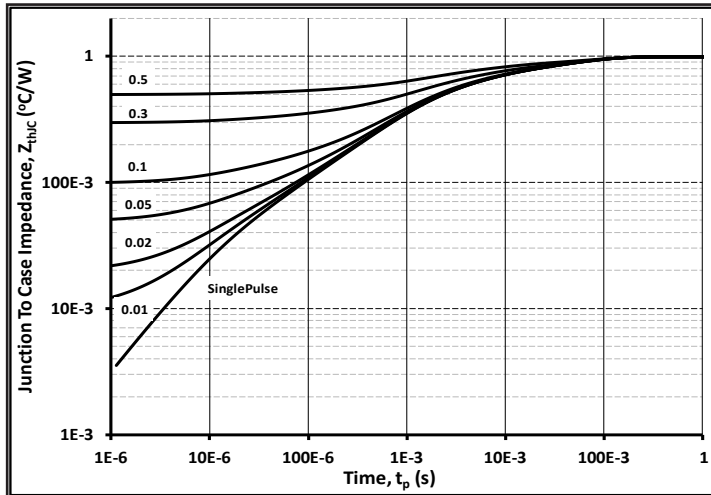

Figure 21. Transient Thermal Impedance (Junction - Case)

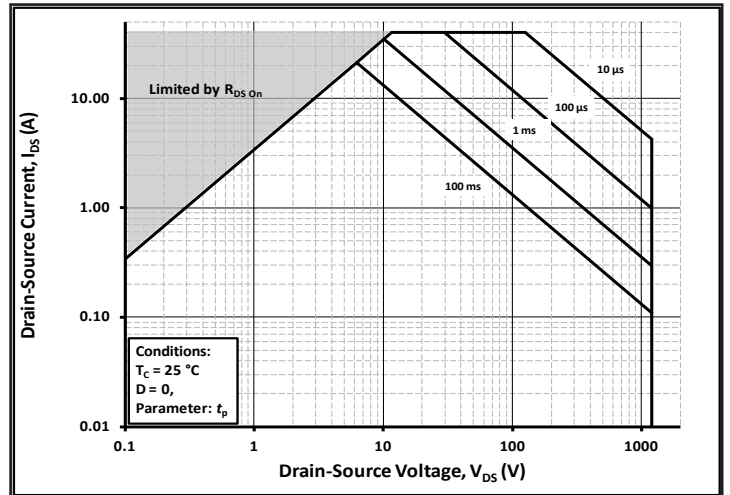

Figure 22. Safe Operating Area

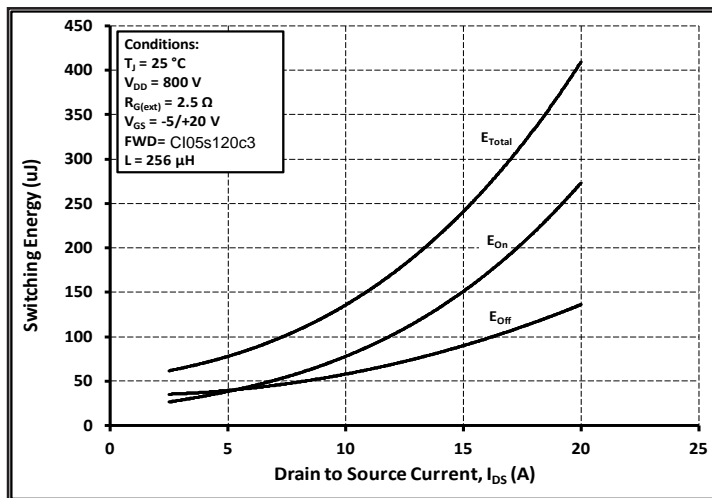

Figure 23. Clamped Inductive Switching Energy vs. Drain Current ($V_{DS} = 800 \text{ V}$)

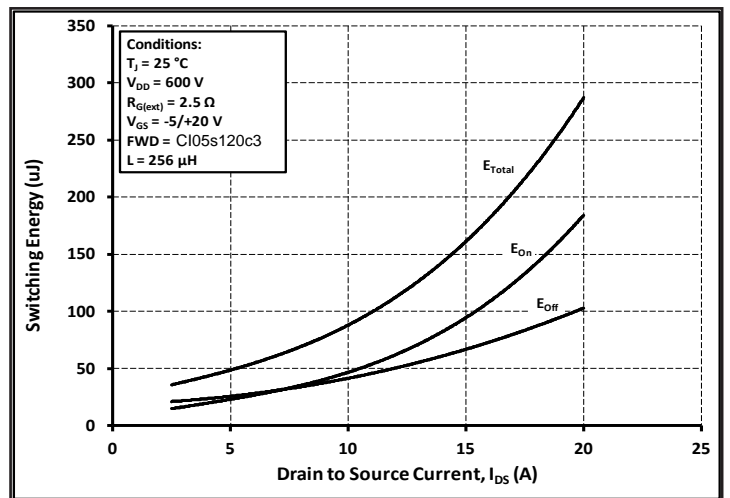

Figure 24. Clamped Inductive Switching Energy vs. Drain Current ($V_{DS} = 600 \text{ V}$)

Typical Performance

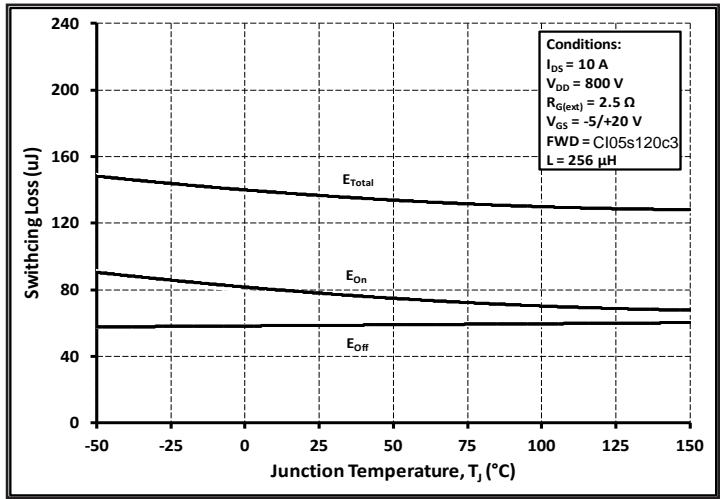
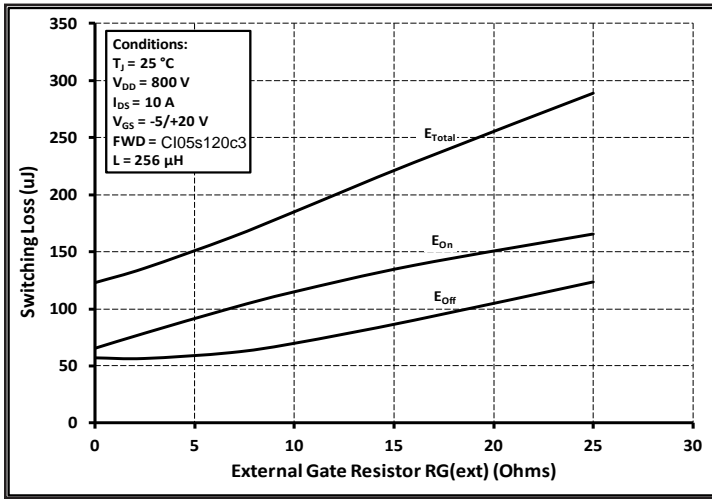

Figure 25. Clamped Inductive Switching Energy vs. $R_{G(ext)}$

Figure 26. Clamped Inductive Switching Energy vs. Temperature

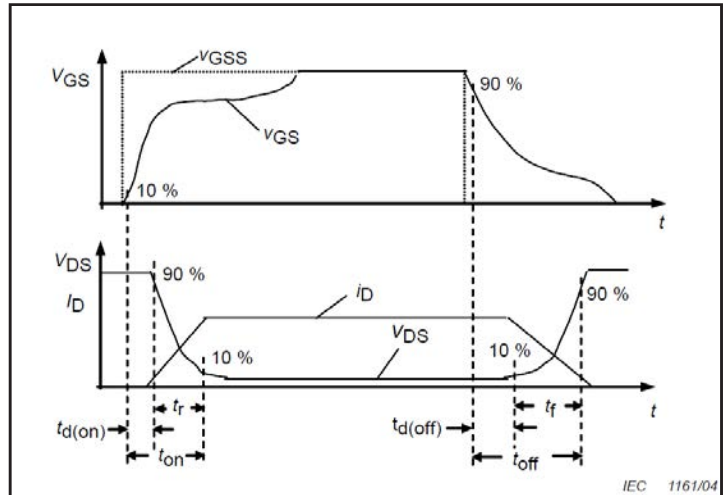
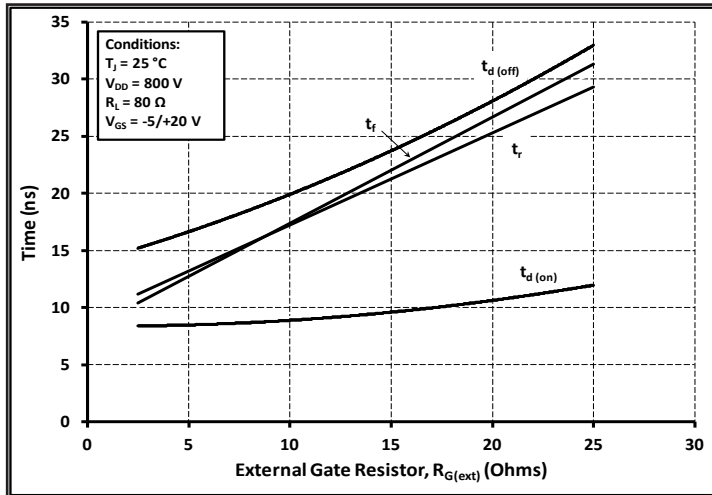

Figure 27. Switching Times vs. $R_{G(ext)}$

Figure 28. Switching Times Definition

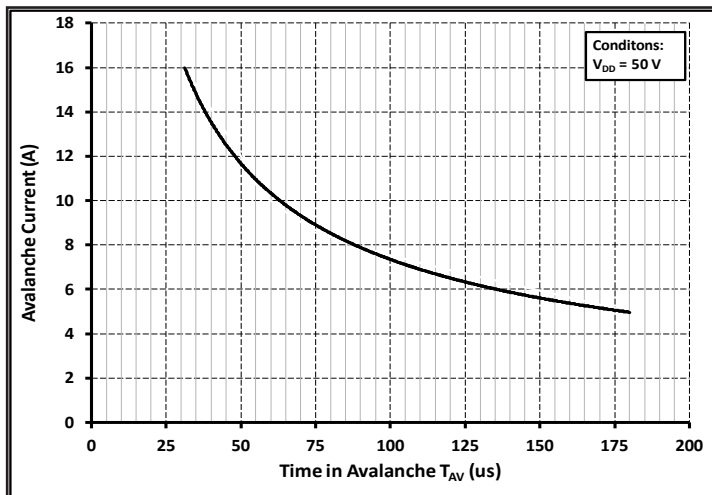

Figure 29. Single Avalanche SOA curve

Test Circuit Schematic

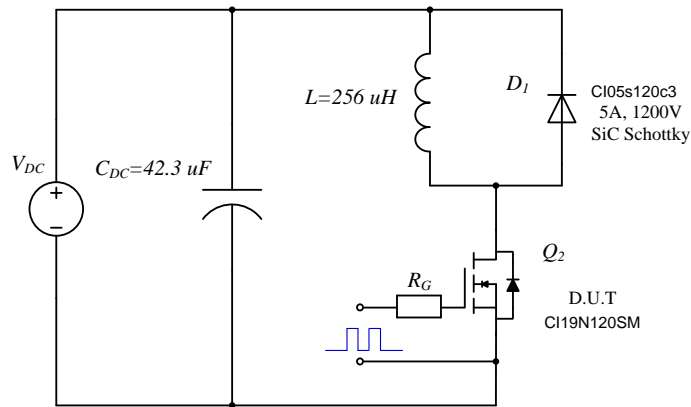

Figure 30. Clamped Inductive Switching Waveform Test Circuit

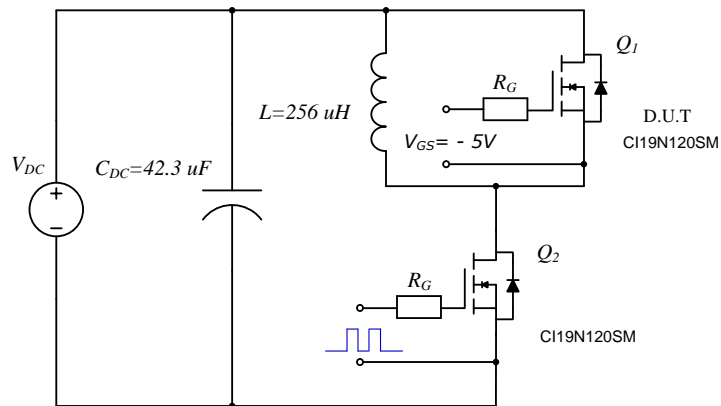
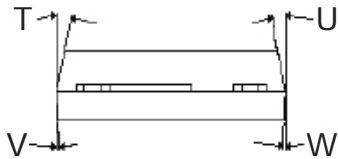
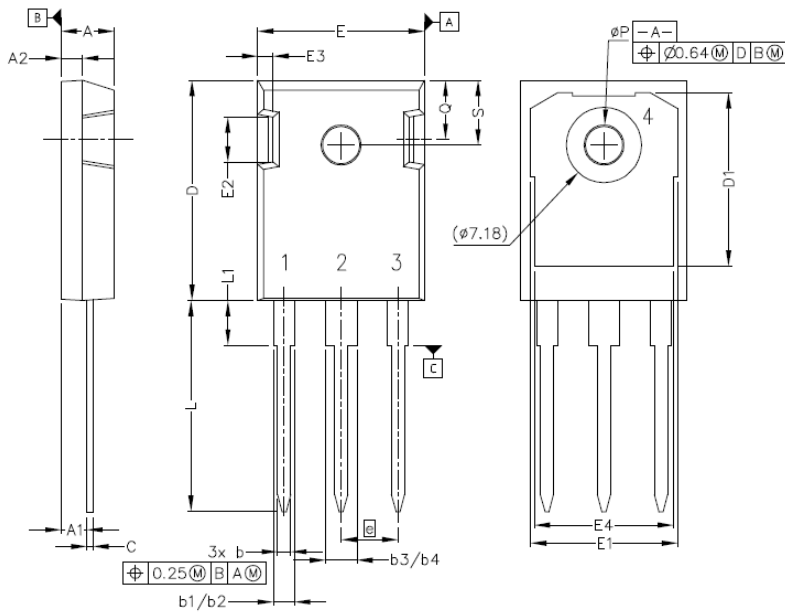

Figure 31. Body Diode Recovery Test Circuit

Package Dimensions

Package TO-247-3



Pinout Information:

- Pin 1 = Gate
- Pin 2, 4 = Drain
- Pin 3 = Source

POS	Inches		Millimeters	
	Min	Max	Min	Max
A	.190	.205	4.83	5.21
A1	.090	.100	2.29	2.54
A2	.075	.085	1.91	2.16
b	.042	.052	1.07	1.33
b1	.075	.095	1.91	2.41
b2	.075	.085	1.91	2.16
b3	.113	.133	2.87	3.38
b4	.113	.123	2.87	3.13
c	.022	.027	0.55	0.68
D	.819	.831	20.80	21.10
D1	.640	.695	16.25	17.65
D2	.037	.049	0.95	1.25
E	.620	.635	15.75	16.13
E1	.516	.557	13.10	14.15
E2	.145	.201	3.68	5.10
E3	.039	.075	1.00	1.90
E4	.487	.529	12.38	13.43
e	.214 BSC		5.44 BSC	
N	3		3	
L	.780	.800	19.81	20.32
L1	.161	.173	4.10	4.40
ØP	.138	.144	3.51	3.65
Q	.216	.236	5.49	6.00
S	.238	.248	6.04	6.30
T	9°	11°	9°	11°
U	9°	11°	9°	11°
V	2°	8°	2°	8°
W	2°	8°	2°	8°

Recommended Solder Pad Layout

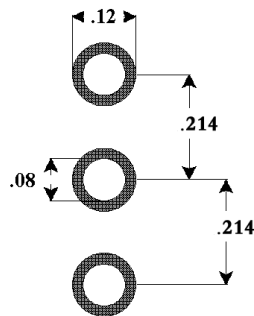

TO-247-3

X-ON Electronics

Largest Supplier of Electrical and Electronic Components

Click to view similar products for [MOSFET](#) category:

Click to view products by [Tokmas](#) manufacturer:

Other Similar products are found below :

[IRFD120](#) [JANTX2N5237](#) [2SK2267\(Q\)](#) [BUK455-60A/B](#) [TK100A10N1,S4X\(S](#) [MIC4420CM-TR](#) [VN1206L](#) [NDP4060](#) [SI4482DY](#)
[IRS2092STRPBF-EL](#) [IPS70R2K0CEAKMA1](#) [TK31J60W5,S1VQ\(O](#) [TK31J60W,S1VQ\(O](#) [TK16J60W,S1VQ\(O](#) [2SK2614\(TE16L1,Q\)](#)
[DMN1017UCP3-7](#) [EFC2J004NUZTDG](#) [P85W28HP2F-7071](#) [DMN1053UCP4-7](#) [NTE2384](#) [DMC2700UDMQ-7](#) [DMN2080UCB4-7](#)
[DMN61D9UWQ-13](#) [US6M2GTR](#) [DMN31D5UDJ-7](#) [DMP22D4UFO-7B](#) [IPS60R3K4CEAKMA1](#) [DMN1006UCA6-7](#) [DMN16M9UCA6-7](#)
[STF5N65M6](#) [IRF40H233XTMA1](#) [STU5N65M6](#) [DMN6022SSD-13](#) [DMN13M9UCA6-7](#) [DMTH10H4M6SPS-13](#) [IPS60R360PFD7SAKMA1](#)
[DMN2990UFB-7B](#) [SSM3K35CT,L3F](#) [IPLK60R1K0PFD7ATMA1](#) [2N7002W-G](#) [MCAC30N06Y-TP](#) [IPWS65R035CFD7AXKSA1](#)
[MCQ7328-TP](#) [SSM3J143TU,LXHF](#) [DMN12M3UCA6-7](#) [PJMF280N65E1_T0_00201](#) [PJMF380N65E1_T0_00201](#)
[PJMF280N60E1_T0_00201](#) [PJMF600N65E1_T0_00201](#) [PJMF900N65E1_T0_00201](#)