

Features

- 1.2kV Schottky Rectifier
- Zero Reverse Recovery Current
- High-Frequency Operation
- Temperature-Independent Switching
- Extremely Fast Switching

Benefits

- Replace Bipolar with Unipolar Rectifiers
- Essentially No Switching Losses
- Higher Efficiency
- Reduction of Heat Sink Requirements
- Parallel Devices Without Thermal Runaway

Applications

- Switch Mode Power Supplies (SMPS)
- Boost diodes in PFC or DC/DC stages
- Free Wheeling Diodes in Inverter stages
- AC/DC converters

Package

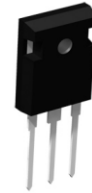

TO-247-3

(1) (2) (3)

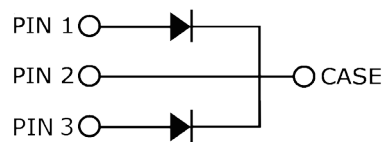

Maximum Ratings (T_C=25°C unless otherwise specified)

Symbol	Parameter	Value	Unit	Test Conditions	Note
V _{RRM}	Repetitive Peak Reverse Voltage	1200	V		
V _{RSM}	Surge Peak Reverse Voltage	1300	V		
V _R	DC Peak Reverse Voltage	1200	V		
I _F	Continuous Forward Current (Per Leg/Device)	56.5/113 27/54 20/40	A	T _C =25°C T _C =135°C T _C =150°C	Fig. 3
I _{FRM}	Repetitive Peak Forward Surge Current	91* 61*	A	T _C =25°C, t _p =10 ms, Half Sine Pulse T _C =110°C, t _p =10 ms, Half Sine Pulse	
I _{FSM}	Non-Repetitive Forward Surge Current	130* 110*	A	T _C =25°C, t _p =10 ms, Half Sine Pulse T _C =110°C, t _p =10 ms, Half Sine Pulse	Fig. 8
I _{F,Max}	Non-Repetitive Peak Forward Current	1150* 950*	A	T _C =25°C, t _p =10 μs, Pulse T _C =110°C, t _p =10 μs, Pulse	Fig. 8
P _{tot}	Power Dissipation (Per Leg/Device)	266/532 114/228	W	T _C =25°C T _C =110°C	Fig. 4
dV/dt	Diode dV/dt ruggedness	200	V/ns	V _R =0-960V	
∫i ² dt	i ² t value	84.5* 60.5*	A ² s	T _C =25°C, t _p =10 ms T _C =110°C, t _p =10 ms	
T _J	Operating Junction Range	-55 to +175	°C		
T _{stg}	Storage Temperature Range	-55 to +135	°C		
	TO-247 Mounting Torque	1 8.8	Nm lbf-in	M3 Screw 6-32 Screw	

* Per Leg, ** Per Device

Electrical Characteristics (Per Leg)

Symbol	Parameter	Typ.	Max.	Unit	Test Conditions	Note
V_F	Forward Voltage	1.5 2.0	1.6 2.8	V	$I_F = 20\text{ A } T_J = 25^\circ\text{C}$ $I_F = 20\text{ A } T_J = 175^\circ\text{C}$	Fig. 1
I_R	Reverse Current	35 65	160 350	μA	$V_R = 1200\text{ V } T_J = 25^\circ\text{C}$ $V_R = 1200\text{ V } T_J = 175^\circ\text{C}$	Fig. 2
Q_C	Total Capacitive Charge	99		nC	$V_R = 800\text{ V}, I_F = 20\text{ A}$ $dI/dt = 200\text{ A}/\mu\text{s}$ $T_J = 25^\circ\text{C}$	Fig. 5
C	Total Capacitance	1500 93 67		pF	$V_R = 0\text{ V}, T_J = 25^\circ\text{C}, f = 1\text{ MHz}$ $V_R = 400\text{ V}, T_J = 25^\circ\text{C}, f = 1\text{ MHz}$ $V_R = 800\text{ V}, T_J = 25^\circ\text{C}, f = 1\text{ MHz}$	Fig. 6
E_C	Capacitance Stored Energy	28		μJ	$V_R = 800\text{ V}$	Fig. 7

Note: This is a majority carrier diode, so there is no reverse recovery charge.

Thermal Characteristics

Symbol	Parameter	Typ.	Unit	Note
$R_{\theta JC}$	Thermal Resistance from Junction to Case	0.29** 0.57*	$^\circ\text{C}/\text{W}$	Fig. 9

* Per Leg, ** Per Device

Typical Performance (Per Leg)

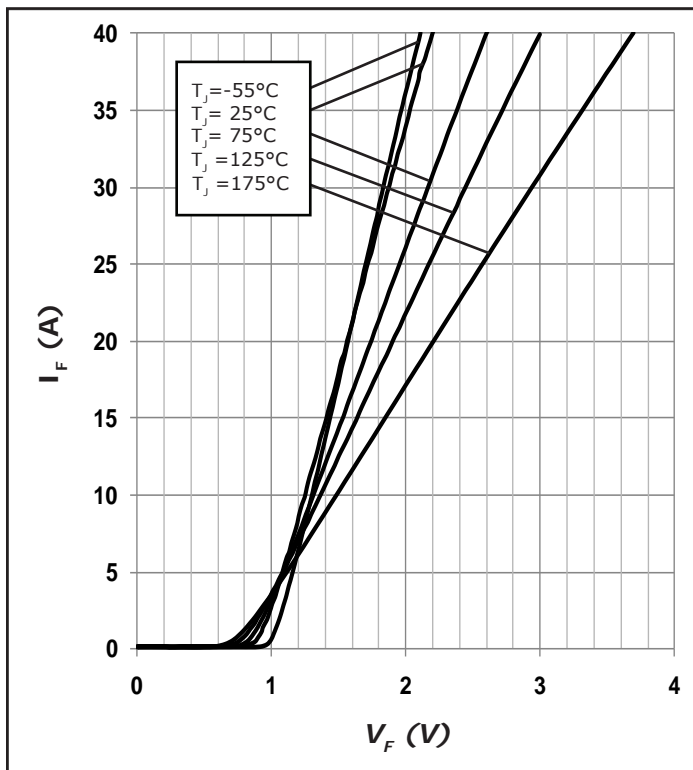

Figure 1. Forward Characteristics

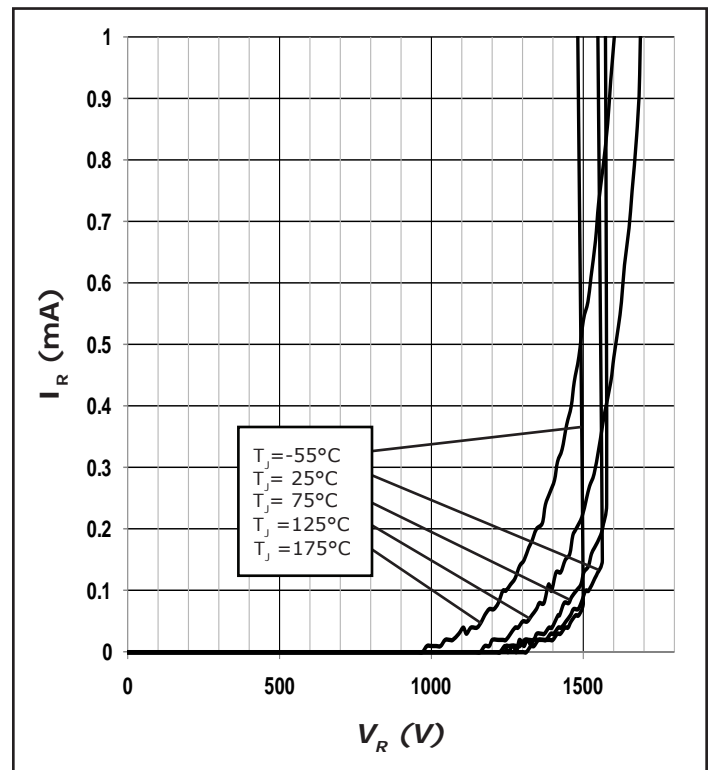

Figure 2. Reverse Characteristics

Typical Performance (Per Leg)

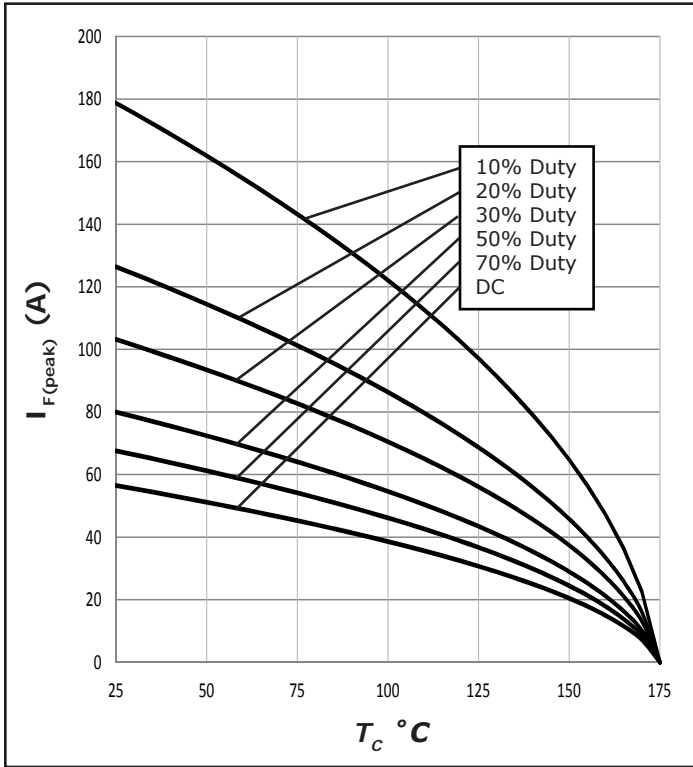

Figure 3. Current Derating

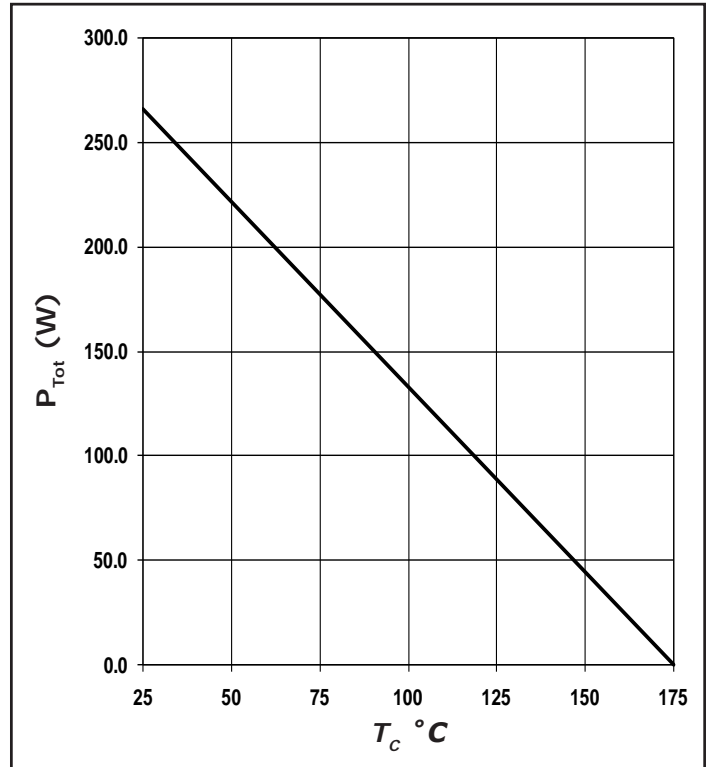

Figure 4. Power Derating

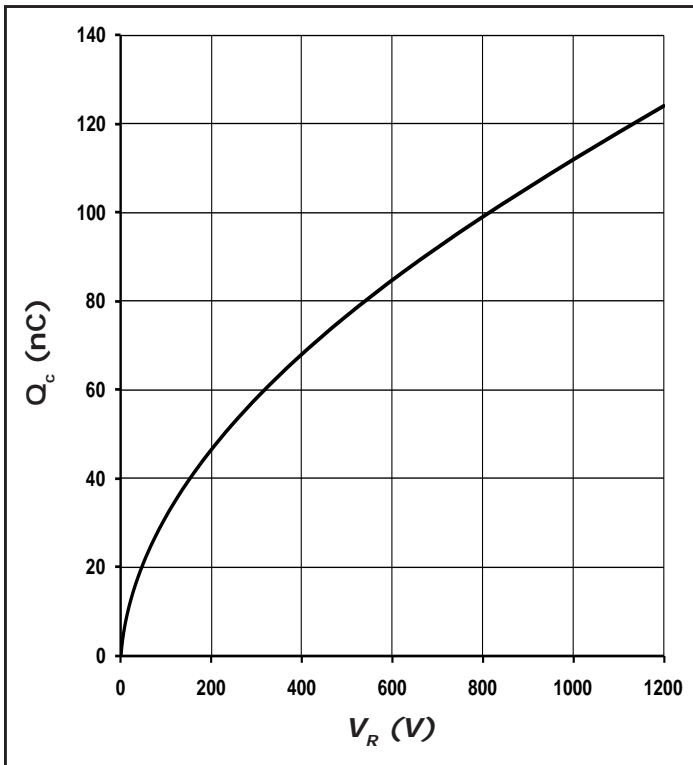

Figure 5. Recovery Charge vs. Reverse Voltage

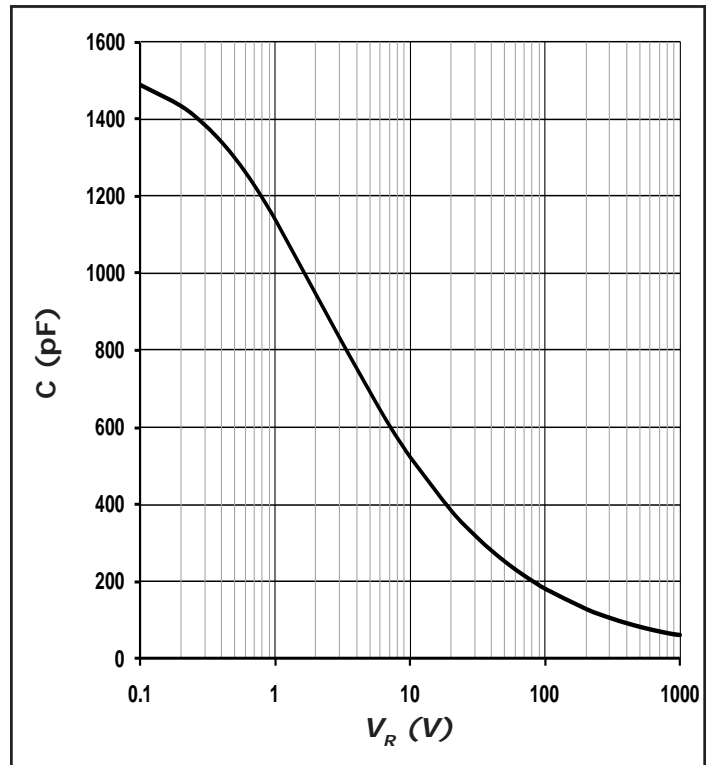

Figure 6. Capacitance vs. Reverse Voltage

Typical Performance

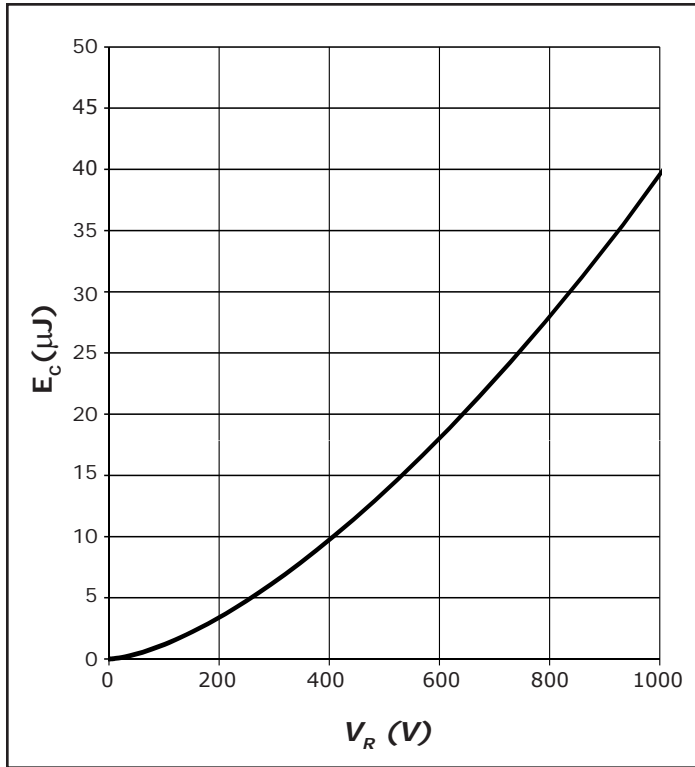

Figure 7. Typical Capacitance Stored Energy, per leg

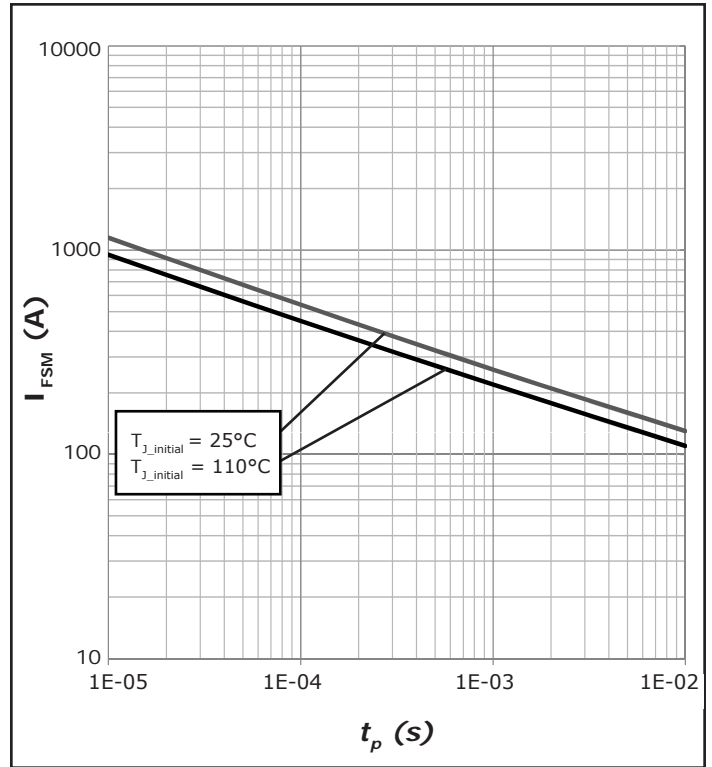

Figure 8. Non-Repetitive Peak Forward Surge Current versus Pulse Duration (sinusoidal waveform), per leg

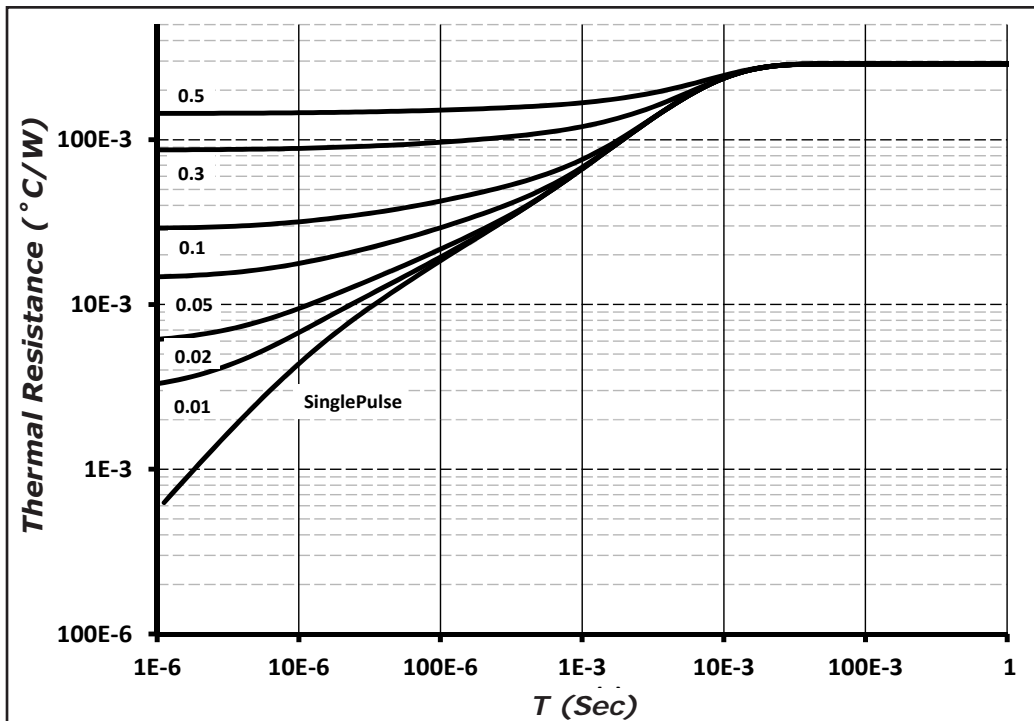
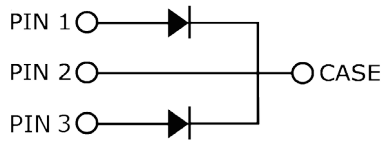
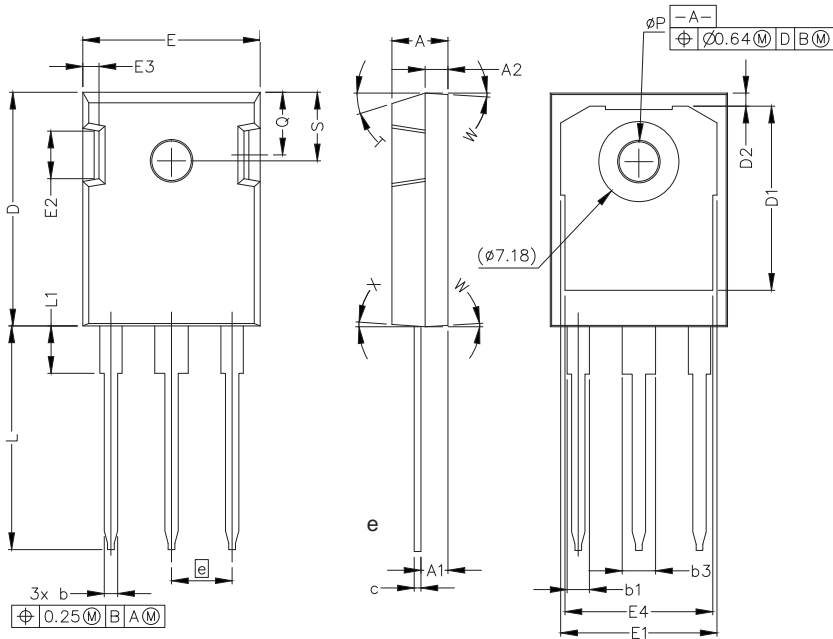

Figure 9. Device Transient Thermal Impedance

Package Dimensions

Package TO-247-3



POS	Inches		Millimeters	
	Min	Max	Min	Max
A	.190	.205	4.83	5.21
A1	.090	.100	2.29	2.54
A2	.075	.085	1.91	2.16
b	.042	.052	1.07	1.33
b1	.075	.095	1.91	2.41
b3	.113	.133	2.87	3.38
c	.022	.027	0.55	0.68
D	.819	.831	20.80	21.10
D1	.640	.695	16.25	17.65
D2	.037	.049	0.95	1.25
E	.620	.635	15.75	16.13
E1	.516	.557	13.10	14.15
E2	.145	.201	3.68	5.10
E3	.039	.075	1.00	1.90
E4	.487	.529	12.38	13.43
e	.214 BSC		5.44 BSC	
L	.780	.800	19.81	20.32
L1	.161	.173	4.10	4.40
N	3			
ØP	.138	.144	3.51	3.65
Q	.216	.236	5.49	6.00
S	.238	.248	6.04	6.30
T	17.5° REF			
W	3.5° REF			
X	4° REF			

X-ON Electronics

Largest Supplier of Electrical and Electronic Components

Click to view similar products for [Schottky Diodes & Rectifiers](#) category:

Click to view products by [Tokmas](#) manufacturer:

Other Similar products are found below :

[MA4E2039](#) [MA4E2508M-1112](#) [MBR10100CT-BP](#) [MBR1545CT](#) [MMBD301M3T5G](#) [GS1JE-TP](#) [RB160M-50TR](#) [BAS 3010S-02LRH E6327](#)
[BAT 54-02LRH E6327](#) [NSR05F40QNXT5G](#) [NSVR05F40NXT5G](#) [NTE555](#) [JANS1N6640](#) [SB07-03C-TB-H](#) [SBS818-TL-E](#) [SK310-T](#)
[SK33A-TP](#) [SK34B-TP](#) [SS3003CH-TL-E](#) [PDS3100Q-7](#) [GA01SHT18](#) [CRS10I30A\(TE85L,QM](#) [MA4E2501L-1290](#) [MBRB30H30CT-1G](#)
[DMJ3940-000](#) [SB007-03C-TB-E](#) [SK32A-TP](#) [SK33B-TP](#) [SK35A-TP](#) [SK38B-LTP](#) [SK38B-TP](#) [NRVBM120LT1G](#) [NTE505](#)
[NTSB30U100CT-1G](#) [SS0503SH-TL-E](#) [VS-6CWQ10FNHM3](#) [CRG04\(T5L,TEMQ\)](#) [ACDBA1100LR-HF](#) [ACDBA1200-HF](#) [ACDBA2100-HF](#)
[ACDBA240-HF](#) [ACDBA3100-HF](#) [CDBQC0530L-HF](#) [ACDBA260LR-HF](#) [ACDBA1100-HF](#) [MA4E2502L-1246](#) [10BQ060-M3/5BT](#)
[NRVB130LSFT1G](#) [CRS08TE85LQM](#) [PMAD1108-LF](#)