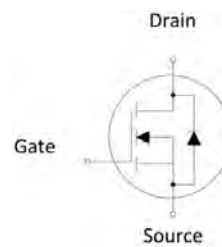

Features

- Ultra-fast body diode
- Very low FOM $R_{DS(on)} \times Q_g$
- Easy to use/drive
- 100% avalanche tested
- RoHS compliant

Applications

- Switch Mode Power Supply (SMPS)
- Uninterruptible Power Supply (UPS)
- Power Factor Correction (PFC)
- LLC Half-bridge
- Charger

Device Marking and Package Information

Device	Package	Marking
CI47N65M3	TO-263	CI47N65M3
CI47N65C3	TO-220	CI47N65C3
CI47N65D4	TO-247	CI47N65D4

Key Performance Parameters

Parameter	Value	Unit
$V_{DS} @ T_{j,max}$	700	V
$R_{DS(on),max}$	0.075	Ω
$Q_{g,typ}$	81	nC
I_D	45	A
$I_{D,pulse}$	135	A
$E_{OSS} @ 400V$	10.29	μJ
t_{rr}	176	ns
Q_{rr}	1.4	μC
I_{rrm}	16	A

Absolute Maximum Ratings $T_C = 25^\circ\text{C}$, unless otherwise noted				
Parameter		Symbol	Values	Unit
Continuous Drain Current	$T_C = 25^\circ\text{C}$	I_D	45	A
	$T_C = 100^\circ\text{C}$		27	
Pulsed Drain Current	(note1)	$I_{D,pulse}$	135	A
Gate-Source Voltage		V_{GSS}	$\pm 30\text{V}$	V
Single Pulse Avalanche Energy	(note2)	E_{AS}	180	mJ
Repetitive Avalanche Energy	(note2)	E_{AR}	144	mJ
Avalanche Current		I_{AR}	6	A
MOSFET dv/dt Ruggedness, $V_{DS} = 0 \dots 650\text{V}$		dv/dt	50	V/ns
Power Dissipation For TO-263,TO-220,TO-247		P_D	312	W
Continuous Diode Forward Current		I_S	45	A
Diode Pulsed Current	(note1)	$I_{S,pulse}$	135	
Reverse Diode dv/dt	(note3)	dv/dt	50	V/ns
Operating Junction and Storage Temperature Range		T_J, T_{stg}	$-55 \sim +150$	$^\circ\text{C}$

Thermal Resistance For TO-263,TO-220,TO-247				
Parameter	Symbol	Value	Unit	
Thermal Resistance, Junction-to-Case	R_{thJC}	0.4	$^\circ\text{C/W}$	
Thermal Resistance, Junction-to-Ambient	R_{thJA}	62		

Electrical Characteristics $T_J = 25^\circ\text{C}$, unless otherwise noted						
Parameter	Symbol	Test Conditions	Value			Unit
			Min.	Typ.	Max.	
Static Characteristics						
Drain-Source Breakdown Voltage	$V_{(BR)DSS}$	$V_{GS} = 0V, I_D = 250\mu\text{A}$	650	--	--	V
Zero Gate Voltage Drain Current	I_{DSS}	$V_{DS} = 650V, V_{GS} = 0V, T_J = 25^\circ\text{C}$	--	--	10	μA
		$V_{DS} = 650V, V_{GS} = 0V, T_J = 150^\circ\text{C}$	--	--	5000	
Gate-Source Leakage Current	I_{GSS}	$V_{GS} = \pm 30V$	--	--	± 100	nA
Gate-Source Threshold Voltage	$V_{GS(th)}$	$V_{DS} = V_{GS}, I_D = 250\mu\text{A}$	2.5	--	4.5	V
Drain-Source On-State-Resistance	$R_{DS(on)}$	$V_{GS} = 10V, I_D = 22A$	--	0.058	0.075	Ω
Gate Resistance	R_G	$f = 1.0\text{MHz}$ open drain	--	1	--	Ω
Dynamic Characteristics						
Input Capacitance	C_{iss}	$V_{GS} = 0V,$ $V_{DS} = 100V,$ $f = 1.0\text{MHz}$	--	4640	--	pF
Output Capacitance	C_{oss}		--	123	--	
Reverse Transfer Capacitance	C_{rss}		--	3.55	--	
Total Gate Charge	Q_g	$V_{DD} = 400V, I_D = 22A,$ $V_{GS} = 10V$	--	81	--	nC
Gate-Source Charge	Q_{gs}		--	25	--	
Gate-Drain Charge	Q_{gd}		--	24	--	
Turn-on Delay Time	$t_{d(on)}$	$V_{DD} = 400V, I_D = 22A,$ $R_G = 25\Omega$	--	107	--	ns
Turn-on Rise Time	t_r		--	80	--	
Turn-off Delay Time	$t_{d(off)}$		--	164	--	
Turn-off Fall Time	t_f		--	52	--	
Drain-Source Body Diode Characteristics						
Body Diode Forward Voltage	V_{SD}	$T_J = 25^\circ\text{C}, I_{SD} = 22A, V_{GS} = 0V$	--	0.9	1.2	V
Reverse Recovery Time	t_{rr}	$V_R = 400V, I_S = 22A,$ $di_F/dt = 100A/\mu\text{s}$	--	176	--	ns
Reverse Recovery Charge	Q_{rr}		--	1.4	--	μC
Peak Reverse Recovery Current	I_{rrm}		--	16	--	A

Notes

1. Repetitive Rating: Pulse width limited by maximum junction temperature
2. $I_D = 10A, V_{DD} = 50V, R_G = 25\Omega$, Starting $T_J = 25^\circ\text{C}$
3. Identical low side and high side switch with identical R_G

Typical Characteristics $T_J = 25^\circ\text{C}$, unless otherwise noted

Figure 1. Output Characteristics

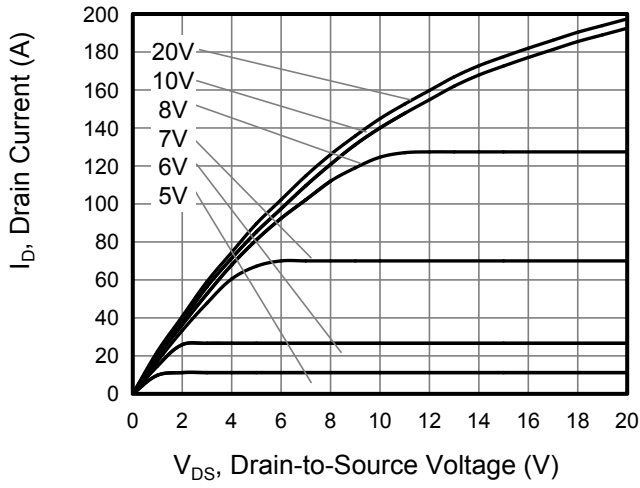

Figure 2. Transfer Characteristics

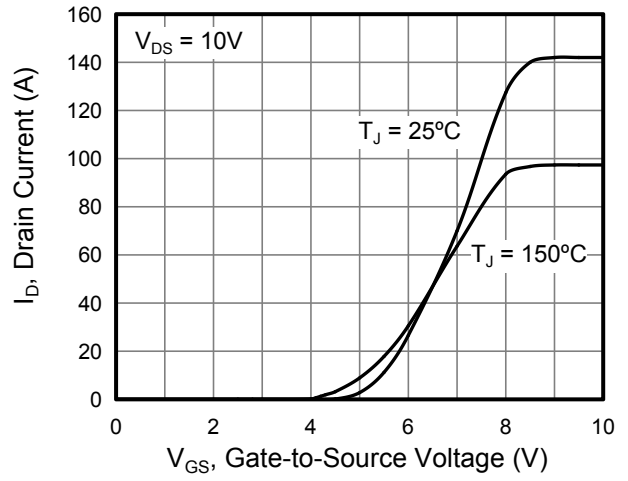

Figure 3. On-Resistance vs. Drain Current

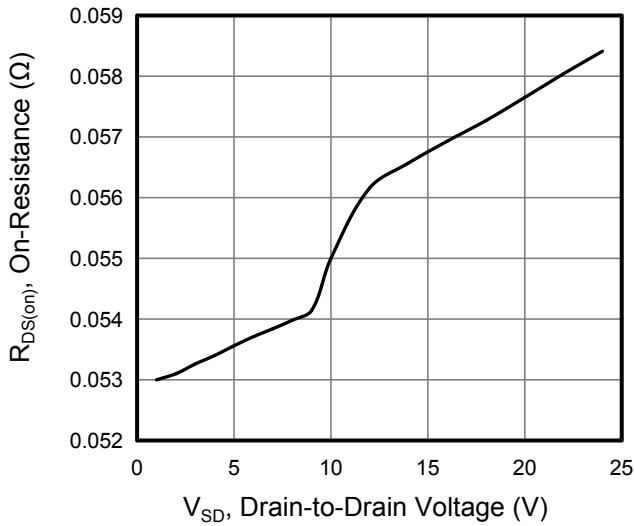

Figure 4. Capacitance

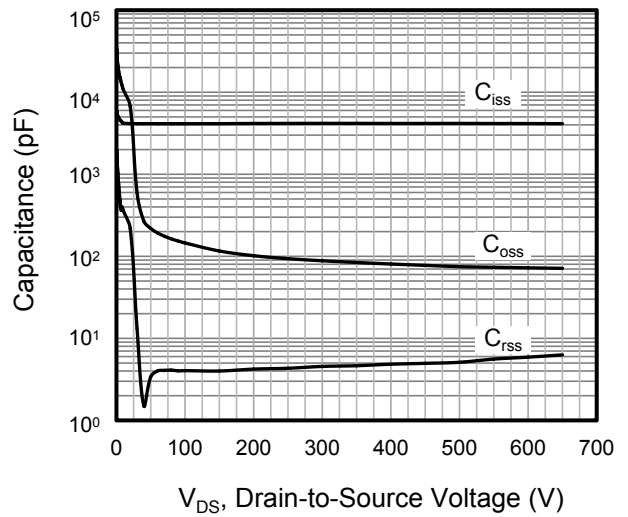

Figure 5. Gate Charge

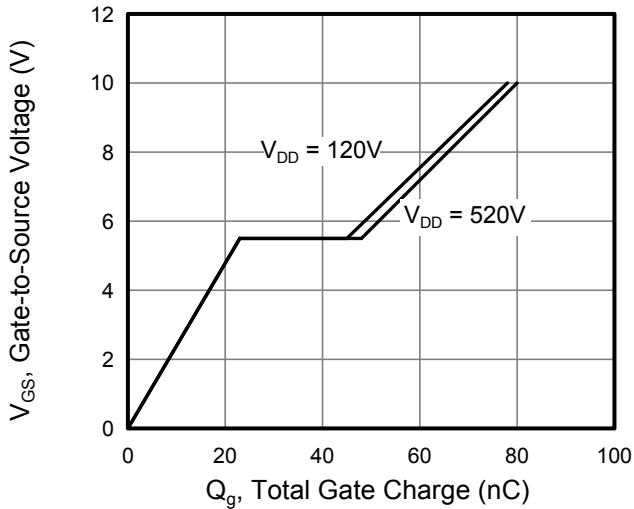

Figure 6. Body Diode Forward Voltage

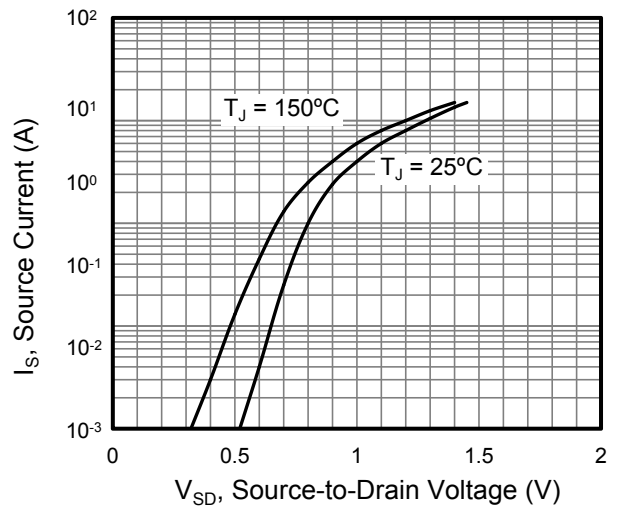

Figure 7. On-Resistance vs. Temperature

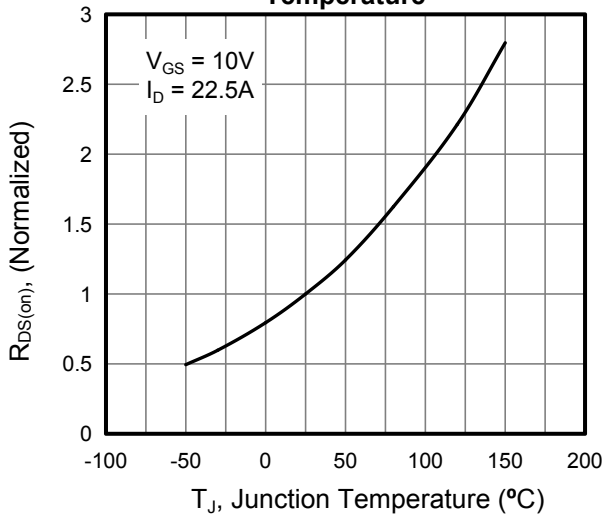

Figure 8. Breakdown voltage vs. Junction Temperature

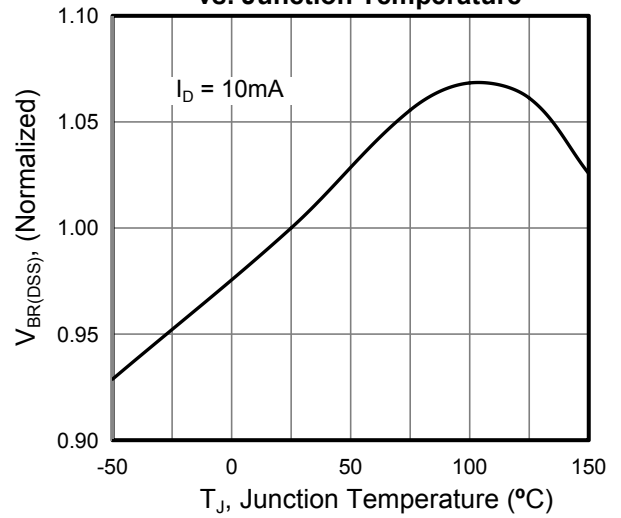

Figure 9. Transient Thermal Impedance For TO-263/TO-220/TO-247

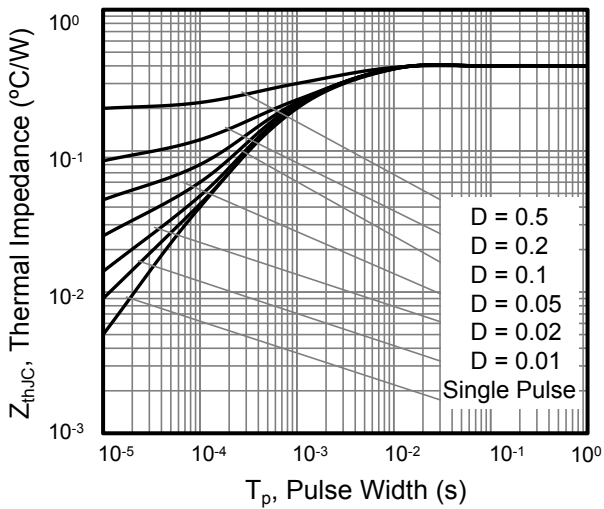

Figure 10. Safe Operation Area For TO-263/TO-220/TO-247

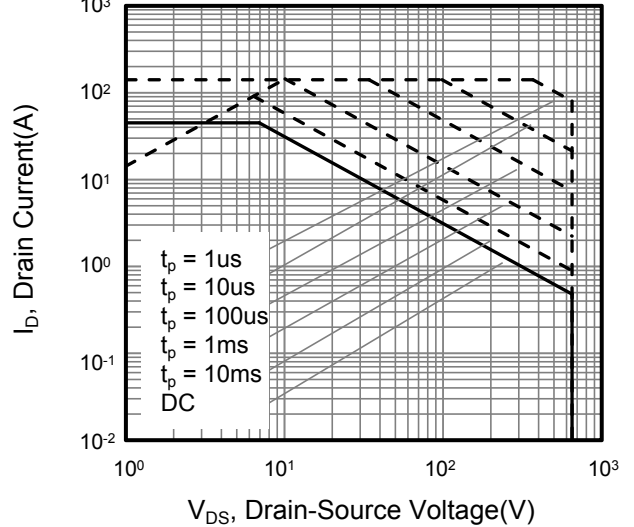

Figure 11. Typ. Coss Stored Energy

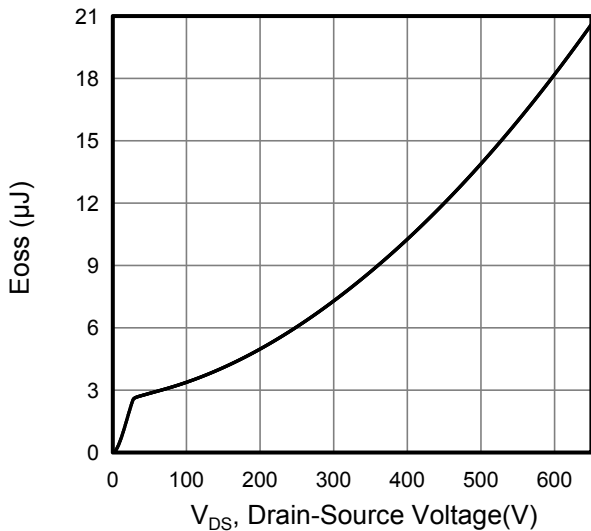

Figure A: Gate Charge Test Circuit and Waveform

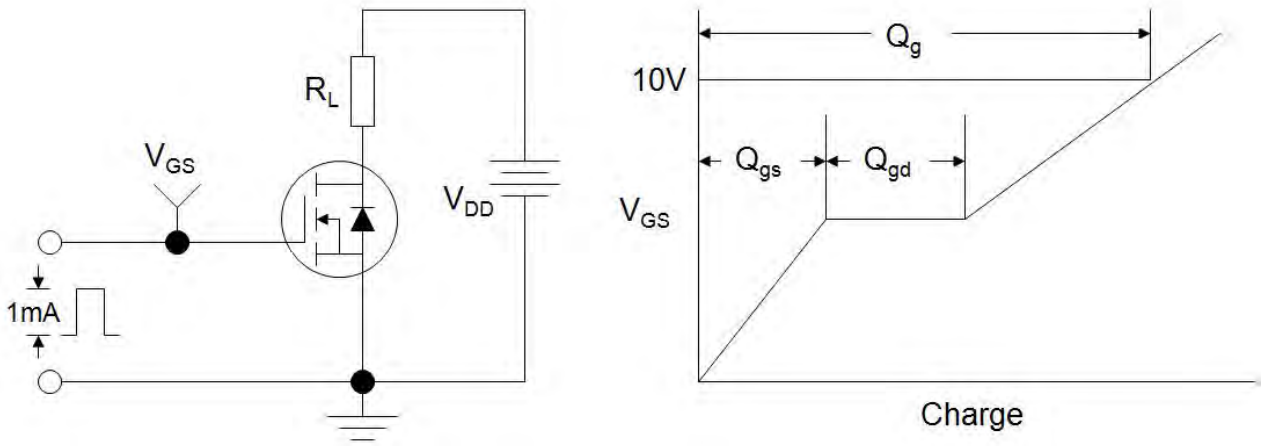

Figure B: Resistive Switching Test Circuit and Waveform

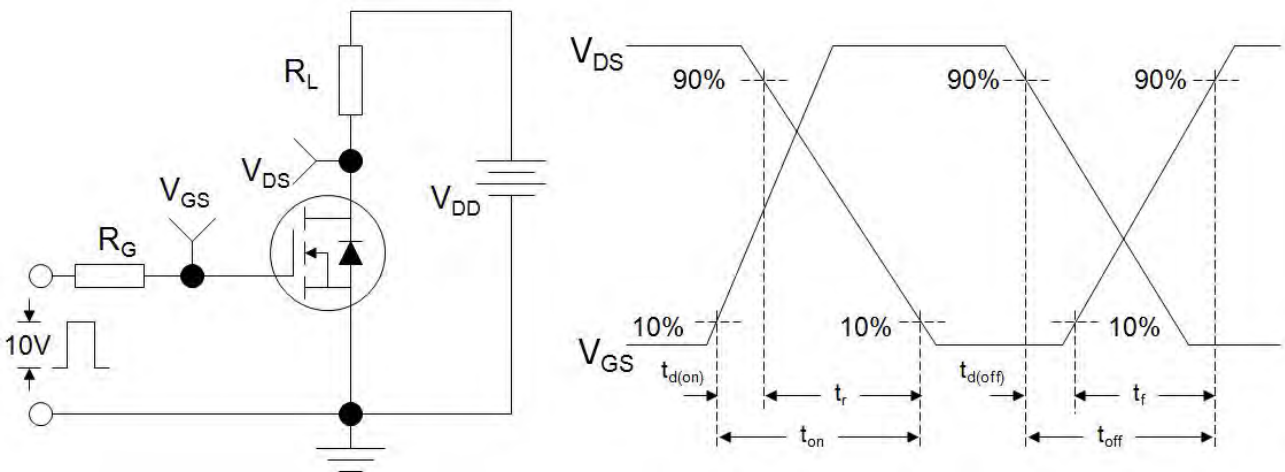
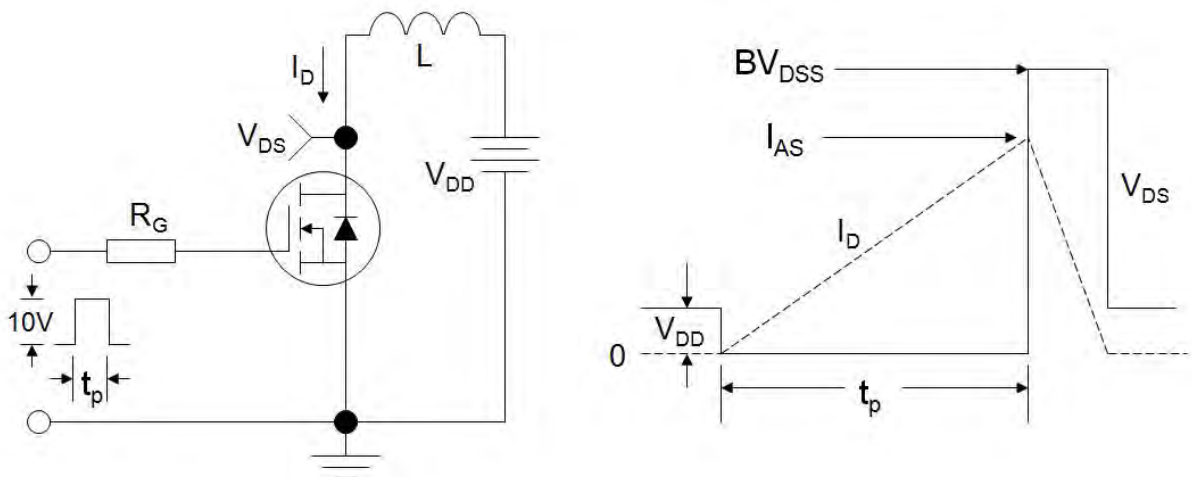
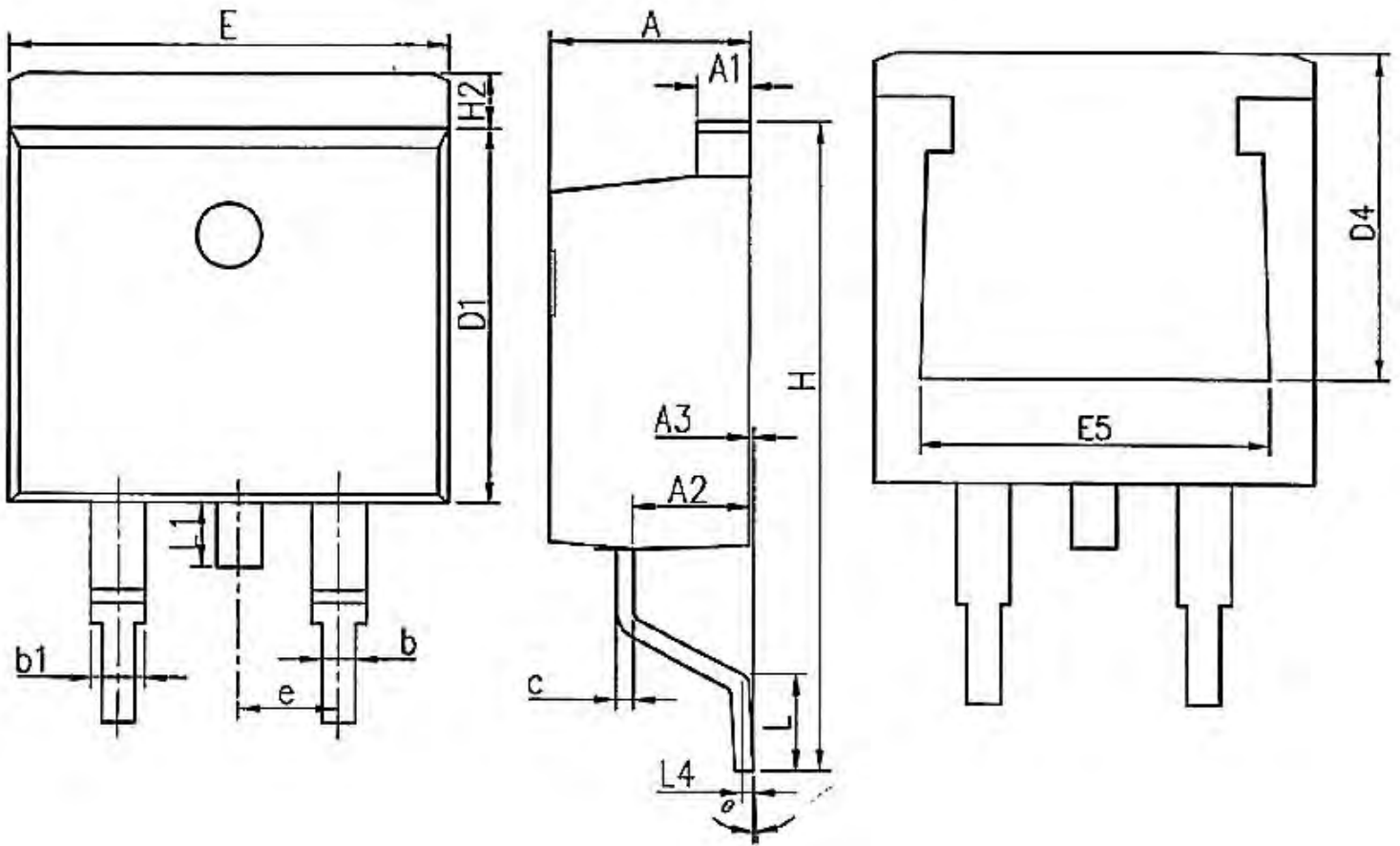

Figure C: Unclamped Inductive Switching Test Circuit and Waveform



TO-263



Unit:mm			
Symbol	Min.	Nom	Max.
A	4.37	4.57	4.77
A1	1.22	1.27	1.42
A2	2.49	2.69	2.89
A3	0.00	0.13	0.25
b	0.70	0.81	0.96
b1	1.17	1.27	1.47
c	0.30	0.38	0.53
D1	8.50	8.70	8.90
D4	6.60	-	-

Unit:mm			
Symbol	Min.	Nom	Max.
E	9.86	10.16	10.36
E5	7.06	-	-
e	2.54BSC		
H	14.70	15.10	15.50
H2	1.07	1.27	1.47
L	2.00	2.30	2.60
L1	1.40	1.55	1.70
L4	0.25BSC		
theta	0°	5°	9°

TO-220

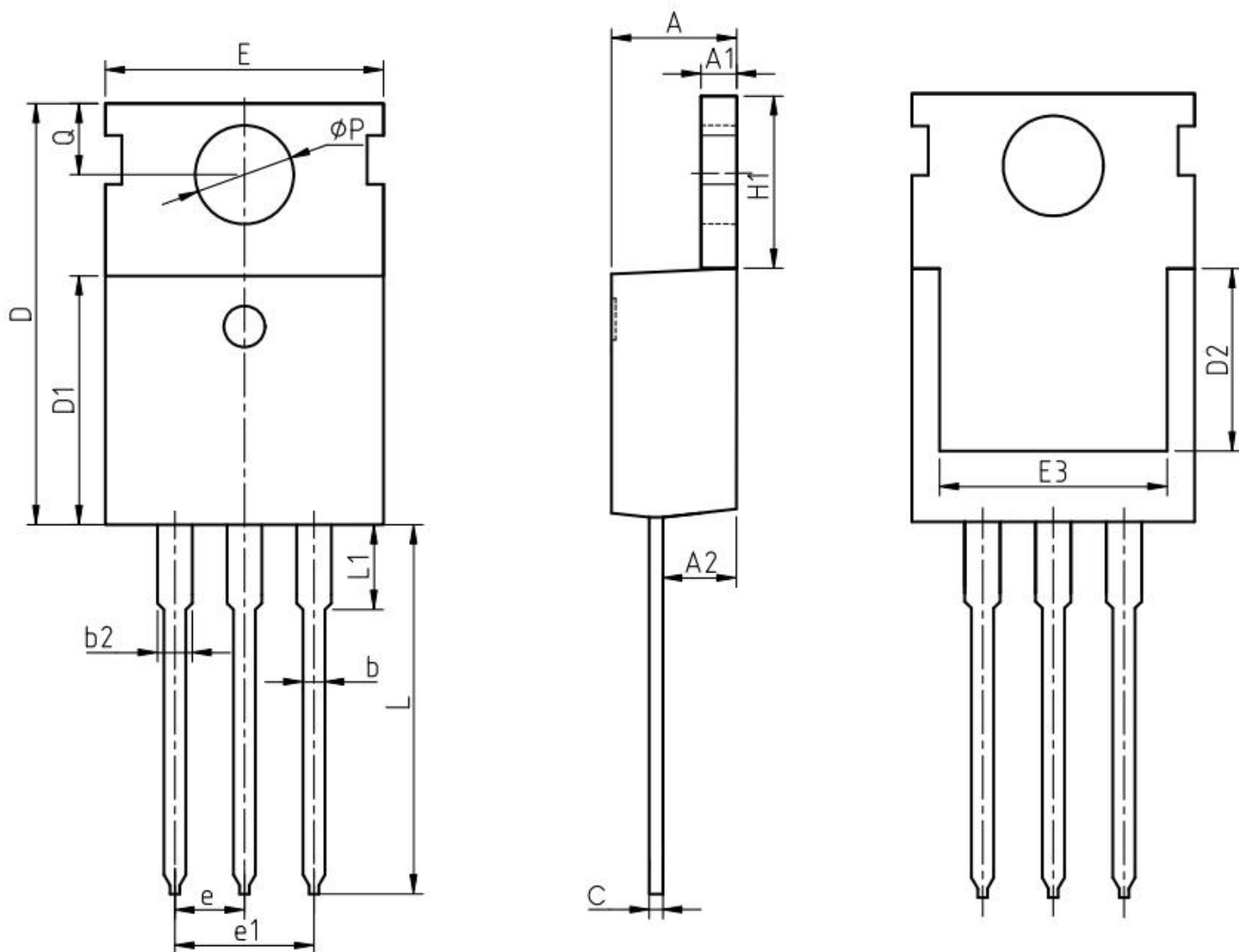

Unit:mm			
Symbol	Min.	Nom	Max.
A	4.37	4.57	4.77
A1	1.25	1.30	1.40
A2	2.20	2.40	2.60
b	0.70	0.80	0.95
b2	1.17	1.27	1.47
c	0.45	0.50	0.60
D	15.10	15.60	16.10
D1	8.80	9.10	9.40
D2	5.50	-	-

Unit:mm			
Symbol	Min.	Nom	Max.
E	9.70	10.00	10.30
E3	7.00	-	-
e	2.54 BSC		
e1	5.08 BSC		
H1	6.25	6.50	6.85
L	12.75	13.50	13.80
L1	-	3.10	3.40
phi P	3.40	3.60	3.80
Q	2.60	2.80	3.00

TO-247

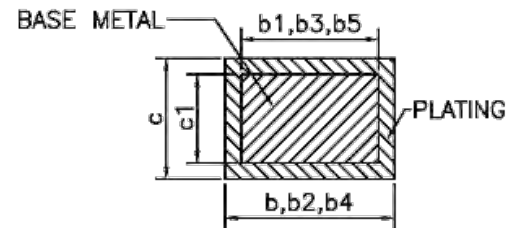
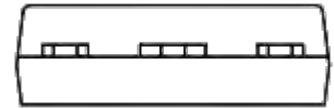
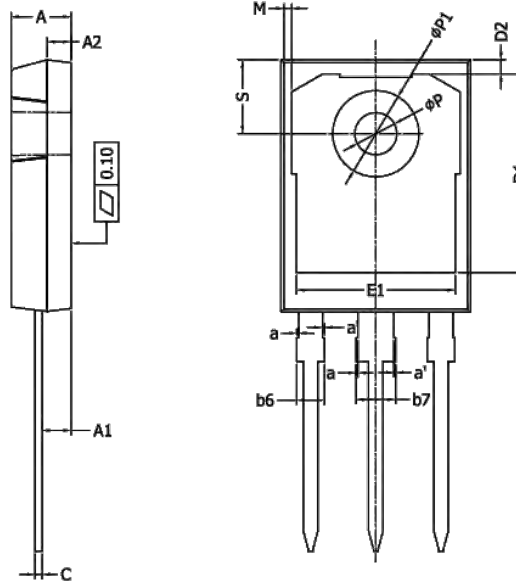
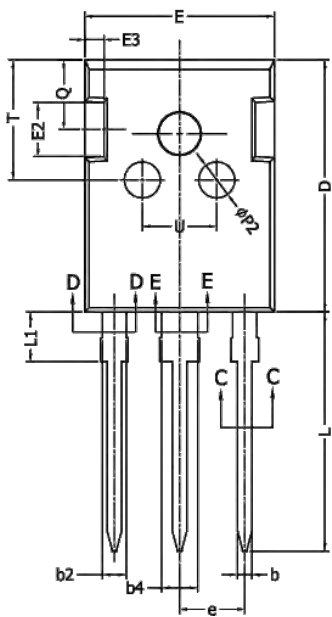

SYMBOL	MIN	NOM	MAX
A	4.90	5.00	5.10
A1	2.31	2.41	2.51
A2	1.90	2.00	2.10
a	0	---	0.15
a'	0	---	0.15
b	1.16	---	1.26
b1	1.15	1.2	1.22
b2	1.96	---	2.06
b3	1.95	2.00	2.02
b4	2.96	---	3.06
b5	2.96	3.00	3.02
b6	---	---	2.25
b7	---	---	3.25
c	0.59	---	0.66
c1	0.58	0.60	0.62
D	20.90	21.00	21.10
D1	16.25	16.55	16.85
D2	1.05	1.17	1.35
E	15.70	15.80	15.90
E1	13.10	13.30	13.50
E2	4.40	4.50	4.60
E3	2.40	2.50	2.60
e	5.436 BSC		
L	19.80	19.92	20.10
L1	---	---	4.30
M	0.35	---	0.95
P	3.40	3.50	3.60
P1	7.00	---	7.40
P2	2.40	2.50	2.60
Q	5.60	---	6.00
S	6.05	6.15	6.25
T	9.80	---	10.20
U	6.00	---	6.40

X-ON Electronics

Largest Supplier of Electrical and Electronic Components

Click to view similar products for [MOSFET](#) category:

Click to view products by [Tokmas](#) manufacturer:

Other Similar products are found below :

[614233C](#) [648584F](#) [IRFD120](#) [IRFF430](#) [JANTX2N5237](#) [2N7000](#) [FCA20N60_F109](#) [FDZ595PZ](#) [AOD464](#) [2SK2267\(Q\)](#) [2SK2545\(Q,T\)](#)
[405094E](#) [423220D](#) [MIC4420CM-TR](#) [VN1206L](#) [614234A](#) [715780A](#) [SSM6J414TU,LF\(T](#) [751625C](#) [PSMN4R2-30MLD](#)
[TK31J60W5,S1VQ\(O](#) [2SK2614\(Te16L1,Q\)](#) [DMN1017UCP3-7](#) [EFC2J004NUZTDG](#) [FCAB21350L1](#) [P85W28HP2F-7071](#) [DMN1053UCP4-7](#)
[NTE2384](#) [NTE2969](#) [NTE6400A](#) [DMN2080UCB4-7](#) [DMN61D9UWQ-13](#) [US6M2GTR](#) [DMN31D5UDJ-7](#) [SSM6P54TU,LF](#) [DMP22D4UFO-](#)
[7B](#) [IPS60R3K4CEAKMA1](#) [DMN1006UCA6-7](#) [DMN16M9UCA6-7](#) [STF5N65M6](#) [STU5N65M6](#) [C3M0021120D](#) [DMN13M9UCA6-7](#)
[BSS340NWH6327XTSA1](#) [MCM3400A-TP](#) [DMTH10H4M6SPS-13](#) [IRF40SC240ARMA1](#) [IPS60R1K0PFD7SAKMA1](#)
[IPS60R360PFD7SAKMA1](#) [IPS60R600PFD7SAKMA1](#)