

N-Channel Enhancement Mode MOSFET

1. Product Information

1.1 Features

Surface-mounted package
Super Trench
Advanced trench cell design
MSL1

1.2 Applications

BMS
Drones
High power inverter system
Light electric vehicles

1.3 Quick reference

$BV \geq 85 \text{ V}$
 $P_{tot} \leq 500 \text{ W}$
 $I_D \leq 300 \text{ A}$
 $R_{DS(ON)} \leq 1.4 \text{ m}\Omega @ V_{GS} = 10 \text{ V}$

2. Pin Description

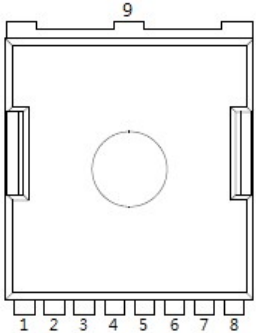
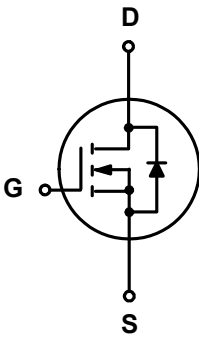
Pin	Description	Simplified Outline	Symbol
1	Gate(G)	 <p>Top View TOLL</p>	
2,3,4,5,6,7,8	Source(S)		
9	Drain(D)		

3. Limiting Values

Symbol	Parameter	Conditions	Min	Max	Unit
V _{DS}	Drain-Source Voltage	T _C = 25 °C	85	-	V
V _{GS}	Gate-Source Voltage	T _C = 25 °C	-	±20	V
I _D	Drain Current (DC)	T _C = 25 °C, V _{GS} = 10 V	-	300	A
		T _C = 100 °C, V _{GS} = 10 V	-	267	A
I _{DM} *	Drain Current (Pulsed)	T _C = 25 °C, V _{GS} = 10 V	-	1200	A
P _{tot}	Drain power dissipation	T _C = 25 °C	-	500	W
T _{stg}	Storage Temperature		-55	150	°C
T _J	Junction Temperature		-	150	°C
I _S	Continuous-Source Current	T _C = 25 °C	-	300	A
E _{AS}	Single Pulsed Avalanche Energy	V _{DD} =40V , L=0.5mH	-	2800	mJ
R _{θJA} **	Thermal Resistance- Junction to Ambient		-	32.8	°C/W
R _{θJC} **	Thermal Resistance- Junction to Case		-	0.45	

Notes :

- * Pulse width ≤ 300 μs, duty cycle ≤ 2 %
- ** Surface Mounted on minimum footprint pad area.
- *** Limited by bonding wire

4. Ordering Code

Product Name	Package	Reel Size	Tape width	Quantity	Note
FDBL86361-F085	TOLL-8L			2000	

Note: NHCX defines " Green " as lead-free (RoHS compliant) and halogen free (Br or Cl does not exceed 900 ppm by weight in homogeneous material and total of Br and Cl does not exceed 1500 ppm by weight; Follow IEC 61249-2-21 and IPC / JEDEC J-STD-020C)

5. Electrical Characteristics ($T_A=25^\circ$ Unless Otherwise Noted)

Symbol	Parameter	Conditions	Min	Typ	Max	Unit
Static Characteristics						
BV_{DSS}	Drain-Source Breakdown Voltage	$V_{GS} = 0\text{ V}, I_{DS} = 250\ \mu\text{A}$	85	95	-	V
$V_{GS(th)}$	Gate Threshold Voltage	$V_{DS} = V_{GS}, I_{DS} = 250\ \mu\text{A}$	2	-	4	V
I_{DSS}	Drain Leakage Current	$V_{DS} = 80\text{ V}, V_{GS} = 0\text{ V}$	-	-	1	μA
I_{GSS}	Gate Leakage Current	$V_{GS} = 0\text{ V}, V_{GS} = \pm 20\text{ V}$	-	-	± 100	nA
$R_{DS(ON)}^a$	On-State Resistance	$V_{GS} = 10.0\text{ V}, I_{DS} = 50\text{ A}$	-	1.2	1.4	$\text{m}\Omega$
Diode Characteristics						
V_{SD}^a	Diode Forward Voltage	$I_{SD} = 50\text{ A}, V_{GS} = 0\text{ V}$	-	-	1.2	V
t_{rr}	Reverse Recovery Time	$I_{DS} = 50\text{ A}, V_{GS} = 0\text{ V}$ $dI_{SD}/dt = 100\text{ A}/\mu\text{s}$	-	120	-	nS
Q_{rr}	Reverse Recovery Charge		-	360	-	nC
Dynamic Characteristics^b						
C_{iss}	Input Capacitance	$V_{GS} = 0\text{ V}, V_{DS} = 50\text{ V}$ Frequency = 1 MHz	-	14490	-	pF
C_{oss}	Output Capacitance		-	2350	-	
C_{rss}	Reverse Transfer Capacitance		-	472	-	
$t_d(on)$	Turn-on Delay Time	$V_{DS} = 50\text{ V}, V_{GEN} = 10\text{ V},$ $R_G = 4.5\ \Omega, R_L = 1\ \Omega,$ $I_{DS} = 50\text{ A}$	-	39	-	nS
t_r	Turn-on Rise Time		-	122	-	
$t_d(off)$	Turn-off Delay Time		-	115	-	
t_f	Turn-off Fall Time		-	137	-	
Gate Charge Characteristics^b						
Q_g	Total Gate Charge	$V_{DS} = 50\text{ V}, V_{GS} = 10\text{ V},$ $I_{DS} = 50\text{ A}$	-	240	-	nC
Q_{gs}	Gate-Source Charge		-	56	-	
Q_{gd}	Gate-Drain Charge		-	60	-	

Notes :

a : Pulse test ; pulse width $\leq 300\ \mu\text{s}$, duty cycle $\leq 2\%$

b : Guaranteed by design, not subject to production testing

6. Typical Characteristics

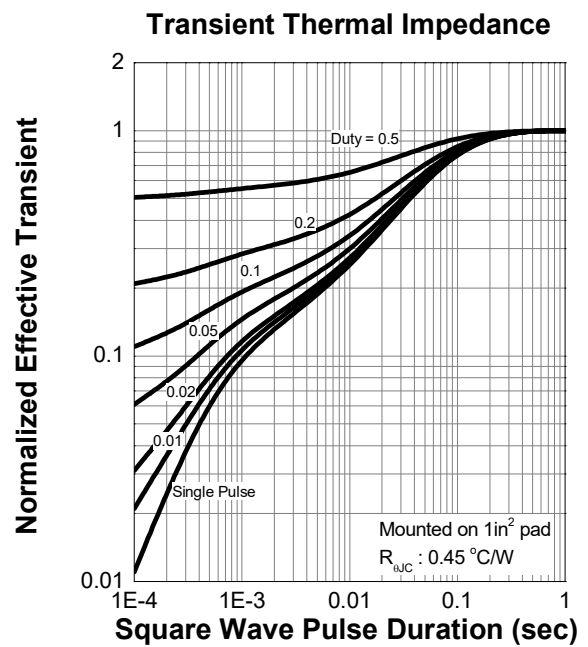
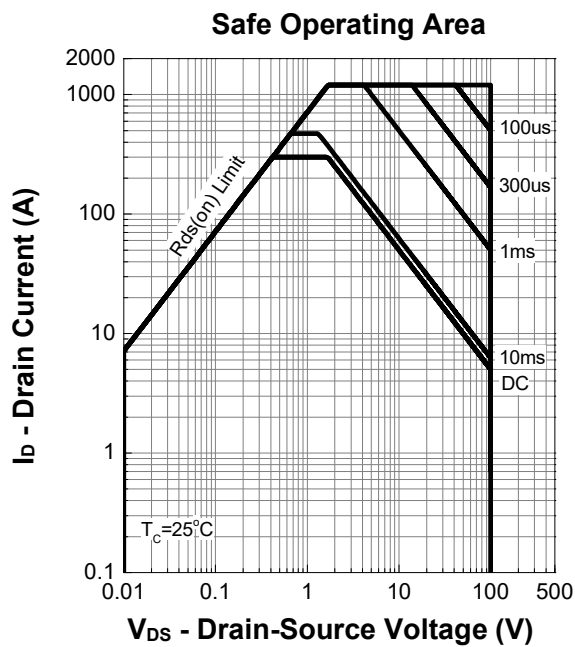
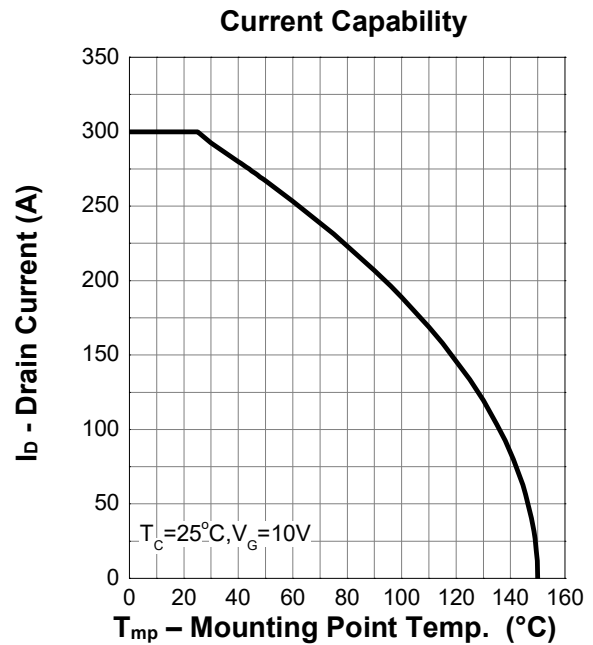
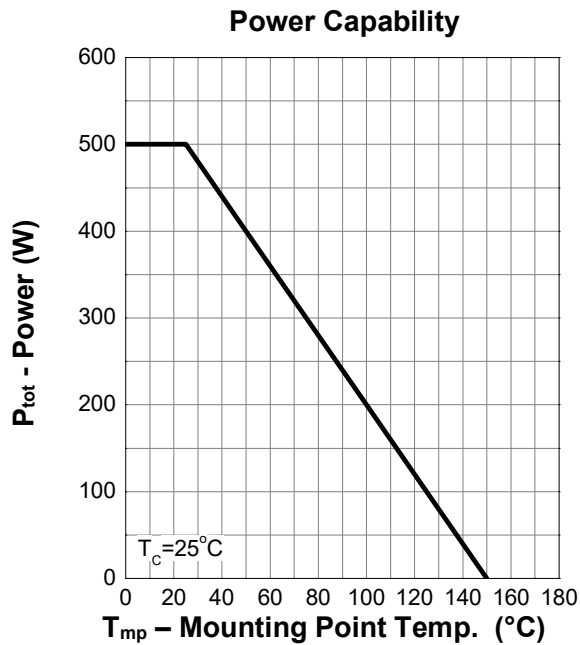

6. Typical Characteristics (cont.)

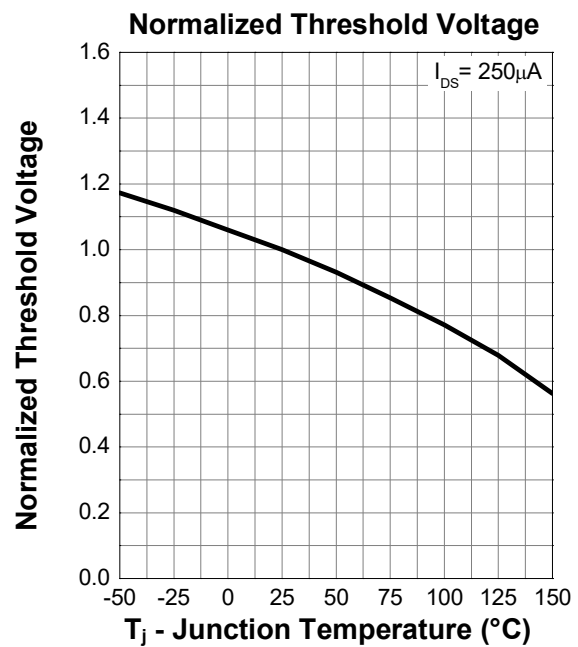
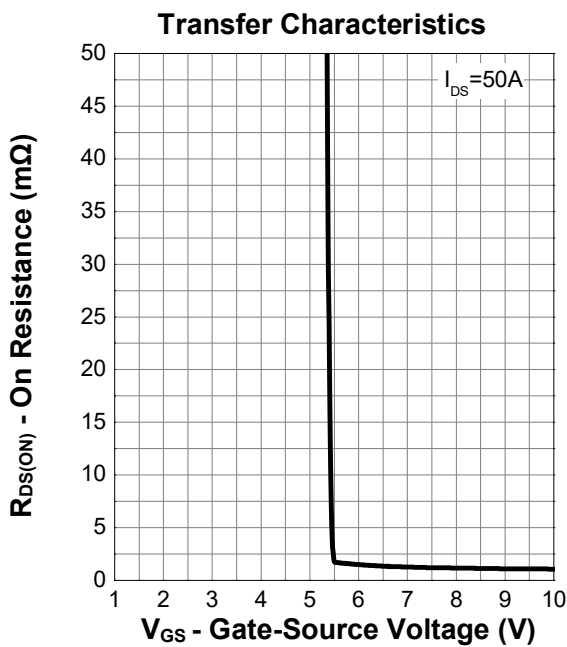
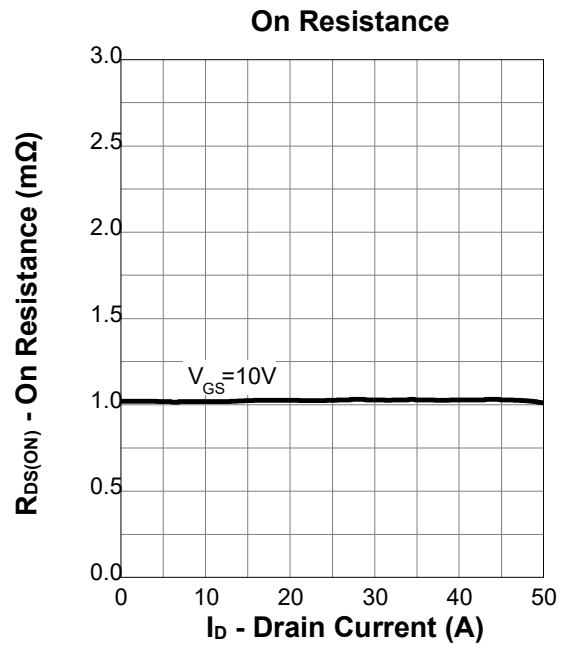
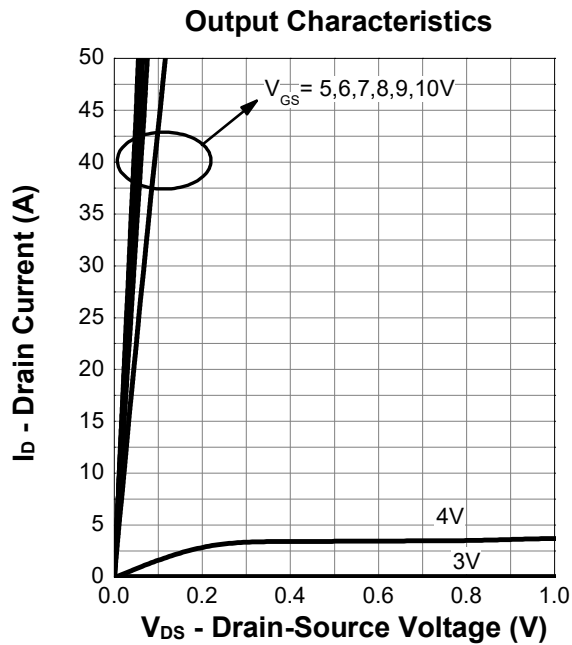

6. Typical Characteristics (cont.)

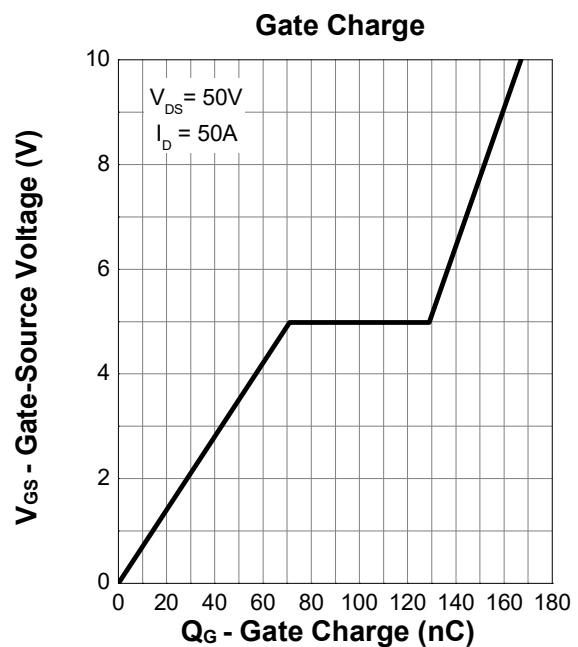
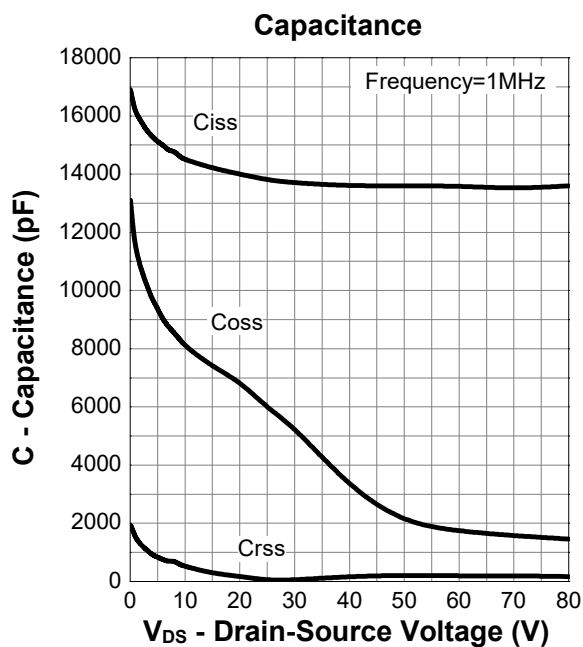
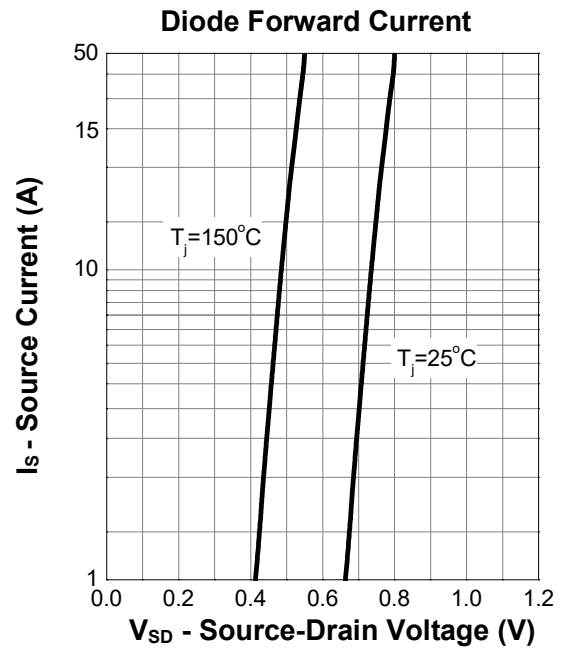
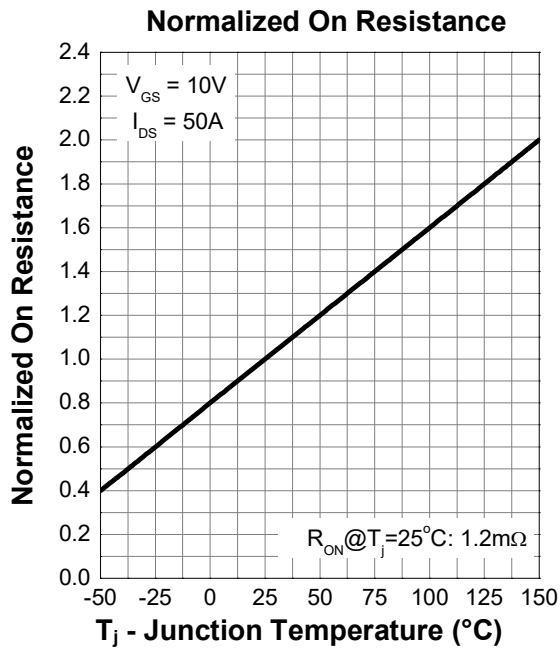

7. Package Dimensions

TOLL-8L Package

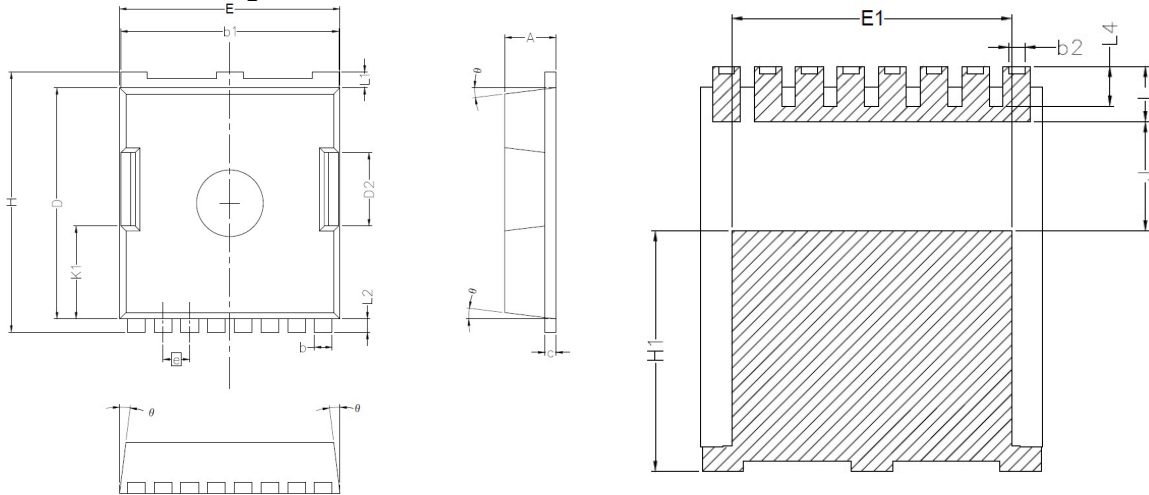

Symbol	Dimensions In Millimeters	
	MIN.	MAX.
A	2.20	2.40
b	0.70	0.90
b1	9.70	9.90
b2	0.42	0.50
c	0.40	0.60
D	10.28	10.58
D2	3.10	3.50
E	9.70	10.10
E1	7.90	8.30
e	1.20BSC	
H	11.48	11.88
H1	6.75	7.15
N	8	
J	3.00	3.30
K1	3.98	4.38
L	1.40	1.80
L1	0.60	0.80
L2	0.50	0.70
L4	1.00	1.30
θ	4°	10°

X-ON Electronics

Largest Supplier of Electrical and Electronic Components

Click to view similar products for [MOSFET](#) category:

Click to view products by [Tokmas](#) manufacturer:

Other Similar products are found below :

[IRFD120](#) [JANTX2N5237](#) [BUK455-60A/B](#) [MIC4420CM-TR](#) [VN1206L](#) [NDP4060](#) [SI4482DY](#) [IPS70R2K0CEAKMA1](#) [SQD23N06-31L-GE3](#)
[TK16J60W,S1VQ\(O](#) [2SK2614\(TE16L1,Q\)](#) [DMN1017UCP3-7](#) [DMN1053UCP4-7](#) [SQJ469EP-T1-GE3](#) [NTE2384](#) [DMC2700UDMQ-7](#)
[DMN2080UCB4-7](#) [DMN61D9UWQ-13](#) [US6M2GTR](#) [DMN31D5UDJ-7](#) [DMP22D4UFO-7B](#) [DMN1006UCA6-7](#) [DMN16M9UCA6-7](#)
[STF5N65M6](#) [IRF40H233XTMA1](#) [STU5N65M6](#) [DMN6022SSD-13](#) [DMN13M9UCA6-7](#) [DMTH10H4M6SPS-13](#) [DMN2990UFB-7B](#)
[IPB80P04P405ATMA2](#) [2N7002W-G](#) [MCAC30N06Y-TP](#) [MCQ7328-TP](#) [BXP7N65D](#) [BXP4N65F](#) [AOL1454G](#) [WMJ80N60C4](#) [BXP2N20L](#)
[BXP2N65D](#) [BXT1150N10J](#) [BXT1700P06M](#) [TSM60NB380CP ROG](#) [RQ7L055BGTCR](#) [DMNH15H110SK3-13](#) [SLF10N65ABV2](#)
[BSO203SP](#) [BSO211P](#) [IPA60R230P6](#) [IPA60R460CE](#)