

3 TERMINAL 1.5A POSITIVE VOLTAGE REGULATORS

FEATURES

- * Output current up to 1.5A
- * 5V;6V;8V;9V;10V;12V;15V;18V;24V output voltage available
- * Thermal overload protection
- * Short circuit protection
- * Output transistor SOA protection

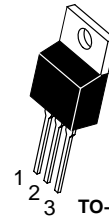

Heatsink surface connected to Pin 2.

TO-220-3

MC7805CT

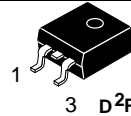

D²PAK-3

Pin 1. Input
2. Ground
3. Output

L7812ABD2T



DPAK-3

MC7805BDT L7805CDT
MC7812BDTR L78M12ABDT
MC7815CDTR
L78M10ABDT

STANDARD APPLICATION

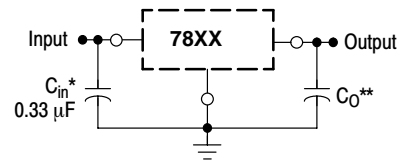

BLOCK DIAGRAM

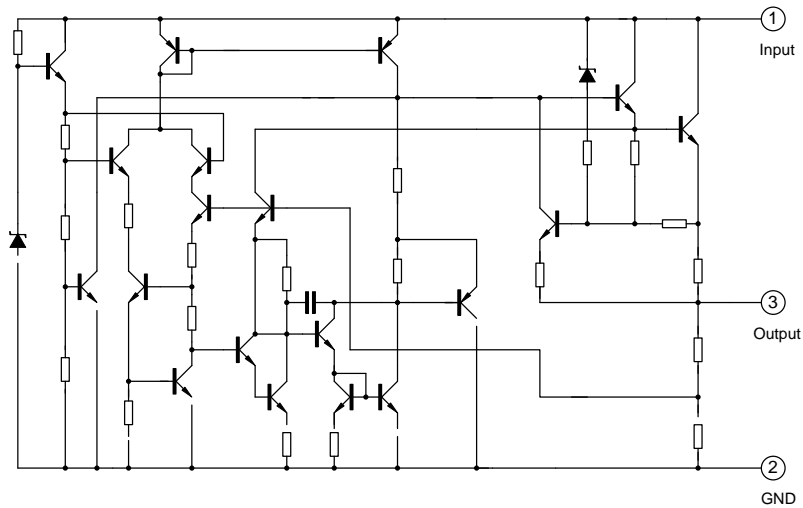

ABSOLUTE MAXIMUM RATINGS $T_a = 25^\circ\text{C}$

Characteristic	Symbol	Value	Unit
Input voltage (for $V_o=5\text{V}$ to 18V) (for $V_o=24\text{V}$)	V_i	35 40	V
Operating Temperature	T_{opr}	-40~ +125	$^\circ\text{C}$
Storage Temperature	T_{stg}	-65 ~ +150	$^\circ\text{C}$

7805 ELECTRICAL CHARACTERISTICS

 (Refer to test circuits, $0 < T_j < 125^\circ\text{C}$, $I_o=500\text{mA}$, $V_i=10\text{V}$, $C_i=0.33\mu\text{F}$, $C_o=0.1\mu\text{F}$, unless otherwise specified)

Characteristic	Symbol	Test Conditions	Min	Typ	Max	Units
Output voltage	V_o	$T_j=25^\circ\text{C}$	4.8	5.0	5.2	V
		$5.0\text{mA} < I_o < 1.0\text{A}$, $P_D < 15\text{W}$ $V_i=7.5\text{V}$ to 20V	4.75	5.00	5.25	V
Line regulation	ΔV_o	$T_j=25^\circ\text{C}$, $V_i=7.5\text{V}$ to 25V	-	4.0	100	mV
		$T_j=25^\circ\text{C}$, $V_i=8\text{V}$ to 12V	-	1.6	50	mV
Load regulation	ΔV_o	$T_j=25^\circ\text{C}$, $I_o=5.0\text{mA}$ to 1.5A	-	9	100	mV
		$T_j=25^\circ\text{C}$, $I_o=250\text{mA}$ to 750mA	-	4	50	mV
Quiescent current	I_q	$T_j=25^\circ\text{C}$	-	5.0	8	mA
Quiescent current change	ΔI_q	$I_o=5\text{mA}$ to 1.0A	-	-	0.5	mA
		$V_i=8\text{V}$ to 25V	-	-	0.8	mA
Output voltage drift	$\Delta V_o/\Delta T$	$I_o=5\text{mA}$	-	0.8	-	mV/ $^\circ\text{C}$
Output noise voltage	V_N	$f=10\text{Hz}$ to 100kHz , $T_a=25^\circ\text{C}$	-	42	-	$\mu\text{V}/V_o$
Ripple rejection	RR	$f=120\text{Hz}$, $V_i=8\text{V}$ to 18V	62	73	-	dB
Dropout voltage	V_o	$I_o=1.0\text{A}$, $T_j=25^\circ\text{C}$	-	2	-	V
Output resistance	R_o	$f=1\text{kHz}$	-	15	-	$\text{m}\Omega$
Short circuit current	I_{sc}	$V_i=35\text{V}$, $T_a=25^\circ\text{C}$	-	230	-	mA
peak current	I_{pk}	$T_j=25^\circ\text{C}$	-	2.2	-	A

7806 ELECTRICAL CHARACTERISTICS

 (Refer to test circuits, $0 < T_j < 125^\circ\text{C}$, $I_o = 500\text{mA}$, $V_i = 11\text{V}$, $C_i = 0.33\mu\text{F}$, $C_o = 0.1\mu\text{F}$, unless otherwise specified)

Characteristic	Symbol	Test Conditions	Min	Typ	Max	Units
Output voltage	V_o	$T_j = 25^\circ\text{C}$	5.75	6.00	6.25	V
		$5.0\text{mA} < I_o < 1.0\text{A}$, $P_D < 15\text{W}$ $V_i = 8.5\text{V to } 21\text{V}$	5.7	6.0	6.3	V
Line regulation	ΔV_o	$T_j = 25^\circ\text{C}$, $V_i = 8.5\text{V to } 25\text{V}$	-	5	120	mV
		$T_j = 25^\circ\text{C}$, $V_i = 9\text{V to } 13\text{V}$	-	1.8	60	mV
Load regulation	ΔV_o	$T_j = 25^\circ\text{C}$, $I_o = 5.0\text{mA to } 1.5\text{A}$	-	9	130	mV
		$T_j = 25^\circ\text{C}$, $I_o = 250\text{mA to } 750\text{mA}$	-	4	60	mV
Quiescent current	I_q	$T_j = 25^\circ\text{C}$	-	5.0	8	mA
Quiescent current change	ΔI_q	$I_o = 5\text{mA to } 1.0\text{A}$	-	-	0.5	mA
		$V_i = 9\text{V to } 25\text{V}$	-	-	0.8	mA
Output voltage drift	$\Delta V_o / \Delta T$	$I_o = 5\text{mA}$	-	0.9	-	mV/ $^\circ\text{C}$
Output noise voltage	V_N	$f = 10\text{Hz to } 100\text{kHz}$, $T_a = 25^\circ\text{C}$	-	45	-	$\mu\text{V}/V_o$
Ripple rejection	RR	$f = 120\text{Hz}$, $V_i = 9\text{V to } 19\text{V}$	59	70	-	dB
Dropout voltage	V_o	$I_o = 1.0\text{A}$, $T_j = 25^\circ\text{C}$	-	2	-	V
Output resistance	R_o	$f = 1\text{kHz}$	-	19	-	$\text{m}\Omega$
Short circuit current	I_{sc}	$V_i = 35\text{V}$, $T_a = 25^\circ\text{C}$	-	230	-	mA
peak current	I_{pk}	$T_j = 25^\circ\text{C}$	-	2.2	-	A

7808 ELECTRICAL CHARACTERISTICS

 (Refer to test circuits, $0 < T_j < 125^\circ\text{C}$, $I_o = 500\text{mA}$, $V_i = 14\text{V}$, $C_i = 0.33\mu\text{F}$, $C_o = 0.1\mu\text{F}$, unless otherwise specified)

Characteristic	Symbol	Test Conditions	Min	Typ	Max	Units
Output voltage	V_o	$T_j = 25^\circ\text{C}$	7.7	8.0	8.3	V
		$5.0\text{mA} < I_o < 1.0\text{A}$, $P_D < 15\text{W}$ $V_i = 11\text{V to } 23\text{V}$	7.6	8.0	8.4	V
Line regulation	ΔV_o	$T_j = 25^\circ\text{C}$, $V_i = 10.5\text{V to } 25\text{V}$	-	5.0	160	mV
		$T_j = 25^\circ\text{C}$, $V_i = 11\text{V to } 17\text{V}$	-	2.0	80	mV
Load regulation	ΔV_o	$T_j = 25^\circ\text{C}$, $I_o = 5.0\text{mA to } 1.5\text{A}$	-	10	160	mV
		$T_j = 25^\circ\text{C}$, $I_o = 250\text{mA to } 750\text{mA}$	-	5.0	80	mV
Quiescent current	I_q	$T_j = 25^\circ\text{C}$	-	5.0	8	mA
Quiescent current change	ΔI_q	$I_o = 5\text{mA to } 1.0\text{A}$	-	-	0.5	mA
		$V_i = 11\text{V to } 25\text{V}$	-	-	0.8	mA
Output voltage drift	$\Delta V_o / \Delta T$	$I_o = 5\text{mA}$	-	1.2	-	mV/ $^\circ\text{C}$
Output noise voltage	V_N	$f = 10\text{Hz to } 100\text{kHz}$, $T_a = 25^\circ\text{C}$	-	52	-	$\mu\text{V}/V_o$
Ripple rejection	RR	$f = 120\text{Hz}$, $V_i = 11.5\text{V to } 21.5\text{V}$	56	67	-	dB
Dropout voltage	V_o	$I_o = 1.0\text{A}$, $T_j = 25^\circ\text{C}$	-	2	-	V
Output resistance	R_o	$f = 1\text{kHz}$	-	17	-	$\text{m}\Omega$
Short circuit current	I_{sc}	$V_i = 35\text{V}$, $T_a = 25^\circ\text{C}$	-	230	-	mA
peak current	I_{pk}	$T_j = 25^\circ\text{C}$	-	2.2	-	A

7809 ELECTRICAL CHARACTERISTICS

 (Refer to test circuits, $0 < T_j < 125^\circ\text{C}$, $I_o = 500\text{mA}$, $V_i = 15\text{V}$, $C_i = 0.33\mu\text{F}$, $C_o = 0.1\mu\text{F}$, unless otherwise specified)

Characteristic	Symbol	Test Conditions	Min	Typ	Max	Units
Output voltage	V_o	$T_j = 25^\circ\text{C}$	8.65	9.00	9.35	V
		$5.0\text{mA} < I_o < 1.0\text{A}$, $P_D < 15\text{W}$ $V_i = 11.5\text{V}$ to 24V	8.6	9.0	9.4	V
Line regulation	ΔV_o	$T_j = 25^\circ\text{C}$, $V_i = 11.5\text{V}$ to 25V	-	6	180	mV
		$T_j = 25^\circ\text{C}$, $V_i = 12\text{V}$ to 25V	-	2	90	mV
Load regulation	ΔV_o	$T_j = 25^\circ\text{C}$, $I_o = 5.0\text{mA}$ to 1.5A	-	12	180	mV
		$T_j = 25^\circ\text{C}$, $I_o = 250\text{mA}$ to 750mA	-	5	90	mV
Quiescent current	I_q	$T_j = 25^\circ\text{C}$	-	5.0	8	mA
Quiescent current change	ΔI_q	$I_o = 5\text{mA}$ to 1.0A	-	-	0.5	mA
		$V_i = 12\text{V}$ to 26V	-	-	0.8	mA
Output voltage drift	$\Delta V_o / \Delta T$	$I_o = 5\text{mA}$	-	1.3	-	mV/ $^\circ\text{C}$
Output noise voltage	V_N	$f = 10\text{Hz}$ to 100kHz , $T_a = 25^\circ\text{C}$	-	58	-	$\mu\text{V}/V_o$
Ripple rejection	RR	$f = 120\text{Hz}$, $V_i = 13\text{V}$ to 23V	55	66	-	dB
Dropout voltage	V_o	$I_o = 1.0\text{A}$, $T_j = 25^\circ\text{C}$	-	2	-	V
Output resistance	R_o	$f = 1\text{kHz}$	-	15	-	$\text{m}\Omega$
Short circuit current	I_{sc}	$V_i = 35\text{V}$, $T_a = 25^\circ\text{C}$	-	230	-	mA
peak current	I_{pk}	$T_j = 25^\circ\text{C}$	-	2.2	-	A

7810 ELECTRICAL CHARACTERISTICS

 (Refer to test circuits, $0 < T_j < 125^\circ\text{C}$, $I_o = 500\text{mA}$, $V_i = 16\text{V}$, $C_i = 0.33\mu\text{F}$, $C_o = 0.1\mu\text{F}$, unless otherwise specified)

Characteristic	Symbol	Test Conditions	Min	Typ	Max	Units
Output voltage	V_o	$T_j = 25^\circ\text{C}$	9.6	10	10.4	V
		$5.0\text{mA} < I_o < 1.0\text{A}$, $P_D < 15\text{W}$ $V_i = 12.5\text{V}$ to 25V	9.5	10	10.5	V
Line regulation	ΔV_o	$T_j = 25^\circ\text{C}$, $V_i = 12.5\text{V}$ to 25V	-	8	200	mV
		$T_j = 25^\circ\text{C}$, $V_i = 13\text{V}$ to 20V	-	3	100	mV
Load regulation	ΔV_o	$T_j = 25^\circ\text{C}$, $I_o = 5.0\text{mA}$ to 1.5A	-	12	200	mV
		$T_j = 25^\circ\text{C}$, $I_o = 250\text{mA}$ to 750mA	-	5	100	mV
Quiescent current	I_q	$T_j = 25^\circ\text{C}$	-	5.0	8	mA
Quiescent current change	ΔI_q	$I_o = 5\text{mA}$ to 1.0A	-	-	0.5	mA
		$V_i = 13\text{V}$ to 29V	-	-	0.8	mA
Output voltage drift	$\Delta V_o / \Delta T$	$I_o = 5\text{mA}$	-	1.4	-	mV/ $^\circ\text{C}$
Output noise voltage	V_N	$f = 10\text{Hz}$ to 100kHz , $T_a = 25^\circ\text{C}$	-	58	-	$\mu\text{V}/V_o$
Ripple rejection	RR	$f = 120\text{Hz}$, $V_i = 14\text{V}$ to 24V	54	65	-	dB
Dropout voltage	V_o	$I_o = 1.0\text{A}$, $T_j = 25^\circ\text{C}$	-	2	-	V
Output resistance	R_o	$f = 1\text{kHz}$	-	17	-	$\text{m}\Omega$
Short circuit current	I_{sc}	$V_i = 35\text{V}$, $T_a = 25^\circ\text{C}$	-	230	-	mA
peak current	I_{pk}	$T_j = 25^\circ\text{C}$	-	2.2	-	A

7812 ELECTRICAL CHARACTERISTICS

 (Refer to test circuits, $0 < T_j < 125^\circ\text{C}$, $I_o = 500\text{mA}$, $V_i = 19\text{V}$, $C_i = 0.33\mu\text{F}$, $C_o = 0.1\mu\text{F}$, unless otherwise specified)

Characteristic	Symbol	Test Conditions	Min	Typ	Max	Units
Output voltage	V_o	$T_j = 25^\circ\text{C}$	11.5	12.0	12.5	V
		$5.0\text{mA} < I_o < 1.0\text{A}$, $P_D < 15\text{W}$ $V_i = 14.5\text{V}$ to 27V	11.4	12	12.6	V
Line regulation	ΔV_o	$T_j = 25^\circ\text{C}$, $V_i = 14.5\text{V}$ to 30V	-	10	240	mV
		$T_j = 25^\circ\text{C}$, $V_i = 16\text{V}$ to 22V	-	3	120	mV
Load regulation	ΔV_o	$T_j = 25^\circ\text{C}$, $I_o = 5.0\text{mA}$ to 1.5A	-	12	240	mV
		$T_j = 25^\circ\text{C}$, $I_o = 250\text{mA}$ to 750mA	-	5.0	120	mV
Quiescent current	I_q	$T_j = 25^\circ\text{C}$	-	5.1	8	mA
Quiescent current change	ΔI_q	$I_o = 5\text{mA}$ to 1.0A	-	-	0.5	mA
		$V_i = 15\text{V}$ to 30V	-	-	0.8	mA
Output voltage drift	$\Delta V_o / \Delta T$	$I_o = 5\text{mA}$	-	1.7	-	mV/ $^\circ\text{C}$
Output noise voltage	V_N	$f = 10\text{Hz}$ to 100kHz , $T_a = 25^\circ\text{C}$	-	76	-	$\mu\text{V}/V_o$
Ripple rejection	RR	$f = 120\text{Hz}$, $V_i = 15\text{V}$ to 25V	53	64	-	dB
Dropout voltage	V_o	$I_o = 1.0\text{A}$, $T_j = 25^\circ\text{C}$	-	2	-	V
Output resistance	R_o	$f = 1\text{kHz}$	-	18	-	$\text{m}\Omega$
Short circuit current	I_{sc}	$V_i = 35\text{V}$, $T_a = 25^\circ\text{C}$	-	230	-	mA
peak current	I_{pk}	$T_j = 25^\circ\text{C}$	-	2.2	-	A

7815 ELECTRICAL CHARACTERISTICS

 (Refer to test circuits, $0 < T_j < 125^\circ\text{C}$, $I_o = 500\text{mA}$, $V_i = 23\text{V}$, $C_i = 0.33\mu\text{F}$, $C_o = 0.1\mu\text{F}$, unless otherwise specified)

Characteristic	Symbol	Test Conditions	Min	Typ	Max	Units
Output voltage	V_o	$T_j = 25^\circ\text{C}$	14.4	15.0	15.6	V
		$5.0\text{mA} < I_o < 1.0\text{A}$, $P_D < 15\text{W}$ $V_i = 17.5\text{V}$ to 30V	14.25	15	15.75	V
Line regulation	ΔV_o	$T_j = 25^\circ\text{C}$, $V_i = 17.5\text{V}$ to 30V	-	11	300	mV
		$T_j = 25^\circ\text{C}$, $V_i = 20\text{V}$ to 26V	-	3	150	mV
Load regulation	ΔV_o	$T_j = 25^\circ\text{C}$, $I_o = 5.0\text{mA}$ to 1.5A	-	12	300	mV
		$T_j = 25^\circ\text{C}$, $I_o = 250\text{mA}$ to 750mA	-	5	150	mV
Quiescent current	I_q	$T_j = 25^\circ\text{C}$	-	5.2	8	mA
Quiescent current change	ΔI_q	$I_o = 5\text{mA}$ to 1.0A	-	-	0.5	mA
		$V_i = 18\text{V}$ to 30.5V	-	-	0.8	mA
Output voltage drift	$\Delta V_o / \Delta T$	$I_o = 5\text{mA}$	-	2.0	-	mV/ $^\circ\text{C}$
Output noise voltage	V_N	$f = 10\text{Hz}$ to 100kHz , $T_a = 25^\circ\text{C}$	-	90	-	$\mu\text{V}/V_o$
Ripple rejection	RR	$f = 120\text{Hz}$, $V_i = 18.5\text{V}$ to 28.5V	51	62	-	dB
Dropout voltage	V_o	$I_o = 1.0\text{A}$, $T_j = 25^\circ\text{C}$	-	2	-	V
Output resistance	R_o	$f = 1\text{kHz}$	-	19	-	$\text{m}\Omega$
Short circuit current	I_{sc}	$V_i = 35\text{V}$, $T_a = 25^\circ\text{C}$	-	230	-	mA
peak current	I_{pk}	$T_j = 25^\circ\text{C}$	-	2.2	-	A

7818 ELECTRICAL CHARACTERISTICS

 (Refer to test circuits, $0 < T_j < 125^\circ\text{C}$, $I_o = 500\text{mA}$, $V_i = 26\text{V}$, $C_i = 0.33\mu\text{F}$, $C_o = 0.1\mu\text{F}$, unless otherwise specified)

Characteristic	Symbol	Test Conditions	Min	Typ	Max	Units
Output voltage	V_o	$T_j = 25^\circ\text{C}$	17.3	18.0	18.7	V
		$5.0\text{mA} < I_o < 1.0\text{A}$, $P_D < 15\text{W}$ $V_i = 21$ to 33V	17.1	18.0	18.9	V
Line regulation	ΔV_o	$T_j = 25^\circ\text{C}$, $V_i = 21$ to 33V	-	-	360	mV
		$T_j = 25^\circ\text{C}$, $V_i = 24\text{V}$ to 30V	-	-	180	mV
Load regulation	ΔV_o	$T_j = 25^\circ\text{C}$, $I_o = 5.0\text{mA}$ to 1.5A	-	-	360	mV
		$T_j = 25^\circ\text{C}$, $I_o = 250\text{mA}$ to 750mA	-	-	180	mV
Quiescent current	I_q	$T_j = 25^\circ\text{C}$	-	5.2	8	mA
Quiescent current change	ΔI_q	$I_o = 5\text{mA}$ to 1.0A	-	-	0.5	mA
		$V_i = 21\text{V}$ to 33V	-	-	1	mA
Output voltage drift	$\Delta V_o / \Delta T$	$I_o = 5\text{mA}$	-	2.3	-	mV/ $^\circ\text{C}$
Output noise voltage	V_N	$f = 10\text{Hz}$ to 100kHz , $T_a = 25^\circ\text{C}$	-	110	-	$\mu\text{V}/V_o$
Ripple rejection	RR	$f = 120\text{Hz}$, $V_i = 22\text{V}$ to 32V	51	57	-	dB
Dropout voltage	V_o	$I_o = 1.0\text{A}$, $T_j = 25^\circ\text{C}$	-	2	-	V
Output resistance	R_o	$f = 1\text{kHz}$	-	22	-	$\text{m}\Omega$
Short circuit current	I_{sc}	$V_i = 35\text{V}$, $T_a = 25^\circ\text{C}$	-	230	-	mA
peak current	I_{pk}	$T_j = 25^\circ\text{C}$	-	2.2	-	A

7824 ELECTRICAL CHARACTERISTICS

 (Refer to test circuits, $0 < T_j < 125^\circ\text{C}$, $I_o = 500\text{mA}$, $V_i = 33\text{V}$, $C_i = 0.33\mu\text{F}$, $C_o = 0.1\mu\text{F}$, unless otherwise specified)

Characteristic	Symbol	Test Conditions	Min	Typ	Max	Units
Output voltage	V_o	$T_j = 25^\circ\text{C}$	23	24	25	V
		$5.0\text{mA} < I_o < 1.0\text{A}$, $P_D < 15\text{W}$ $V_i = 27\text{V}$ to 38V	22.8	24	25.2	V
Line regulation	ΔV_o	$T_j = 25^\circ\text{C}$, $V_i = 27\text{V}$ to 38V	-	-	480	mV
		$T_j = 25^\circ\text{C}$, $V_i = 30\text{V}$ to 36V	-	-	240	mV
Load regulation	ΔV_o	$T_j = 25^\circ\text{C}$, $I_o = 5.0\text{mA}$ to 1.5A	-	-	480	mV
		$T_j = 25^\circ\text{C}$, $I_o = 250\text{mA}$ to 750mA	-	-	240	mV
Quiescent current	I_q	$T_j = 25^\circ\text{C}$	-	5.2	8	mA
Quiescent current change	ΔI_q	$I_o = 5\text{mA}$ to 1.0A	-	-	0.5	mA
		$V_i = 27\text{V}$ to 38V	-	-	1	mA
Output voltage drift	$\Delta V_o / \Delta T$	$I_o = 5\text{mA}$	-	3.0	-	mV/ $^\circ\text{C}$
Output noise voltage	V_N	$f = 10\text{Hz}$ to 100kHz , $T_a = 25^\circ\text{C}$	-	170	-	$\mu\text{V}/V_o$
Ripple rejection	RR	$f = 120\text{Hz}$, $V_i = 28\text{V}$ to 38V	50	54	-	dB
Dropout voltage	V_o	$I_o = 1.0\text{A}$, $T_j = 25^\circ\text{C}$	-	2	-	V
Output resistance	R_o	$f = 1\text{kHz}$	-	28	-	$\text{m}\Omega$
Short circuit current	I_{sc}	$V_i = 35\text{V}$, $T_a = 25^\circ\text{C}$	-	230	-	mA
peak current	I_{pk}	$T_j = 25^\circ\text{C}$	-	2.2	-	A

TEST CIRCUITS

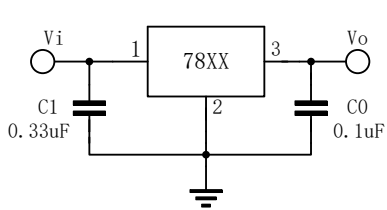

FIG.1 DC PARAMETERS

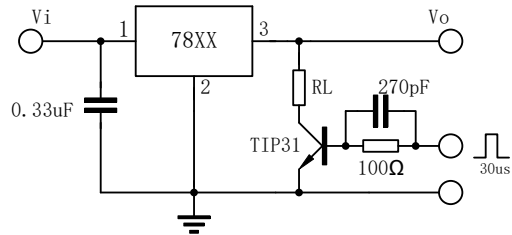

FIG.2 LOAD REGULATION

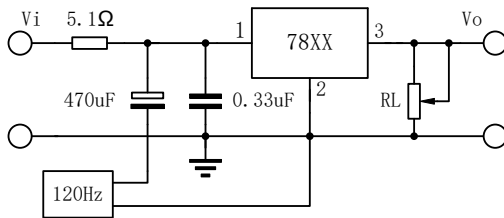

FIG.3 RIPPLE REJECTION

APPLICATION CIRCUITS

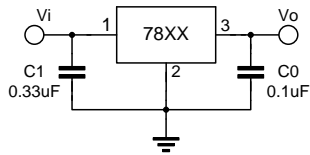

Fig.4 Fixed output regulator

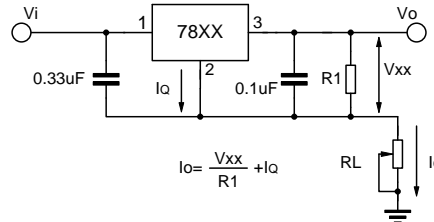

Fig.5 Constant current regulator

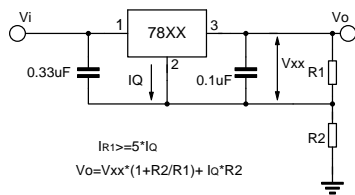

Fig.6 Circuit for increasing Regulator output voltage

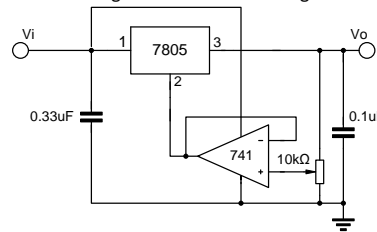
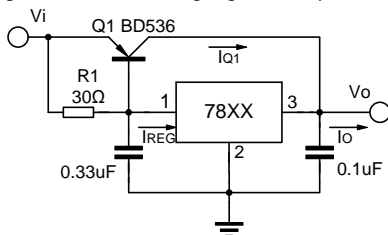

Fig.7 Adjustable output



$$I_o = I_{REG} \cdot (I_{REG} - V_{BEQ1}/R_1)$$

$$R_1 = V_{BEQ1}/I_{REG} - I_{Q1} \cdot Q_1$$

Fig.8 High current with voltage regulator

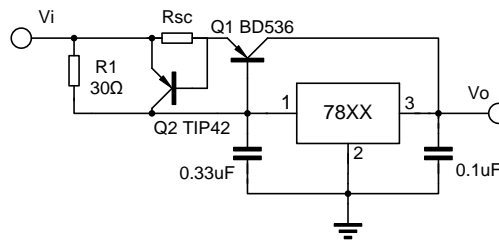

$$R_{sc} = V_{BEQ2}/I_{sc}$$

Fig.9 High output current short circuit protection

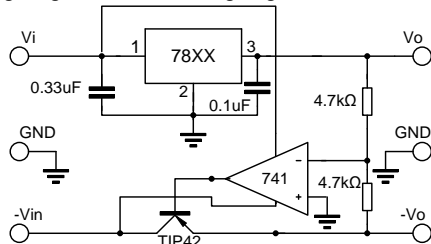

Fig.10 Tracking voltage regulator

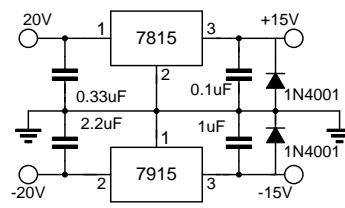

Fig.11 Split power supply ($\pm 15V, 1A$)

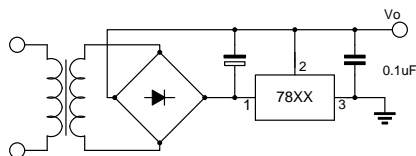

Fig.12 Negative output voltage circuit

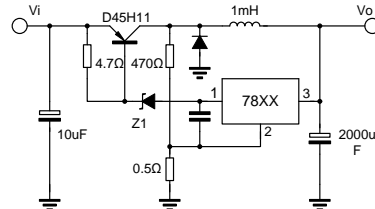

Fig.13 switching regulator

TYPICAL PERFORMANCE CHARACTERISTICS

Fig.14 Quiescent current

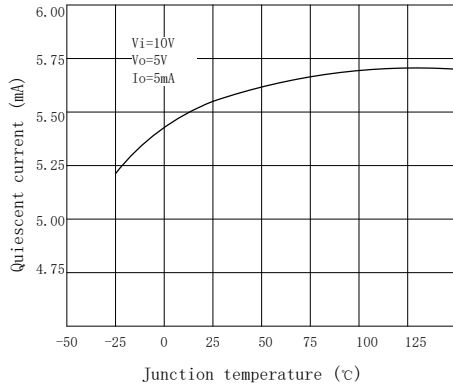

Fig.15 Output voltage

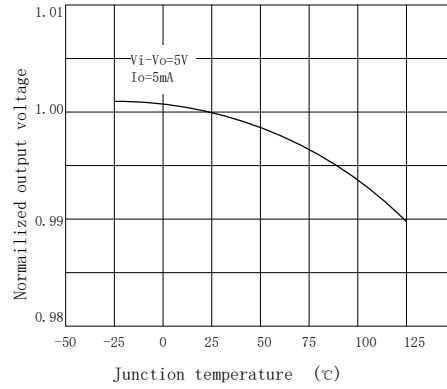

Fig.16 Peak output current

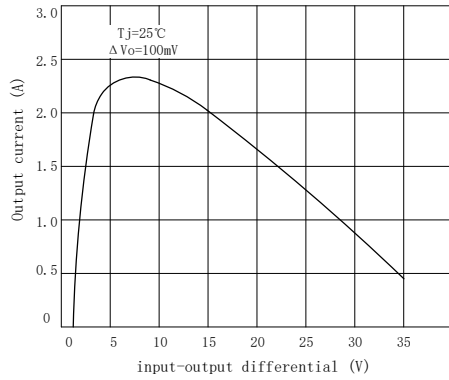
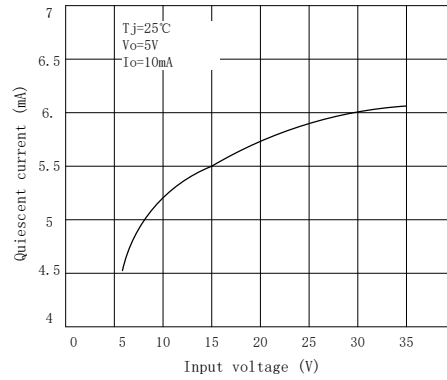

Fig.17 Quiescent current



X-ON Electronics

Largest Supplier of Electrical and Electronic Components

Click to view similar products for [Linear Voltage Regulators](#) category:

Click to view products by [Tokmas](#) manufacturer:

Other Similar products are found below :

[LV5684PVD-XH](#) [MCDTSA6-2R](#) [L7815ACV-DG](#) [LV56801P-E](#) [UA7805CKC](#) [714954EB](#) [ZMR500QFTA](#) [BA033LBSG2-TR](#)
[NCV78M05ABDTRKG](#) [LV5680P-E](#) [L79M05T-E](#) [L78LR05D-MA-E](#) [NCV317MBTG](#) [NTE7227](#) [MP2018GZD-33-P](#) [MP2018GZD-5-P](#)
[LV5680NPVC-XH](#) [ZTS6538SE](#) [UA78L09CLP](#) [UA78L09CLPR](#) [CAT6221-PPTD-GT3](#) [MC78M09CDTRK](#) [NCV51190MNTAG](#)
[BL1118CS8TR1833](#) [BL8077CKETR33](#) [BL9153-33CC3TR](#) [BL9161G-28BADRN](#) [BRCO7530MMC](#) [CJ7815B-TFN-ARG](#) [LM317C](#)
[GM7333K](#) [GM7350K](#) [XC6206P332MR](#) [HT7533](#) [LM7912S/TR](#) [LT1764S/TR](#) [LM7805T](#) [LM338T](#) [LM1117IMP-3.3/TR](#) [HT1117AM-3.3](#)
[HT7550S](#) [AMS1117-3.3](#) [HT7150S](#) [78L12](#) [HT7550](#) [HT7533-1](#) [HXY6206I-2.5](#) [HT7133](#) [HT7533S](#) [662K](#)