

Main features

Symbol	Value	Unit
$I_{T(RMS)}$	16	A
V_{DRM}/V_{RRM}	800	V
$I_{GT} (Q1)$	35	mA

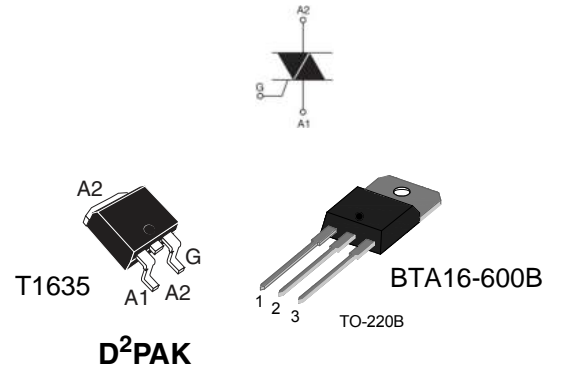

1 Characteristics

Table 1. Absolute maximum ratings

Symbol	Parameter			Value	Unit
$I_{T(RMS)}$	RMS on-state current (full sine wave)	D ² PAK	$T_c = 130^\circ\text{C}$	16	A
I_{TSM}	Non repetitive surge peak on-state current (full cycle sine wave, T_j initial = 25°C)	F = 60 Hz	t = 16.7 ms	170	A
		F = 50 Hz	t = 20 ms	160	
I2t	I2t Value for fusing	tp = 10 ms		100	A ² S
di/dt	Critical rate of rise of on-state current $I_G = 2 \times I_{GT}$, tr ≤ 100 ns	F = 120 Hz	$T_j = 150^\circ\text{C}$	50	A/μs
V_{DSM}/V_{RSM}	Non repetitive surge peak off state voltage		$T_j = 25^\circ\text{C}$	800	V
I_{GM}	Peak gate current	tp = 20 μs	$T_j = 150^\circ\text{C}$	4	A
$P_{G(AV)}$	Average gate power dissipation		$T_j = 150^\circ\text{C}$	1	W
T_{stg} T_j	Storage junction temperature range Operating junction temperature range			-40 to +150 -40 to +150	°C

Table 2. Electrical characteristics ($T_j = 25^\circ\text{C}$, unless otherwise specified)

Symbol	Test conditions	Quadrant		Value	Unit
$I_{GT}^{(1)}$	$V_D = 12\text{ V}$, $R_L = 33\ \Omega$	II - III	MAX	35	mA
V_{GT}		II - III	MAX	1.3	V
V_{GD}	$V_D = V_{DRM}$, $R_L = 3.3\ \text{k}\Omega$	II - III	MIN	0.15	V
$I_H^{(2)}$	$I_T = 100\ \text{mA}$		MAX	35	mA
I_L	$I_G = 1.2 \times I_{GT}$	I - III	MAX	50	mA
		II		80	
dV/dt ⁽²⁾	$V_D = 67\% V_{DRM}$, gate open, $T_j = 150^\circ\text{C}$		MIN	300	V/μs
(di/dt) _c ⁽²⁾	Without snubber, $T_j = 150^\circ\text{C}$		MIN	7.1	A/ms

1. minimum I_{GT} is guaranteed at 5% of I_{GT} max
2. for both polarities of A2 referenced to A1

Table 3. Static electrical characteristics

Symbol	Test conditions			Value	Unit
$V_{TM}^{(1)}$	$I_{TM} = 22.5\text{ A}$, $t_p = 380\ \mu\text{s}$	$T_j = 25^\circ\text{ C}$	MAX	1.5	V
$V_{TO}^{(1)}$		$T_j = 150^\circ\text{ C}$	MAX	0.80	V
$R_D^{(1)}$		$T_j = 150^\circ\text{ C}$	MAX	23	m Ω
I_{DRM} I_{RRM}	$V_{DRM} = V_{RRM}$ $V_D/V_R = 400\text{ V (at peak mains voltage)}$	$T_j = 25^\circ\text{ C}$	MAX	5	μA
		$T_j = 150^\circ\text{ C}$		6.4	mA
		$T_j = 150^\circ\text{ C}$		4.2	

1. for both polarities of A2 referenced to A1

Table 4. Thermal resistance

Symbol	Parameter		Value	Unit
$R_{th(j-c)}$	Junction to case (AC)	D ² PAK	1.2	$^\circ\text{C/W}$
$R_{th(j-a)}$	Junction to ambient		45	

Figure 1. Maximum power dissipation vs RMS on-state current (full cycle)

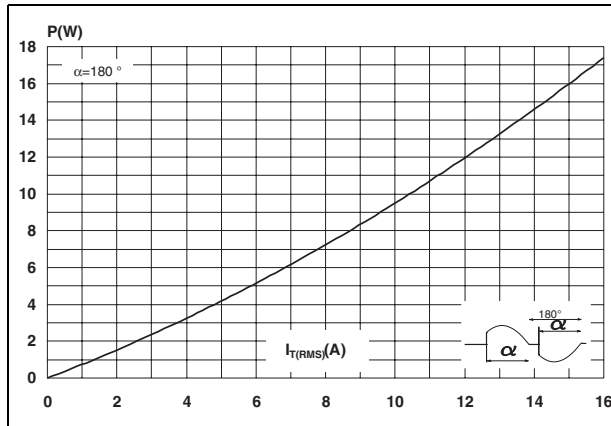

Figure 2. RMS on-state current vs case temperature (full cycle)

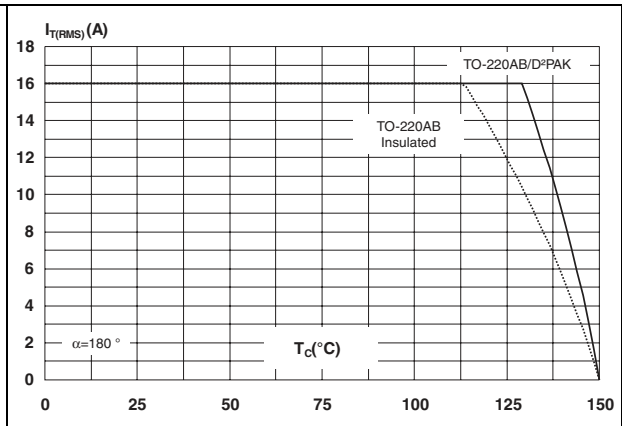

Figure 3. RMS on-state current vs ambient temperature, PCB FR4, $e_{CU} = 35 \mu m$

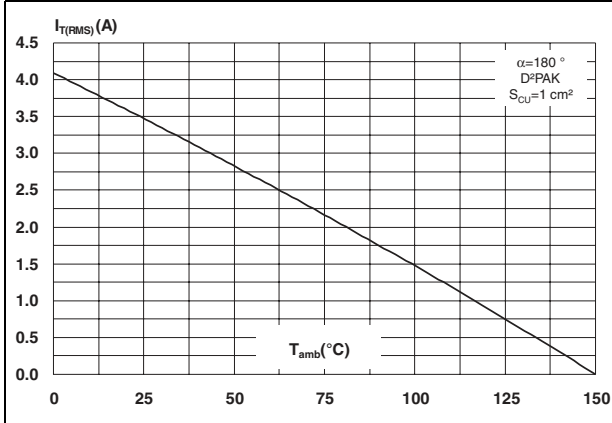

Figure 4. Relative variation of thermal impedance vs pulse duration

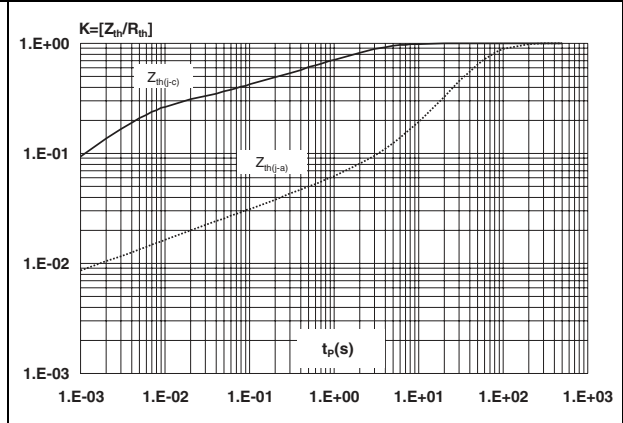

Figure 5. Relative variation of gate trigger current, holding current and latching current vs junction temperature (typical values)

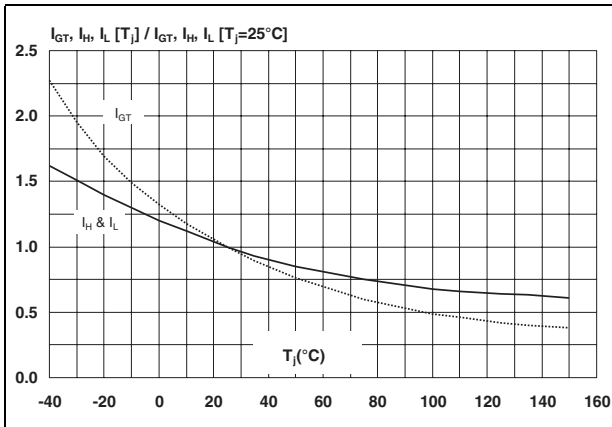

Figure 6. Surge peak on-state current vs number of cycles

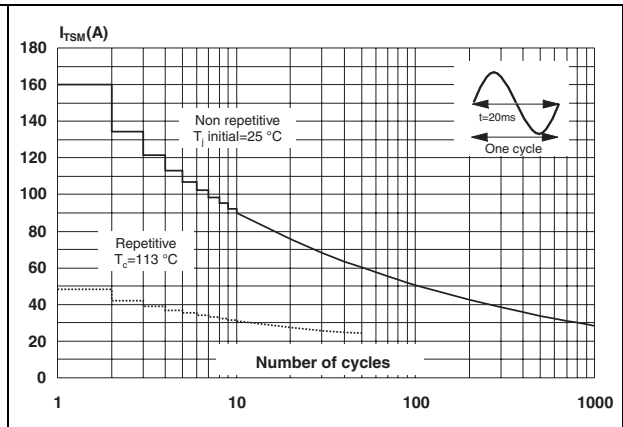

Figure 7. Non repetitive surge peak on-state current (sinusoidal pulse width $t_p < 10 ms$) and corresponding value of I^2t

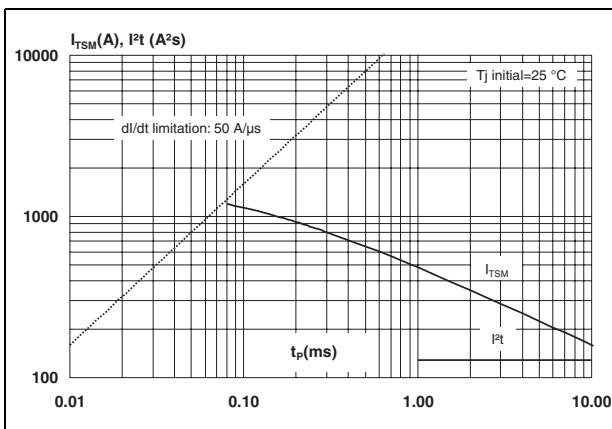

Figure 8. On-state characteristics (maximum values)

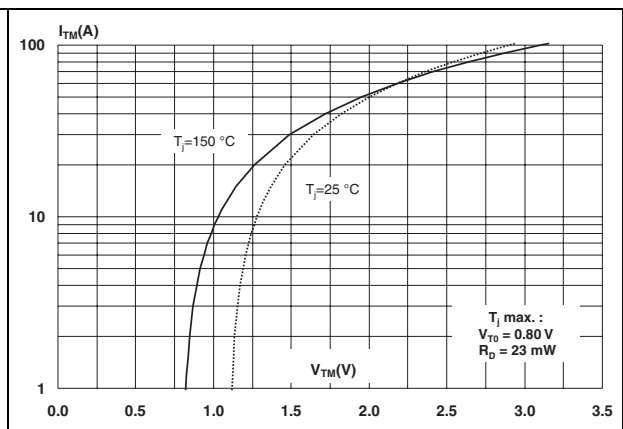

Figure 9. Relative variation of critical rate of decrease of main current $(di/dt)_c$ versus junction temperature

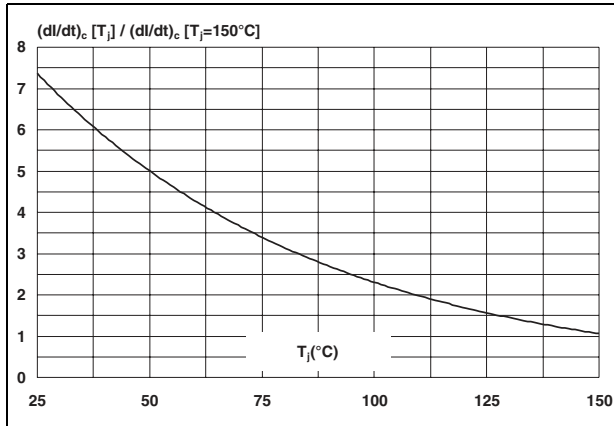

Figure 10. Relative variation of critical rate of decrease of main current $(di/dt)_c$ versus reapplied dV/dt (typical values)

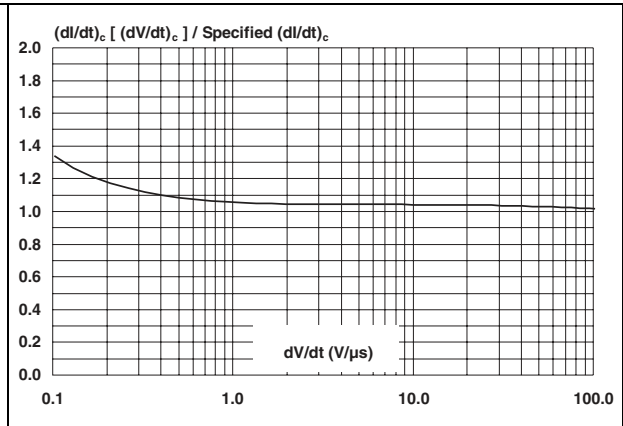

Figure 11. Variation of thermal resistance, junction to ambient versus copper surface under tab (PCB FR4, e_{Cu} 35 μm)

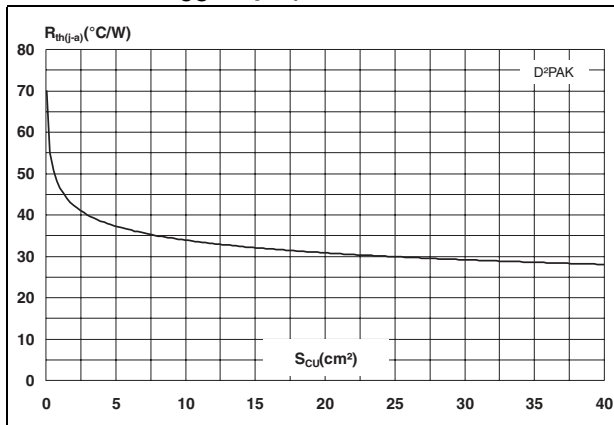

Figure 12. Leakage current versus junction temperature for different values of blocking voltage (typical values)

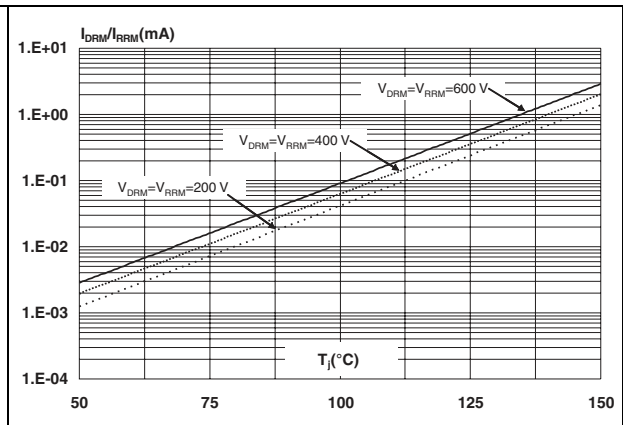

Figure 13. Acceptable repetitive peak off-state voltage versus case-ambient thermal resistance

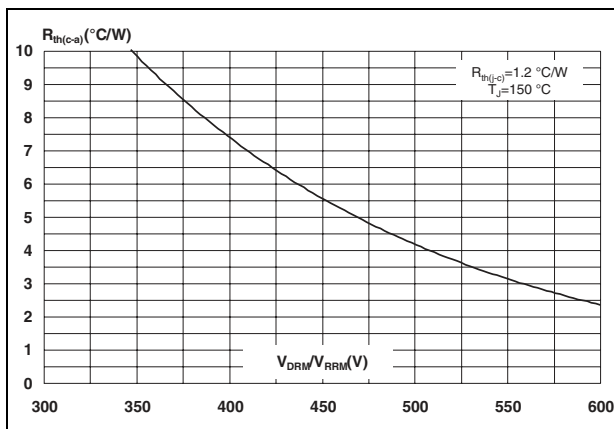
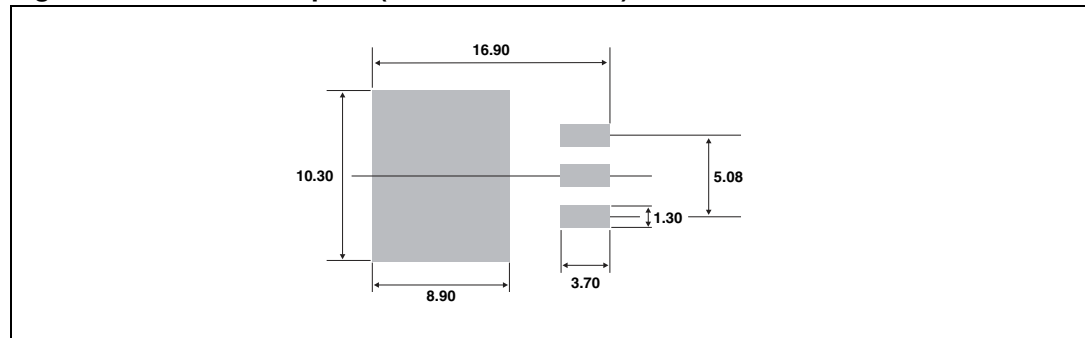

Table 5. D²PAK Mechanical data

REF.	DIMENSIONS			
	Millimeters		Inches	
	Min.	Max.	Min.	Max.
A	4.40	4.60	0.173	0.181
A1	2.49	2.69	0.098	0.106
A2	0.03	0.23	0.001	0.009
B	0.70	0.93	0.027	0.037
B2	1.14	1.70	0.045	0.067
C	0.45	0.60	0.017	0.024
C2	1.23	1.36	0.048	0.054
D	8.95	9.35	0.352	0.368
E	10.00	10.40	0.393	0.409
G	4.88	5.28	0.192	0.208
L	15.00	15.85	0.590	0.624
L2	1.27	1.40	0.050	0.055
L3	1.40	1.75	0.055	0.069
M	2.40	3.20	0.094	0.126
R	0.40 typ.		0.016 typ.	
V2	0°	8°	0°	8°

Figure 14. D²PAK Footprint (dimensions in mm)





PACKAGE MECHANICAL DATA

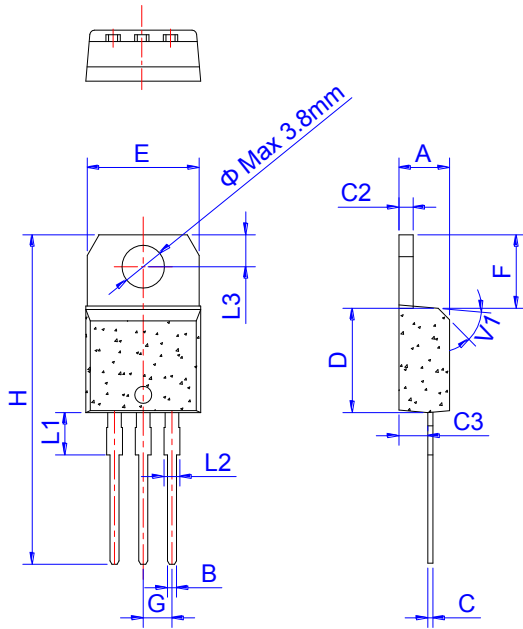

Ref.	Dimensions					
	Millimeters			Inches		
	Min.	Typ.	Max.	Min.	Typ.	Max.
A	4.40		4.60	0.173		0.181
B	0.61		0.88	0.024		0.035
C	0.46		0.70	0.018		0.028
C2	1.21		1.32	0.048		0.052
C3	2.40		2.72	0.094		0.107
D	8.60		9.70	0.339		0.382
E	9.80		10.4	0.386		0.409
F	6.55		6.95	0.258		0.274
G		2.54			0.1	
H	28.0		29.8	1.102		1.173
L1		3.75			0.148	
L2	1.14		1.70	0.045		0.067
L3	2.65		2.95	0.104		0.116
V1		45°			45°	

X-ON Electronics

Largest Supplier of Electrical and Electronic Components

Click to view similar products for [Triacs](#) category:

Click to view products by [Tokmas](#) manufacturer:

Other Similar products are found below :

[BT137-600-0Q](#) [OT415Q](#) [2N6075A](#) [NTE5688](#) [BTA2008W-800D,135](#) [D31410](#) [ACS102-5T1](#) [ACS102-5TA](#) [MAC97A4G](#) [Z0107MAG](#)
[Z0107MARL1G](#) [Z0109MARLRPG](#) [MAC97A8-TA](#) [BT131W-800](#) [BT138S-800E](#) [BT137S-800E](#) [BT136S-600D](#) [BTA08-600TWRG](#)
[X0405MF-252](#) [MAC97A8-23-3L](#) [MCR100-8-23-3L](#) [BTA24-800B](#) [BT151-600R](#) [BT131](#) [BTA41-1200B](#) [MCR16](#) [MCR100-8](#) [MCR16](#)
[BT131-800D](#) [BT134-800E](#) [BT138-800E](#) [MCR100-8](#) [BTA12-800BWRG\(UMW\)](#) [BTA24-600BWRG\(UMW\)](#) [BTA24-800BWRG\(UMW\)](#)
[BTA12-600BWRG\(UMW\)](#) [BTA16-600CRG\(UMW\)](#) [BTA12-600CRG\(UMW\)](#) [BS61089B-8](#) [BT134W-600E](#) [BT134-600E](#) [JR0405S3](#)
[BCR12PM](#) [MAC97A6](#) [BTA24-800CRG\(UMW\)](#) [BTA16-600BRG\(UMW\)](#) [BTA16-800BWRG\(UMW\)](#) [Z0109-NN](#) [BTA41](#) [MCR100-8U](#)