

MKP 型金属化聚丙烯膜抗干扰电容器

Metallized Polypropylene Film Capacitor For Electromagnetic Interference Suppression Type MKP (X2 class)

■ 特点 Features

- 体积小、阻燃塑壳封装、阻燃环氧灌注 small size; encapsulated in flame retardant plastic case; Its components are sealed with epoxy resin.
- 能承受过压冲击 Withstand over voltage stressing
- 有自愈性 With Self-healing property
- 用于电源网络连接，抗电磁干扰 Usage of connection to the supply mains, electromagnetic interferences suppression
- 用于电火花抑制电路 Applied to sparkle-suppression circuits
- 用于功率开关电源 Applied to the mains of power switch

■技术规范 Technical Specifications





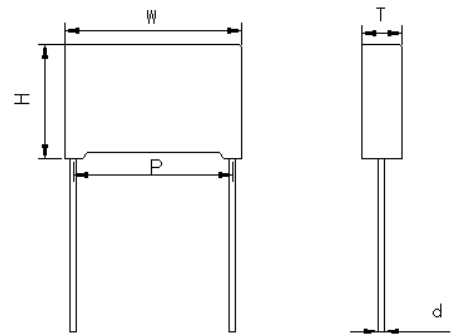

- 引用标准 Reference standard GB/T 14472 (IEC 60384-14)
- 额定值和特性 Ratings and Characteristics
- 气候类别 Climate category: 40/100/56
- 额定电压 Rated voltage: 275VAC~305VAC

- 电容量范围 Capacitance range: $0.01 \sim 1.0 \mu\text{F}$
- 电容量偏差 Cap. tolerance: $\pm 10\%$ (K)、 $\pm 20\%$ (M)
- 损耗角正切 Dissipation factor: $C < 0.47 \mu\text{F}$, $\text{tg } \delta \leq 12 \times 10^{-4}$ (20°C, 10KHz)
 $C \geq 0.47 \mu\text{F}$, $\text{tg } \delta \leq 15 \times 10^{-4}$ (20°C, 10KHz)
- 耐电压 voltage proof: $4.3U_n$ (DC) (2S)
- 绝缘电阻 I. R.: 测试电压为 500V, $C \leq 0.33 \mu\text{F}$, $R \geq 30000\text{M}\Omega$; $C > 0.33 \mu\text{F}$, $R \geq 10000\text{S}$

■安全认证 safety Approvals

本产品已通过 GB/T 14472 (IEC 60384-14) EN 132400、UL1283 等标准的试验，取得欧洲、美国及国内的认证证书。The product has been tested with the edition standards, Such as GB/T 14472 (IEC 60384-14) EN 132400, UL1283 etc. and acquired correlative safety certificates from Europe, America and the domestic .

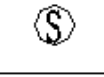

| | | | |
|---|--|--------|---|
| ● |  | VDE | DIN EN 60384-14, 275VAC, 305VAC, 0.01 μ F ~ 1.0 μ F Certificate No. :40048412 |
| ● |  | CQC | GB/T 14472, 275VAC, 0.01 μ F ~ 1.0 μ F Certificate No. :CQC 03001004439 |
| ● |  | UL/CUL | UL60384, 250VAC, 275VAC, 305VAC, 0.01 μ F ~ 1.0 μ F Certificate No. : E214748 |
| ● |  | NEMKO | IEC 60384-14, EN 132400, 275VAC, 0.01 μ F ~ 1.0 μ F Certificate No. :P02100305 |
| ● |  | FIMKO | IEC 60384-14, EN, 132400, 275VAC, 0.01 μ F ~ 1.0 μ F Certificate No. :221392 |
| ● |  | SEMKO | IEC 60384-14, EN, 132400, 275VAC, 0.01 μ F ~ 1.0 μ F Certificate No. :0204005/01 |
| ● |  | DEMKO | IEC 60384-14, EN 132400, 275VAC, 0.01 μ F ~ 1.0 μ F Certificate No. :311257-01 |
| ● |  | SWISS | IEC 60384-14, EN 132400, 275VAC, 0.01 μ F ~ 1.0 μ F Certificate No. :2.0087 |

■外形尺寸 Dimensions(mm)

| 电容量 (μ F) | 额定电压 (V) | 外形尺寸 Dimensions (mm) | | | | |
|----------------|-----------|----------------------|-------------|-------------|-----------|-----|
| | | W \pm 0.5 | H \pm 0.5 | T \pm 0.5 | p \pm 1 | d |
| 0.01 | 275 (305) | 13 | 11 | 5 | 10 | 0.6 |
| 0.015 | | 13 | 11 | 5 | 10 | 0.6 |
| 0.022 | | 13 | 11 | 5 | 10 | 0.6 |
| 0.033 | | 13 | 11 | 5 | 10 | 0.6 |
| 0.047 | | 13 | 11 | 5 | 10 | 0.6 |
| 0.068 | | 13 | 11 | 5 | 10 | 0.6 |
| 0.1 | | 13 | 12 | 6 | 10 | 0.6 |
| 0.15 | | 18 | 11 | 5 | 15 | 0.8 |
| 0.22 | | 18 | 14.5 | 8.5 | 15 | 0.8 |
| 0.33 | | 18 | 14.5 | 8.5 | 15 | 0.8 |
| 0.47 | | 18 | 16 | 10 | 15 | 0.8 |
| 0.68 | | 26.5 | 17 | 8.5 | 22.5 | 0.8 |
| 1.0 | | 26.5 | 19 | 10 | 22.5 | 0.8 |

注：表中以外的规格和尺寸，可以商谈。

Note: Other specifications and dimensions out of the table are discussible .

X-ON Electronics

Largest Supplier of Electrical and Electronic Components

Click to view similar products for [Film Capacitors](#) category:

Click to view products by [Tongfeng](#) manufacturer:

Other Similar products are found below :

[F339X134748MIP2T0](#) [F450KG153J250ALH0J](#) [750-1018](#) [FKP1-1500160010P15](#) [FKP1R031007D00JYSD](#) [FKP1R031507E00JYSD](#)
[FKP1U024707E00KYSD](#) [82DC4100CK60J](#) [82EC1100DQ50K](#) [PFR5101J100J11L16.5TA18](#) [PME261JB5220KR19T0](#) [A451GK223M040A](#)
[A561ED221M450A](#) [QXJ2E474KTPT](#) [QXL2B333KTPT](#) [R49AN347000A1K](#) [EEC2G505HQA406](#) [B25668A6676A375](#) [B25673A4282E140](#)
[BFC233868148](#) [BFC2370GC222](#) [C3B2AD44400B20K](#) [C4ASWBU3220A3EK](#) [CB027C0473J--](#) [CB177I0184J--](#) [CB182K0184J--](#) [23PW210](#)
[950CQW5H-F](#) [SBDC3470AA10J](#) [SCD105K122A3-22](#) [2N3155](#) [A571EH331M450A](#) [FKP1-2202KV5P15](#) [FKS3-680040010P10](#)
[QXL2E473KTPT](#) [445450-1](#) [B25669A3996J375](#) [46KI322000M1M](#) [46KR415050M1K](#) [4BSNBX4100ZBFJ](#) [MKP383510063JKP2T0](#)
[MKPY2-.02230020P15](#) [MKT 1813-368-015](#) [4055292001](#) [46KN410000N1K](#) [EEC2E106HQA405](#) [EEC2G205HQA402](#) [EEC2G805HQA415](#)
[P409CP224M250AH470](#) [82EC2150DQ50K](#)