

## MKP 型金属化聚丙烯膜抗干扰电容器

### Metallized Polypropylene Film Capacitor For Electromagnetic Interference Suppression Type MKP (X2 class)

#### ■ 特点 Features

- 体积小、阻燃塑壳封装、阻燃环氧灌注 small size; encapsulated in flame retardant plastic case; Its components are sealed with epoxy resin.
- 能承受过压冲击 Withstand over voltage stressing
- 有自愈性 With Self-healing property
- 用于电源网络连接，抗电磁干扰 Usage of connection to the supply mains, electromagnetic interferences suppression
- 用于电火花抑制电路 Applied to spark-suppression circuits
- 用于功率开关电源 Applied to the mains of power switch





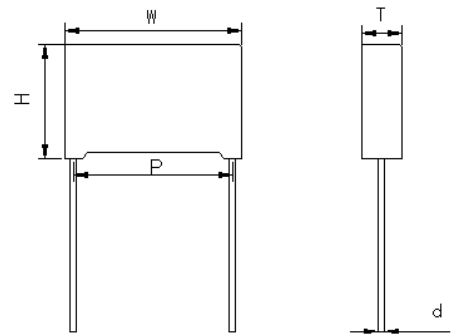

#### ■技术规范 Technical Specifications

- 引用标准 Reference standard GB/T 14472 (IEC 60384-14)
- 额定值和特性 Ratings and Characteristics
- 气候类别 Climate category: 40/100/56
- 额定电压 Rated voltage: 275VAC~305VAC
  
- 电容量范围 Capacitance range:  $0.01 \sim 1.0 \mu\text{F}$
- 电容量偏差 Cap. tolerance:  $\pm 10\%$  (K)、 $\pm 20\%$  (M)
- 损耗角正切 Dissipation factor:  $C < 0.47 \mu\text{F}$ ,  $\text{tg } \delta \leq 12 \times 10^{-4}$  (20°C, 10KHz)  
 $C \geq 0.47 \mu\text{F}$ ,  $\text{tg } \delta \leq 15 \times 10^{-4}$  (20°C, 10KHz)
- 耐电压 voltage proof:  $4.3U_n$  (DC) (2S)
- 绝缘电阻 I. R.: 测试电压为 500V,  $C \leq 0.33 \mu\text{F}$ ,  $R \geq 30000\text{M}\Omega$ ;  $C > 0.33 \mu\text{F}$ ,  $R \geq 10000\text{S}$

#### ■安全认证 safety Approvals

本产品已通过 GB/T 14472 (IEC 60384-14) EN 132400、UL1283 等标准的试验，取得欧洲、美国及国内的认证证书。The product has been tested with the edition standards, Such as GB/T 14472 (IEC 60384-14) EN 132400, UL1283 etc. and acquired correlative safety certificates from Europe, America and the domestic .

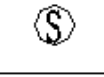

●		VDE	DIN EN 60384-14, 275VAC, 305VAC, 0.01 $\mu$ F ~ 1.0 $\mu$ F Certificate No. :40048412
●		CQC	GB/T 14472, 275VAC, 0.01 $\mu$ F ~ 1.0 $\mu$ F Certificate No. :CQC 03001004439
●		UL/CUL	UL60384, 250VAC, 275VAC, 305VAC, 0.01 $\mu$ F ~ 1.0 $\mu$ F Certificate No. : E214748
●		NEMKO	IEC 60384-14, EN 132400, 275VAC, 0.01 $\mu$ F ~ 1.0 $\mu$ F Certificate No. :P02100305
●		FIMKO	IEC 60384-14, EN, 132400, 275VAC, 0.01 $\mu$ F ~ 1.0 $\mu$ F Certificate No. :221392
●		SEMKO	IEC 60384-14, EN, 132400, 275VAC, 0.01 $\mu$ F ~ 1.0 $\mu$ F Certificate No. :0204005/01
●		DEMKO	IEC 60384-14, EN 132400, 275VAC, 0.01 $\mu$ F ~ 1.0 $\mu$ F Certificate No. :311257-01
●		SWISS	IEC 60384-14, EN 132400, 275VAC, 0.01 $\mu$ F ~ 1.0 $\mu$ F Certificate No. :2.0087

■外形尺寸 Dimensions(mm)

电容量 ( $\mu$ F)	额定电压 (V)	外形尺寸 Dimensions (mm)				
		W $\pm$ 0.5	H $\pm$ 0.5	T $\pm$ 0.5	p $\pm$ 1	d
0.01	275 (305)	13	11	5	10	0.6
0.015		13	11	5	10	0.6
0.022		13	11	5	10	0.6
0.033		13	11	5	10	0.6
0.047		13	11	5	10	0.6
0.068		13	11	5	10	0.6
0.1		13	12	6	10	0.6
0.15		18	11	5	15	0.8
0.22		18	14.5	8.5	15	0.8
0.33		18	14.5	8.5	15	0.8
0.47		18	16	10	15	0.8
0.68		26.5	17	8.5	22.5	0.8
1.0		26.5	19	10	22.5	0.8

注：表中以外的规格和尺寸，可以商谈。

Note: Other specifications and dimensions out of the table are discussible .

## X-ON Electronics

Largest Supplier of Electrical and Electronic Components

*Click to view similar products for [Film Capacitors](#) category:*

*Click to view products by [Tongfeng](#) manufacturer:*

Other Similar products are found below :

[F339X134748MIP2T0](#) [F450KG153J250ALH0J](#) [750-1018](#) [FKP1-1500160010P15](#) [FKP1R031007D00JYSD](#) [FKP1R031507E00JYSD](#)  
[FKP1U024707E00KYSD](#) [82DC4100CK60J](#) [82EC1100DQ50K](#) [PFR5101J100J11L16.5TA18](#) [PME261JB5220KR19T0](#) [A451GK223M040A](#)  
[A561ED221M450A](#) [QXJ2E474KTPT](#) [QXL2B333KTPT](#) [R49AN347000A1K](#) [EEC2G505HQA406](#) [B25668A6676A375](#) [B25673A4282E140](#)  
[BFC233868148](#) [BFC2370GC222](#) [C3B2AD44400B20K](#) [C4ASWBU3220A3EK](#) [CB027C0473J--](#) [CB177I0184J--](#) [CB182K0184J--](#) [23PW210](#)  
[950CQW5H-F](#) [SBDC3470AA10J](#) [SCD105K122A3-22](#) [2N3155](#) [A571EH331M450A](#) [FKP1-2202KV5P15](#) [FKS3-680040010P10](#)  
[QXL2E473KTPT](#) [445450-1](#) [B25669A3996J375](#) [46KI322000M1M](#) [46KR415050M1K](#) [4BSNBX4100ZBFJ](#) [MKP383510063JKP2T0](#)  
[MKPY2-.02230020P15](#) [MKT 1813-368-015](#) [4055292001](#) [46KN410000N1K](#) [EEC2E106HQA405](#) [EEC2G205HQA402](#) [EEC2G805HQA415](#)  
[P409CP224M250AH470](#) [82EC2150DQ50K](#)