



深圳东裕光大电子有限公司
广州市东裕光电科技有限公司

产品规格书 SPECIFICATION

客户名称 CUSTOMER	
产品名称 PRODUCTION	红外线接收头 Infrared Receiver Module
产品型号 MODEL	DY-IRMA385-T5-W1-F1
版本号 VERSION NO	A1.0

地址(Add): 深圳市宝安区沙井街道后亭沙松路全至科技创新园叁号楼 5T

厂址(Add): 广东省广州市番禺区石基镇海涌路 3 号 10 号厂房 2 楼

电话(Tel): 020-39294688

传真(Fax): 020-39966833

邮箱(E-mail): zlx@dyled.cn

网址(Net): www.tonyuled.com



客户确认 CUSTOMER CONFIRMATION	审核 CHECKED BY	编制 PREPARED BY
	邓晓军	区家俊

产品描述 Descriptions

- DY-IRMA385-T5-W1-F1 内含高速高灵敏度 PIN 光电二极管和低功耗、高增益前置放大 IC，采用内屏蔽封装，在红外遥控系统中做接收器使用。

产品特性 Features

- 模块封装，内屏蔽；
- 工作电压：2.7-5.5V；
- 抗变频、电磁、光干扰强；
- 输出匹配 TTL、COMS 电平，低电平有效；
- 无铅；
- 符合 RoHS 要求；

产品应用 Applications

- DVD
- TV
- 机顶盒
- 风扇等

包装方式 Packing Quantity Specification

- 500PCS/袋(500PCS/1Bag)

一、外形图 Outline dimensions:

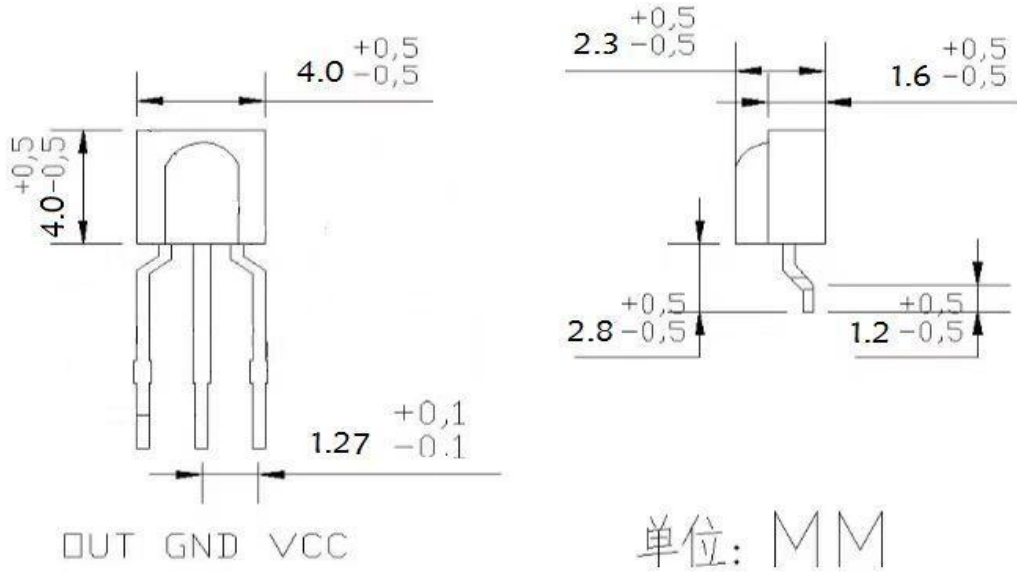

Notes: 1. All dimensions are in mm, tolerance is ± 0.2 unless otherwise noted.

二、应用电路

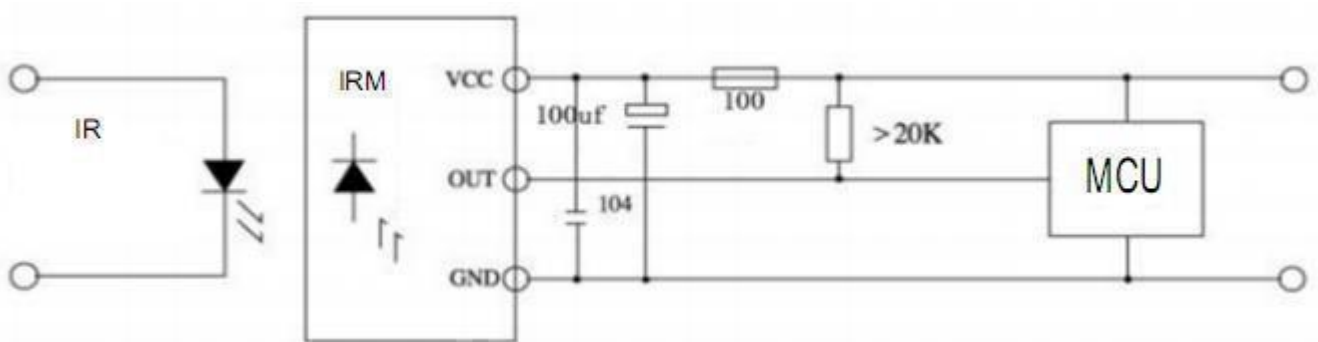

三、原理图

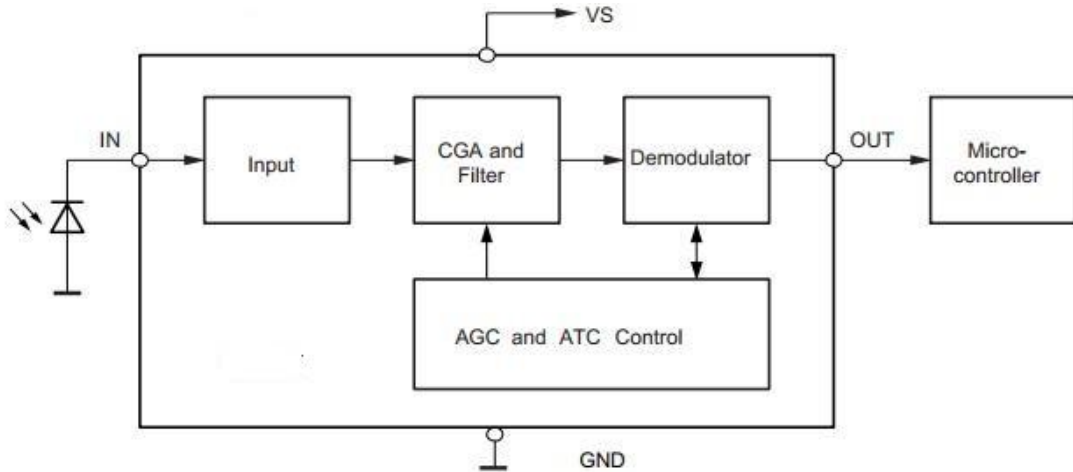

※备注：承认书之编号和型号可用于查询，客户如有需要，请提供相应的编号和型号。

Remark: P/N & Model in samples approval sheet can be used to inquire, please provide corresponding P/N & model if customer need.

四、光电参数 Electro-Optical Characteristics:

(环境温度 Ambient temperature: 25°C, 环境湿度 Humidity: RH60%)

参数	符号	测试条件	Min	Type	Max	单位
工作电流	Icc	VDD=5v	100	200	310	uA
接收距离	L	0°	10	12	-	M
		左 35°	5	6	-	
		右 35°	5	6	-	
载波频率	F0	37.9K				HZ
BPF 宽度	FBw		-	3.8	-	kHz
低电平输出	VoL	Isink=2.0mA	-	-	250	mV
高电平输出	VoH	Vcc=5V	Vcc-0.25	-	5	V
输出脉冲宽度	Tpwl	burst wave Vin=500μVp-p*	500	600	700	μS
	Tpwh	burst wave Vin=50mVp-p*	500	600	700	μS
最小脉冲宽度	Tburst	Vin=50mV p-p	300	-	-	us
最小间隔时间	Tburst gap	Vin=50mV p-p	350	-	-	us
编码停顿时间	Tpause	Vin=50mV p-p	45	-	-	ms

注(Notes): ※发射为 XHY5030-12U, 室内无阳光直射接收窗, 前上方 1M 置 40W 电子整流日光灯干绕, 灯光强度为 200±50Lux。

五、测试波形

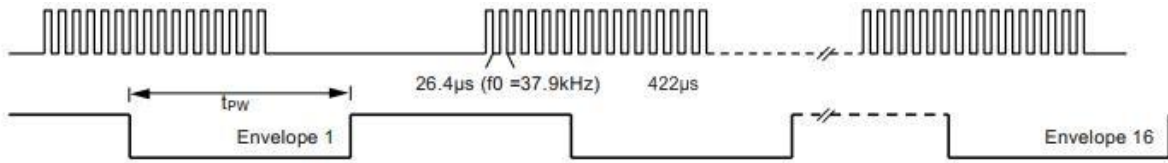

六、接收角度测试方式:

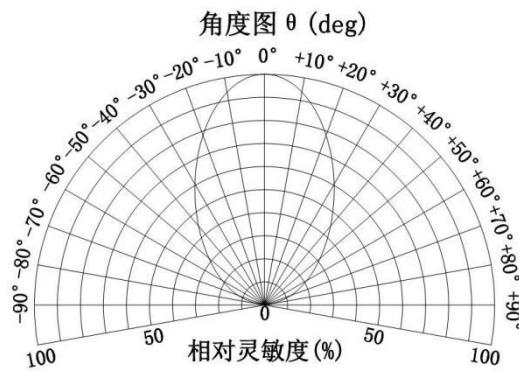
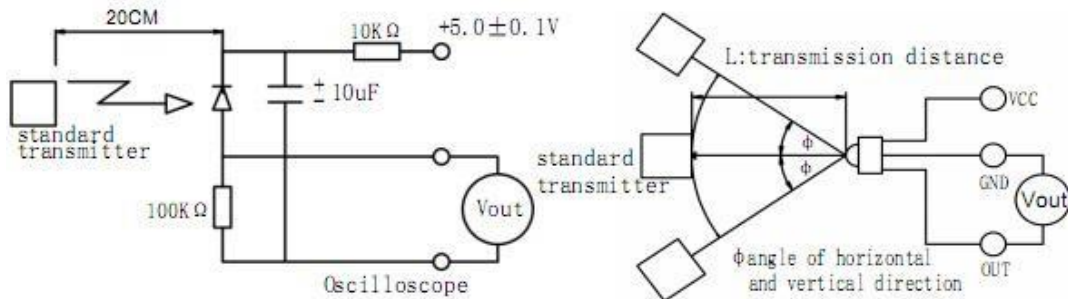

七、特性曲线图

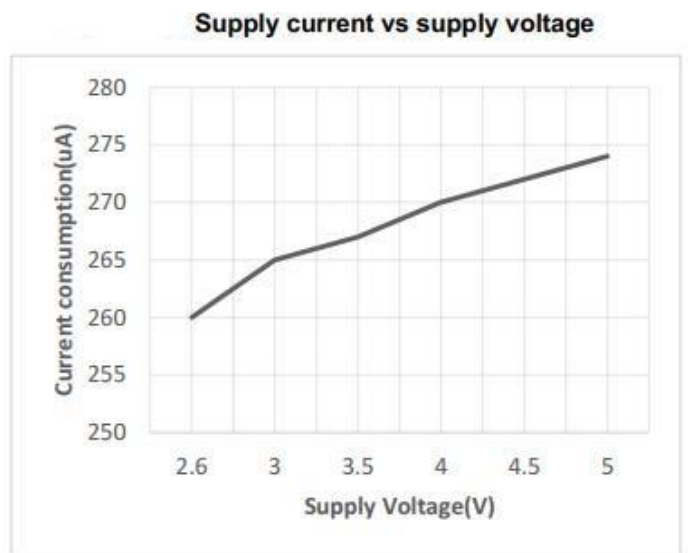
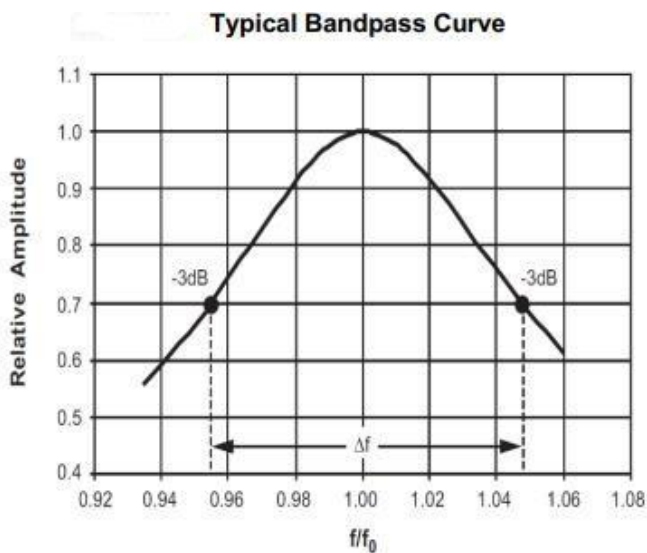

八、极限参数:

项目	符号	规格	单位
供应电压	Vcc	6.0	V
储存温度	Tstg	-40-125	°C
焊接温度	Tsol	260	°C

九、推荐使用条件:

项目	符号	Min	Typ	Max	单位
工作电压	Vcc	2.7	-	5.5	V
输入频率	FM		37.9		kHz
工作温度	Topr	-	25	-	°C

十、可靠性实验项目 Reliability Test Project:

描述 Description	项目 Item	测试标准 Test criterion	测试条件 Test condition	测试时间 Test time	数量 Qty.	失效数量 Fail Qty.
寿命测试 Life test	常温寿命测试 Life test (room temperature)	JIS7021:B4	Ta=25°C±5°C, IF=20mA	1000Hrs	22	0
环境测试 Ambience test	高温存储 High temperature store	JIS7021:B10 MIL-STD-202:210A MIL-STD-750:2031	Ta=85°C±5°C	1000Hrs	22	0
	低温存储 Low temperature store	JIS7021:B12	Ta= -35°C±5°C	1000Hrs	22	0
	高温高湿测试 High temperature/ humidity test	JIS7021:B11 MIL-STD-202:103D	Ta=85°C±5°C RH=85%	1000Hrs	22	0
	冷热冲击测试 Cold / Heat strike test	JIS7021:B4 MIL-STD-202:107D MIL-STD-750:1026	30min -10°C±5°C ←→ 100°C±5°C 5min 5min	50Cycles	22	0
	冷热循环测试 Cold and heat cycle test	JIS7021:A3 MIL-STD-202:107D MIL-STD-705:105E	5min 5min 5min -35°C~25°C~85°C~-35°C 30min 5min 30min 5min	50Cycles	22	0



十一、注意事项 Note:

1、引脚成形方法 LED bracket forming method

(1) 必需离胶体 2 毫米才能折弯支架。

The pin of LED can be bent where is at least 2mm out of LED colloid.

(2) 支架成形必须用夹具或由专业人员来完成。

Must use fixture to deform the LED bracket.

(3) 支架成形必须在焊接前完成。

Finishing the forming of LED bracket must be before soldering.

(4) 支架成形需保证引脚和间距与线路板上的一致。

Guarantee the gap between two pin of LED tallys with LED pads in PCB when forming.

2、烙铁焊接 Manual soldering

烙铁（最高 30W）尖端温度不超过 300℃；焊接时间不超过 3 秒；焊接位置至少离胶体 3 毫米。

The tip temperature of soldering iron don't exceed 300℃; soldering time don't exceed 3s and soldering position must be 3mm out of led colloid.

3、防静电措施 ESD countermeasure

静电及高压会对 LED 造成损坏，特别是芯片材质为 InGaN 的产品对静电防护要求更加严格，要求在使用和检验产品时戴防静电手腕带或防静电手套，焊接工具及设备外壳需可靠接地，焊接条件遵循此份规格书中的条件。

Static electricity and high volt can damage LED, The production whose Die material is InGaN must strictly required to prevent ESD, Must put on static glove and static fillet, Soldering tool and the cover of device must connect the ground, soldering condition follows the related stating of production specification manual.

4、过电流保护 Protecting countermeasure when over current

为避免由于电压的变化引起大电流冲击而造成产品损坏，需要加入保护电阻。

Need add the protecting resistor in circuit in order to avoid damaging led due to big current and voltage fluctuation.

5、LED 安装方法 LED installation method

(1) 注意各类器件外线的排列以防极性装错，器件不可与发热组件靠得太近，工作条件不要超过其规定的极限。

Pay attention to the LED polarity and avoid installation wrong. LED can't be close to euthermic component, work condition should tally with it's specification.

(2) 务必不要在引脚间距变形的情况下安装 LED。

Don't install the LED under the condition of the led pin deformation.

(3) 当装配 LED 进入 PCB 或装配孔时，LED 支架不能承受任何压力。

The LED bracket don't load any pressure when installing the LED into PCB or fitting hole.

(4) 在焊接温度回到正常以前，必须避免使 LED 受到任何的震动或外力。



Must avoid any strike and force on LED before the soldering temperature return to room temperature。

6、存储时间 Storage time

(1) 在温度 5℃~35℃，湿度 RH60%条件下，产品可保存一年。超过保存期的产品需重新检测后方可使用。

LED can be stored for a year under the condition: the temperature of 5℃~35℃ and humidity of RH60%，These production must be re-inspected and tested before use if their storage time exceed a year.

(2) 如果打开的产品在 5℃~35℃，RH60%的空气条件下放置超过一周，则需要将产品在 65℃±5℃的环境中放置 24 小时以上，并尽量在十五天内使用。

If LED is exposed in air for a week under the condition: the temperature of 5℃~35℃，humidity of RH60%，must place the LED in the ambience of 65℃±5℃ for 24 hours and use it in 15 days for best.

7、清洗 Cleaning

当用化学用品清洗胶体时必须特别小心，因为有些化学品对胶体表面有损伤并引起褪色如三氯乙烯、丙酮等。可用乙醇擦拭、浸渍，时间在常温下不超过 3 分钟。

Be careful of some chemical results in the LED colloid fades and damage when using chemical clean the LED，such as chloroethylene, acetone etc. Can use ethanol to wash or soak LED but the time don't exceed 3 minutes.

8、弯脚 Kinked

当 LED 成形弯脚时，弯脚模具容易刮花 LED 脚支架镀层，刮伤处容易生锈，特别是空气湿度大时。为减少生锈机会，建议使用镀锡支架。

The kinked tooling scrape easily the pin of LED, where the LED bracket is rusting easily, especial expose it in moist air. To decrease the LED bracket rust, advise using plated tin LED bracket.

X-ON Electronics

Largest Supplier of Electrical and Electronic Components

Click to view similar products for [Infrared Receivers](#) category:

Click to view products by [TONYU](#) manufacturer:

Other Similar products are found below :

[TSOP6136TT](#) [TSOP2456](#) [TSOP31456](#) [TSOP38336](#) [TSOP53356](#) [ZSPD-Z3020B-29C-Z5](#) [IRM-3638JT](#) [IRM-3638J15](#) [IRM-3638J7](#) [DY-PT928-6C](#) [DY-PD204-6C-L3](#) [ZSIRM-Z3QN88P\(LXM\)](#) [ZSIRM-Z1QN86](#) [ZSIRM-Z3QN88P\(CG\)](#) [IS471FSE](#) [ZSIRM-Z5PK81](#) [IRM-6638T](#) [IRM-H638T/TR2\(BY-1\)](#) [IRM-56384\(BY\)](#) [TSOP31140](#) [TSOP75238WTT](#) [RPM7238-H5R](#) [TSOP4156](#) [TSOP6156TR](#) [TSOP75338TR](#) [TSSP77038TT](#) [TSOP38138](#) [TSSP57P38TT1](#) [TSOP59438](#) [TSOP58336](#) [OSRB38C9AA](#) [TSOP75538WTT](#) [TSOP39336TR1](#) [TSOP75240TR](#) [TSOP75256TR](#) [TSOP53456](#) [TSOP53556](#) [TSOP75456TR](#) [TSOP37338TT1](#) [TSOP39338](#) [TSOP75256TT](#) [TSOP75336TR](#) [TSOP36156TT](#) [TSOP4838QJ1](#) [TSSP4038SS1XB](#) [TSOP39438TR1](#) [TSOP6133TR](#) [IS471FE](#) [PB11CNT15WR](#) [ZIRM-5042B-42-Z2](#)