



# UNI12 BCD/U

## SURFACE AND RECESSED PROFILE

### PROFIL WPUSTOWO-NAWIERZCHNIOWY

- decorative and lighting profile
- 7 diffusers to choose from
- increased radiation – it is possible to use a stronger LED strip
- maximum LED strip width: 12 mm
- profil oświetleniowo-dekoracyjny
- 7 kloszy do wyboru
- zwiększona radiacja - możliwość zastosowania mocniejszej taśmy LED
- maksymalna szerokość taśmy LED: 12 mm



## SIMILAR IN THE OFFER / PODOBNE W OFERCIE



DEEP10  
BC/UX



GROOVE10  
BC/UX



SURFACE10  
BC/UX



BEGTON12  
J/S



FLOOR12  
K/U



GROOVE14  
EF/TY



SURFACE14  
EF/TY



# UNI12 BCD/U

- B** slide cover  
klosz B wsuwany
- C** click cover  
klosz C klik
- C** lens cover  
klosz C soczewka
- D** click cover  
klosz D klik
- U**<sup>1</sup> flexible mounting plate  
uchwyt U sprężysty
- U**<sup>2</sup> cone U flexible mounting plate  
uchwyt U sprężysty cone

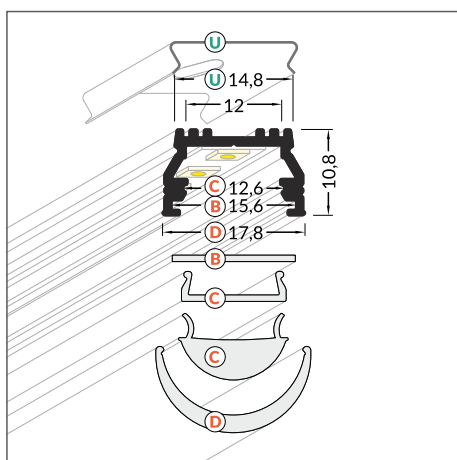
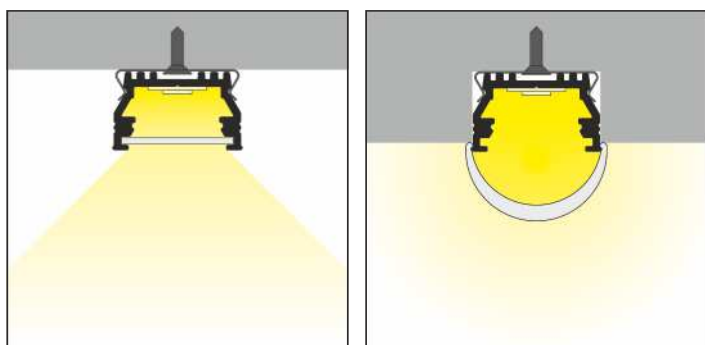
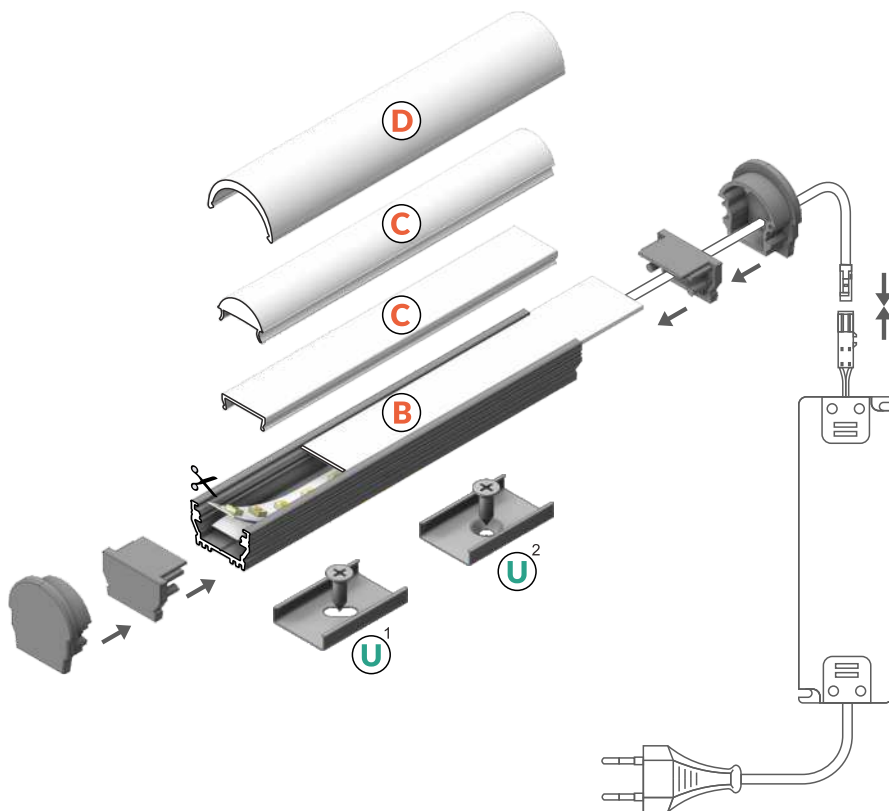

INDEX = 1 pc, length 2000 mm  
package = 10 pcs  
INDEKS = 1 szt., długość 2000 mm  
opakowanie = 10 szt.

○ white painted  
biały malowany  
A1020001

● anodized  
anodowany  
A1020020

● black anodized  
czarny anodowany  
A1020021

○ raw aluminium  
surowe aluminium  
A1020000

● max 12 mm

○ surface  
nawierzchniowy

● recessed  
wpustowy

Available lengths / Dostępne długości  
1000 mm, 2000 mm, 3000 mm, 4000 mm



## COVERS / KLOSZE

### B slide cover

colours: transparent, frosted, white  
material: PC, PP, PP

klosz B wsuwany  
kolory: transparentny, szron, mleczny  
materiał: PC, PP, PP



**Note!** Dimensions of the space to install LED source  
**Uwaga!** Wymiary przestrzeni do zamontowania źródła LED

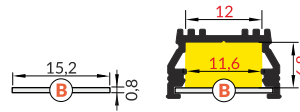

### C click cover

colours: transparent, white  
material: PMMA

klosz C klik  
kolory: transparentny, mleczny  
materiał: PMMA

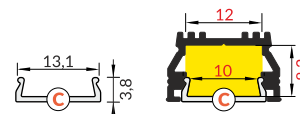

### C lens click cover

colour: transparent  
material: PC

klosz C klik soczewka  
kolor: transparentny  
materiał: PC

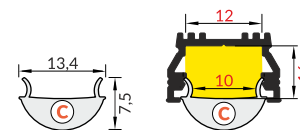

### D click cover

colour: white  
material: PMMA

klosz D klik  
kolor: mleczny  
materiał: PMMA

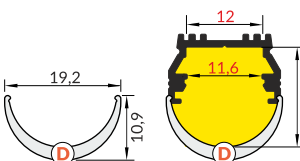

INDEX = 1 pc, length 2000 mm  
package = 10 pcs  
INDEKS = 1 szt., długość 2000 mm  
opakowanie = 10 szt.

B transparent / B transparentny  
76250016

B frosted / B szron  
76250039

B white / B mleczny  
76250038

C transparent / C transparentny  
76330000

C white / C mleczny  
76330038

C lens / C soczewka  
76300000

D white / D mleczny  
A1140038

## MOUNTINGS / MOCOWANIA

### U flexible mounting plate

colour: inox  
material: stainless steel

uchwyt U sprężysty  
kolor: inox  
materiał: stal nierdzewna

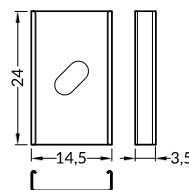
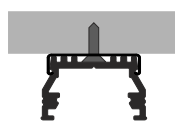

### cone U flexible mounting plate

colour: inox  
material: stainless steel

uchwyt U sprężysty cone  
kolor: inox  
materiał: stal nierdzewna

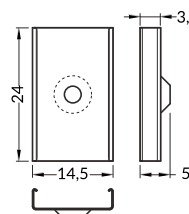
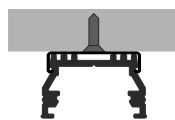

INDEX = 1 set  
package of 10 sets = 20 pcs  
INDEKS = 1 komplet  
opakowanie zawiera 10 kpl = 20 szt

U flexible mounting plate  
uchwyt U sprężysty

inox  
inox 76380000

cone U flexible mounting plate  
uchwyt U sprężysty cone

inox  
inox 76620000

## CONNECTORS / ŁĄCZNIKI

### UNI12 connector 90 deg

colours: white, anodized, black  
material: aluminium

łącznik UNI12 90 st  
kolory: biały, anodowany, czarny  
materiał: aluminium

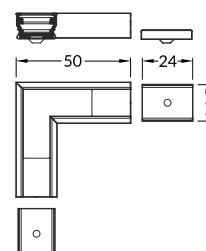

INDEX = 1 set  
INDEKS = 1 komplet

white painted  
biały malowany  
A1910001

anodized  
anodowany  
A1910020

black anodized  
czarny anodowany  
A1910021



## ENDINGS / ZAŚLEPKI

### UNI12 ending

colours: white, silver, black, grey  
material: ABS

zaślepka UNI12

kolory: biały, srebrny, czarny, szary  
materiał: ABS

### UNI12 ending with hole

colours: white, silver, black, grey  
material: ABS

zaślepka UNI12 z otworem

kolory: szary, czarny, biały, srebrny  
materiał: ABS

### UNI12 D ending

colours: white, silver, black, grey  
material: ABS

zaślepka UNI12 D

kolory: biały, srebrny, czarny, szary  
materiał: ABS

### UNI12 D ending with hole

colours: white, silver, black, grey  
material: ABS

zaślepka UNI12 D z otworem

kolory: szary, czarny, biały, srebrny  
materiał: ABS

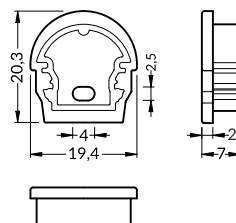
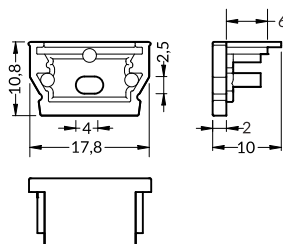

INDEX = 1 set  
package of 10 sets = 20 pcs  
INDEKS = 1 komplet, opakowanie  
zawiera 10 kompletów = 20 szt.

○ white / białe  
with hole z otworem | without hole bez otworu  
A1090001 | A1070001

● silver / srebrne  
with hole z otworem | without hole bez otworu  
A1090040 | A1070040

● black / czarne  
with hole z otworem | without hole bez otworu  
A1090002 | A1070002

● grey / szare  
with hole z otworem | without hole bez otworu  
A1090022 | A1070022

○ white / białe  
with hole z otworem | without hole bez otworu  
A1960001 | A1940001

● silver / srebrne  
with hole z otworem | without hole bez otworu  
A1960040 | A1940040

● black / czarne  
with hole z otworem | without hole bez otworu  
A1960002 | A1940002

● grey / szare  
with hole z otworem | without hole bez otworu  
A1960022 | A1940022



PL

Made in Poland  
Wyprodukowane w Polsce



EU-registered industrial design  
Wzory przemysłowe EU

TOPMET LIGHT Kłósowicz Wiśniewski i Wspólnik Sp. j. ADDRESS: Ostrowska 354, 61-312 Poznań, POLAND  
tel. +48 61 87 27 500, fax. +48 61 87 27 518 biuro@topmet.pl, www.topmet.pl

The catalogue is not an offer under Polish Civil Code regulations. Colours of particular products may vary slightly from colours shown in pictures. The dimensions given are approximate and can not be a reason for complaint. TOPMET Company reserves the right to make technical changes.  
Folder nie stanowi oferty w myśl przepisów Kodeksu Cywilnego. Aktualną ofertę firmy stanowi cennik. Kolory poszczególnych produktów mogą się nieznacznie różnić od kolorów prezentowanych na zdjęciach. Podane wymiary są wymiarami orientacyjnymi i nie mogą stanowić podstawy reklamacji. Firma TOPMET zastrzega sobie prawo do wprowadzania zmian technicznych.

brochure designer • proj. folderu: M. Kędziora, A. Szafran 11.2016. photo • fot. K. Samulska, A. Szafran, L. Wesołowski

## X-ON Electronics

Largest Supplier of Electrical and Electronic Components

*Click to view similar products for [Topmet](#) manufacturer:*

Other Similar products are found below :

[89160022](#) [C2970002](#) [86340022](#) [86490040](#) [89980001](#) [77260021](#) [77260001](#) [V4900022](#) [V4900040](#) [SMART-IN16 A/U4 ANOD 1M SET STD](#)  
[GROOVE10 C/U WH 1M SET STD](#) [BEGTON12 J/S WH 1M SET STD](#) [FLAT8 H/U ANOD 1M SET STD](#) [MIKRO10 ANOD 1M SET STD](#)  
[SMART10 A/Z WH 1M SET STD](#) [GROOVE14 F/Y WH 1M SET STD](#) [LINEA-IN20 F/U7 ANOD 1M SET STD](#) [SLIM8 A/Z ANOD 1M SET](#)  
[PRM](#) [FLAT8 H/U BK 1M SET PRM](#) [F9009902](#) [89060038P020](#) [23080038](#) [84060016P020](#) [76510002](#) [83160001](#) [98070001](#) [23070038](#)  
[76990022](#) [83990001](#) [A1910001](#) [B8910001](#) [A4010001](#) [V4880022](#) [V3010001](#) [V3090020S](#) [V3010000S](#) [FLAT8 H/U BK 1M SET STD](#)  
[SLIM8 A/Z WH 1M SET STD](#) [ARC12 D/U5 ANOD 1M SET STD](#) [CORNER14 F/Y ANOD 1M SET STD](#) [DEEP10 C/U BK 1M SET STD](#)  
[67120022](#) [A2050038](#) [92040022](#) [A1080040](#) [A2040016](#) [A2080002](#) [83980002](#) [98050040](#) [A3980002](#)