



SLIM8 A/Z

SMALL, ALUMINIUM, SURFACE PROFILE

MAŁY, ALUMINIOWY PROFIL NAWIERZCHNIOWY



- decorative lighting profile
- universal application
- Slick socket
- 2 channels for mounting bracket (with or without wall distance)
- painted holders
- maximum LED strip width: 8 mm
- profil dekoracyjno-oświetleniowy
- uniwersalne zastosowanie
- gniazdo Slick
- 2 rowki - 2 poziomy przymocowania uchwyty (z dystansem od ściany lub bez)
- malowane uchwyty
- maksymalna szerokość taśmy LED: 8 mm

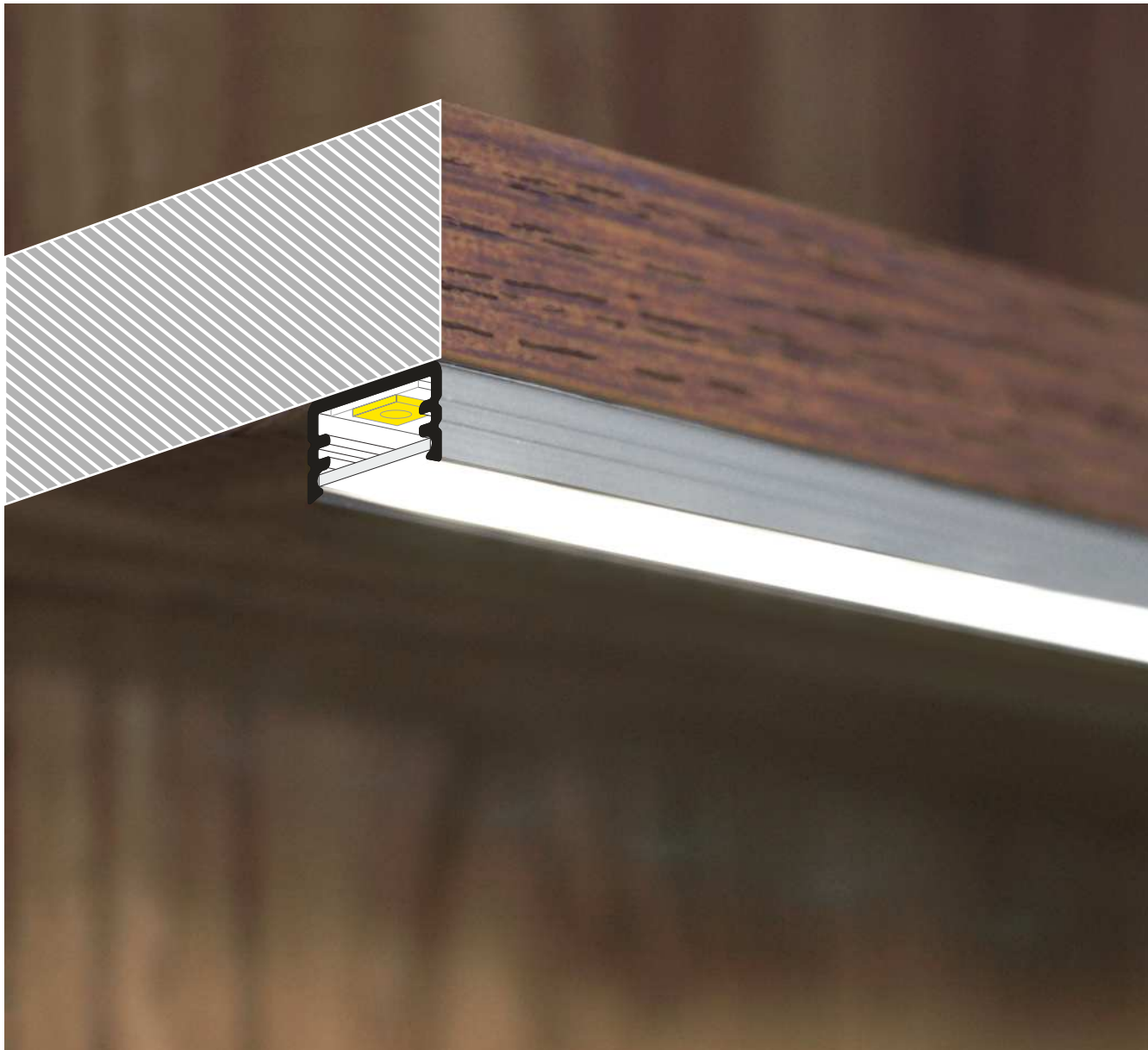

SIMILAR IN THE OFFER / PODOBNE W OFERCIE



SMART10
A/Z



SURFACE10
BC/UX



BEGTON12
J/S



SURFACE14
EF/TY





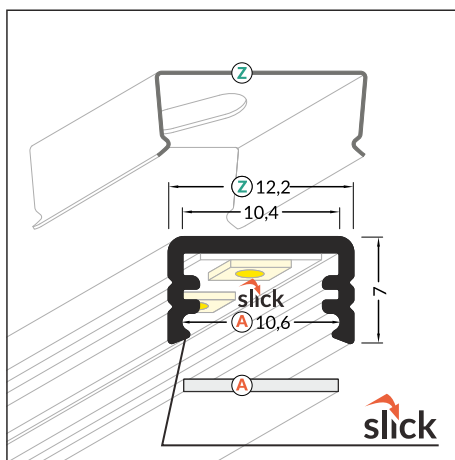
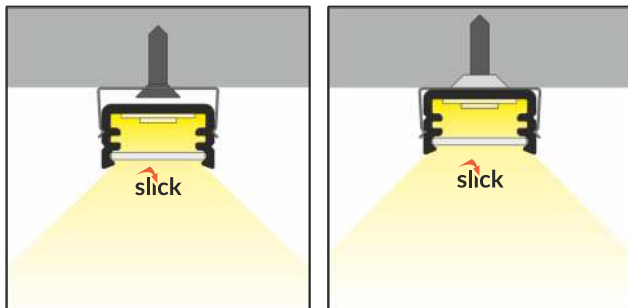
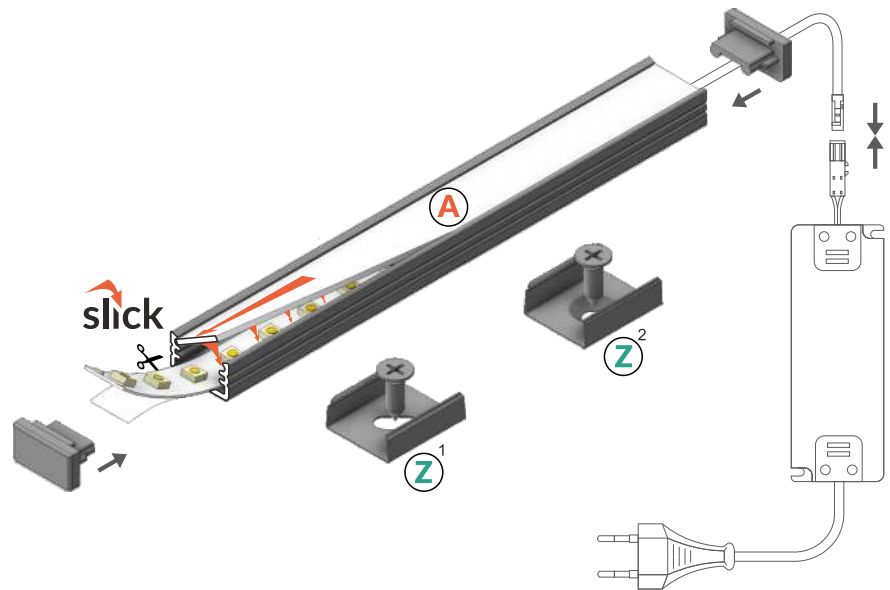

SLIM8 A/Z

- A** slide cover
klosz A wsuwany
- Z**¹ Z flexible mounting plate
uchwyt Z sprężysty
- Z**² cone Z flexible mounting plate
uchwyt Z sprężysty cone



INDEX = 1 pc, length 2000 mm
package = 10 pcs
INDEKS = 1 szt., długość 2000 mm
opakowanie = 10 szt.

-  white painted
biały malowany
89030001
-  anodized
anodowany
89030020
-  black anodized
czarny anodowany
89030021
-  raw aluminium
surowe aluminium
89030000

Available lengths / Dostępne długości
1000 mm, 2000 mm, 3000 mm, 4000 mm



COVERS / KLOSZE

A slide cover
colours: transparent, frosted, white
material: PC, PP, PP

klosz **A** wsuwany
kolory: transparentny, szron, mleczny
materiał: PC, PP, PP

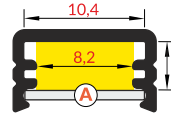
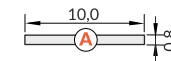

Note! Dimensions of the space to install LED source
Uwaga! Wymiary przestrzeni do zamontowania źródła LED



INDEX = 1 pc, length 2000 mm
package = 10 pcs
INDEKS = 1 szt., długość 2000 mm
opakowanie = 10 szt.

A transparent / A transparentny
89070016

A frosted / A szron
89070039

A white / A mleczny
89070038

ENDINGS / ZAŚLEPKI

SLIM8 ending
colours: white, silver, black, grey
material: ABS

zaślepka SLIM8
kolory: biały, srebrny, czarny, szary
materiał: ABS

SLIM8 ending with hole
colours: white, silver, black, grey
material: ABS

zaślepka SLIM8 z otworem
kolory: biały, srebrny, czarny, szary
materiał: ABS

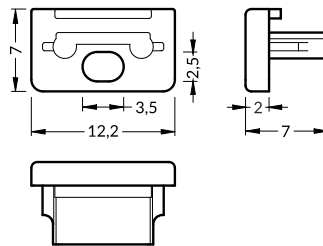

INDEX = 1 set
package of 10 sets = 20 pcs
INDEKS = 1 komplet, opakowanie zawiera 10 kompletów = 20 szt.

- white / białe

with hole z otworem	without hole bez otworu
89960001	89040001
- silver / srebrne

with hole z otworem	without hole bez otworu
89960040	89040040
- black / czarne

with hole z otworem	without hole bez otworu
89960002	89040002
- grey / szare

with hole z otworem	without hole bez otworu
89960022	89040022

MOUNTINGS / MOCOWANIA

Z flexible mounting plate
colours: white, inox, black
material: stainless steel

uchwyt **Z** sprężysty
kolory: biały, inox, czarny
materiał: stal nierdzewna

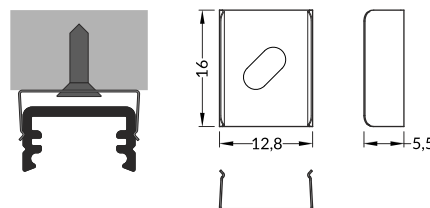

cone Z flexible mounting plate
colours: white, inox, black
material: stainless steel

uchwyt **Z** sprężysty cone
kolory: biały, inox, czarny
materiał: stal nierdzewna

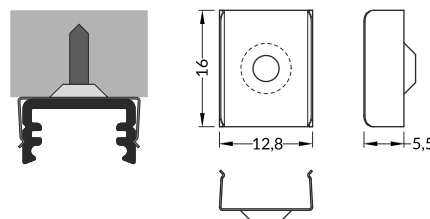

SLIM8 simple holder
material: zinc coated steel

uchwyt SLIM8 prosty
materiał: stal ocynkowana

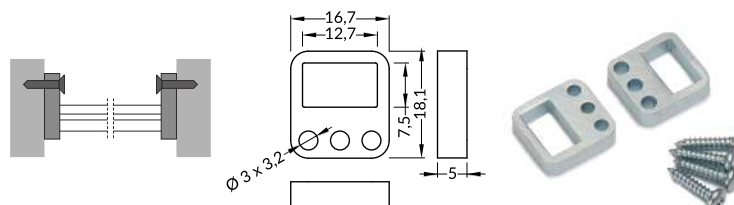

INDEX = 1 set
package of 10 sets = 20 pcs
INDEKS = 1 komplet, opakowanie zawiera 10 kpl = 20 szt.

Z flexible mounting plate
uchwyt **Z** sprężysty

- white biały 89270001
- inox inox 89270019
- black czarny 89270002

cone Z flexible mounting plate
uchwyt **Z** sprężysty cone

- white biały 89980001
- inox inox 89980019
- black czarny 89980002

INDEX = 1 set = 2 pcs
INDEKS = 1 komplet = 2 szt.

simple holder
uchwyt prosty

- zinc coated stal ocynkowana 89110030





CONNECTORS / ŁĄCZNIKI

SLIM8 L connector
colours: white, anodized, black
material: aluminium

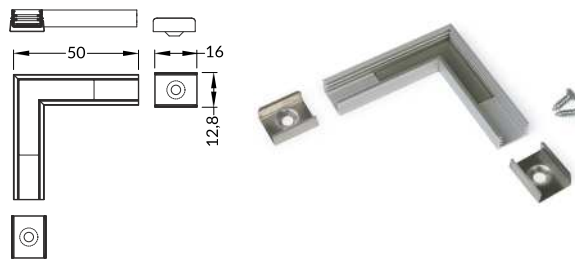
łącznik L SLIM8
kolory: biały, anodowany, czarny
materiał: aluminium



INDEX = 1 set
INDEKS = 1 komplet

-  white painted
biały malowany
89150001
-  anodized
anodowany
89150020
-  black anodized
czarny anodowany
89150021



PL

Made in Poland
Wyprodukowane w Polsce



EU-registered industrial design
Wzory przemysłowe EU

TOPMET LIGHT Kłósowicz Wiśniewski i Wspólnik Sp. j. ADDRESS: Ostrowska 354, 61-312 Poznań, POLAND
tel. +48 61 87 27 500, fax. +48 61 87 27 518 biuro@topmet.pl, www.topmet.pl

The catalogue is not an offer under Polish Civil Code regulations. Colours of particular products may vary slightly from colours shown in pictures. The dimensions given are approximate and can not be a reason for complaint. TOPMET Company reserves the right to make technical changes.
Folder nie stanowi oferty w myśl przepisów Kodeksu Cywilnego. Aktualną ofertę firmy stanowi cennik. Kolory poszczególnych produktów mogą się nieznacznie różnić od kolorów prezentowanych na zdjęciach. Podane wymiary są wymiarami orientacyjnymi i nie mogą stanowić podstawy reklamacji. Firma TOPMET zastrzega sobie prawo do wprowadzania zmian technicznych.

brochure designer • proj. folderu: M. Kędziora, A. Szafran 11.2016. photo • fot. K. Samulska, A. Szafran, L. Wesolowski

X-ON Electronics

Largest Supplier of Electrical and Electronic Components

Click to view similar products for [Topmet manufacturer:](#)

Other Similar products are found below :

[23040001](#) [23040020S](#) [23040021](#) [23070038](#) [23080038](#) [23110022](#) [23110040](#) [23120001](#) [23120002](#) [23120022](#) [23120040](#) [23130000](#) [63520001](#)
[63680038](#) [67120001](#) [67120002](#) [67120022](#) [67140003](#) [67230040](#) [68550022](#) [68550040](#) [70290000](#) [70290022](#) [70290040](#) [70300022](#) [70300040](#)
[70320039](#) [70330038P020](#) [70360001](#) [70360022](#) [70360040](#) [76200001](#) [76250038P020](#) [76260000](#) [76350000](#) [76360038S](#) [76480002](#) [76500001](#)
[76510001](#) [76510002](#) [76530020](#) [76530021](#) [76620000](#) [76990002](#) [76990022](#) [76990040](#) [77260001](#) [77260021](#) [77280001](#) [77280022](#)