



TOPMET[®]

30

**30 years of providing
lighting solutions**

30 lat dostarczania
rozwiązań
oświetleniowych

COVERS / KLOSZE

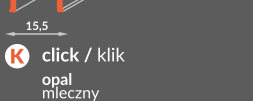
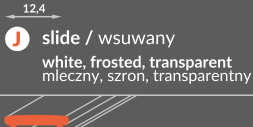
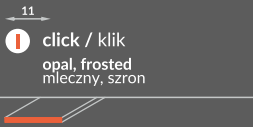
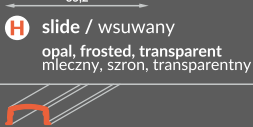
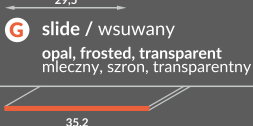
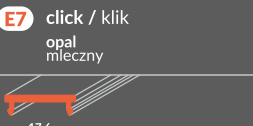
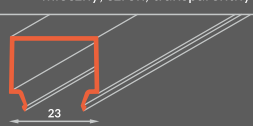
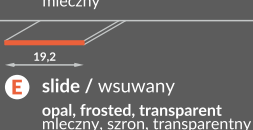
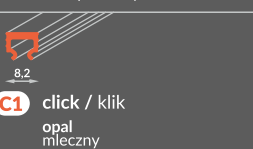
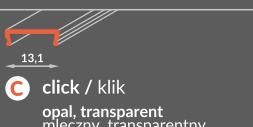
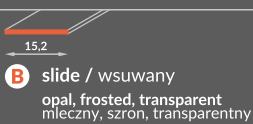
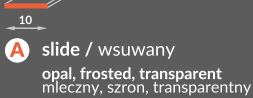

MOUNTINGS / MOCOWANIA



T connector 180 deg
łącznik T 180 st

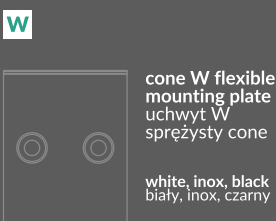

white, inox, black
biały, inox, czarny



X connector 180 deg
łącznik X 180 st



white, inox, black
biały, inox, czarny

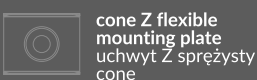

white, inox, black
biały, inox, czarny



TOPMET[®]

2020

LED profiles
profile LED



TOPMET LED profiles
profile LED TOPMET

Tutorial / Krok po kroku 1.01



surface LED profiles
profile LED nawierzchniowe

SLIM8 AC2/Z	2.01
SMART10 AC2/Z	2.05
SURFACE10 BC/UX	2.09
BEGTON12 J/S	2.13
UNI12 BCD/U	2.17
SURFACE14 EF/TY	2.21
SMART16 BC3/U4	2.25
LINEA20 EF/TY	2.29
WIDE24 G/W	2.41

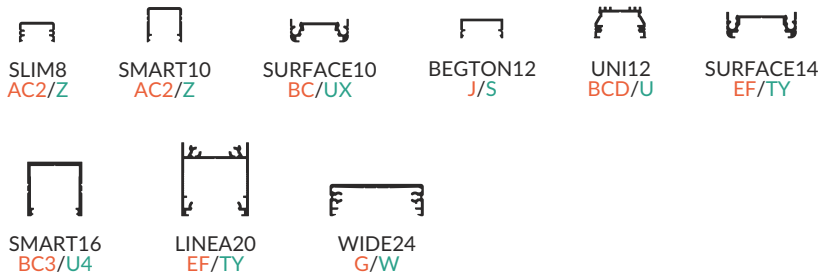

recessed LED profiles
profile LED wpustowe

FLAT8 H/UX	3.01
HI8 C1	3.05
SLASH8	3.09
DEEP10 BC/UX	3.13
GROOVE10 BC/UX	3.17
SMART-IN10 AC2/Z	3.21
BEGTIN12 J/S	3.25
FLOOR K	3.29
FLOOR8 K	3.31
FLOOR12 K/U	3.33
GROOVE14 EF/TY	3.35
SMART-IN16 BC3/U4	3.39
LINEA-IN20 EF/U7	3.43
LINEA-IN20 TRIMLESS EF/U7	3.51

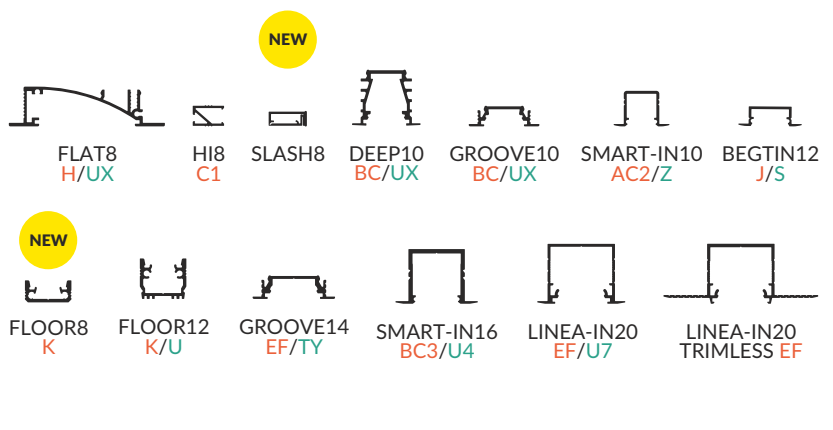

corner LED profiles
profile LED kątowe

TRIO10 BC	4.01
CORNER10 BC/UX	4.05
QUARTER10 BD/U6	4.09
CABI12 E	4.13
CORNER14 EF/TY	4.17
CORNER27 G/UX	4.21



special application LED profiles
profile LED specjalne

PEN8 I	5.01
BACK10 A/UX	5.05
STEP10 C	5.09
WAY10 C	5.13
ARC12 CD/U5	5.17
FIX12 / FIX16	5.21
WALLE12 BCD	5.23
PEN12 CJ	5.27
UNI-TILE12 C	5.31
FRAME14 BC/Q	5.37
OVAL20 BC	5.41

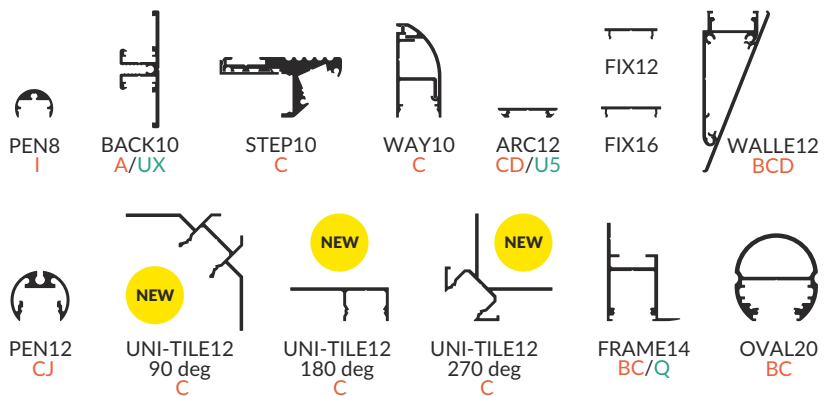

glass application LED profiles
profile LED do szkła

TWIN8	6.01
MIKRO10	6.03
EDGE10 BC	6.05
MIKRO-LINE12 J	6.09



VARIO30

VARIO30-01	7.06
VARIO30-02	7.06
VARIO30-03	7.06
VARIO30-08	7.06

VARIO30-09	7.07
VARIO30-10	7.07
FIX16	7.07

VARIO30-04	7.14
VARIO30-05	7.14
VARIO30-06	7.14
VARIO30-07	7.14

SURFACE / NAWIERZCHNIOWE

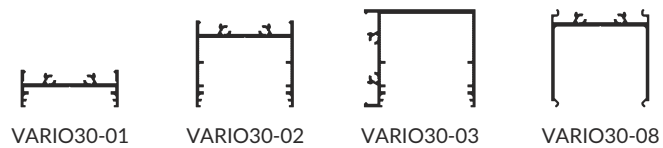

POWER SUPPLY PROFILE PROFIL ZASILAJACY

ASSISTANT PROFILES PROFILE POMOCNICZE

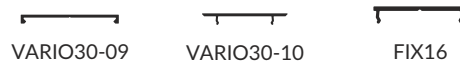

RECESSED - SPACKLE FLANGE MOUNTING WPUSTOWE DO SZPACHLOWANIA

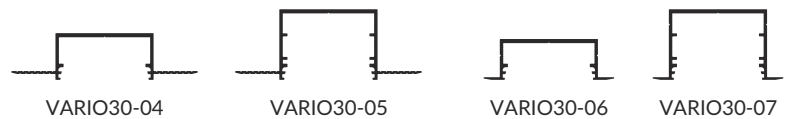

RECESSED WPUSTOWE

big profiles duże profile

PHIL53	8.01
PHIL recessed / PHIL wpust	8.02
LOWI	8.02

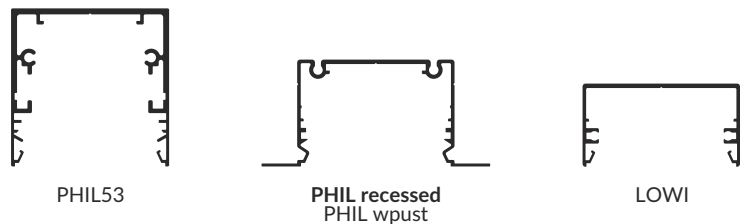

LED accessories akcesoria LED

24 V PREMIUM LED strips / taśmy LED z serii PREMIUM 24 V	9.01
24 V PREMIUM LED modules / moduły LED z serii PREMIUM 24 V	9.05
12 V LED sources / źródła LED 12 V	9.06
24 V LED power supplies / zasilacze LED 24 V	9.07
12 V LED power supplies / zasilacze LED 12 V	9.08
power supply cases / obudowy do zasilaczy	9.09
lighting controllers and switches / czujniki sterujące i włączniki	9.10
Vario white lighting system / system oświetlenia Vario white	9.13
RGB lighting system / system oświetlenia RGB	9.14
cables, extensions, connectors / przewody, przedłużacze, złączki	9.15
LED profile slings / zawiesia do profili LED	9.16
tilted bracket for LED profiles / uchwyt uchylony do profili LED	9.16
other accessories / pozostałe akcesoria	9.17

general information informacje ogólne

Why LED profiles? / Dlaczego profile LED?	10.01
LED technology / technologia LED	10.03

sales support wsparcie sprzedaży

Sales support / Wsparcie sprzedaży	11.1
------------------------------------	------



2020 LED PROFILES PROFILE LED



TOPMET LED PROFILES - TUTORIAL / PROFILE LED TOPMET - KROK PO KROKU

TOPMET profile categories / Kategorie profili TOPMET



SURFACE / NAWIERZCHNIOWE

LED profiles with the most universal applications. Installation on a flat surface, most commonly with the use of aluminium holders or steel flexible mounting plates but also with the use of screws, or assembly tapes. It is worth to note the profiles with hidden mounting: SURFACE10, SURFACE14 and LINEA20.

Profile LED o najbardziej uniwersalnych zastosowaniach. Montaż na płaskiej powierzchni, najczęściej za pomocą uchwytów aluminiowych lub stalowych sprężystych, ale także wkretów, taśm montażowych. Warto zwrócić uwagę na profile z ukrytym mocowaniem: SURFACE10, SURFACE14 oraz LINEA20.

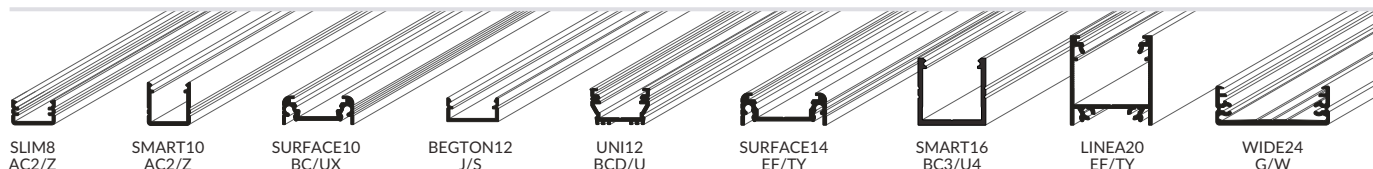

RECESSED / WPUSTOWE

The advantage of recessing a profile is obtaining an illuminating surface which almost levels with the plane of the wall or furniture. Profile installation requires surface preparation - cutting a longitudinal opening in the furniture (HI8, SLASH8, GROOVE10, BEGTIN12, GROOVE14), a plasterboard (FLAT8, DEEP10) or leaving an appropriate distance when installing the tiles (FLOOR8, FLOOR12).

Zaletą wpuszczenia profilu jest uzyskanie powierzchni świecącej niemalże licującej się z płaszczyzną ściany lub mebla. Montaż profili wymaga przygotowania powierzchni - wycięcie podłużnego otworu w meblu (HI8, SLASH8, GROOVE10, BEGTIN12, GROOVE14), w płycie gipsowo-kartonowej (FLAT8, DEEP10) lub pozostawienia odpowiedniego dystansu przy montażu płytek (FLOOR8, FLOOR12).

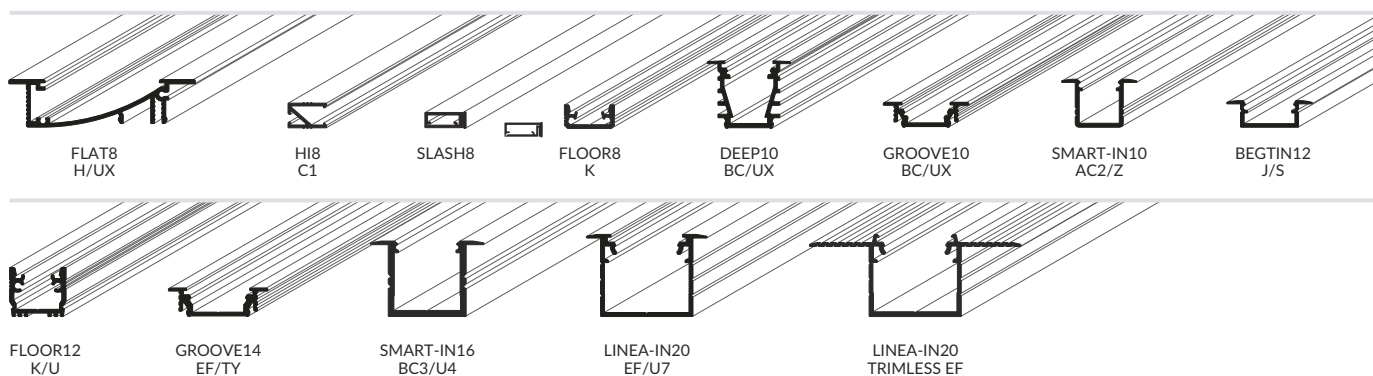

CORNER / KĄTOWE

To be used in the corners of wall, furniture and cabinets. Installation with mounting plates, screws, assembly tape. The asset of the CORNER10, CORNER14 and CORNER27 collections is the hidden mounting. These profiles provide a possibility to direct the light at an angle of 30° or 60° to the assembly plane. The CABI12 profile is designed for glass cabinets, then adhesive mounted. It allows to avoid glare. Installation at an angle of 30° or 60°. Thanks to the symmetric cross-section, the profiles can be joined in the corners at an angle of 90°. TRIO10, QUARTER10 - for lighting at an angle of 45°.

Do zastosowania w narożnikach ścian, mebli i gablot. Montaż na uchwyty, wkrety, taśmę montażową. Atutem kolekcji CORNER10, CORNER14 i CORNER27 jest ukryte mocowanie. Profile te dają możliwość skierowania światła pod kątem 30° lub 60° do płaszczyzny montażu. Profil CABI12 zaprojektowany do szklanych gablot, montowany na klej. Pozwala uniknąć oślnienia. Montaż pod kątem 30° lub 60°. Dzięki symetrycznemu przekrojowi profile można łączyć w narożnikach pod kątem 90°. TRIO10, QUARTER10 - do oświetlania pod kątem 45°.





SPECIAL APPLICATION / SPECJALNE

A group of profiles with a broad application spectrum - for the ceiling, wall, architectural, stair, wardrobe. Designed for special applications. Among them, the PEN8 with the highest number of holders (i.a.: extension arms, flat, simple and stretcher holders) for creating a number of combinations and achieving the defined illumination effects.

Grupa profili o szerokim spektrum przeznaczenia – ściennie, sufitowe, architektoniczne, schodowe, garderobiane. Zaprojektowane do specjalistycznych zastosowań. Wśród nich PEN8 z największą ilością uchwytów (m.in.: wysięgniki, płaskie, proste, rozporowe) do tworzenia szeregu kombinacji i osiągnięcia określonych efektów świetlnych.

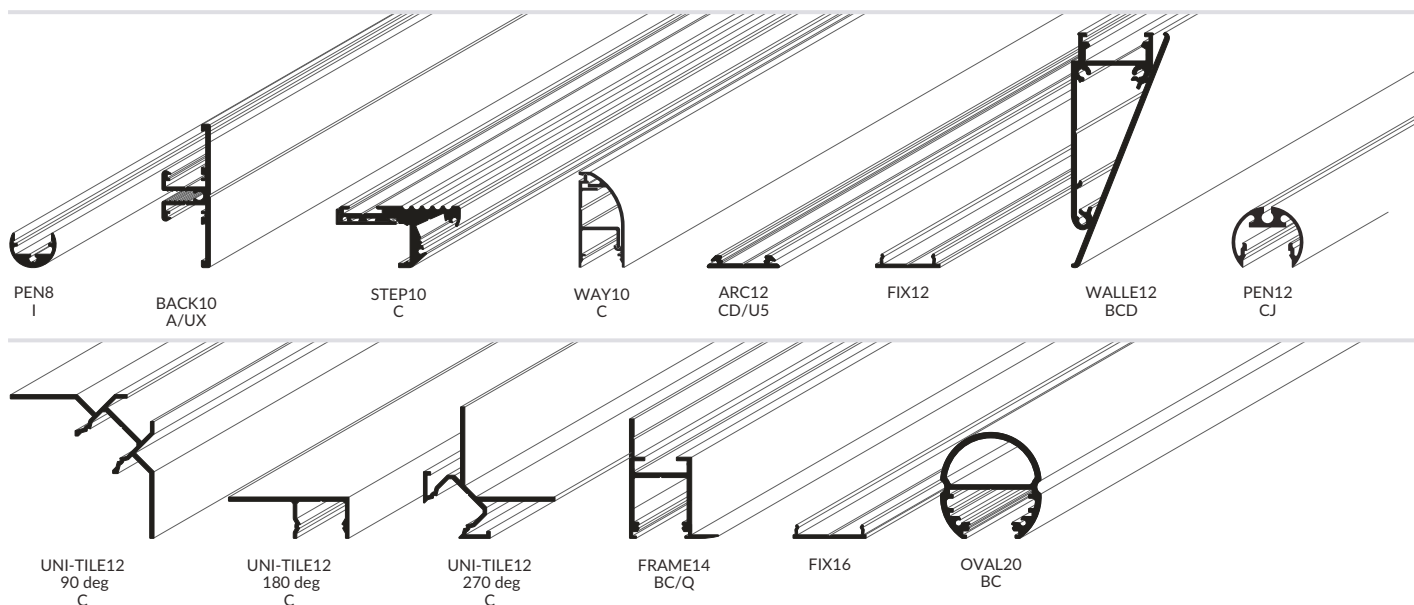

GLASS APPLICATION / DO SZKŁA

Profiles for glass are used to exhibit objects in cabinets and to illuminate the sanded advertising or decorative graphics. Installed on the edge of the glass panel, they do not constitute a shelf supporting structure. EDGE10 - in contrast to the other ones - is applied on the face of the shelf, which allows to better light up the exhibits under the shelf or above it (after rotating the profile by 180°).

Profile do szyb służą do ekspozycji przedmiotów w gablotach, podświetlają wypiszkowaną grafikę reklamową lub ozdobną. Montowane na krawędzi szklanej tafli, nie stanowią jednak konstrukcji podtrzymującej półki. EDGE10 - w przeciwieństwie do pozostałych - nakłada się od czopa półki, co pozwala lepiej oświetlić eksponaty pod półką lub nad nią (po obróceniu profilu o 180°).



SURFACE10 BC/UX

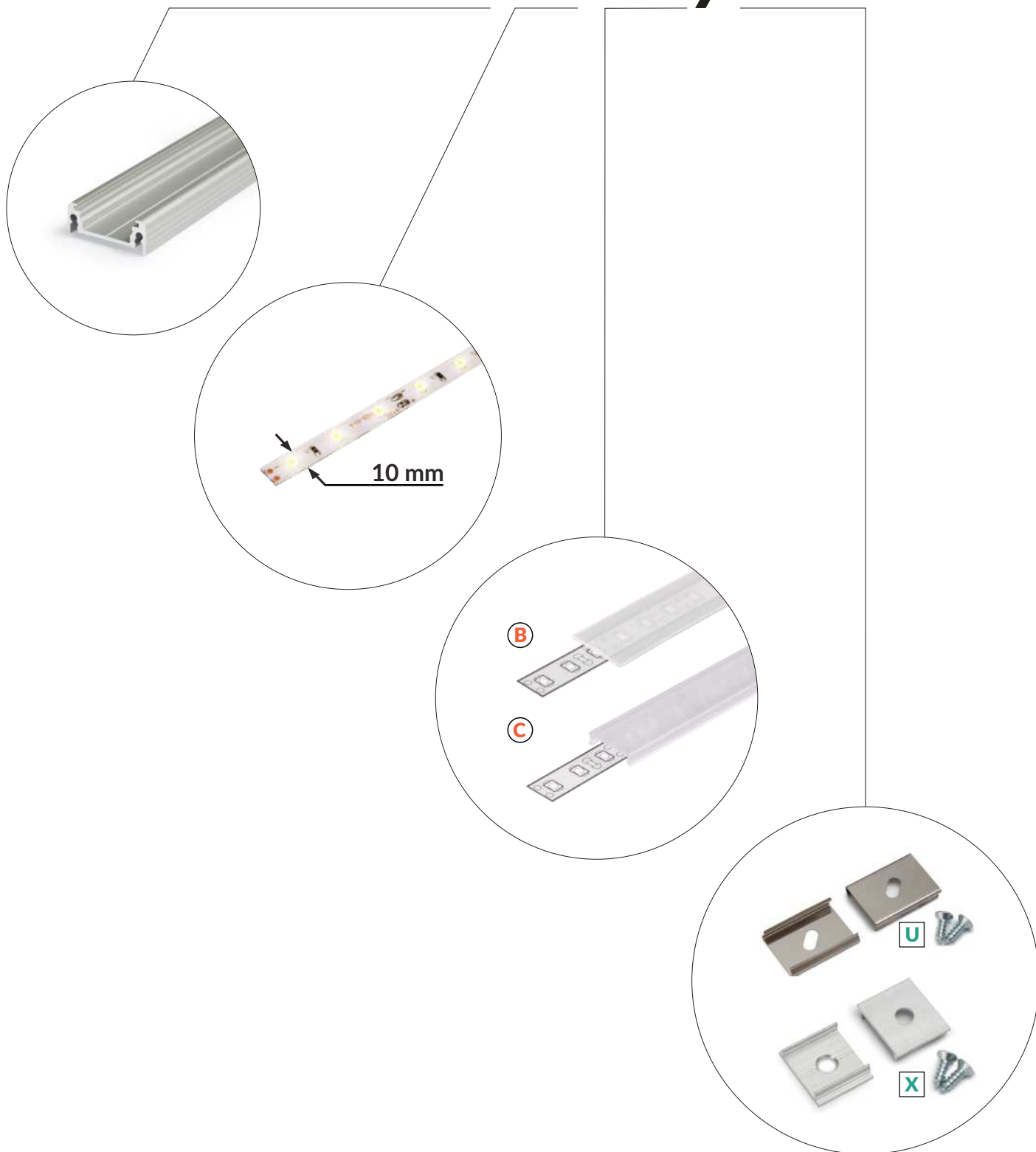

Slick

We also have profiles with the Slick socket in our assortment. This feature allows to click in or slide in the cover.

W naszym asortymencie posiadamy także profile z gniazdem Slick. Funkcja ta pozwala na łatwe „wklikiwanie” lub wsuwanie klosza.

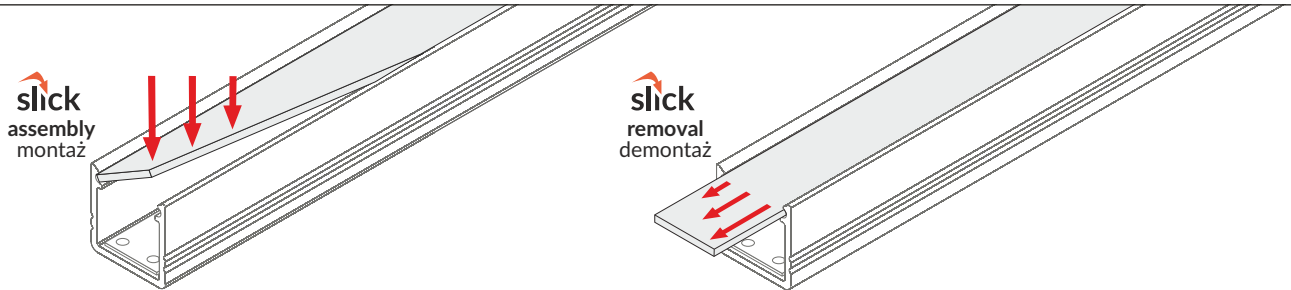

Profiles with Slick socket:

Poniżej profile wyposażone w gniazdo Slick:

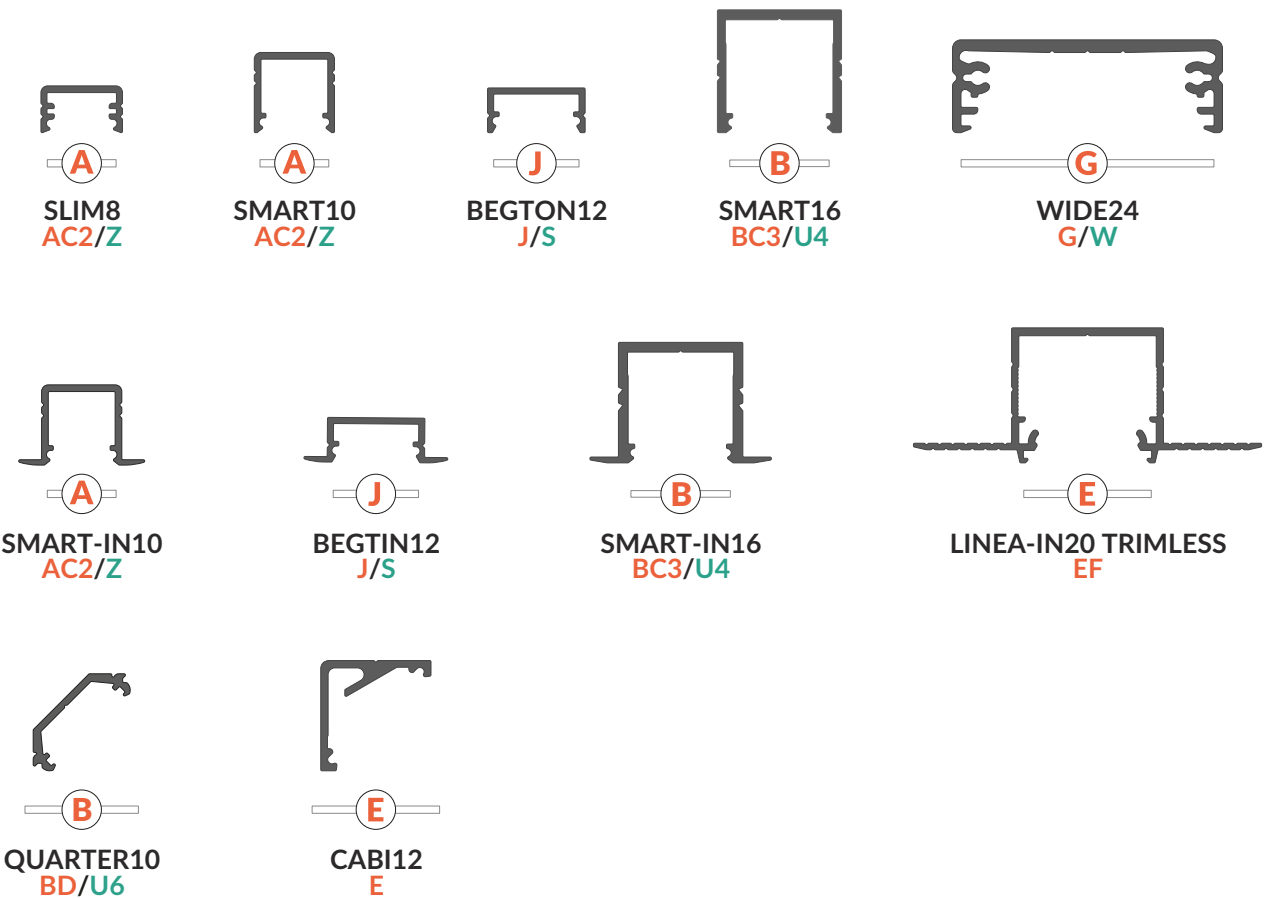

How to select a cover? / Jak dobrać klosz?

Covers for aluminium LED profiles differ in the degree of transparency. Thanks to a conscious choice, you can plan the lighting effect, light dispersion and distribution better. A transparent cover absorbs a smaller amount of light, followed by frosted and opal ones.

Klosze do profili aluminiowych LED różnią się stopniem transparentności. Dzięki świadomemu wyborowi można lepiej zaplanować efekt świetlny, rozproszenie i rozsył światła. Klosz transparentny pochłania najmniejszą ilość światła, dalej szron i mleczny.

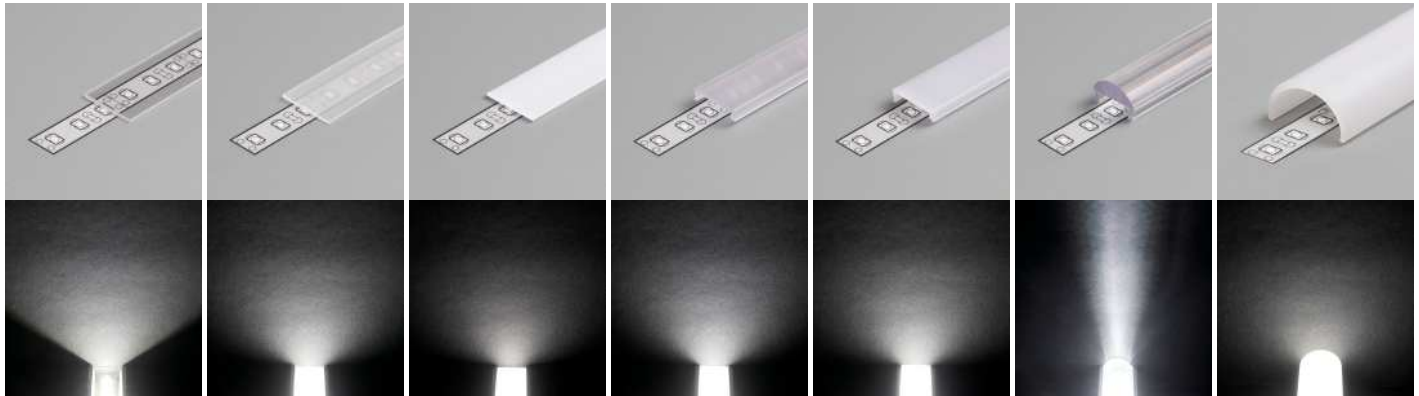

B slide transparent
B wsuwany transparentny

B slide frosted
B wsuwany szron

B slide opal
B wsuwany mleczny

C click transparent
C klik transparentny

C click opal
C klik mleczny

C click lens
C klik soczewka

D click opal
D klik mleczny

SPECIAL COVERS

Familiarise yourself with the interesting lighting effects provided by more specialised diffusers.

KLOSZE SPECJALNE

Warto zapoznać się również z ciekawymi efektami świecenia jakie dają bardziej specjalistyczne klosze.

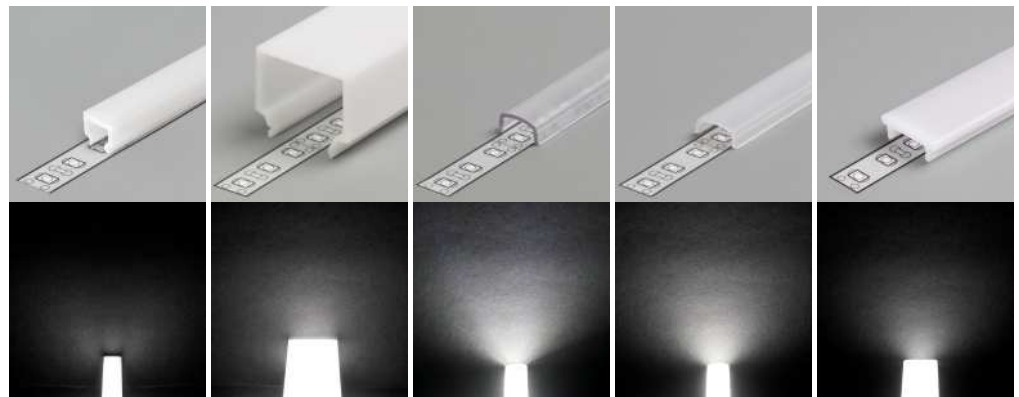

C1 click opal
C1 klik mleczny
HI8_____>3.05

E7 click opal
E7 klik mleczny
LINEA20_____>2.29
LINEA-IN20____>3.43
LINEA-IN20____>3.51
TRIMLESS
SURFACE14____>2.21
GROOVE14____>3.35
CORNER14____>4.17

I click frosted
I klik szron
PEN8_____>5.01

I click opal
I klik mleczny
PEN8_____>5.01

K click opal
K klik mleczny
FLOOR8_____>3.31
FLOOR12____>3.33

It also means a different degree of visibility of LED points. Opal covers in some profiles, in conjunction with a 120 P/m tape, allow to achieve the effect of a continuous line of light.

Oznacza to także różny stopień widoczności punktów LED. Klosze mleczne w niektórych profilach w połączeniu z taśmą 120 P/m pozwalają osiągnąć efekt ciągłej linii światła.

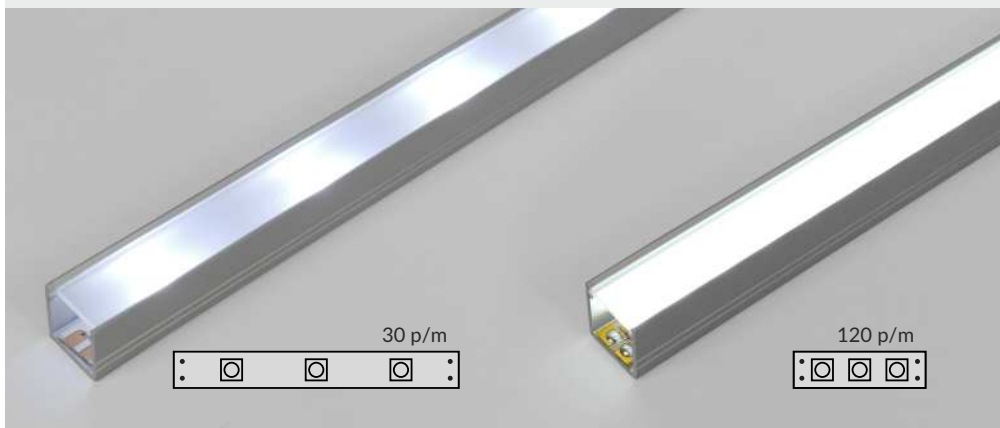

Tip / Wskazówka:

If we want to obtain a continuous line of light with a shallow profile, it is worth to use a very dense LED strip 240 P/m. See > 9.03

Jeśli chcemy uzyskać ciągłą linię światła w płytkim profilu, warto zastosować bardzo gęstą taśmę LED 240 pkt./m. Zobacz > 9.03

The covers also differ in the method of assembly.

SLIDE COVER (labelling: A, B, E, G, H, J)

It is a strip of plastic available in 3 different degrees of transparency. It needs to be slid from the beginning of the profile and dragged along the marked socket or clicked in the Slick socket.

CLICK COVER (labelling: C, C1, C2, C3, D, E7, F, I, K)

Its assembly and removal are more convenient. Access to the ends of the profile is not necessary, which allows to click in the cover even after installing the profile in a recess or a piece of furniture.

Klosze różnią się także sposobem montażu.

KLOSZ WSUWANY (oznaczenia: A, B, E, G, H, J)

Jest to pasek tworzywa dostępny w 3 różnych stopniach transparentności. Należy go wsunąć od początku profilu i przeciągnąć wzdłuż oznaczonego gniazda lub „wkliknąć” w gniazdo Slick.

KLOSZ KLIK (oznaczenia: C, C1, C2, C3, D, E7, F, I, K)

Jego montaż i demontaż jest wygodniejszy. Dostęp do końców profilu nie jest konieczny, co pozwala wkliknąć klosz nawet po zamontowaniu profilu we wnęce lub w meblu.



Many of the covers in the TOPMET offer are system accessories. It means that one cover fits a few, different profiles.

A letter describing the socket helps correct matching.

And so, e.g., the SURFACE10 BC/UX profile can be fitted with the covers:

- B slide
- C click
- C lens

Cover C click, on the other hands, fits the profiles:

- SURFACE10 BC/UX
- UNI12 BCD/U
- GROOVE10 BC/UX
- DEEP10 BC/UX
- TRIO10 BC
- CORNER10 BC/UX
- STEP10 C
- WAY10 C
- WALLE12 CD
- ARC12 CD/U5
- PEN12 CJ
- UNI-TILE12 C
- FRAME14 BC/Q
- OVAL20 BC
- EDGE10 BC

W ofercie TOPMET wiele spośród kloszy to akcesoria systemowe. Oznacza to, że ten sam klosz pasuje do kilku różnych profili.

W odpowiednim dopasowaniu pomaga litera opisująca gniazdo.

I tak np. do profilu LED SURFACE10 BC/UX pasują klosze:

- B wsuwany
- C klik
- C soczewka

Klosz C klik z kolei pasuje do profili:

- SURFACE10 BC/UX
- UNI12 BCD/U
- GROOVE10 BC/UX
- DEEP10 BC/UX
- TRIO10 BC
- CORNER10 BC/UX
- STEP10 C
- WAY10 C
- WALLE12 CD
- ARC12 CD/U5
- PEN12 CJ
- UNI-TILE12 C
- FRAME14 BC/Q
- OVAL20 BC
- EDGE10 BC

20 m reel Rolka 20 m

Long lines of light without connection gaps.
Minimizing cutting waste.
For C and F click opal covers
we introduce 20metre long lengths,
rolled up on a reel,
packed in a convenient cartonbox.

Długie linie światła bez żadnych szczelin.
Zminimalizowanie odcinków odpadowych.
Dla kloszy C oraz F klik mlecznych
wprowadzamy długie 20-metrowe odcinki
zwinęte w rolkę
oraz zapakowane w wygodny karton.



C2 click / klik

Click covers for profiles:
Klosze klik dla profili:

SLIM8
SMART10
SMART-IN10

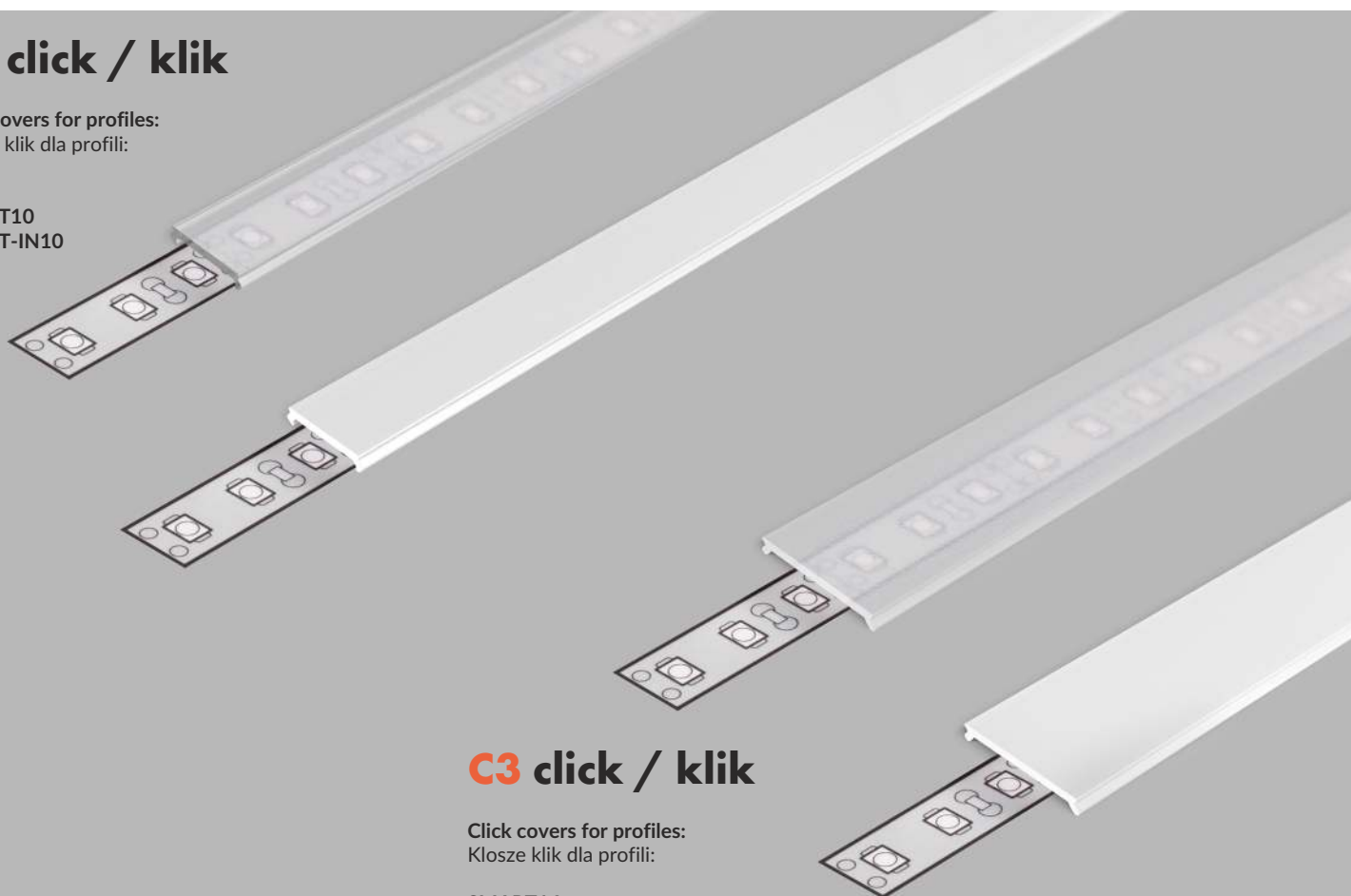

C3 click / klik

Click covers for profiles:
Klosze klik dla profili:

SMART16
SMART-IN16

BLACK IS WHITE CZARNE JEST BIAŁE

NEW

BLACK COVERS C, F

CZARNE KLOSZE C, F

- 70% light transmission
- the cover does not change the colour of the light
- przepuszczalność światła na poziomie 70%
- klosz nie zmienia barwy światła



Note! The best effect is achieved by using black covers with black LED profiles
Uwaga! Najlepszy efekt uzyskasz stosując czarne klosze z czarnymi profilami LED

Comparison of black and opal cover Porównanie klosza czarnego z mlecznym

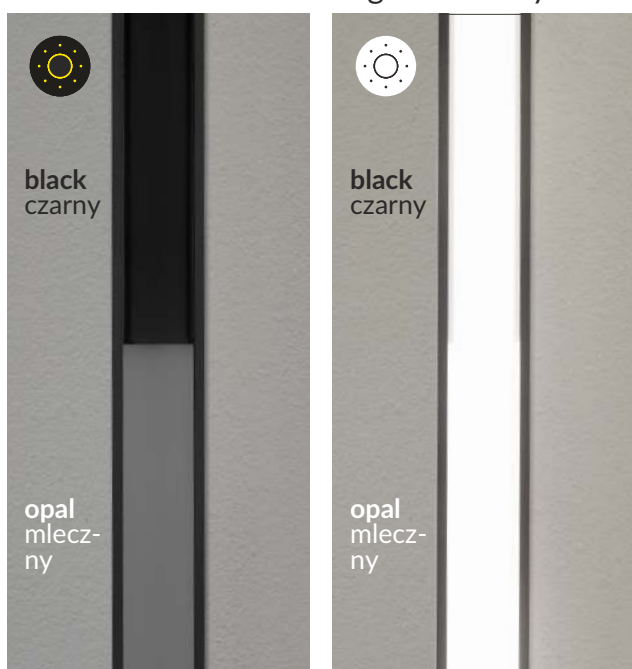

length 2000 mm
package > check the pricelist
długość 2000 mm
opakowanie > patrz cennik

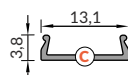
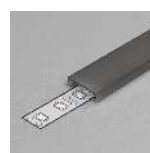

C click cover
colour: black
material: PMMA
klosz C klik
kolor: czarny
materiał: PMMA

index = 1 pc / indeks = 1 szt.
76330041

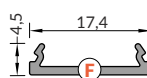

F click cover
colour: black
material: PMMA
klosz F klik
kolor: czarny
materiał: PMMA

index = 1 pc / indeks = 1 szt.
A2060041

The standard cover length tolerance is +20 mm.
More details >> 1.08.

Standardowa tolerancja długości kloszy wynosi: +20 mm
Więcej informacji >> 1.08.

Comparison of technical parameters of C and F covers Porównanie parametrów technicznych kloszy C i F

cover type rodzaj klosza	material materiał	work temperature temperatura stosowania		UV resistance odporność na UV	fire hazard certificate according to IEC 60695-2-11 certyfikat na palność wg PN-EN 60695-2-11	transparency transparentność	coefficient diffusion współczynnik rozproszenia
		min [°C]	max [°C]				
C F transparent transparentny	PMMA	-20	70	✓	✓	93%	low niski
C F opal mleczny	PMMA	-20	70	✓	✓	75%	low niski
C F black czarny NEW	PMMA	-40	75	✓	✓	70%	medium średni

Covers / Klosze

The covers in the TOPMET offer differ between one another not only in terms of the achieved lighting effect but also in terms of technical parameters. Among the special cover, one stands out in particular - designed for the FLOOR8 and FLOOR12 LED profiles, the K opal cover. Its characteristic feature is the high resistance to damage and impacts with a degree of IK 08. This is why it is possible to tread over it - without having to worry about cracking or scratching.

Klosze z oferty TOPMET różnią się między sobą nie tylko uzyskanym efektem świetlnym, ale również parametrami technicznymi. Wśród kloszy specjalnych wyróżnia się zwłaszcza jeden - przeznaczony do profili LED FLOOR8 i FLOOR12, czyli klosz K mleczny. Jego cechą charakterystyczną jest wysoka odporność na uszkodzenia oraz udary o stopniu IK 08. Dzięki temu możliwe jest chodzenie po nim - bez obaw o pęknięcie czy zarysowania.

cover type rodzaj klosza	material materiał	work temperature temperatura stosowania		UV resistance odporność na UV	fire hazard certificate according to IEC 60695-2-11 certyfikat na palność wg PN-EN 60695-2-11	transparency transpa- rentność	coefficient diffusion współczynnik rozproszenia
		min [°C]	max [°C]				
(A) (B) (E) (G) (H) (J) transparent transparentny	PC	-50	100	✓	✓	93%	low niski
(A) (B) (E) (G) (H) (J) frosted szron	PP	-15	85	✓	✓	90%	low niski
(A) (B) (E) (G) (H) (J) opal mleczny	PP	-15	85	✓	✓	70%	high wysoki
(C) (F) transparent transparentny	PMMA	-20	70	✓	✓	93%	low niski
(C) (F) opal mleczny	PMMA	-20	70	✓	✓	75%	low niski
(C) lens soczewka	PC	-50	100	✓	✓	90%	low niski
(C1) opal mleczny	PMMA	-20	70	✓	✓	70%	high wysoki
(C2) (C3) transparent transparentny	PMMA	-25	120	✓	✓	93%	low niski
(C2) (C3) opal mleczny	PMMA	-25	120	✓	✓	75%	low niski
(D) opal mleczny	PMMA	-20	70	✓	✓	70%	high wysoki
(E7) opal mleczny	PMMA	-20	70	✓	✓	70%	high wysoki
(I) frosted szron	PC	-50	100	✓	✓	90%	low niski
(I) opal mleczny	PC	-50	100	✓	✓	80%	medium średni
(K) opal mleczny	PC	-50	100	✓	✓	60%	high wysoki

Tolerance / Tolerancja

We make every effort to maintain maximum repeatability of our products. Despite this, there may be small differences between the individual batches due to the nature of the manufacturing processes. That is why we always recommend considering the following tolerances.

LENGTH	
	Standard tolerance*
PROFILES	+3 mm
CLICK COVERS: 1 m, 2 m, 3 m (except listed below)	+5 mm
CLICK COVERS: 2 m - C9, D9, E7, E9	+20 mm
CLICK COVERS: 4 m	+150 mm
SLIDE COVERS	+20 mm

*It is possible to prepare product with a narrowed, special tolerance. Please ask your key account manager for details. Cutting of the products is carried out at a temperature of 20°C.

TEMPERATURE EXPANSION	
	Value stated for the difference of 10°C, per linear metre
PROFILES	up to ~0,2 mm
COVERS	C10 NARROW: up to 0,7 mm
	C10 WIDE: up to 0,7 mm
	C10 OPAL: up to 0,8 mm
	others: 0,2~0,3 mm

DIMENSIONS OF CROSS SECTION
For all provided profile dimensions we apply tolerances in accordance with PN-EN 755-9.

COLOUR	
ANODIZED SURFACES	silver: C-0
	black: C-35
PAINTED SURFACES (according to the RAL palette)	white: RAL 9003 mat
	black: RAL 9005 mat

Dokładamy wszelkich starań, aby utrzymać maksymalną powtarzalność naszych produktów. Mimo to pomiędzy poszczególnymi partiami występować mogą drobne różnice wynikające ze specyfiki procesów wytwarzania. Dlatego zawsze zalecamy wzięcie pod uwagę poniższych tolerancji.

DŁUGOŚĆ	
	Standardowa tolerancja*
PROFILE	+3 mm
KLOSZE KLIK: 1 m, 2 m, 3 m (poza wymienionymi poniżej)	+5 mm
KLOSZE KLIK: 2 m - C9, D9, E7, E9	+20 mm
KLOSZE KLIK: 4 m	+150 mm
KLOSZE WSUWANE	+20 mm

*Istnieje możliwość przygotowania produktu w zawężonej tolerancji specjalnej. O szczegóły zapytaj opiekuna handlowego. Cięcie produktów wykonywane jest w temperaturze 20°C.

ROZSZERZALNOŚĆ TEMPERATUROWA	
	Wartość podana dla różnicy 10°C, na 1 metr bieżący
PROFILE	do ~0,2 mm
KLOSZE	C10 NARROW: do 0,7 mm
	C10 WIDE: do 0,7 mm
	C10 OPAL: do 0,8 mm
	pozostałe: 0,2~0,3 mm

WYMIARY PRZEKROJÓW
Do wszystkich podawanych wymiarów profili stosowana jest tolerancja zgodnie z Normą PN-EN 755-9.

KOLOR	
POWIERZCHNIE ANODOWANE	srebrny: C-0
	czarny: C-35
POWIERZCHNIE MALOWANE (na podstawie palety RAL)	biały: RAL 9003 mat
	czarny: RAL 9005 mat

Mounting accessories / Akcesoria montażowe

SYSTEM ACCESSORIES - fit many different profiles.

DEDICATED ACCESSORIES - matched to one profile, are usually used for a more precise assembly method: pendant, on an extension arm, at an angle, etc.

AKCESORIA SYSTEMOWE - pasują do wielu różnych profili.

AKCESORIA DEDYKOWANE - dopasowane do jednego profilu, zwykle służą do bardziej sprecyzowanego rodzaju montażu: podwieszanego, na wysięgniku, pod kątem itp.

MOUNTING PLATES, HOLDERS / UCHWYTY

flexible / sprężyste



U flexible mounting plate
uchwyt U sprężysty



cone U flexible mounting plate
uchwyt U sprężysty cone



rack U flexible mounting plate
uchwyt U sprężysty rack

aluminium / aluminiowe



X mounting plate
uchwyt X



T mounting plate
uchwyt T

simple - for perpendicular assembly in a furniture board (cabinets)

proste - do montażu prostokątnego w płycie meblowej (szafki)



SLIM8 simple holder
uchwyt SLIM8 prosty



SURFACE10 simple holder
uchwyt SURFACE10 prosty



WIDE24 simple holder
uchwyt WIDE24 prosty



PEN8 simple holder
uchwyt PEN8 prosty



OVAL20 simple holder
uchwyt OVAL20 prosty

„cone” or „slot”?
„cone” czy „fasolka”?

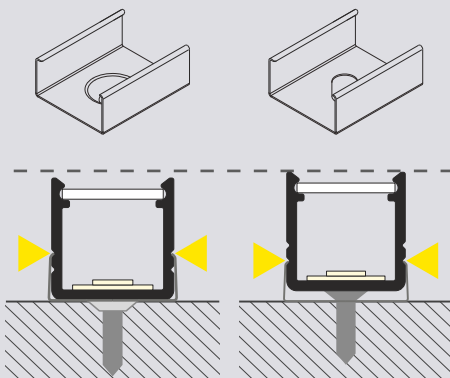

EXTENSION ARMS / WYSIĘGNIKI



OVAL20 double extension arm
wysięgnik OVAL20 podwójny



PEN8 double holder with thread
uchwyt PEN8 podwójny z gwintem



PEN8 jointed holder with soffit ceiling
uchwyt PEN8 przegubowy z podsufitką

CONNECTORS / ŁĄCZNIKI

Easy method of joining 2 profile sections in a straight line or at a defined angle.
Łatwy sposób na łączenie 2 odcinków profili w linii prostej lub pod określonym kątem.



X connector 180 deg
łącznik X 180 st



SURFACE10 connector 90 deg
łącznik SURFACE10 90 st



LINEA20 connectors / łączniki LINEA20:

60°

90°

120°

135°

180°



T connector 180 deg
łącznik T 180 st



GROOVE10 connector 90 deg
łącznik GROOVE10 90 st

LINEA20 bent connectors / łączniki LINEA20 gięte:

90°

270°



CORNER10 connector 90 deg
łącznik CORNER10 90 st

SLINGS / ZAWIESIA

They enable creating pendant luminaires. They are especially recommended for the LED LINEA 20 profile (see pages 2.29-2.40) but are also compatible with most of the profiles.

Umożliwiają tworzenie opraw wiszących. Szczególnie polecane są do profilu LED LINEA20 (patrz str. 2.29-2.40), ale kompatybilne są także z większością profili.

MAX
50 V



SELV sling 50 V 1500
zawiesie SELV 50 V 1500



sling for LED mounting 1500
zawiesie do uchwytu LED 1500

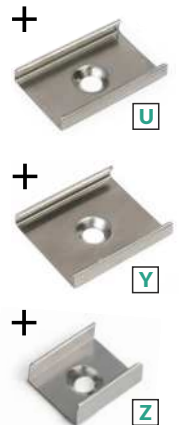

Endings / Zaślepki

The endings, with the aim to aesthetically close the profile and additionally protect the LED source, come in four basic colours: silver, white, black and grey. The endings selected for the profiles for glass are available in transparent colour. Covers endings are available in opal colour. The material used for the production of the endings meets the lighting non-combustibility standard no.: PN-EN 60695-2-11. Material: ABS, PC.

Zaślepki, mające na celu estetyczne domknięcie profilu oraz dodatkową ochronę źródła LED, występują w czterech podstawowych kolorach: srebrnym, białym, czarnym i szarym. Wybrane zaślepki do profili do szkła dostępne są w kolorze transparentnym, a zaślepki do kloszy w wersji mlecznej. Tworzywo użyte do produkcji zaślepek spełnia oświetleniową normę niepalności nr: PN-EN 60695-2-11. Materiał: ABS, PC.

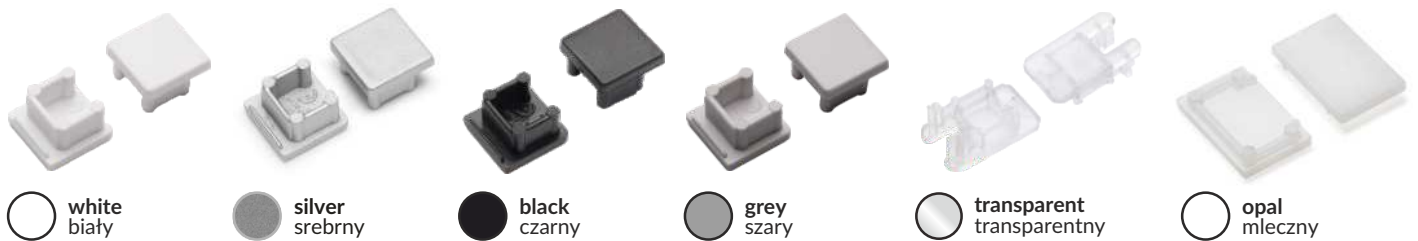

Endings with a hole or without it - which one to choose? Some of our endings come in two versions:
Zaślepki z otworem czy bez - jakie wybrać? Część spośród naszych zaślepek występuje w dwóch wersjach:



With a hole: they allow aesthetic outlet for a cable without the need to drill through the ending or the profile.

Z otworem: pozwalają na estetyczne wyprowadzenie przewodu bez konieczności przewiercania zaślepki lub profilu.



Without a hole: they are an aesthetic and a tighter ending of the profile. Recommended in cases where the appearance is particularly significant, or from the opposite side to the cable outlet.

Bez otworu: stanowią estetyczne i szczelniejsze zakończenie profilu. Zalecane tam, gdzie szczególnie istotny jest wygląd lub od strony przeciwnej niż wyprowadzenie przewodu.

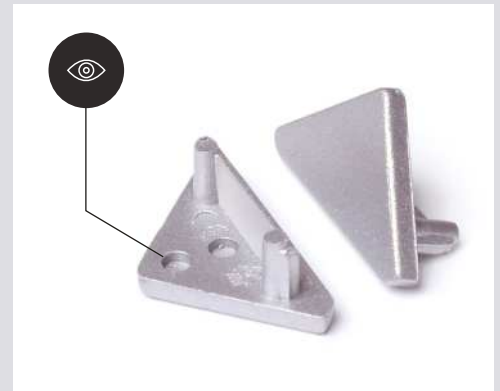

For many products, we offer endings with points to bore a hole. Thanks to this, from one set of endings, it is possible to obtain one ending of each type: with a hole and without one.

Do wielu produktów oferujemy zaślepki z punktami do nawiercenia otworu. Dzięki temu z jednego kompletu zaślepek możliwe jest otrzymanie po jednej zaślepce: z otworem oraz bez otworu.

Markings / Oznaczenia

marking of covers fitting the sockets in the profile

oznaczenia kloszy pasujących do gniazd w profilu

A B C C1 C2 C3 D E E7 F G H I J K

marking of holders fitting the profile

oznaczenia uchwytów pasujących do profilu

S T U U4 U5 U6 U7 W X Y Z

profile with Slick socket

profil z gniazdem Slick



LED profile categories

kategorie profili LED



surface
nawierzchniowy



recessed
wpustowy



corner
kątowy



special application
specjalny



glass application
do szkła

others

inne



maximum LED strip width
maksymalna szerokość taśmy LED



note
uwaga



assembly adhesive
klej montażowy



available in stock
dostępny na magazynie



made in Poland
wyprodukowane w Polsce



EU-registered industrial design
wzory przemysłowe EU

LED accessories / Akcesoria LED

Different LED sources and electronic components can be used for aluminium LED profiles. The correct sequence of connecting individual elements is very important.

Do aluminiowych profili LED można stosować różne źródła LED oraz elektroniczne komponenty. Bardzo istotna jest właściwa kolejność połączenia poszczególnych elementów.

Source / Źródło



We have LED strips with different power, luminous flux and width to choose from. We also have strips available with different light colour temperatures - a few different temperatures of white, as well as RGB and warm-cold (with adjustable light colour temperature). TOPMET offer includes LED strips and modules adapted to 12 V or 24 V voltage. Waterproof sources and components are a special part of the offer.

Depending on the LED selection, you need to match the remaining accessories: cables, connectors, switches, controllers and power supplies.

Some LED sources available on the market may exceed radiation capabilities of a given aluminium profile. In order to ensure correct operation, a LED source with appropriate parameters needs to be matched to an aluminium profile.

LED cable • connectors • distribution box Przewód LED • złączki • konektor



In the case of connecting a few sources to one power supply, you can use a connector for mini-connector with 6 sockets or a LED divider. Our offer also includes cables of different lengths for one colour of LED strips, as well as special ones for RGB strips.

Switch • controller / Włącznik • sterownik



12 V

or / lub

24 V

A lighting fixture set can be enriched with different types of convenient solutions regarding switching, dimming and change of colour. Mechanical switches are available - integrated with the cable or for connecting directly to the LED source, under the cover inside the profile. Turning on is possible both by touch, as well as radio waves - with a remote control via a controller. You can control the colour (with an appropriate light source selected) as well as illuminance.

12 V or 24 V power supply Zasilacz 12 V lub 24 V

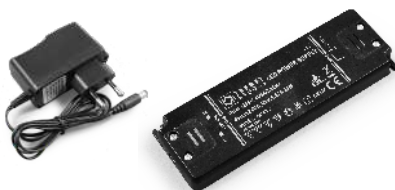

220-240V

The selection of the power supply requires calculation of the power to be consumed by the source, according to the indications of the manufacturer. From the primary side, the current has a voltage of 220-240 V, on the secondary side, to which the LED is connected, the voltage is 12 V or 24 V.

220-240 V cable / Przewód 220-240 V



220-240 V cables, which allow the connection of an entire set to the power supply are also in our offer. A standard cable is 4 m long and a cable with a foot switch - 3.5 m.

More details are available in the LED accessories catalogue (pages: 9.01-9.17).

Do wyboru mamy taśmy LED'owe o różnej mocy, strumieniu świetlnym i szerokości. Dostępne są również taśmy o różnej temperaturze barwowej światła – kilka różnych temperatur bieli, a także RGB oraz ciepła-zimna (z możliwością zmiany temperatury barwowej światła). W ofercie TOPMET dostępne są taśmy oraz moduły LED dostosowane do napięcia 12 V albo 24 V. Specjalną częścią oferty są źródła i komponenty wodoodporne.

Według wybranego źródła LED należy dobierać pozostałe akcesoria: przewody, złączki, włączniki, sterowniki oraz zasilacze.

Niektóre źródła LED dostępne na rynku mogą przekraczać radiacyjne możliwości wybranego profilu aluminiowego. W celu zapewnienia poprawnego działania, należy dobrać do profilu aluminiowego źródło LED o odpowiednich parametrach.

W przypadku podłączenia kilku źródeł do jednego zasilacza, można użyć konektora do mini-złączek z 6 gniazdami lub rozdzielacza LED. Nasza oferta obejmuje także przewody o różnej długości, do jednego koloru taśm LED, a także specjalne do taśm RGB.

Zestaw oświetleniowy można wzbogacić o różnego rodzaju wygodne rozwiązania włączania, ściemniania oraz zmiany koloru. Dostępne są włączniki mechaniczne – zintegrowane z przewodem lub do podłączenia bezpośrednio do źródła LED pod kłosem wewnątrz profilu. Włączanie możliwe jest zarówno przez dotyk, jak i przez fale radiowe – pilotem za pośrednictwem sterownika. Sterować można zarówno barwę (przy wyborze odpowiedniego źródła) oraz natężenie światła.

Dobór zasilacza wymaga przeliczenia mocy, jaką będzie pobierać źródło według wskazań producenta. Od strony pierwotnej prąd ma napięcie 220-240 V, po stronie wtórnej, do której podłączamy LED, napięcie wynosi 12 V lub 24 V.

W naszej ofercie są także przewody 220-240 V pozwalające podłączyć cały zestaw do zasilania. Standardowy przewód ma długość 4 m, przewód z włącznikiem nożnym – 3,5 m.

Więcej szczegółów dostępnych jest w katalogu akcesoriów LED (str.: 9.01-9.17).





2020 LED PROFILES

PROFILE LED

SURFACE / NAWIERZCHNIOWE



SMALL, ALUMINIUM, SURFACE PROFILE

MAŁY, ALUMINIOWY PROFIL NAWIERZCHNIOWY

- universal application
 - Slick socket
 - 2 channels for mounting bracket (with or without wall distance)
 - painted holders
 - maximum LED strip width: 8 mm
-
- uniwersalne zastosowanie
 - gniazdo Slick
 - 2 rowki - 2 poziomy przymocowania uchwytu (z dystansem od ściany lub bez)
 - malowane uchwyty
 - maksymalna szerokość taśmy LED: 8 mm

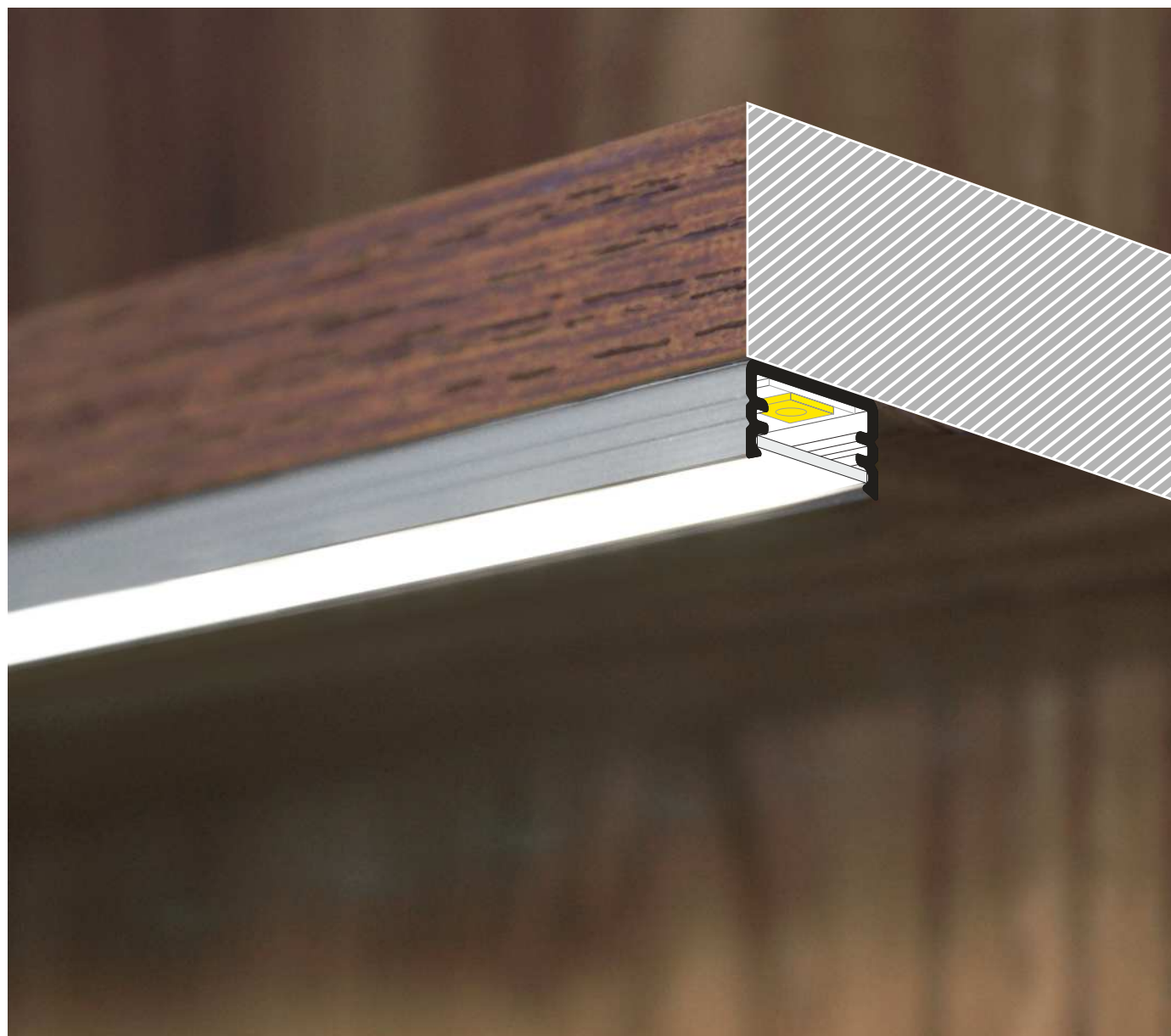

SIMILAR IN THE OFFER / PODOBNE W OFERCIE

SMART10
AC2/Z

SURFACE10
BC/UX

BEGTON12
J/S

SURFACE14
EF/TY



A A slide cover
klosz A wsuwany

C2 C2 click cover
klosz C2 klik

Z¹ Z flexible mounting plate
uchwyt Z sprężysty

Z² cone Z flexible mounting plate
uchwyt Z sprężysty cone

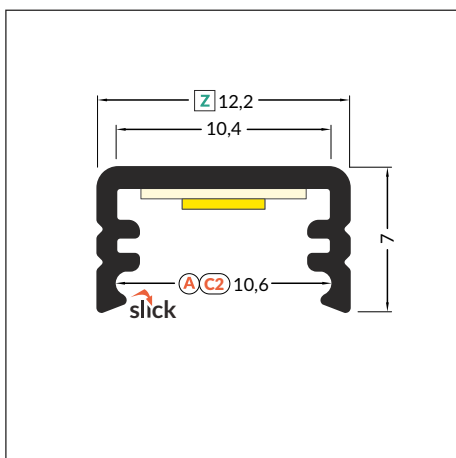
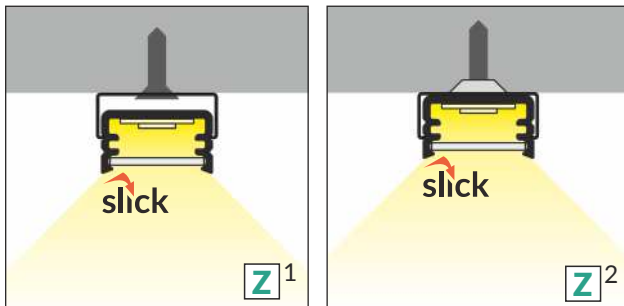
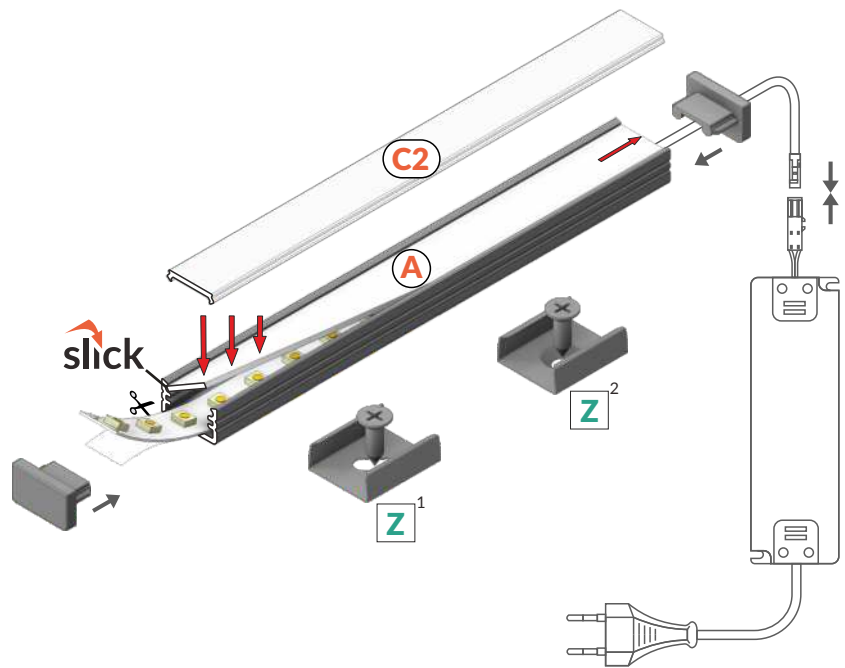

 max 8 mm

 surface
nawierzchniowy



INDEX = 1 pc. length 2000 mm
package > check the pricelist
INDEKS = 1 szt., długość 2000 mm
opakowanie > patrz cennik

white painted
biały malowany
89030001

anodized
anodowany
89030020

black anodized
czarny anodowany
89030021

raw aluminium
surowe aluminium
89030000

Available lengths: 1000 mm, 2000 mm, 3000 mm, 4000 mm.
The standard profile length tolerance is +20 mm.
More details >> 1.08.

Dostępne długości: 1000 mm, 2000 mm, 3000 mm, 4000 mm.
Standardowa tolerancja długości profili wynosi: +20 mm.
Więcej informacji >> 1.08.



COVERS / KLOSZE

A slide cover
colours: transparent, frosted, opal
material: PC, PP, PP

klosz **A** wsuwany
kolory: transparentny, szron, mleczny
materiał: PC, PP, PP



Note! Dimensions of the space to install LED source
Uwaga! Wymiary przestrzeni do zamontowania źródła LED

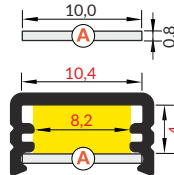

length 2000 mm
package > check the pricelist
długość 2000 mm
opakowanie > patrz cennik

A transparent / A transparentny
index = 10 pcs / indeks = 10 szt.
89070016

A frosted / A szron
index = 10 pcs / indeks = 10 szt.
89070039

A opal / A mleczny
index = 10 pcs / indeks = 10 szt.
89070038

C2 transparent
C2 transparentny
index = 1 pc / indeks = 1 szt.
89000216

C2 opal / C2 mleczny
index = 1 pc / indeks = 1 szt.
89000238

C2 click cover
colours: transparent, opal
material: PMMA

NEW

klosz **C2** klik
kolory: transparentny, mleczny
materiał: PMMA

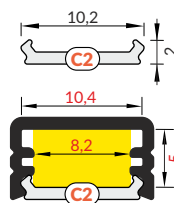

The standard cover length tolerance is +20 mm.
More details >> 1.08.

Standardowa tolerancja długości kloszy wynosi: +20 mm
Więcej informacji >> 1.08.

ENDINGS / ZAŚLEPKI

SLIM8 ending
colours: white, silver, black, grey
material: ABS

zaślepka SLIM8
kolory: biały, srebrny, czarny, szary
materiał: ABS

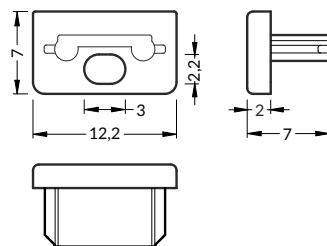

SLIM8 ending with hole
colours: white, silver, black, grey
material: ABS

zaślepka SLIM8 z otworem
kolory: biały, srebrny, czarny, szary
materiał: ABS



INDEX = 10 sets = 20 pcs
package > check the pricelist
INDEKS = 10 kpl = 20 szt.
opakowanie > patrz cennik

white / biały
89080001
silver / srebrny
89080040
black / czarny
89080002
grey / szary
89080022

white / biały
89140001
silver / srebrny
89140040
black / czarny
89140002
grey / szary
89140022

MOUNTINGS / MOCOWANIA

Z flexible mounting plate
colours: white, inox, black
material: stainless steel

uchwyt **Z** sprężysty
kolory: biały, inox, czarny
materiał: stal nierdzewna

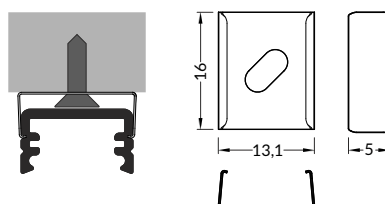

INDEX = 10 sets = 20 pcs
package > check the pricelist
INDEKS = 10 kpl = 20 szt.
opakowanie > patrz cennik

white / biały
89270001

inox
89270019

black / czarny
89270002



MOUNTINGS / MOCOWANIA

cone Z flexible mounting plate
colours: white, inox, black
material: stainless steel

uchwyt Z sprężysty cone
kolory: biały, inox, czarny
materiał: stal nierdzewna

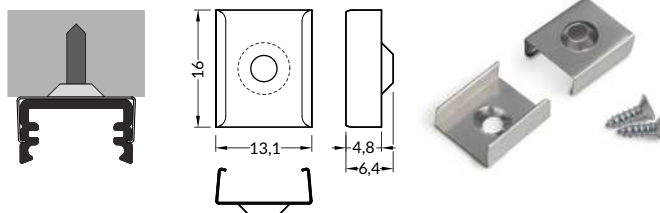

INDEX = 10 sets = 20 pcs
package > check the pricelist
INDEKS = 10 kpl = 20 szt.
opakowanie > patrz cennik

white
biały
89980001

inox
89980019

black
czarny
89980002

SLIM8 simple holder
material: zinc coated steel

uchwyt SLIM8 prosty
materiał: stal ocynkowana

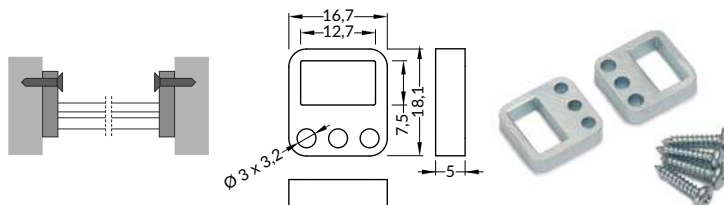

INDEX = 1 set = 2 pcs
package > check the pricelist
INDEKS = 1 kpl = 2 szt.
opakowanie > patrz cennik

zinc coated
stal ocynkowana
89110030

CONNECTORS / ŁĄCZNIKI

SLIM8 connector 90 deg
colours: white, anodized, black
material: aluminium

łącznik SLIM8 90 st
kolory: biały, anodowany, czarny
materiał: aluminium

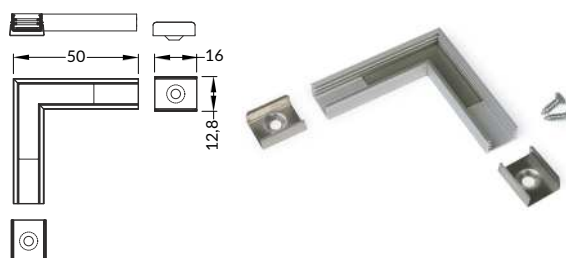

INDEX = 1 set,
package > check the pricelist
INDEKS = 1 kpl.,
opakowanie > patrz cennik

white painted
biały malowany
89150001

anodized
anodowany
89150020

black anodized
czarny anodowany
89150021

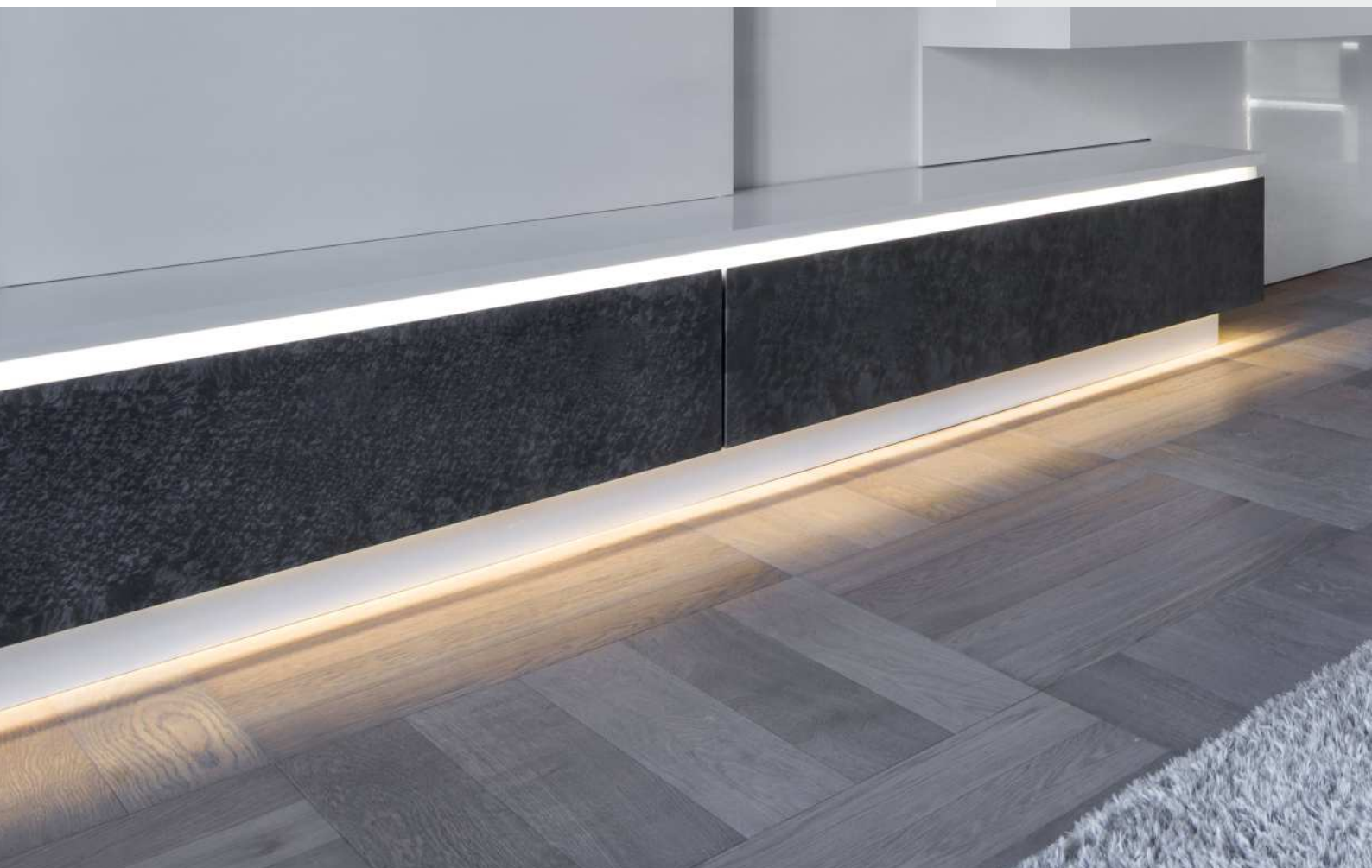

CONTINUOUS LINE OF LIGHT IN A SMALL OVERALL DIMENSIONS

CIĄGŁA LINIA ŚWIATŁA W MAŁYM GABARYCIE

- continuous line of light (when using LED strip 120 P/m and opal cover)
- SLICK socket
- miniature dimensions
- universal application
- the possibility of using waterproof LED strips
- maximum width of LED strip: 10 mm

- ciągła linia światła (przy zastosowaniu taśmy 120 P/m i klosza mlecznego)
- gniazdo SLICK
- miniaturowe gabaryty
- uniwersalne zastosowanie
- możliwość zastosowania taśm wodoodpornych
- maksymalna szerokość taśmy LED: 10 mm



SIMILAR IN THE OFFER / PODOBNE W OFERCIE



SLIM8
AC2/Z



SMART-IN10
AC2/Z



SURFACE10
BC/UX



BEGTON12
J/S



SURFACE14
EF/TY



A A slide cover
klosz A wsuwany

C2 C2 click cover
klosz C2 klik

Z¹ Z flexible mounting plate
uchwyt Z sprężysty

Z² cone Z flexible mounting plate
uchwyt Z sprężysty cone

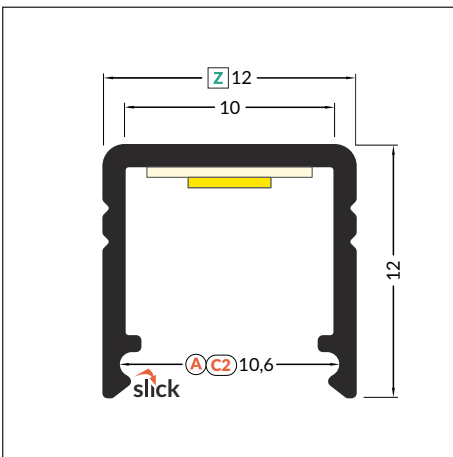
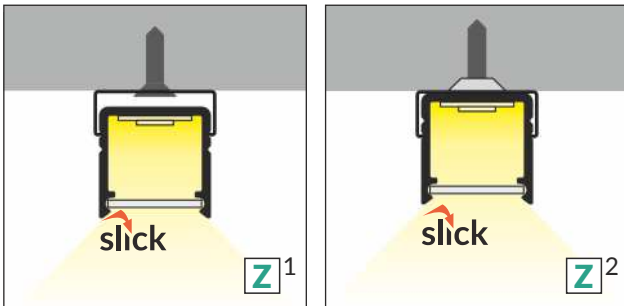
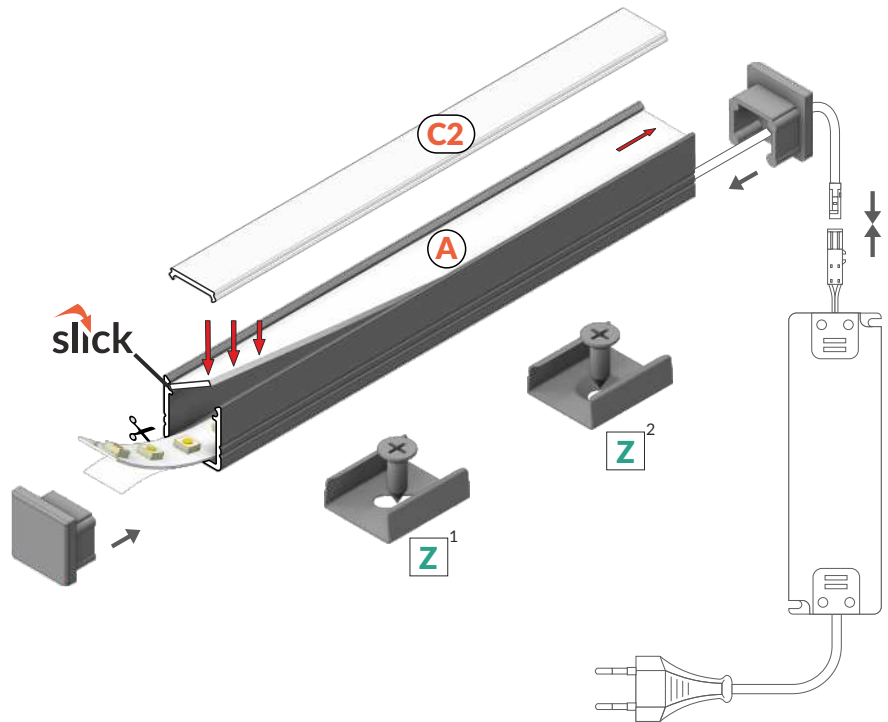

max 10 mm

surface
nawierzchniowy



INDEX = 1 pc. length 2000 mm
package > check the pricelist
INDEKS = 1 szt., długość 2000 mm
opakowanie > patrz cennik

white painted
biały malowany
C2020001



anodized
anodowany
C2020020



black anodized
czarny anodowany
C2020021



raw aluminium
surowe aluminium
C2020000

Available lengths: 1000 mm, 2000 mm, 3000 mm, 4000 mm.
The standard profile length tolerance is +20 mm.
More details >> 1.08.

Dostępne długości: 1000 mm, 2000 mm, 3000 mm, 4000 mm.
Standardowa tolerancja długości profili wynosi: +20 mm.
Więcej informacji >> 1.08.



COVERS / KLOSZE

A slide cover

colours: transparent, frosted, opal
material: PC, PP, PP

klosz A wsuwany
kolory: transparentny, szron, mleczny
materiał: PC, PP, PP

C2 click cover

colours: transparent, opal
material: PMMA

NEW

klosz C2 klik
kolory: transparentny, mleczny
materiał: PMMA



Note! Dimensions of the space to install LED source
Uwaga! Wymiary przestrzeni do zamontowania źródła LED

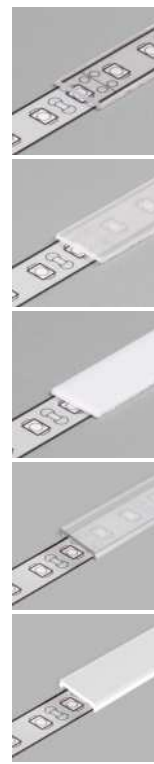
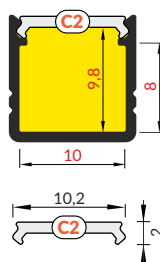
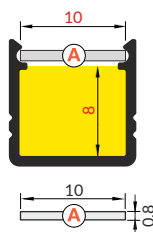

length 2000 mm
package > check the pricelist
długość 2000 mm
opakowanie > patrz cennik

A transparent / A transparentny
index = 10 pcs / indeks = 10 szt.
89070016

A frosted / A szron
index = 10 pcs / indeks = 10 szt.
89070039

A opal / A mleczny
index = 10 pcs / indeks = 10 szt.
89070038

C2 transparent
C2 transparentny
index = 1 pc / indeks = 1 szt.
89000216

C2 opal / C2 mleczny
index = 1 pc / indeks = 1 szt.
89000238

The standard cover length tolerance is +20 mm.
More details >> 1.08.

Standardowa tolerancja długości kloszy wynosi: +20 mm
Więcej informacji >> 1.08.

ENDINGS / ZAŚLEPKI

SMART10 ending

colours: white, silver, black, grey
material: ABS

zaślepka SMART10
kolory: biały, srebrny, czarny, szary
materiał: ABS

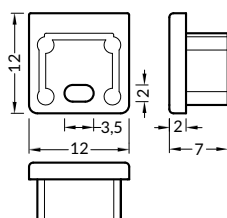

SMART10 ending with hole

colours: white, silver, black, grey
material: ABS

zaślepka SMART10 z otworem
kolory: biały, srebrny, czarny, szary
materiał: ABS

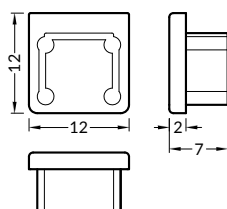

INDEX = 10 sets = 20 pcs
package > check the pricelist
INDEKS = 10 kpl = 20 szt.
opakowanie > patrz cennik

white / biały
C2940001
silver / srebrny
C2940040
black / czarny
C2940002
grey / szary
C2940022

white / biały
C2960001
silver / srebrny
C2960040
black / czarny
C2960002
grey / szary
C2960022

MOUNTINGS / MOCOWANIA

Z flexible mounting plate
colours: white, inox, black
material: stainless steel

uchwyt Z sprężysty
kolory: biały, inox, czarny
materiał: stal nierdzewna

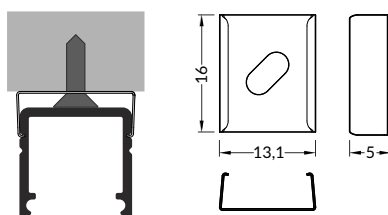

INDEX = 10 sets = 20 pcs
package > check the pricelist
INDEKS = 10 kpl = 20 szt.
opakowanie > patrz cennik

white / biały
89270001
inox
89270019
black / czarny
89270002



MOUNTINGS / MOCOWANIA

cone Z flexible mounting plate
colours: white, inox, black
material: stainless steel

uchwyt Z sprężysty cone
kolory: biały, inox, czarny
materiał: stal nierdzewna

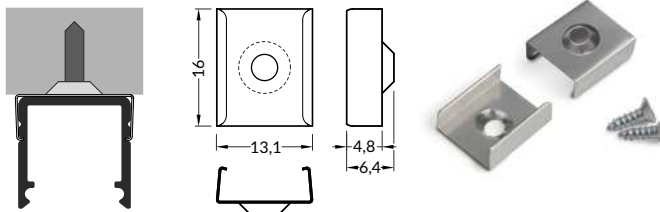

INDEX = 10 sets = 20 pcs
package > check the pricelist
INDEKS = 10 kpl = 20 szt.
opakowanie > patrz cennik

white
biały
89980001

inox
89980019

black
czarny
89980002

CONNECTORS / ŁĄCZNIKI

SMART10 connector 90 deg
colours: white, anodized, black
material: aluminium

łącznik SMART10 90 st
kolory: biały, anodowany, czarny
materiał: aluminium

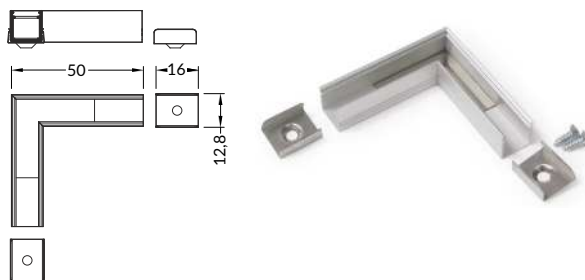

INDEX = 1 set,
package > check the pricelist
INDEKS = 1 kpl.,
opakowanie > patrz cennik

white painted
biały malowany
C2910001

anodized
anodowany
C2910020

black anodized
czarny anodowany
C2910021



SURFACE10 BC/UX

ALUMINIUM SURFACE PROFILE

ALUMINIOWY PROFIL NAWIERZCHNIOWY

- hidden mounting
- wide range of accessories, 6 types of covers
- maximum LED strip width: 10 mm
- ukryte mocowanie
- szeroki wybór akcesoriów, 6 rodzajów kloszy
- maksymalna szerokość taśmy LED: 10 mm

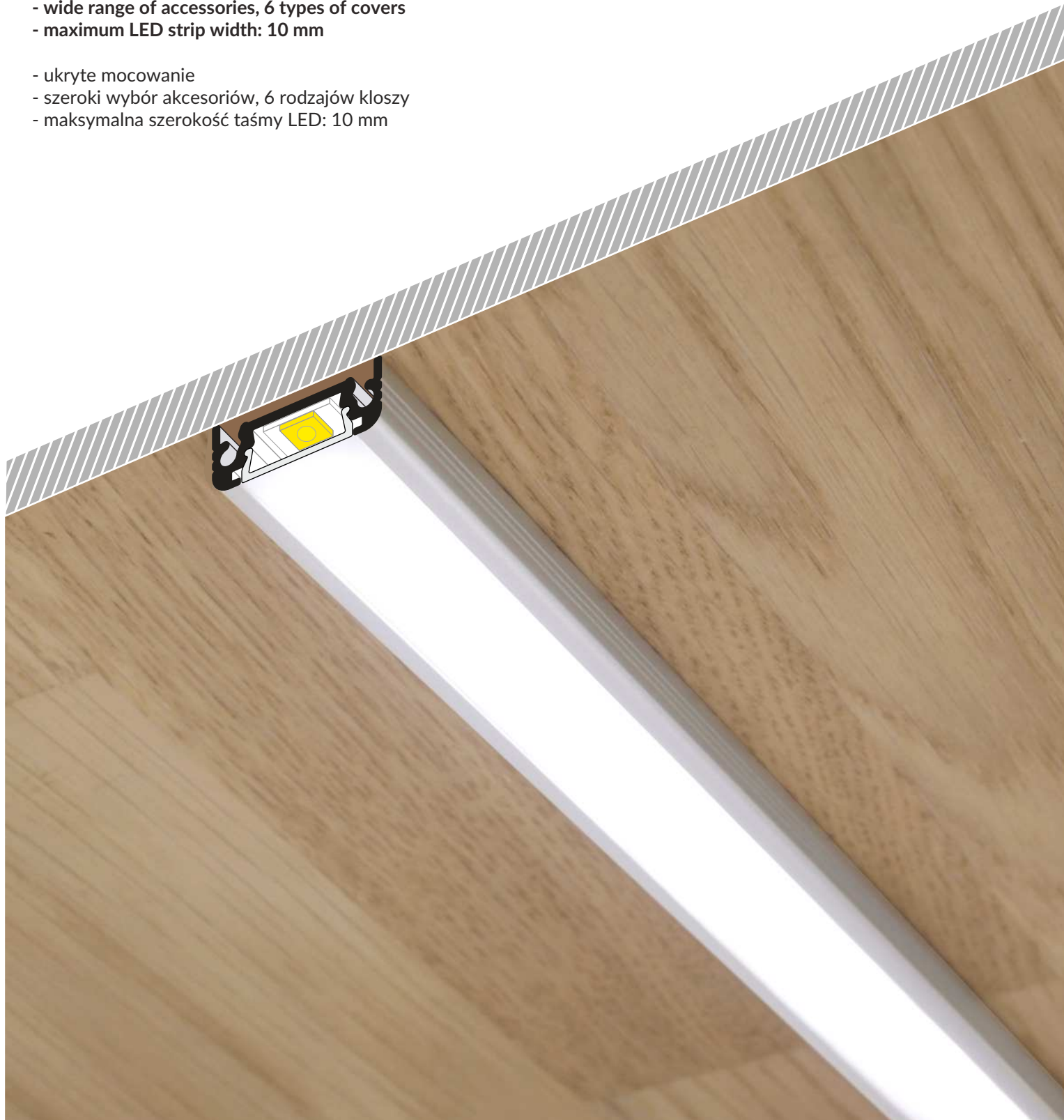

SIMILAR IN THE OFFER / PODOBNE W OFERCIE

SLIM8
AC2/Z

SMART10
AC2/Z

BEGTON12
J/S

SURFACE14
EF/TY

LINEA20
EF/TY

WIDE24
G/W



B slide cover
klosz B wsuwany

C click cover
klosz C klik

C lens cover
klosz C soczewka

U¹ flexible mounting plate
uchwyt U sprężysty

U² cone U flexible mounting plate
uchwyt U sprężysty cone

X¹ mounting plate
uchwyt X

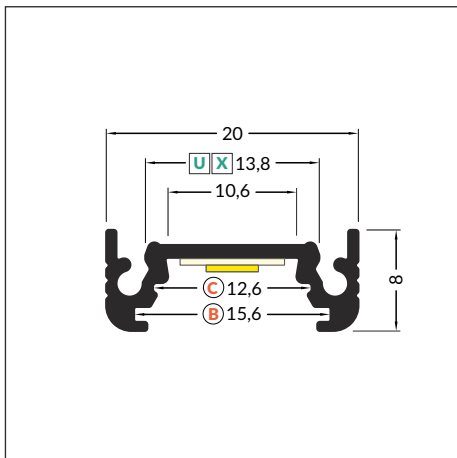
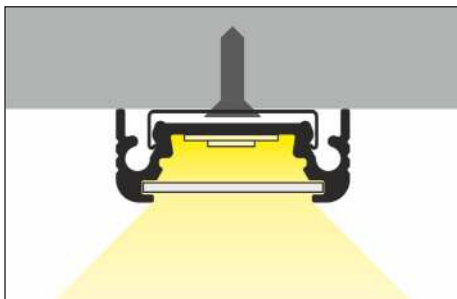
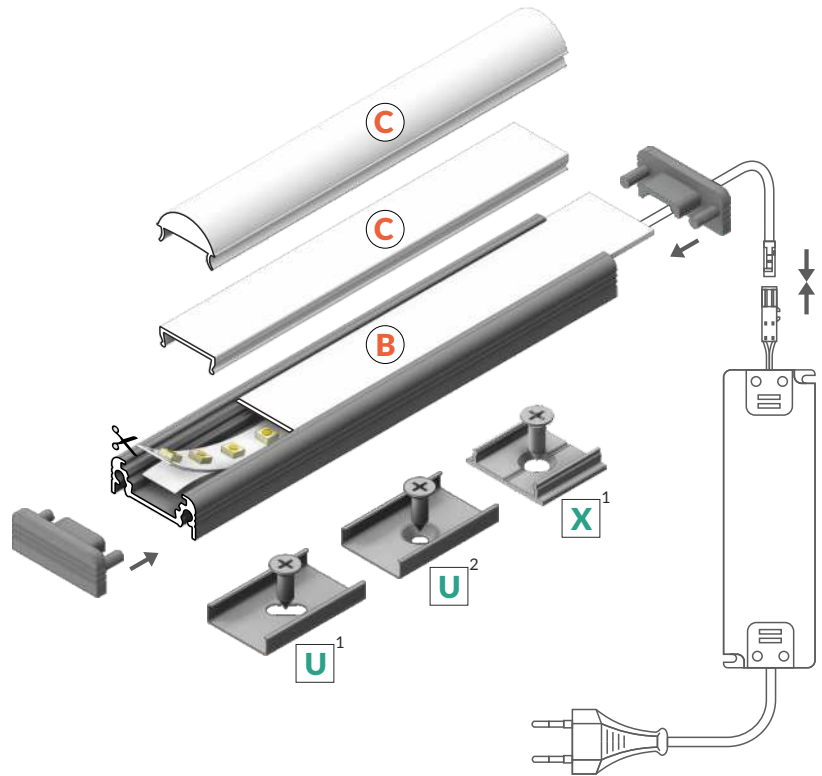

 max 10 mm

 surface
nawierzchniowy



INDEX = 1 pc, length 2000 mm
package > check the pricelist
INDEKS = 1 szt., długość 2000 mm
opakowanie > patrz cennik

white painted
biały malowany
77270001



anodized
anodowany
77270020



black anodized
czarny anodowany
77270021



raw aluminium
surowe aluminium
77270000

Available lengths: 1000 mm, 2000 mm, 3000 mm, 4000 mm.
The standard profile length tolerance is +20 mm.
More details >> 1.08.

Dostępne długości: 1000 mm, 2000 mm, 3000 mm, 4000 mm.
Standardowa tolerancja długości profili wynosi: +20 mm.
Więcej informacji >> 1.08.



COVERS / KLOSZE

B slide cover

colours: transparent, frosted, opal
material: PC, PP, PP

klosz B wsuwany
kolory: transparentny, szron, mleczny
materiał: PC, PP, PP

C click cover

colours: transparent, opal
material: PMMA

klosz C klik
kolory: transparentny, mleczny
materiał: PMMA

C click cover lens
colour: transparent
material: PC

klosz C klik soczewka
kolor: transparentny
materiał: PC



Note! Dimensions of the space to install LED source
Uwaga! Wymiary przestrzeni do zamontowania źródła LED

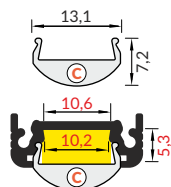
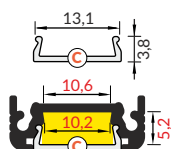
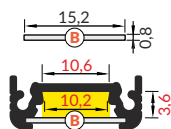

length 2000 mm
package > check the pricelist
długość 2000 mm
opakowanie > patrz cennik

B transparent / B transparentny
index = 10 pcs / indeks = 10 szt.
76250016

B frosted / B szron
index = 10 pcs / indeks = 10 szt.
76250039

B opal / B mleczny
index = 10 pcs / indeks = 10 szt.
76250038

C transparent / C transparentny
index = 1 pc / indeks = 1 szt.
76330000

C opal / C mleczny
index = 1 pc / indeks = 1 szt.
76330038

NEW



reel, length 20 m
package > check the pricelist
rolka, długość 20 m
opakowanie > patrz cennik

C opal / C mleczny
index = 1 pc / indeks = 1 szt.
76360038S



length 2000 mm
package > check the pricelist
długość 2000 mm
opakowanie > patrz cennik

C lens / C soczewka
index = 1 pc / indeks = 1 szt.
76300000

The standard cover length tolerance is +20 mm.
More details >> 1.08.
Standardowa tolerancja długości kloszy wynosi: +20 mm
Więcej informacji >> 1.08.

MOUNTINGS / MOCOWANIA

U flexible mounting plate

colours: inox
material: stainless steel

uchwyt U sprężysty
kolory: inox
materiał: stal nierdzewna

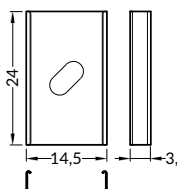
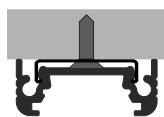

cone U flexible mounting plate

colours: inox
material: stainless steel

uchwyt U sprężysty cone
kolory: inox
materiał: stal nierdzewna

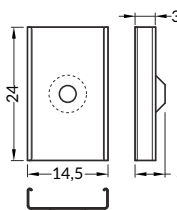
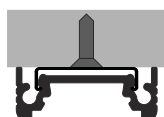

X mounting plate

colours: raw aluminium
material: aluminium

uchwyt X
kolory: surowe aluminium
materiał: aluminium

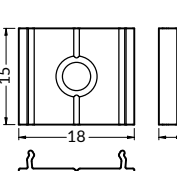
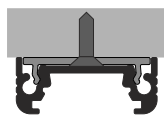

INDEX = 10 sets = 20 pcs
package > check the pricelist
INDEKS = 10 kpl = 20 szt.
opakowanie > patrz cennik

inox
76380000

inox
76620000

raw aluminium
surowe aluminium
76260000



SURFACE10 simple holder

material: zinc coated
uchwyt SURFACE10 prosty
material: stal ocynkowana

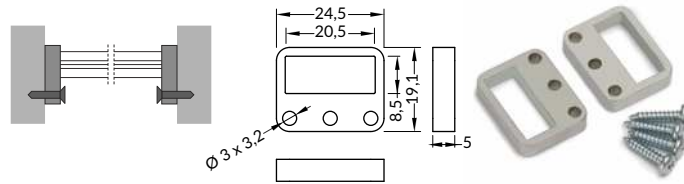

INDEX = 1 set = 2 pcs
package > check the pricelist
INDEKS = 1 kpl = 2 szt.
opakowanie > patrz cennik

zinc coated
stal ocynkowana
77370030

ENDINGS / ZAŚLEPKI

SURFACE10 ending gen2

colours: white, silver, black, grey
material: ABS

zaślepka SURFACE10 gen2
kolory: biały, srebrny, czarny, szary
material: ABS

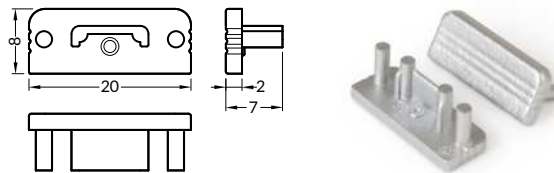

INDEX = 10 sets = 20 pcs
package > check the pricelist
INDEKS = 10 kpl = 20 szt.
opakowanie > patrz cennik

white / biały
77990001
silver / srebrny
77990040
black / czarny
77990002
grey / szary
77990022

SURFACE10 ending gen2 with hole

colours: white, silver, black, grey
material: ABS

zaślepka SURFACE10 gen2 z otworem
kolory: biały, srebrny, czarny, szary
material: ABS

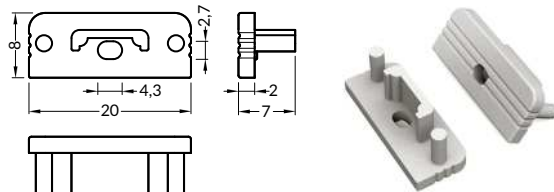

white / biały
77980001
silver / srebrny
77980040
black / czarny
77980002
grey / szary
77980022

CONNECTORS / ŁĄCZNIKI

X connector 180 deg

colour: inox
material: aluminium

łącznik X 180 st
kolor: inox
material: aluminium

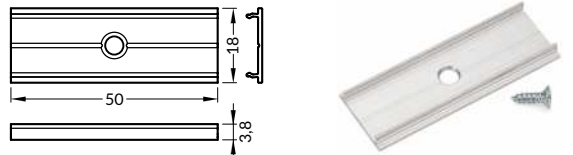

INDEX = 1 set,
package > check the pricelist
INDEKS = 1 kpl.,
opakowanie > patrz cennik

raw aluminium
surowe aluminium
76350000

SURFACE10 connector 90 deg

colours: white, anodized, black
material: aluminium

łącznik SURFACE10 90 st
kolory: biały, anodowany, czarny
material: aluminium

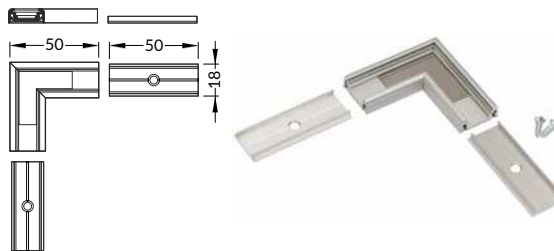

white painted
biały malowany
77410001

anodized
anodowany
77410020

black anodized
czarny anodowany
77410021



BEGTON12 J/S



SMALL SURFACE ALUMINIUM PROFILE

MAŁY ALUMINIOWY PROFIL NAWIERZCHNIOWY

- light weight, budget profile
- Slick socket
- maximum LED strip width: 12 mm

- lekki profil budżetowy
- gniazdo z funkcją Slick
- maksymalna szerokość taśmy LED: 12 mm



SIMILAR IN THE OFFER / PODOBNE W OFERCIE



SLIM8
AC2/Z



SMART10
AC2/Z



SURFACE10
BC/UX



BEGTIN12
J/S



SURFACE14
EF/TY



- J** slide cover
klosz J wsuwany
- C** click cover
klosz C klik
- C*** BEGTON12 C ending for C click cover
zaślepka BEGTON12 C do klosza C klik
- S¹** flexible mounting plate
uchwyt S sprężysty
- S²** cone S flexible mounting plate
uchwyt S sprężysty cone

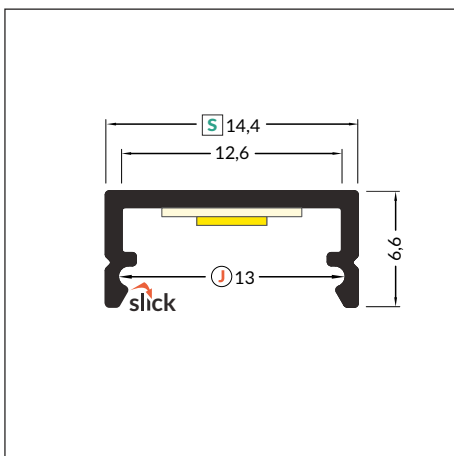
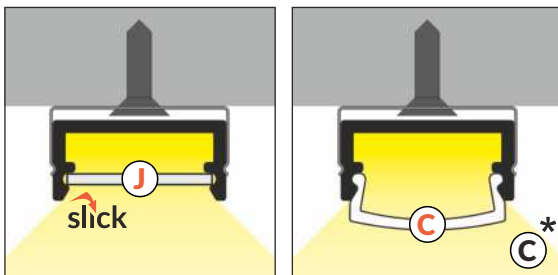
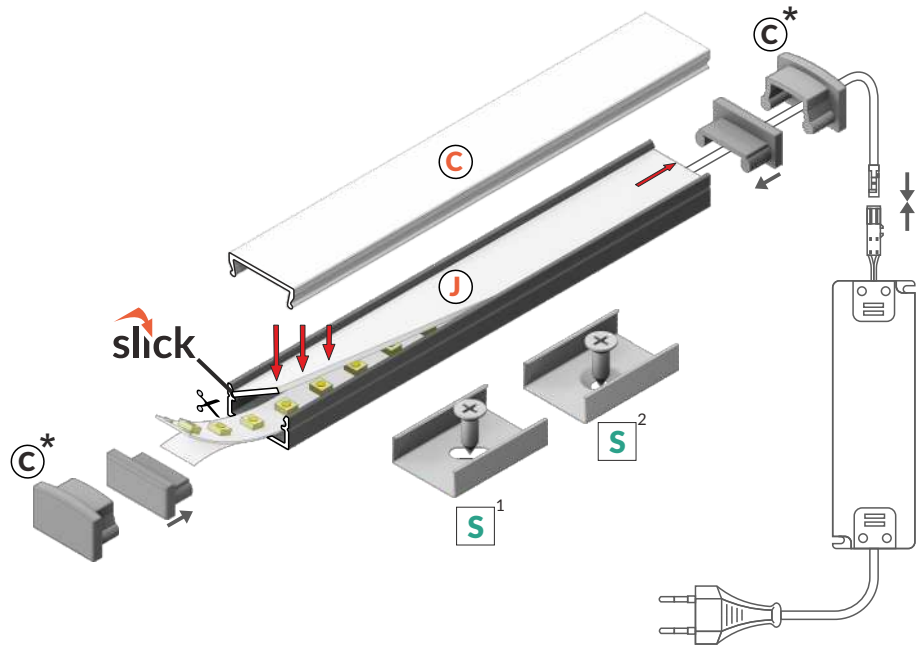

max 12 mm



surface
nawierzchniowy



INDEX = 1 pc, length 2000 mm
package > check the pricelist
INDEKS = 1 szt., długość 2000 mm
opakowanie > patrz cennik

white painted
biały malowany
C7020001



anodized
anodowany
C7020020



black anodized
czarny anodowany
C7020021



raw aluminium
surowe aluminium
C7020000

Available lengths: 1000 mm, 2000 mm, 3000 mm, 4000 mm.
The standard profile length tolerance is +20 mm.
More details >> 1.08.

Dostępne długości: 1000 mm, 2000 mm, 3000 mm, 4000 mm.
Standardowa tolerancja długości profili wynosi: +20 mm.
Więcej informacji >> 1.08.



COVERS / KLOSZE

J slide cover

colours: transparent, frosted, opal
material: PC, PP, PP

klosz J wsuwany
kolory: transparentny, szron, mleczny
materiał: PC, PP, PP



Note! Dimensions of the space to install LED source
Uwaga! Wymiary przestrzeni do zamontowania źródła LED

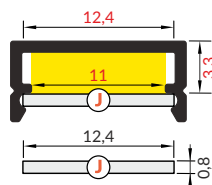

length 2000 mm
package > check the pricelist
długość 2000 mm
opakowanie > patrz cennik

J transparent / J transparentny
index = 10 pcs / indeks = 10 szt.

70330016

J frosted / J szron
index = 10 pcs / indeks = 10 szt.

70330039

J opal / J mleczny
index = 10 pcs / indeks = 10 szt.

70330038

The standard cover length tolerance is +20 mm.
More details >> 1.08.

Standardowa tolerancja długości kloszy wynosi: +20 mm
Więcej informacji >> 1.08.

ENDINGS / ZAŚLEPKI

BEGTON12 ending

colours: white, silver, black, grey
material: ABS

zaślepka BEGTON12
kolory: biały, srebrny, czarny, szary
materiał: ABS

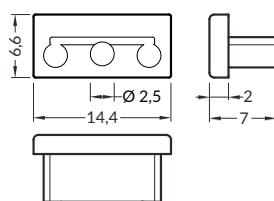

Ending with marked space to bore the holes.
Zaślepka z punktami do przewiercenia otworów.



BEGTON12 C ending

colours: white, silver, black, grey
material: ABS

zaślepka BEGTON12 C
kolory: biały, srebrny, czarny, szary
materiał: ABS

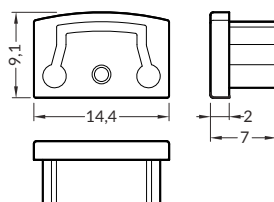

INDEX = 10 sets = 20 pcs
package > check the pricelist
INDEKS = 10 kpl = 20 szt.
opakowanie > patrz cennik

white / biały
C7960001

silver / srebrny
C7960040

black / czarny
C7960002

grey / szary
C7960022

white / biały
C7940001

silver / srebrny
C7940040

black / czarny
C7940002

grey / szary
C7940022

MOUNTINGS / MOCOWANIA

S flexible mounting plate
colours: white, inox, black
material: stainless steel

uchwyt S sprężysty
kolory: biały, inox, czarny
materiał: stal nierdzewna

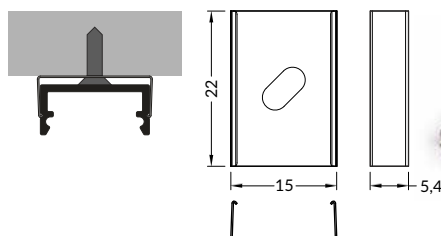

INDEX = 10 sets = 20 pcs
package > check the pricelist
INDEKS = 10 kpl = 20 szt.
opakowanie > patrz cennik

white / biały
C7980001

inox
C7980019

black / czarny
C7980002

cone S flexible mounting plate
colours: white, inox, black
material: stainless steel

uchwyt S sprężysty cone
kolory: biały, inox, czarny
materiał: stal nierdzewna

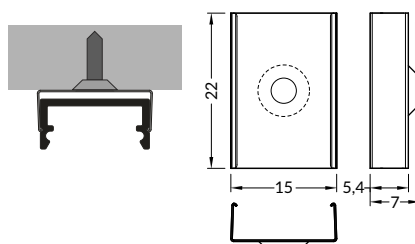

white / biały
C7950001

inox
C7950019

black / czarny
C7950002



UNI12 BCD/U

SURFACE AND RECESSED PROFILE

PROFIL WPUSTOWO-NAWIERZCHNIOWY

- 7 diffusers to choose from
- increased radiation – it is possible to use a stronger LED strip
- maximum LED strip width: 12 mm

- 7 kloszy do wyboru
- zwiększona radiacja – możliwość zastosowania mocniejszej taśmy LED
- maksymalna szerokość taśmy LED: 12 mm



SIMILAR IN THE OFFER / PODOBNE W OFERCIE





B slide cover
klosz B wsuwany

C click cover
klosz C klik

C lens cover
klosz C soczewka

D click cover
klosz D klik

U¹ flexible mounting plate
uchwyt U sprężysty

U² cone U flexible mounting plate
uchwyt U sprężysty cone

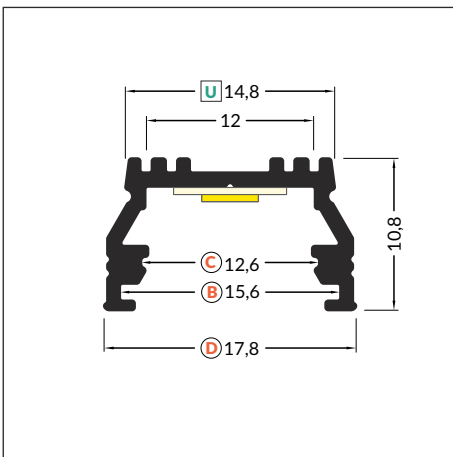
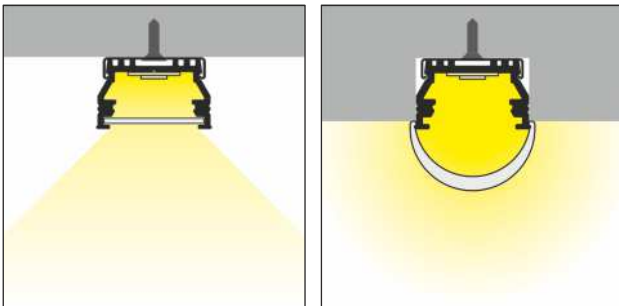
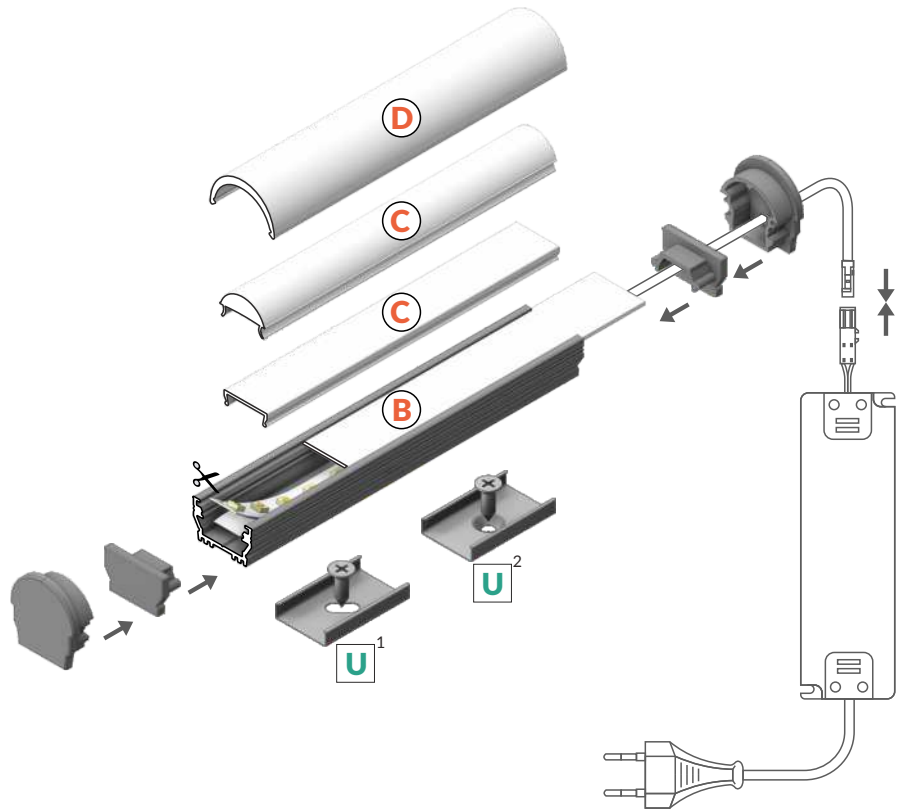

INDEX = 1 pc. length 2000 mm
package > check the pricelist
INDEKS = 1 szt., długość 2000 mm
opakowanie > patrz cennik

white painted
biały malowany
A1020001

anodized
anodowany
A1020020

black anodized
czarny anodowany
A1020021

raw aluminium
surowe aluminium
A1020000

Available lengths: 1000 mm, 2000 mm, 3000 mm, 4000 mm.
The standard profile length tolerance is +20 mm.
More details >> 1.08.

Dostępne długości: 1000 mm, 2000 mm, 3000 mm, 4000 mm.
Standardowa tolerancja długości profilu wynosi: +20 mm.
Więcej informacji >> 1.08.



COVERS / KLOSZE

B slide cover

colours: transparent, frosted, opal
material: PC, PP, PP

klosz B wsuwany
kolory: transparentny, szron, mleczny
materiał: PC, PP, PP



Note! Dimensions of the space to install LED source
Uwaga! Wymiary przestrzeni do zamontowania źródła LED

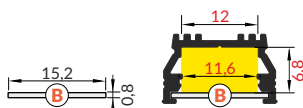

C click cover

colours: transparent, opal
material: PMMA

klosz C klik
kolory: transparentny, mleczny
materiał: PMMA

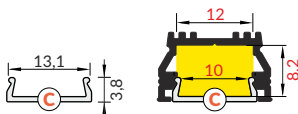

C lens click cover

colour: transparent
material: PC

klosz C klik soczewka
kolor: transparentny
materiał: PC

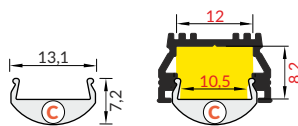

D click cover

colour: opal
material: PMMA

klosz D klik
kolor: mleczny
materiał: PMMA

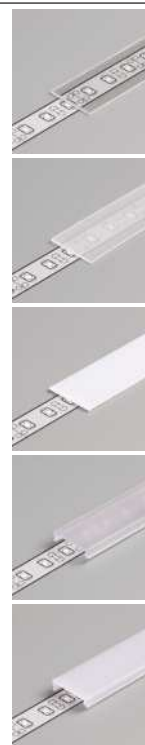
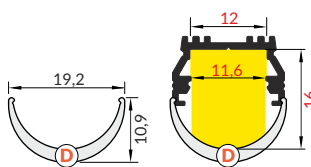

length 2000 mm
package > check the pricelist
długość 2000 mm
opakowanie > patrz cennik

B transparent / B transparentny
index = 10 pcs / indeks = 10 szt.
76250016

B frosted / B szron
index = 10 pcs / indeks = 10 szt.
76250039

B opal / B mleczny
index = 10 pcs / indeks = 10 szt.
76250038

C transparent / C transparentny
index = 1 pc / indeks = 1 szt.
76330000

C opal / C mleczny
index = 1 pc / indeks = 1 szt.
76330038

NEW



reel, length 20 m
package > check the pricelist
rolka, długość 20 m
opakowanie > patrz cennik

C opal / C mleczny
index = 1 pc / indeks = 1 szt.
76360038S



length 2000 mm
package > check the pricelist
długość 2000 mm
opakowanie > patrz cennik

C lens / C soczewka
index = 1 pc / indeks = 1 szt.
76300000

D opal / D mleczny
index = 1 pc / indeks = 1 szt.
A1140038

The standard cover length tolerance is +20 mm.
More details >> 1.08.

Standardowa tolerancja długości kloszy wynosi: +20 mm
Więcej informacji >> 1.08.

MOUNTINGS / MOCOWANIA

U flexible mounting plate

colour: inox
material: stainless steel

uchwyt U sprężysty
kolor: inox
materiał: stal nierdzewna

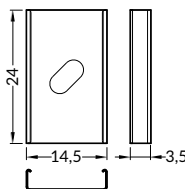
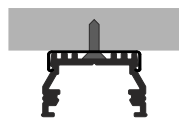

INDEX = 10 sets = 20 pcs
package > check the pricelist
INDEKS = 10 kpl = 20 szt.
opakowanie > patrz cennik

inox
76380000

cone U flexible mounting plate

colour: inox
material: stainless steel

uchwyt U sprężysty cone
kolor: inox
materiał: stal nierdzewna

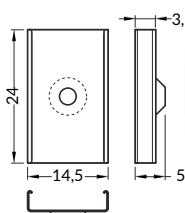
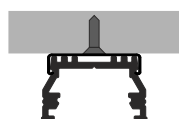

inox
76620000



CONNECTORS / ŁĄCZNIKI

UNI12 connector 90 deg
colours: white, anodized, black
material: aluminium

łącznik UNI12 90 st
kolory: biały, anodowany, czarny
materiał: aluminium

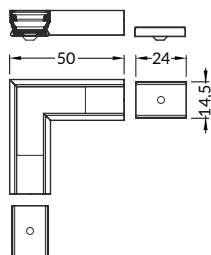

INDEX = 1 set, package > check the pricelist
INDEKS = 1 kpl., opakowanie > patrz cennik

white painted
biały malowany
A1910001
anodized
anodowany
A1910020
black anodized
czarny anodowany
A1910021

ENDINGS / ZAŚLEPKI

UNI12 ending gen2
colours: white, silver, black, grey
material: ABS

zaślepka UNI12 gen2
kolory: biały, srebrny, czarny, szary
materiał: ABS

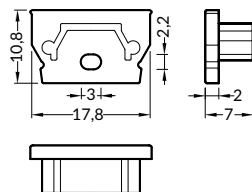

INDEX = 10 sets = 20 pcs
package > check the pricelist
INDEKS = 10 kpl = 20 szt.
opakowanie > patrz cennik

white / biały
A1900001
silver / srebrny
A1900040
black / czarny
A1900002
grey / szary
A1900022

UNI12 ending gen2 with hole
colours: white, silver, black, grey
material: ABS

zaślepka UNI12 gen2 z otworem
kolory: biały, srebrny, czarny, szary
materiał: ABS



white / biały
A1890001
silver / srebrny
A1890040
black / czarny
A1890002
grey / szary
A1890022

UNI12 D ending
colours: white, silver, black, grey
material: ABS

zaślepka UNI12 D
kolory: biały, srebrny, czarny, szary
materiał: ABS

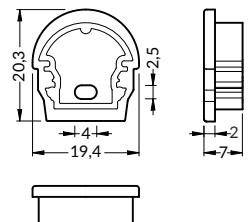

white / biały
A1940001
silver / srebrny
A1940040
black / czarny
A1940002
grey / szary
A1940022

UNI12 D ending with hole
colours: white, silver, black, grey
material: ABS

zaślepka UNI12 D z otworem
kolory: biały, srebrny, czarny, szary
materiał: ABS



white / biały
A1960001
silver / srebrny
A1960040
black / czarny
A1960002
grey / szary
A1960022



SURFACE14 EF/TY

ALUMINIUM SURFACE PROFILE

ALUMINIOWY PROFIL NAWIERZCHNIOWY

- hidden mounting
- maximum LED strip width: 14 mm
- ukryte mocowanie
- maksymalna szerokość taśmy LED: 14 mm

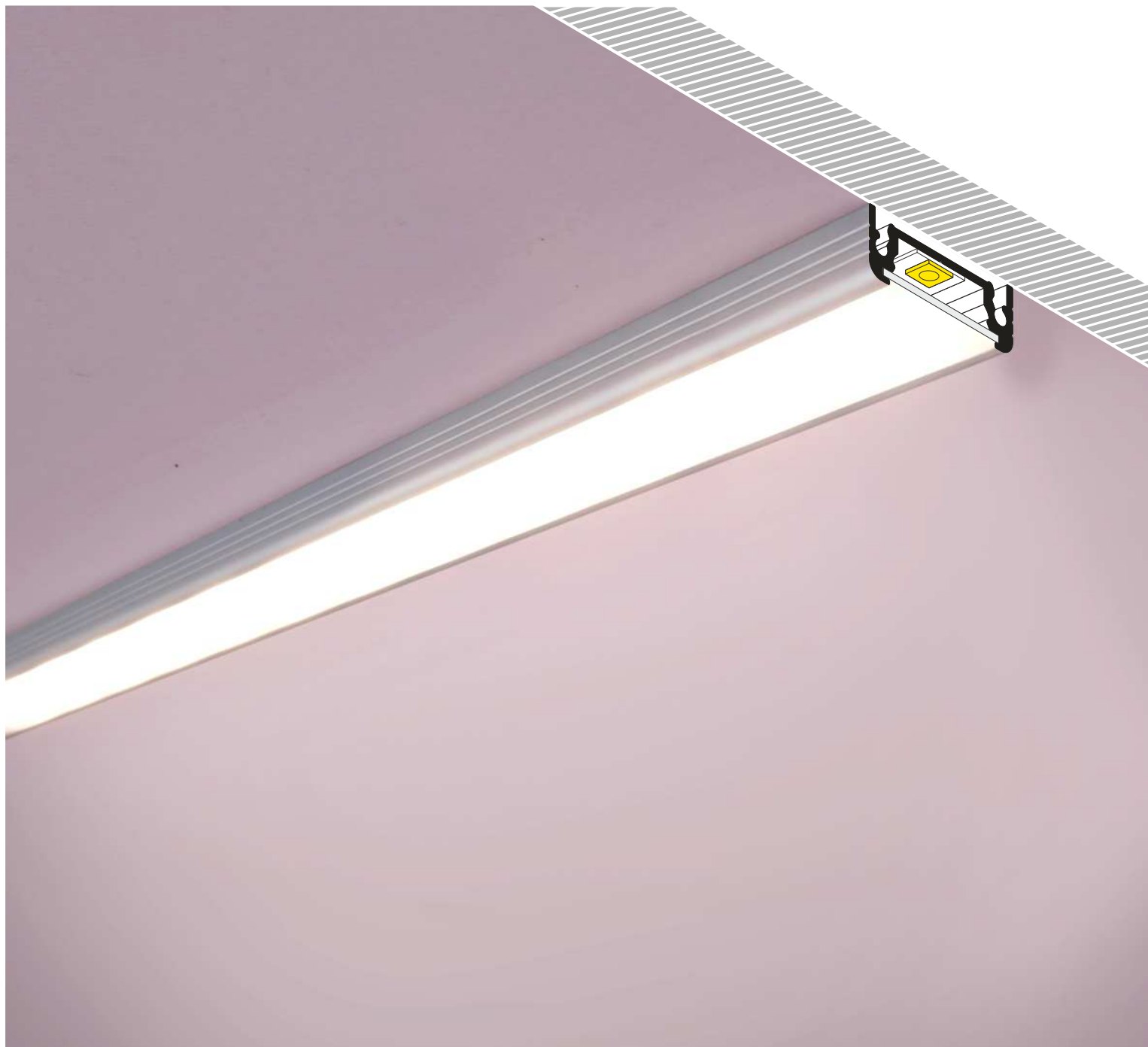

SIMILAR IN THE OFFER / PODOBNE W OFERCIE



SLIM8
AC2/Z



SMART10
AC2/Z



SURFACE10
BC/UX



LINEA20
EF/TY



WIDE24
G/W



E slide cover
klosz E wsuwany

F click cover
klosz F klik

E7 click cover
klosz E7 klik

Y¹ Y flexible mounting plate
uchwyt Y sprężysty

Y² cone Y flexible mounting plate
uchwyt Y sprężysty cone

T mounting plate
uchwyt T

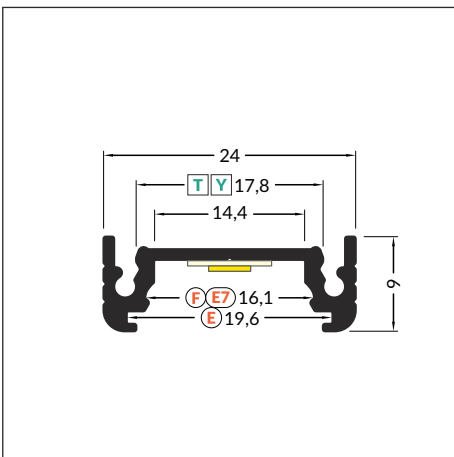
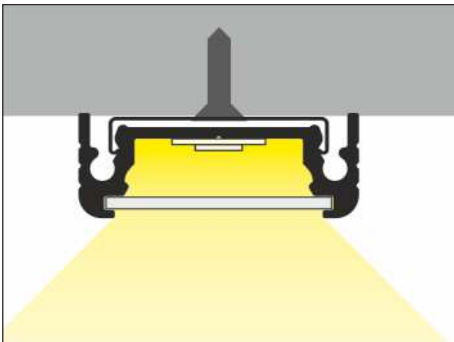
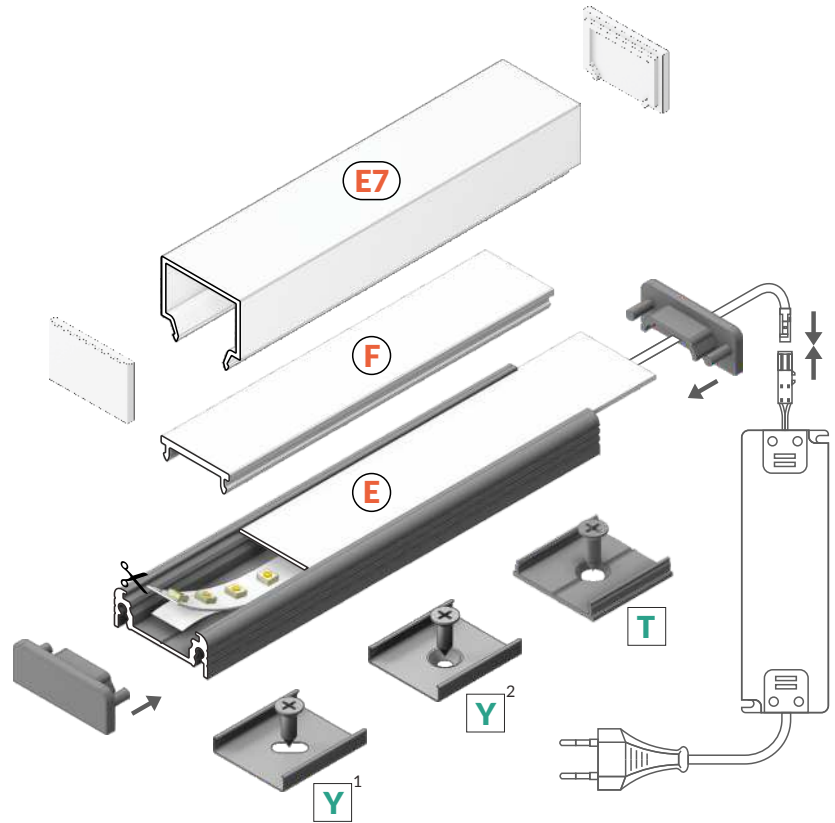

 max 14 mm

 surface
nawierzchniowy



INDEX = 1 pc, length 2000 mm
package > check the price list
INDEKS = 1 szt., długość 2000 mm
opakowanie > patrz cennik

white painted
biały malowany
A2020001



anodized
anodowany
A2020020



black anodized
czarny anodowany
A2020021



raw aluminium
surowe aluminium
A2020000

Available lengths: 1000 mm, 2000 mm, 3000 mm, 4000 mm.
The standard profile length tolerance is +20 mm.
More details >> 1.08.

Dostępne długości: 1000 mm, 2000 mm, 3000 mm, 4000 mm.
Standardowa tolerancja długości profilu wynosi: +20 mm.
Więcej informacji >> 1.08.



COVERS / KLOSZE

E slide cover

colours: transparent, frosted, opal
material: PC, PP, PP

klosz E wsuwany
kolory: transparentny, szron, mleczny
materiał: PC, PP, PP



Note! Dimensions of the space to install LED source
Uwaga! Wymiary przestrzeni do zamontowania źródła LED

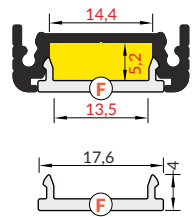
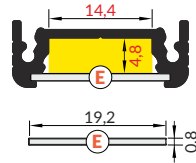

F click cover

colours: transparent, opal
material: PMMA

klosz F klik
kolory: transparentny, mleczny
materiał: PMMA

E7 click cover

colour: opal
material: PMMA

klosz E7 klik
kolor: mleczny
materiał: PMMA

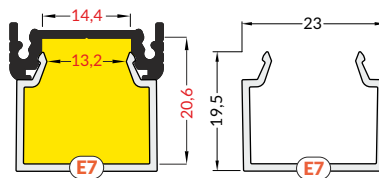

NEW

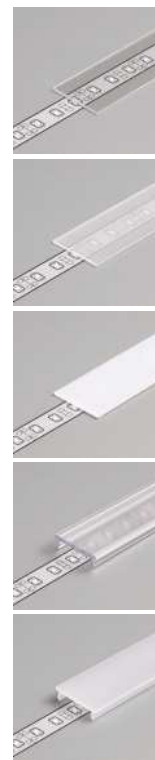
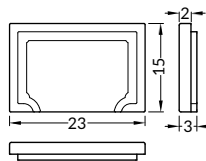

length 2000 mm
package > check the pricelist
długość 2000 mm
opakowanie > patrz cennik

E transparent / E transparentny
index = 10 pcs / indeks = 10 szt.

A2040016

E frosted / E szron
index = 10 pcs / indeks = 10 szt.

A2040039

E opal / E mleczny
index = 10 pcs / indeks = 10 szt.

A2040038

F transparent / F transparentny
index = 1 pc / indeks = 1 szt.

A2060016

F opal / F mleczny
index = 1 pc / indeks = 1 szt.

A2060038

reel, length 20 m
package > check the pricelist
rolka, długość 20 m
opakowanie > patrz cennik

F opal / F mleczny
index = 1 pc / indeks = 1 szt.

A2210038S

length 2000 mm
package > check the pricelist
długość 2000 mm
opakowanie > patrz cennik

E7 opal / E7 mleczny
index = 1 pc / indeks = 1 szt.

C1080038

The standard cover length tolerance is +20 mm.
More details >> 1.08.

Standardowa tolerancja długości kloszy wynosi: +20 mm
Więcej informacji >> 1.08.

INDEX = 1 set = 2 pcs
package > check the pricelist
INDEKS = 1 kpl = 2 szt.
opakowanie > patrz cennik

E7 opal ending
zaślepka E7 mleczny

C1840038

MOUNTINGS / MOCOWANIA

Y flexible mounting plate

colour: inox
material: stainless steel

uchwyt Y sprężysty
kolor: inox
materiał: stal nierdzewna

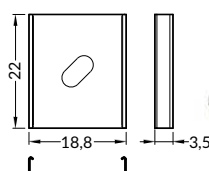
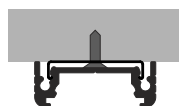

INDEX = 10 sets = 20 pcs
package > check the pricelist
INDEKS = 10 kpl = 20 szt.
opakowanie > patrz cennik

inox
A2090019

cone Y flexible mounting plate

colour: inox
material: stainless steel

uchwyt Y sprężysty cone
kolor: inox
materiał: stal nierdzewna

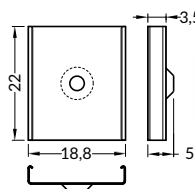
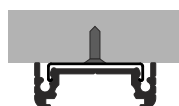

inox
A2130019



MOUNTINGS / MOCOWANIA

T mounting plate
colour: raw aluminium
material: aluminium

uchwyt **T**
kolor: surowe aluminium
materiał: aluminium

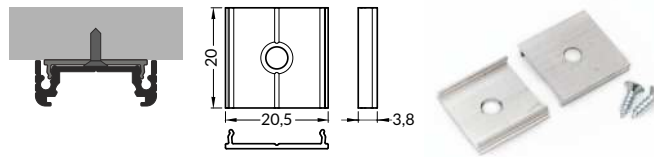

INDEX = 10 sets = 20 pcs
package > check the pricelist
INDEKS = 10 kpl = 20 szt.
opakowanie > patrz cennik

raw aluminium
surowe aluminium
C6960000

ENDINGS / ZAŚLEPKI

SURFACE14 ending gen2
colours: white, silver, black, grey
material: ABS

zaślepka SURFACE14 gen2
kolory: biały, srebrny, czarny, szary
materiał: ABS

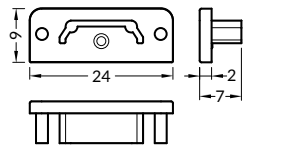

INDEX = 10 sets = 20 pcs
package > check the pricelist
INDEKS = 10 kpl = 20 szt.
opakowanie > patrz cennik

white / biały
A2980001
silver / srebrny
A2980040
black / czarny
A2980002
grey / szary
A2980022

SURFACE14 ending gen2 with hole
colours: white, silver, black, grey
material: ABS

zaślepka SURFACE14 gen2 z otworem
kolory: biały, srebrny, czarny, szary
materiał: ABS

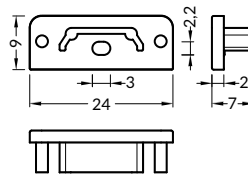

white / biały
A2970001
silver / srebrny
A2970040
black / czarny
A2970002
grey / szary
A2970022

CONNECTORS / ŁĄCZNIKI

T connector 180 deg
colour: raw aluminium
material: aluminium

łącznik **T** 180 st
kolor: surowe aluminium
materiał: aluminium

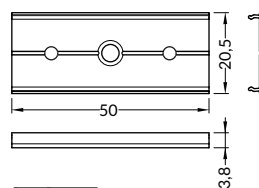

INDEX = 1 set, package > check the pricelist
INDEKS = 1 kpl, opakowanie > patrz cennik

raw aluminium
surowe aluminium
C6990000

SURFACE14 connector 90 deg
colours: white, anodized, black
material: aluminium

łącznik SURFACE14 90 st
kolory: biały, anodowany, czarny
materiał: aluminium

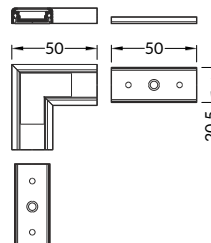

white painted / biały malowany
A2990001

anodized / anodowany
A2990020

black anodized
czarny anodowany
A2990021



SMART16 BC3/U4



ECONOMICAL PROFILE FOR 16 mm LED STRIP

EKONOMICZNY PROFIL DO TAŚM 16 mm

- SLICK socket - easy assembly technology
- 2 channels for mounting bracket (with or without mounting surface distance)
- continuous line of light (when using LED strip 120 P/m and opal cover)
- maximum width of LED strip: 16 mm
- gniazdo SLICK - prosty montaż klosza
- 2 rowki - 2 poziomy przymocowania uchwyty (z dystansem od płaszczyzny montażowej lub bez)
- ciągła linia światła (przy zastosowaniu taśmy 120 P/m i klosza mlecznego)
- maksymalna szerokość taśmy LED: 16 mm



SIMILAR IN THE OFFER / PODOBNE W OFERCIE





B slide cover
klosz B wsuwany

C3 click cover
klosz C3 klik

U4¹ U4 mounting plate
uchwyt U4

U4² cone U4 mounting plate
uchwyt U4 cone

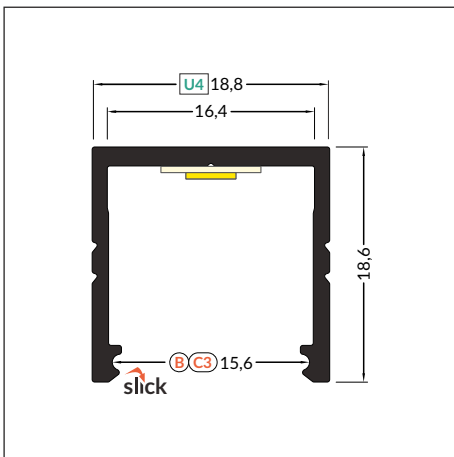
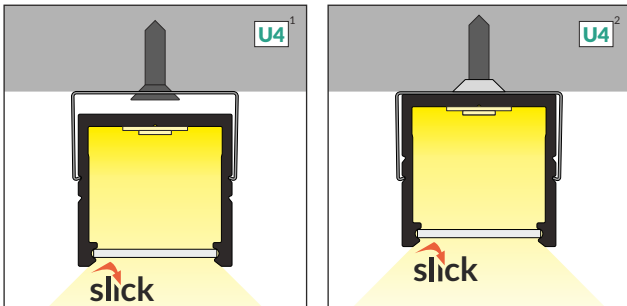
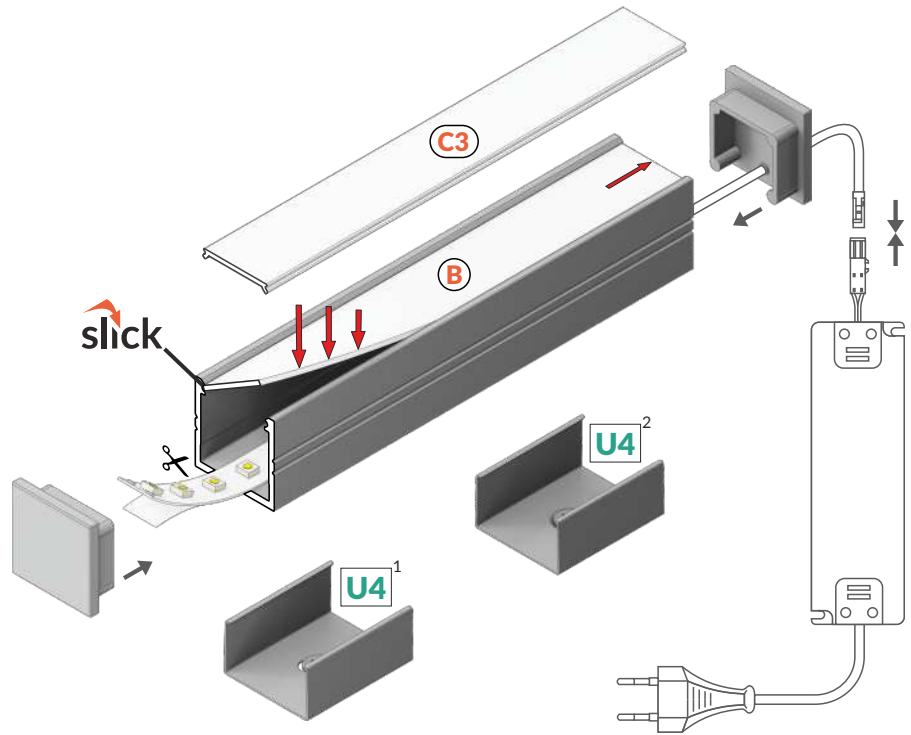

 max 16 mm

 surface
nawierzchniowy



INDEX = 1 pc, length 2000 mm
package > check the pricelist
INDEKS = 1 szt., długość 2000 mm
opakowanie > patrz cennik

white painted
biały malowany
F1020001

anodized
anodowany
F1020020

black anodized
czarny anodowany
F1020021

raw aluminium
surowe aluminium
F1020000

Available lengths: 1000 mm, 2000 mm, 3000 mm, 4000 mm.
The standard profile length tolerance is +20 mm.
More details >> 1.08.

Dostępne długości: 1000 mm, 2000 mm, 3000 mm, 4000 mm.
Standardowa tolerancja długości profili wynosi: +20 mm.
Więcej informacji >> 1.08.



COVERS / KLOSZE

B slide cover

colours: transparent, frosted, opal
material: PC, PP, PP

klosz B wsuwany
kolory: transparentny, szron, mleczny
materiał: PC, PP, PP



Note! Dimensions of the space to install LED source
Uwaga! Wymiary przestrzeni do zamontowania źródła LED

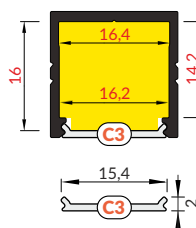
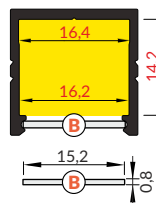

C3 click cover

colours: transparent, opal
material: PMMA



klosz C3 klik
kolory: transparentny, mleczny
materiał: PMMA



length 2000 mm
package > check the pricelist
długość 2000 mm
opakowanie > patrz cennik

B transparent / B transparentny
index = 10 pcs / indeks = 10 szt.

76250016

B frosted / B szron

index = 10 pcs / indeks = 10 szt.

76250039

B opal / B mleczny

index = 10 pcs / indeks = 10 szt.

76250038

C3 transparent

C3 transparentny

index = 1 pc / indeks = 1 szt.

F1000216

C3 opal / C3 mleczny

index = 1 pc / indeks = 1 szt.

F1000238

The standard cover length tolerance is +20 mm.
More details >> 1.08.

Standardowa tolerancja długości kloszy wynosi: +20 mm
Więcej informacji >> 1.08.

ENDINGS / ZAŚLEPKI

SMART16 ending

colours: white, silver, black, grey
material: ABS

zaślepka SMART16
kolory: biały, srebrny, czarny, szary
materiał: ABS

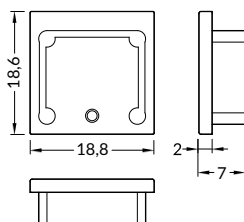

Ending with marked space to bore the holes.
Zaślepka z punktami do przewiercenia otworów.

INDEX = 10 sets = 20 pcs
package > check the pricelist
INDEKS = 10 kpl = 20 szt.
opakowanie > patrz cennik

white / biały
F1990001

silver / srebrny
F1990040

black / czarny
F1990002

grey / szary
F1990022

MOUNTINGS / MOCOWANIA

U4 mounting plate
colours: white, inox, black
material: stainless steel

uchwyt U4
kolory: biały, inox, czarny
materiał: stal nierdzewna

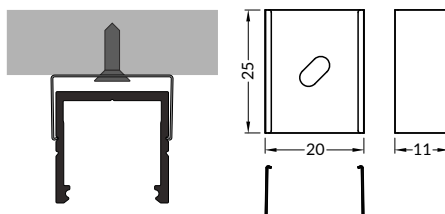

INDEX = 10 sets = 20 pcs
package > check the pricelist
INDEKS = 10 kpl = 20 szt.
opakowanie > patrz cennik

white / biały
F1970001

inox
F1970019

black / czarny
F1970002



MOUNTINGS / MOCOWANIA

cone **U4** mounting plate
colours: white, inox, black
material: stainless steel

uchwyt **U4** cone
kolory: biały, inox, czarny
materiał: stal nierdzewna

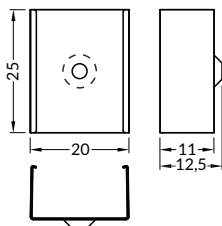
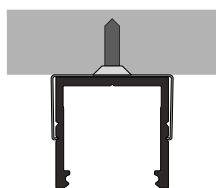

INDEX = 10 sets = 20 pcs
package > check the pricelist
INDEKS = 10 kpl = 20 szt.
opakowanie > patrz cennik

white / biały
F1980001

inox
F1980019

black / czarny
F1980002



LINEA20 EF/TY

EFFICIENT LUMINAIRE CUT TO SIZE

WYDAJNA OPRAWA Z METRA

- over 20 accessories available
- possibility of suspension along with the power supply
- LED modules are assembled with extra clamps
- angled connections illuminated
- continuous light line (with 120 P/m LED strip and opal cover applied)
- maximum LED source width: 20 mm

- ponad 20 akcesoriów
- możliwość zawieszenia na zasilaniu
- montaż modułów LED dociskiem
- świecące połączenia kątowe
- ciągła linia światła (przy użyciu taśm 120 P/m oraz klosza mlecznego)
- maksymalna szerokość źródła LED: 20 mm

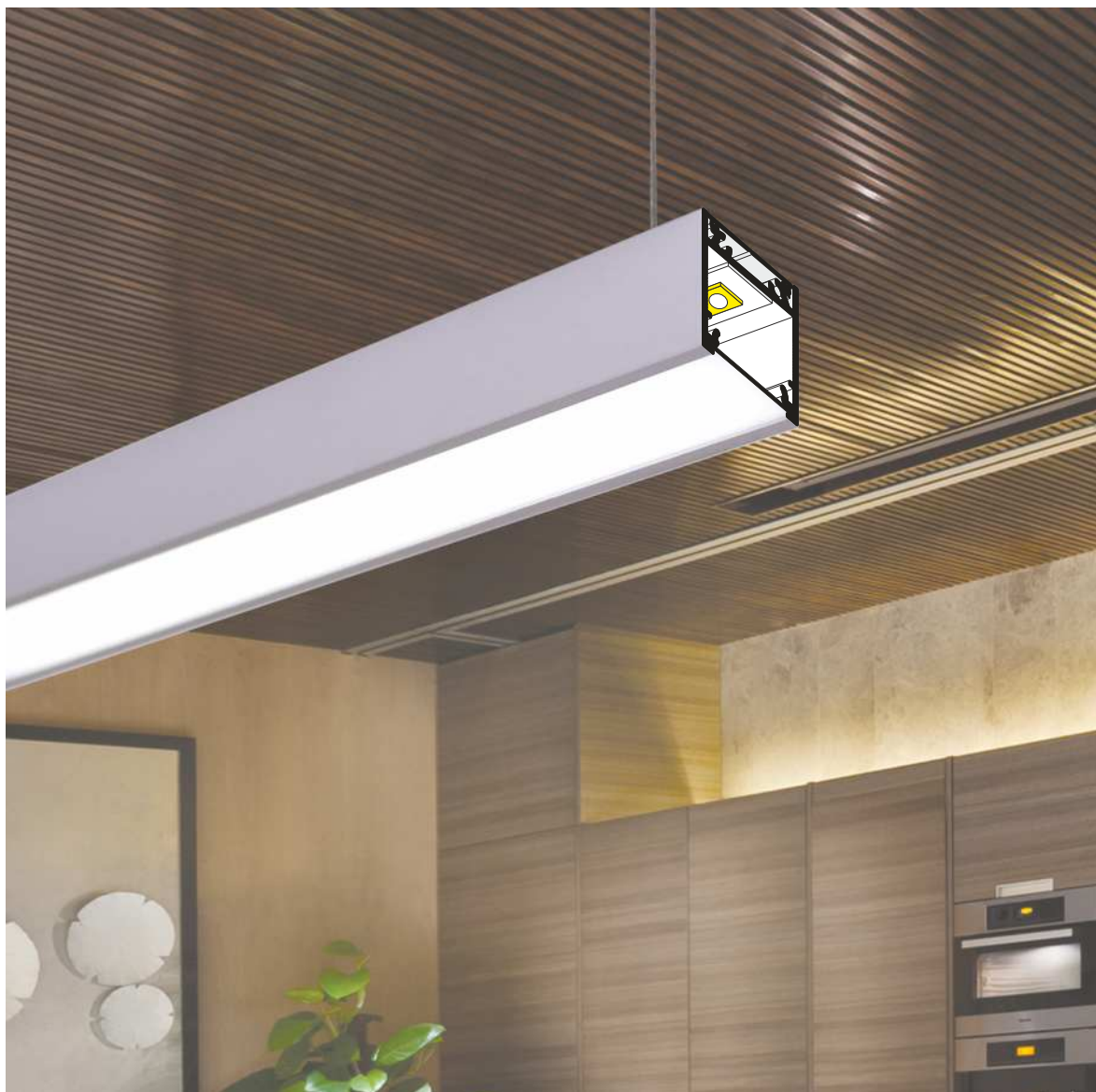

SIMILAR IN THE OFFER / PODOBNE W OFERCIE



LINEA-IN20
EF/U7



SURFACE14
EF/TY



WIDE24
G/W



VARIO30-01

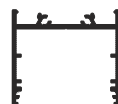

VARIO30-02



E slide cover
klosz E wsuwany

F click cover
klosz F klik

E7 click cover
klosz E7 klik

Y¹ flexible mounting plate
uchwyt Y sprężysty

Y² cone Y flexible mounting plate
uchwyt Y sprężysty cone

T mounting plate
uchwyt T

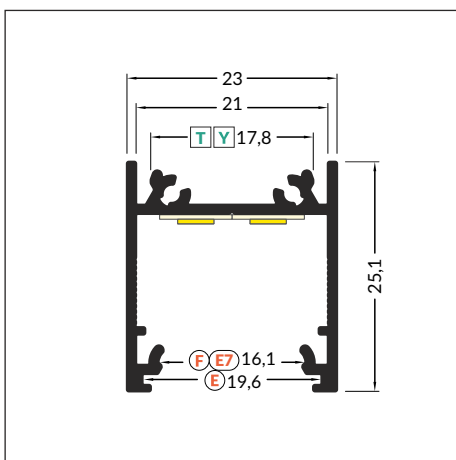
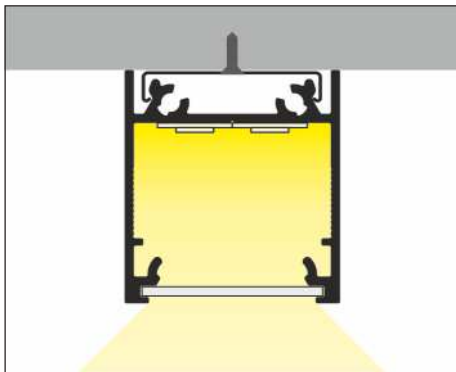
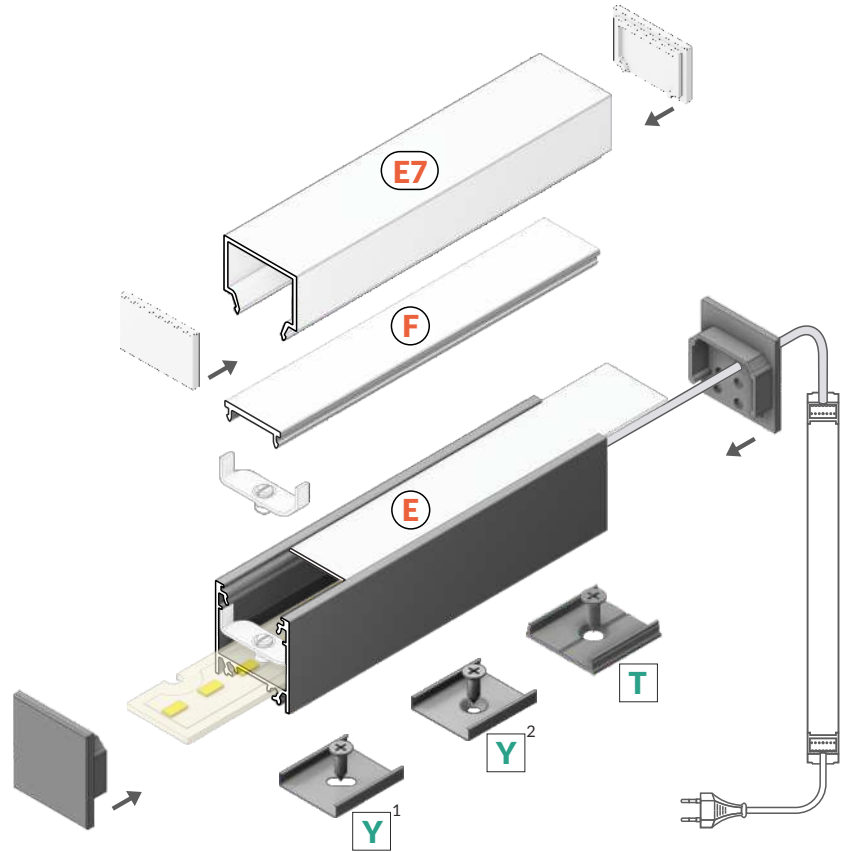

max 20 mm

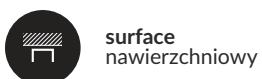

surface
nawierzchniowy



INDEX = 1 pc, length 2000 mm
package > check the pricelist
INDEKS = 1 szt., długość 2000 mm
opakowanie > patrz cennik

white painted
biały malowany
C1020001



anodized
anodowany
C1020020



black anodized
czarny anodowany
C1020021



raw aluminium
surowe aluminium
C1020000

Available lengths: 1000 mm, 2000 mm, 3000 mm, 4000 mm.
The standard profile length tolerance is +20 mm.
More details >> 1.08.

Dostępne długości: 1000 mm, 2000 mm, 3000 mm, 4000 mm.
Standardowa tolerancja długości profili wynosi: +20 mm.
Więcej informacji >> 1.08.

LINEA20 EF/TY



CONTINUOUS LIGHT LINE
The LINEA20 180° connector provides an aesthetic, continuous light line of any length.

CIĄGŁA LINIA ŚWIATŁA
Dzięki wykorzystaniu łącznika LINEA20 180° możliwe jest uzyskanie estetycznej, nieprzerwanej linii światła o dowolnej długości.



COVERS / KLOSZE

E slide cover

colours: transparent, frosted, opal
material: PC, PP, PP

klosz E wsuwany
kolory: transparentny, szron, mleczny
materiał: PC, PP, PP



Note! Dimensions of the space to install LED source
Uwaga! Wymiary przestrzeni do zamontowania źródła LED

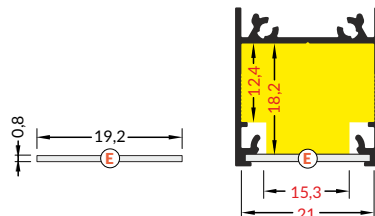

F click cover

colours: transparent, opal
material: PMMA

klosz F klik
kolory: transparentny, mleczny
materiał: PMMA

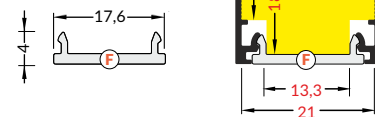

E7 click cover

colour: opal
material: PMMA

klosz E7 klik
kolor: mleczny
materiał: PMMA

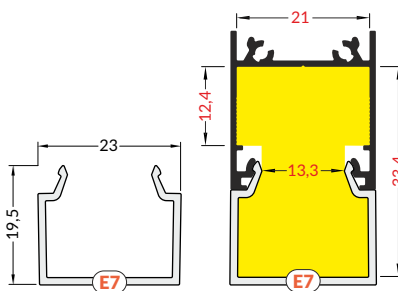

NEW

length 2000 mm
package > check the pricelist
długość 2000 mm
opakowanie > patrz cennik

E transparent / E transparentny
index = 10 pcs / indeks = 10 szt.

A2040016

E frosted / E szron
index = 10 pcs / indeks = 10 szt.

A2040039

E opal / E mleczny
index = 10 pcs / indeks = 10 szt.

A2040038

F transparent / F transparentny
index = 1 pc / indeks = 1 szt.

A2060016

F opal / F mleczny
index = 1 pc / indeks = 1 szt.

A2060038

reel, length 20 m
package > check the pricelist
rolka, długość 20 m
opakowanie > patrz cennik

F opal / F mleczny
index = 1 pc / indeks = 1 szt.

A2210038S

length 2000 mm
package > check the pricelist
długość 2000 mm
opakowanie > patrz cennik

E7 opal / E7 mleczny
index = 1 pc / indeks = 1 szt.

C1080038

The standard cover length tolerance is +20 mm.
More details >> 1.08.

Standardowa tolerancja długości kloszy wynosi: +20 mm
Więcej informacji >> 1.08.

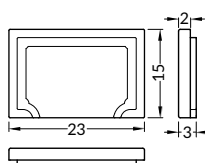

INDEX = 1 set = 2 pcs
package > check the pricelist
INDEKS = 1 kpl = 2 szt.
opakowanie > patrz cennik

E7 opal ending
zaślepka E7 mleczny

C1840038



LED MOUNTING / MOCOWANIE LED

LINEA20 LED mounting
material: aluminium

mocowanie LED LINEA20
materiał: aluminium

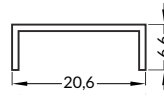

INDEX = 1 pc, length 2000 mm
package > check the pricelist
INDEKS = 1 szt., długość 2000 mm
opakowanie > patrz cennik

raw aluminium
surowe aluminium
C6060000

Available lengths: 1000 mm,
2000 mm, 3000 mm, 4000 mm.
The standard profile length
tolerance is +20 mm.
More details >> 1.08.

Dostępne długości: 1000 mm,
2000 mm, 3000 mm, 4000 mm.
Standardowa tolerancja
długości profili wynosi: +20 mm.
Więcej informacji >> 1.08.

LIGHTING EFFECT / EFEKT ŚWIECENIA

LINEA20 LED mounting + LINEA20-1 LED clamp / Mocowanie LED LINEA20 + docisk LED LINEA20-1

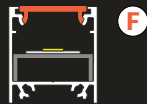
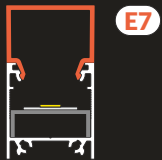

Lighting effect without LINEA20 LED mounting / Efekt świecenia bez użycia mocowania LED LINEA20

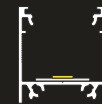



CLAMP / DOCISK

LINEA20 LED clamp
colour: white
material: painted steel, plastic

docisk LED LINEA20
kolor: biały
materiał: stal malowana,
tworzywo

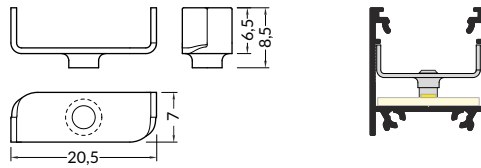

INDEX = 10 sets = 20 pcs
INDEKS = 10 kpl = 20 szt.

white
biały
C6940001

LINEA20-1 LED clamp
colour: white
material: painted steel, plastic

docisk LED LINEA20-1
kolor: biały
materiał: stal malowana,
tworzywo

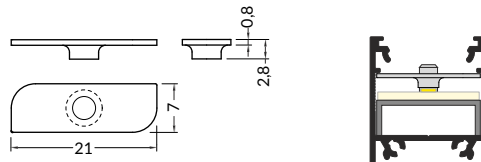

white
biały
C6930001

ENDINGS / ZAŚLEPKI

LINEA20 ending
colours: white, silver, black, grey
material: ABS

zaślepka LINEA20
kolory: biały, srebrny, czarny, szary
materiał: ABS

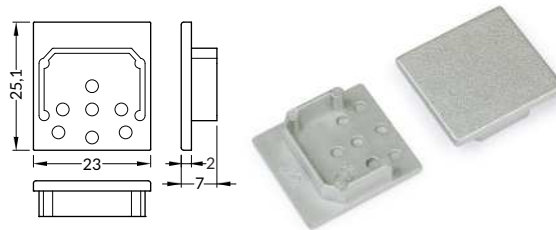

INDEX = 10 sets = 20 pcs
package > check the pricelist
INDEKS = 10 kpl = 20 szt.
opakowanie > patrz cennik

white / biały
C1940001

silver / srebrny
C1940040

black / czarny
C1940002

grey / szary
C1940022



Ending with marked space to bore the holes.
Possibility of buying dedicated screws.
Zaślepka z punktami do przewiercenia otworów.
Istnieje możliwość zakupu dedykowanych wkrętów.

LINEA20-E7 ending
colours: white, silver, black, grey

zaślepka LINEA20-E7
kolory: biały, srebrny, czarny, szary
materiał: ABS

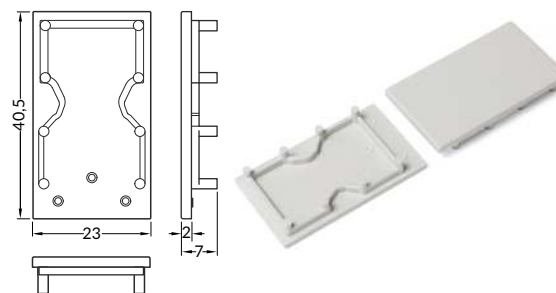

INDEX = 10 sets = 20 pcs
package > check the pricelist
INDEKS = 10 kpl = 20 szt.
opakowanie > patrz cennik

white / biały
C1999901

silver / srebrny
C1999940

black / czarny
C1999902

grey / szary
C1999922



Ending with marked space to bore the holes.
Possibility of buying dedicated screws.
Zaślepka z punktami do przewiercenia otworów.
Istnieje możliwość zakupu dedykowanych wkrętów.

screws for LED endings
colours: white, silver, black, inox

wkręty do zaślepek LED
kolory: biały, srebrny, czarny, inox

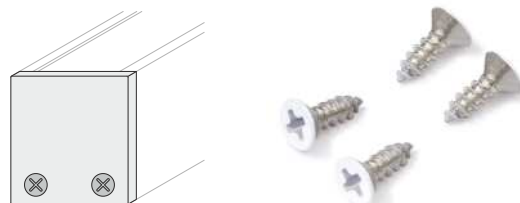

INDEX = 10 sets = 40 pcs
package > check the pricelist
INDEKS = 10 kpl = 40 szt.
opakowanie > patrz cennik

white / biały
B1900001

silver / srebrny
B1900040

black / czarny
B1900002

inox
B1900019

LINEA20 EF/TY

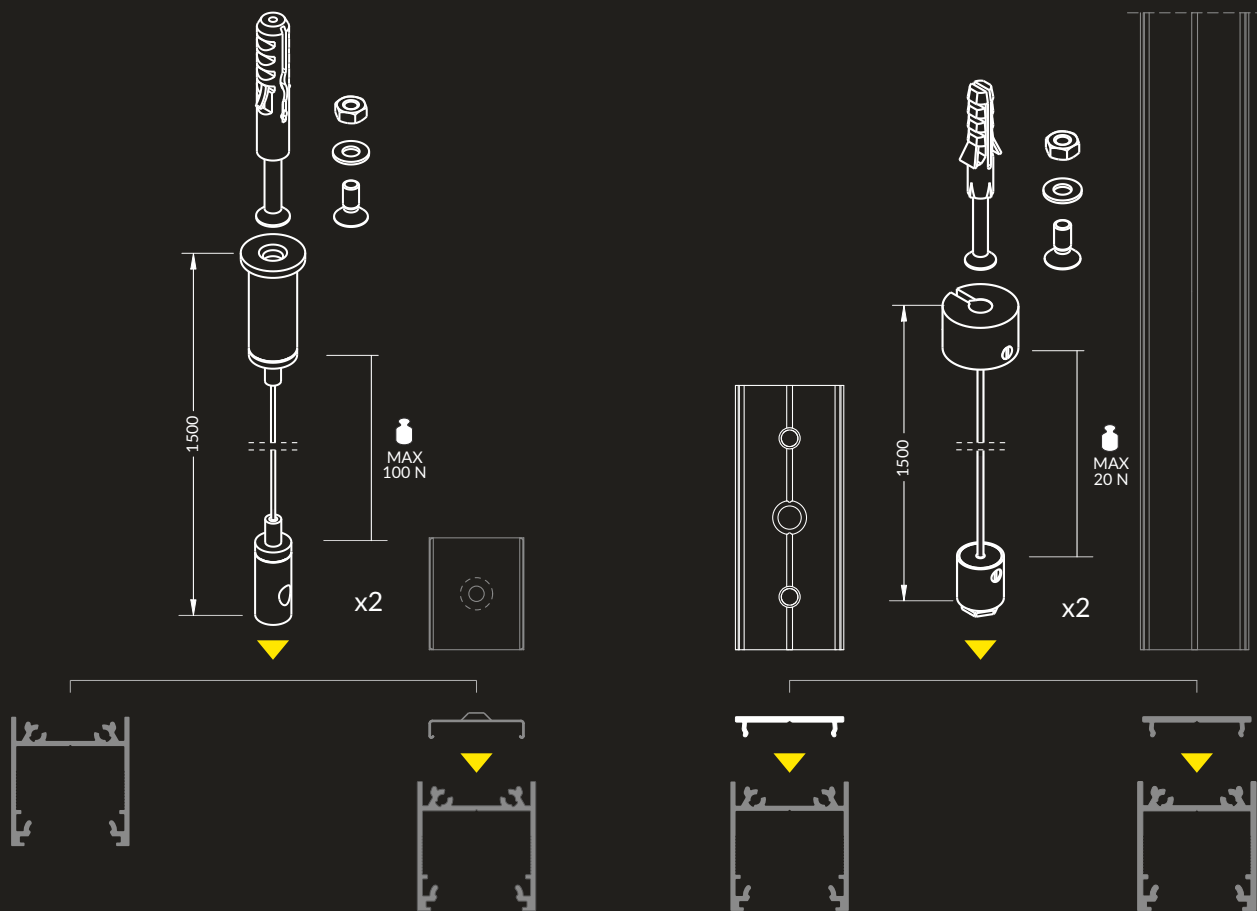

SLING FOR LED MOUNTING 1500

Compatible with flexible mounting plates, allows fast and easy assembly of the luminaire. Possibility of direct mounting to the profile.

ZAWIESIE DO UCHWYTU LED 1500

Kompatybilność z uchwytami sprężystymi, pozwala na szybki i łatwy montaż oprawy. Możliwy jest również montaż bezpośrednio do profilu.



SELV SLING 50 V 1500

It provides a minimalistic look – no additional wires required.

ZAWIESIE ZASILAJĄCE SELV 50 V 1500

Zapewnia minimalistyczny wygląd - bez konieczności doprowadzania dodatkowych przewodów.



Using FIX16 profile creates an aesthetic, closed from the top, luminaire.

Przy zastosowaniu profilu FIX16 tworzymy estetyczną, domkniętą od góry oprawę.

Drill Ø 5 mm mounting holes in FIX16

W profilu FIX16 należy wykonać otwory montażowe Ø 5 mm



MOUNTINGS / MOCOWANIA

Y flexible mounting plate

colour: inox
material: stainless steel

uchwyt Y sprężysty
kolor: inox
materiał: stal nierdzewna

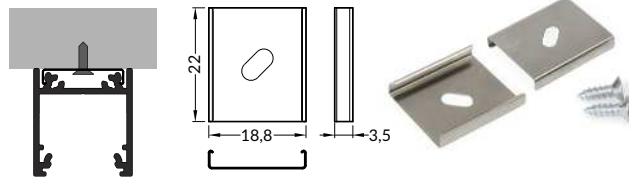

INDEX = 10 sets = 20 pcs
package > check the pricelist
INDEKS = 10 kpl = 20 szt.
opakowanie > patrz cennik

inox
A2090019

cone Y flexible mounting plate

colour: inox
material: stainless steel

uchwyt Y sprężysty cone
kolor: inox
materiał: stal nierdzewna

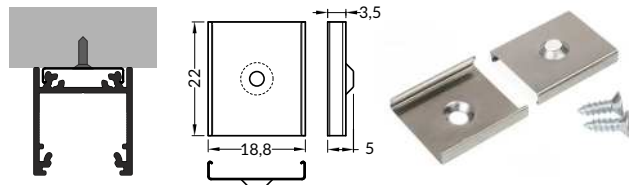

inox
A2130019

T mounting plate

colour: raw aluminium
material: aluminium

uchwyt T
kolor: surowe aluminium
materiał: aluminium

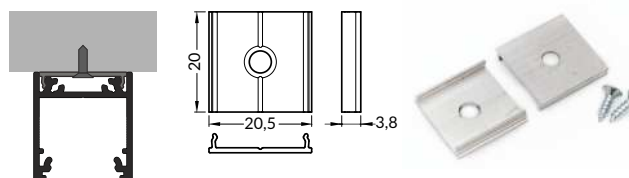

raw aluminium
surowe aluminium
C6960000

ALUMINIUM COVER / OSŁONA ALUMINIOWA

LED profile FIX16

colours: white, anodized, black, raw aluminium
material: aluminium

profil LED FIX16

kolory: biały, anodowany, czarny, surowe aluminium
materiał: aluminium

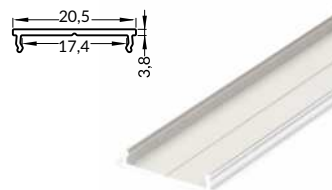

Available lengths: 1000 mm, 2000 mm, 3000 mm, 4000 mm.
The standard profile length tolerance is +20 mm. More details >> 1.08.
Dostępne długości: 1000 mm, 2000 mm, 3000 mm, 4000 mm.
Standardowa tolerancja długości profili wynosi: +20 mm. Więcej informacji >> 1.08.

INDEX = 1 pc, length 2000 mm
package > check the pricelist
INDEKS = 1 szt., długość 2000 mm
opakowanie > patrz cennik

white painted
biały malowany
C6020001

anodized
anodowany
C6020020

black anodized
czarny anodowany
C6020021

raw aluminium
surowe aluminium
C6020000

SLING / ZAWIESIE

SELV sling 50 V 1500

colours: white, silver, black

zawiesie SELV 50 V 1500
kolory: biały, srebrny, czarny



INDEX = 1 set = 2 pcs
package > check the pricelist
INDEKS = 1 kpl = 2 szt.
opakowanie > patrz cennik

white
biały
67120001

silver
srebrny
67120022

black
czarny
67120002

sling for LED mounting 1500

colour: chrome

zawiesie do uchwyty LED 1500
kolor: chrom



chrome
chrom
67140003

LINEA20 EF/TY

CONNECTION POSSIBILITY MOŻLIWOŚCI ŁĄCZENIA



60°



90°



120°



135°



180°

ANGULAR CONNECTORS

Thanks to five different angle connectors (60° / 90° / 120° / 135° / 180°) it is possible to create many various lighting systems - with no need to cut the profile at an angle.

Bent connectors allows to connect profiles in two planes, at two angles: 90° on the inside and 270° on the outside.

ŁĄCZNIKI KĄTOWE

Dzięki łącznikom o pięciu różnych kątach (60° / 90° / 120° / 135° / 180°) możliwe jest tworzenie wielu różnych układów oświetlenia bez konieczności cięcia profilu pod skosem.

Łączniki gięte umożliwiają łączenie profili w dwóch płaszczyznach, pod dwoma kątami: wewnętrznym 90° i zewnętrznym 270°.



The component made of clear fabric provides secure connection, letting light through at the same time. Thanks to that, the luminaire can illuminate on the entire surface of the cover - even in the corners.

Element z przejrzystego tworzywa zapewnia stabilizację łączenia, jednocześnie przepuszczając światło. Dzięki temu oprawa może świecić na całej powierzchni klosza - również w rogach.



CONNECTORS / ŁĄCZNIKI

LINEA20 connector 60 deg
colours: white, anodized, black
material: aluminium, polycarbonate

łącznik LINEA20 60 st
kolory: biały, anodowany, czarny
materiał: aluminium, poliwęglan

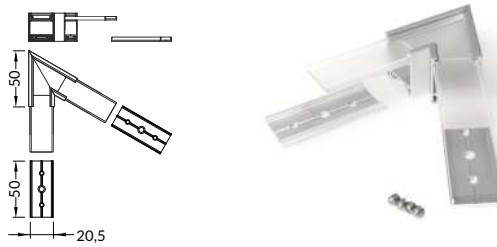

white painted / biały malowany
C1850001

anodized / anodowany
C1850020

black anodized / czarny anodowany
C1850002

LINEA20 connector 90 deg
colours: white, anodized, black
material: aluminium, polycarbonate

łącznik LINEA20 90 st
kolory: biały, anodowany, czarny
materiał: aluminium, poliwęglan



white painted / biały malowany
C1860001

anodized / anodowany
C1860020

black anodized / czarny anodowany
C1860002

LINEA20 connector 90 deg bent
colours: white, anodized, black
material: aluminium, polycarbonate

łącznik LINEA20 90 st gięty
kolory: biały, anodowany, czarny
materiał: aluminium, poliwęglan

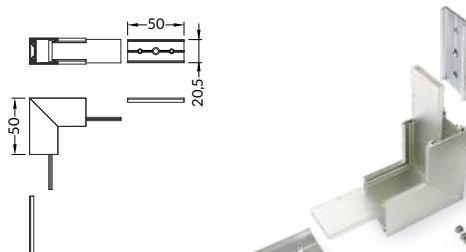

white painted / biały malowany
C1870001

anodized / anodowany
C1870020

black anodized / czarny anodowany
C1870002

LINEA20 connector 120 deg
colours: white, anodized, black
material: aluminium, polycarbonate

łącznik LINEA20 120 st
kolory: biały, anodowany, czarny
materiał: aluminium, poliwęglan

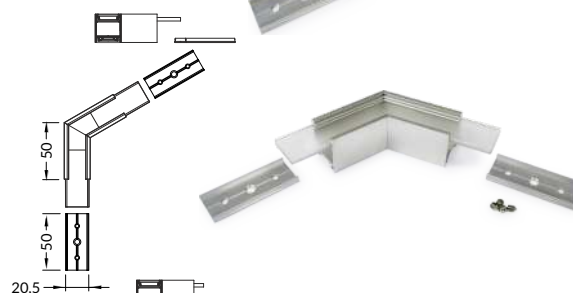

white painted / biały malowany
C1880001

anodized / anodowany
C1880020

black anodized / czarny anodowany
C1880002

LINEA20 connector 135 deg
colours: white, anodized, black
material: aluminium, polycarbonate

łącznik LINEA20 135 st
kolory: biały, anodowany, czarny
materiał: aluminium, poliwęglan

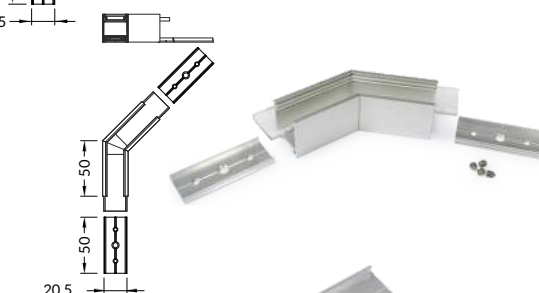

white painted / biały malowany
C1890001

anodized / anodowany
C1890020

black anodized / czarny anodowany
C1890002

LINEA20 connector 180 deg
material: aluminium, polycarbonate

łącznik LINEA20 180 st
materiał: aluminium, poliwęglan



C1900000

LINEA20 connector 270 deg bent
colours: white, anodized, black
material: aluminium, polycarbonate

łącznik LINEA20 270 st gięty
kolory: biały, anodowany, czarny
materiał: aluminium, poliwęglan

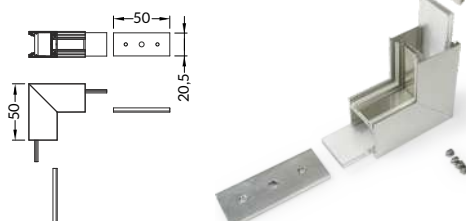

white painted / biały malowany
C1910001

anodized / anodowany
C1910020

black anodized / czarny anodowany
C1910002

LINEA20 EF/TY





PENDANT LUMINAIRE

Thanks to wide range of profile accessories it could be applied in many arrangements. SELV sling 50 V 1500 and FIX16 closing profile allows to create pendant luminaire with a small intersection, but strong light.

OPRAWA WISZĄCA

Dzięki licznym akcesoriom profil można zastosować w wielu aranżacjach. Zawiesie SELV 50 V 1500 oraz domykający profil FIX16 pozwalają stworzyć wiszącą oprawę o niewielkim przekroju, ale dającą silne światło.

WIDE, ALUMINIUM, SURFACE PROFILE

SZEROKI, ALUMINIOWY PROFIL NAWIERZCHNIOWY

- possibility of installing 3 8 mm LED strips
- Slick socket
- maximum LED strip width: 24 mm
- możliwość zastosowania równoległe 3 taśm 8 mm
- gniazdo z funkcją Slick
- maksymalna szerokość taśmy LED: 24 mm



SIMILAR IN THE OFFER / PODOBNE W OFERCIE





G slide cover
klosz G wsuwany

W cone W flexible mounting plate
uchwyt W sprężysty cone

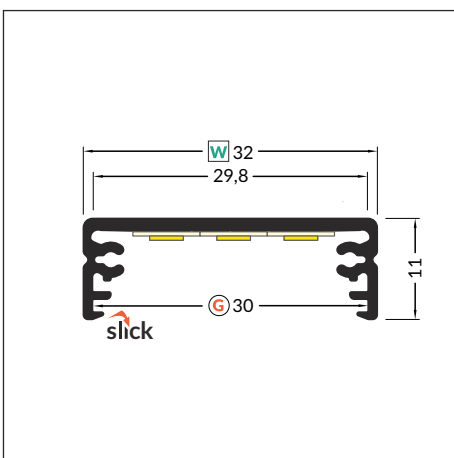
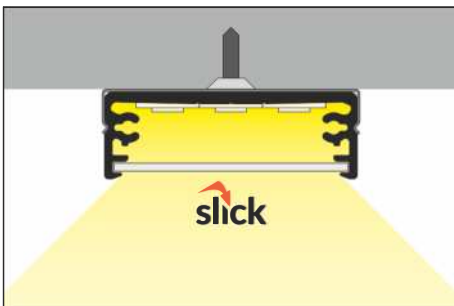
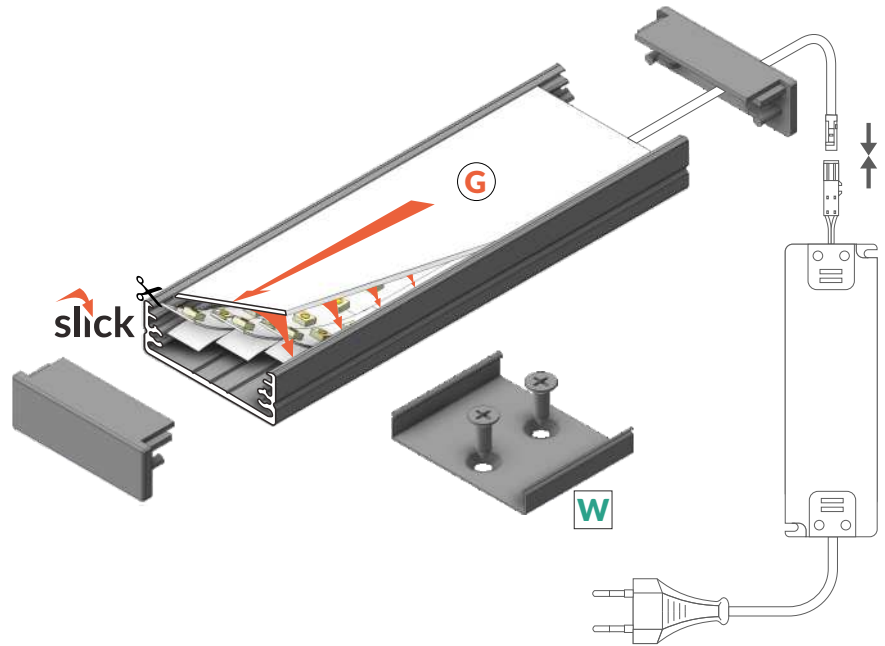

 max 24 mm

 surface
nawierzchniowy



INDEX = 1 pc, length 2000 mm
package > check the pricelist
INDEKS = 1 szt., długość 2000 mm
opakowanie > patrz cennik

white painted
biały malowany
84030001



anodized
anodowany
84030020



black anodized
czarny anodowany
84030021



raw aluminium
surowe aluminium
84030000

Available lengths: 1000 mm, 2000 mm, 3000 mm, 4000 mm.
The standard profile length tolerance is +20 mm.
More details >> 1.08.

Dostępne długości: 1000 mm, 2000 mm, 3000 mm, 4000 mm.
Standardowa tolerancja długości profili wynosi: +20 mm.
Więcej informacji >> 1.08.



COVERS / KLOSZE

G slide cover
colours: transparent, frosted, opal
material: PC, PP, PP

klosz **G** wsuwany
kolory: transparentny, szron, mleczny
materiał: PC, PP, PP



Note! Dimensions of the space to install LED source
Uwaga! Wymiary przestrzeni do zamontowania źródła LED

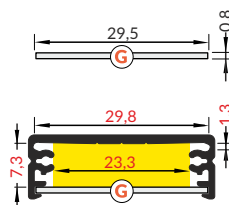

length 2000 mm
package > check the pricelist
długość 2000 mm
opakowanie > patrz cennik

G transparent / G transparentny
index = 10 pcs / indeks = 10 szt.
84070016

G frosted / G szron
index = 10 pcs / indeks = 10 szt.
84070039

G opal / G mleczny
index = 10 pcs / indeks = 10 szt.
84070038

The standard cover length tolerance is +20 mm.
More details >> 1.08.

Standardowa tolerancja długości kloszy wynosi: +20 mm
Więcej informacji >> 1.08.

ENDINGS / ZAŚLEPKI

WIDE24 ending
colours: white, silver, black, grey
material: ABS
zaślepka WIDE24
kolory: biały, srebrny, czarny, szary
materiał: ABS

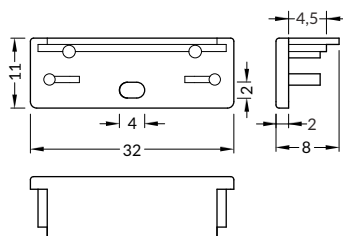

INDEX = 10 sets = 20 pcs
package > check the pricelist
INDEKS = 10 kpl = 20 szt.
opakowanie > patrz cennik

white / biały
84040001

silver / srebrny
84040040

black / czarny
84040002

grey / szary
84040022

WIDE24 ending with hole
colours: white, silver, black, grey
material: ABS
zaślepka WIDE24 z otworem
kolory: biały, srebrny, czarny, szary
materiał: ABS



white / biały
84300001

silver / srebrny
84300040

black / czarny
84300002

grey / szary
84300022

MOUNTINGS / MOCOWANIA

cone W flexible mounting plate
colour: white, inox, black
material: stainless steel

uchwyt **W** sprężysty cone
kolor: biały, inox, czarny
materiał: stal nierdzewna

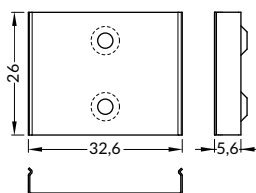
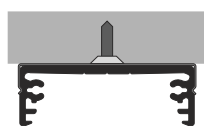

INDEX = 10 sets = 20 pcs
package > check the pricelist
INDEKS = 10 kpl = 20 szt.
opakowanie > patrz cennik

white / biały
84510001

inox
84510019

black / czarny
84510002

WIDE24 simple holder
material: zinc coated steel

uchwyt WIDE24 prosty
materiał: stal ocynkowana

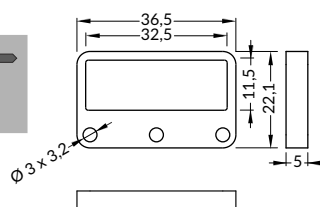
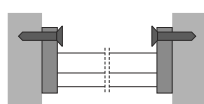

INDEX = 1 set = 2 pcs
package > check the pricelist
INDEKS = 1 kpl = 2 szt.
opakowanie > patrz cennik

zinc coated
stal ocynkowana
84220030



SLING / ZAWIESIE

SELV sling 50 V 1500
colours: white, silver, black

zawiesie SELV 50 V 1500
kolory: biały, srebrny, czarny

sling for LED mounting 1500
colour: chrome

zawiesie do uchwytu LED 1500
kolor: chrom



INDEX = 1 set = 2 pcs
package > check the pricelist
INDEKS = 1 kpl = 2 szt.
opakowanie > patrz cennik

white
biały
67120001

silver
srebrny
67120022

black
czarny
67120002

chrome
chrom
67140003





2020 LED PROFILES

PROFILE LED

RECESSED / WPUSTOWE



FLAT8 H/UX

FLAT RECESSED PROFILE EMITTING DIFFUSED LIGHT GLOW

PŁASKI, WPUSTOWY PROFIL EMITUJĄCY ROZPROSZONĄ ŁUNĘ ŚWIATŁA

- decorative illumination
- a parabolic, reflecting element - even, smooth, diffused light
- a flat profile, designed to fit into plasterboards - installation without interference in the frame construction
- mounted to furniture, walls, pedestals with holders (click-in) or directly (with screws, adhesive tape or glue)
- maximum LED strip width: 8 mm

- oświetlenie dekoracyjne
- paraboliczny odbłyśnik - równomierne, gładkie, rozproszone światło
- płaski profil mieszczący się w grubości płyty karton-gips, montaż bez ingerencji w stelaż zabudowy
- montaż do mebli, ścian, cokołów za pomocą uchwyty (wklikując) lub bezpośrednio (przykręcając lub wklejając)
- maksymalna szerokość taśmy LED: 8 mm



SIMILAR IN THE OFFER / PODOBNE W OFERCIE



DEEP10
BC/UX



BACK10
A/UX



WALLE12
CD

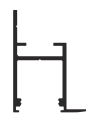

FRAME14
BC/Q



H slide cover
klosz H wsuwany

U¹ U flexible mounting plate
uchwyt U sprężysty

U² cone U flexible mounting plate
uchwyt U sprężysty cone

X¹ X mounting plate
uchwyt X

X² spring X mounting plate
uchwyt X sprężyna

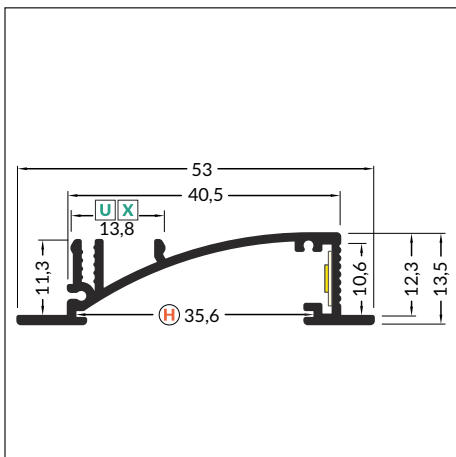
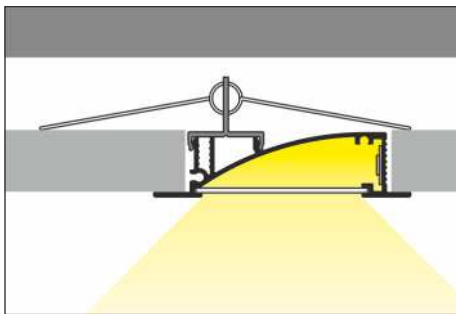
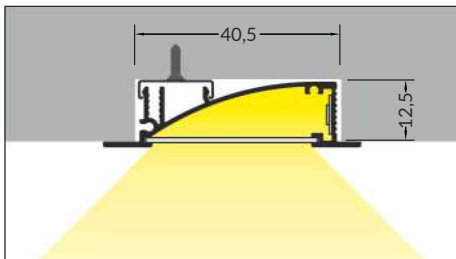
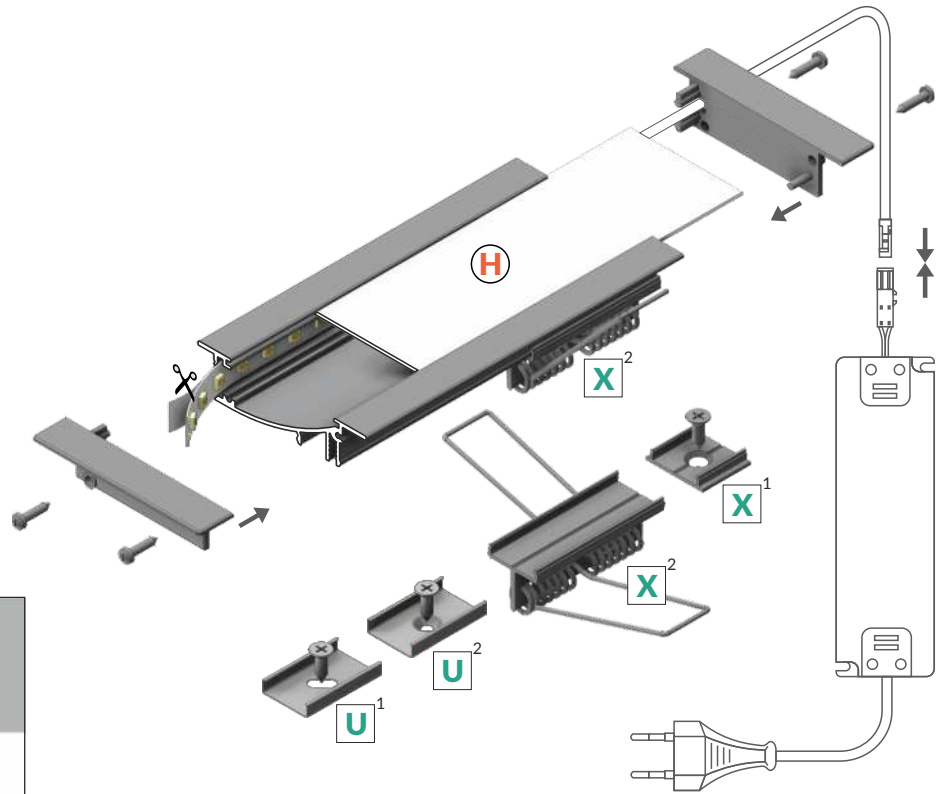

max 8 mm

recessed
wpustowy



INDEX = 1 pc, length 2000 mm
package > check the pricelist
INDEKS = 1 szt., długość 2000 mm
opakowanie > patrz cennik

white painted
biały malowany
23050001



anodized
anodowany
23050020



black anodized
czarny anodowany
23050021



raw aluminium
surowe aluminium
23050000

Available lengths: 1000 mm, 2000 mm, 3000 mm, 4000 mm.
The standard profile length tolerance is +20 mm.
More details >> 1.08.

Dostępne długości: 1000 mm, 2000 mm, 3000 mm, 4000 mm.
Standardowa tolerancja długości profili wynosi: +20 mm.
Więcej informacji >> 1.08.



COVERS / KLOSZE

H slide cover

colours: transparent, frosted, opal
material: PC, PP, PP

klosz H wsuwany
kolory: transparentny, szron, mleczny
materiał: PC, PP, PP



Note! Dimensions of the space to install LED source
Uwaga! Wymiary przestrzeni do zamontowania źródła LED

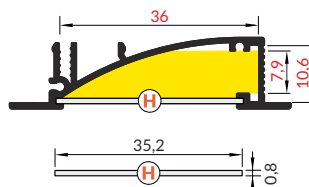

length 2000 mm
package > check the pricelist
długość 2000 mm
opakowanie > patrz cennik

H transparent / H transparentny
index = 10 pcs / indeks = 10 szt.
23080016

H frosted / H szron
index = 10 pcs / indeks = 10 szt.
23080039

H opal / H mleczny
index = 10 pcs / indeks = 10 szt.
23080038

The standard cover length tolerance is +20 mm.
More details >> 1.08.

Standardowa tolerancja długości kloszy wynosi: +20 mm
Więcej informacji >> 1.08.

ENDINGS / ZAŚLEPKI

FLAT8 ending with hole

colours: white, silver, black, grey
material: ABS

zaślepka FLAT8 z otworem
kolory: biały, srebrny, czarny, szary
materiał: ABS

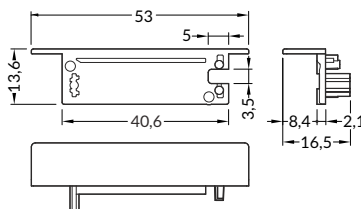

INDEX = 10 sets = 20 pcs
package > check the pricelist
INDEKS = 10 kpl = 20 szt.
opakowanie > patrz cennik

white / biały
23110001

silver / srebrny
23110040

black / czarny
23110002

grey / szary
23110022

MOUNTINGS / MOCOWANIA

U flexible mounting plate

colour: inox
material: stainless steel

uchwyt U sprężysty
kolor: inox
materiał: stal nierdzewna

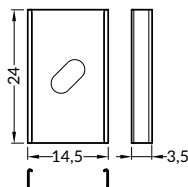
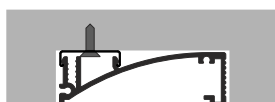

INDEX = 10 sets = 20 pcs
package > check the pricelist
INDEKS = 10 kpl = 20 szt.
opakowanie > patrz cennik

inox
76380000

cone U flexible mounting plate

colour: inox
material: stainless steel

uchwyt U sprężysty cone
kolor: inox
materiał: stal nierdzewna

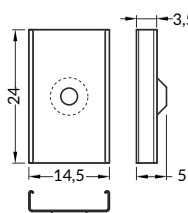

inox
76620000

X mounting plate

colour: raw aluminium
material: aluminium

uchwyt X
kolor: surowe aluminium
materiał: aluminium

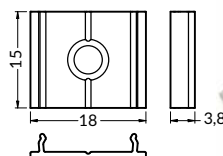
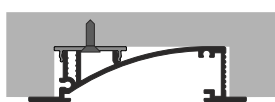

raw aluminium
surowe aluminium
76260000

spring X mounting plate

colour: raw aluminium
material: aluminium

uchwyt X sprężyna
kolor: surowe aluminium
materiał: aluminium

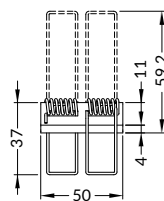
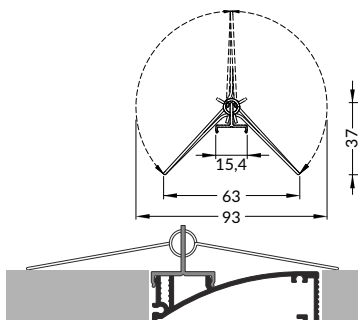

INDEX = 1 pc
package > check the pricelist
INDEKS = 1 szt.
opakowanie > patrz cennik

raw aluminium
surowe aluminium
23130000



CONNECTORS / ŁĄCZNIKI

X connector 180 deg
colour: raw aluminium
material: aluminium

łącznik X 180 st
kolor: surowe aluminium
materiał: aluminium

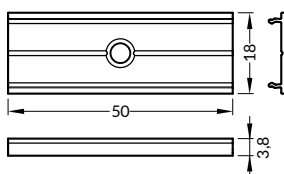

INDEX = 1 set
package > check the pricelist
INDEKS = 1 kpl
opakowanie > patrz cennik

raw aluminium
surowe aluminium

76350000

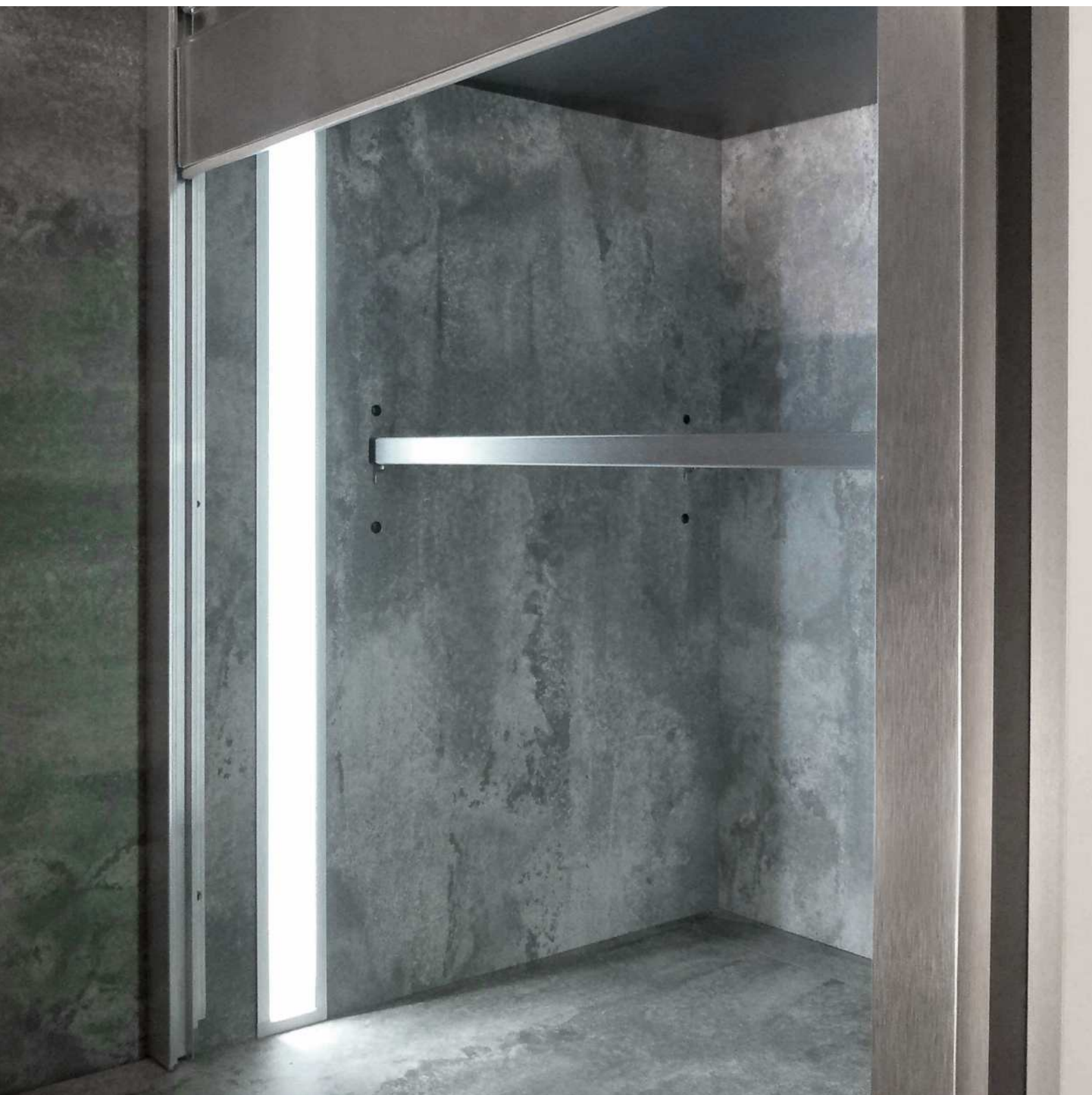

HI8 C1

THIN LINE OF LIGHT

CIENKA LINIA ŚWIATŁA

- decorative illumination
 - for counter edges, steps
 - flushes with mounting surface
 - only enlight surface of the cover is visible
 - miniature dimensions
 - maximum width of LED strip: 8 mm
-
- oświetlenie dekoracyjne
 - do montażu w krawędzi blatów, stopni
 - zlicowany z powierzchnią montażową
 - widoczna tylko świecąca powierzchnia klosza
 - miniaturowe gabaryty
 - maksymalna szerokość taśmy LED: 8 mm



SIMILAR IN THE OFFER / PODOBNE W OFERCIE

SLASH8

FLOOR12
K/U

SMART-IN10
AC2/Z



C1 C1 click cover
klosz C1 klik

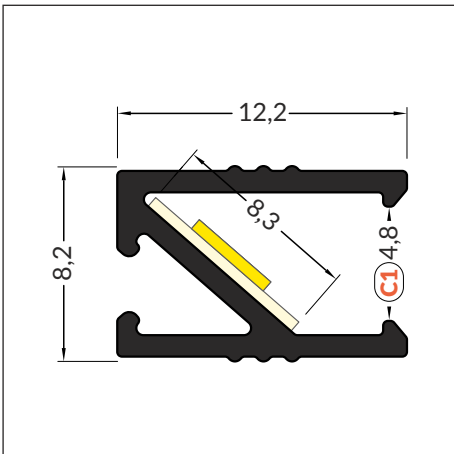
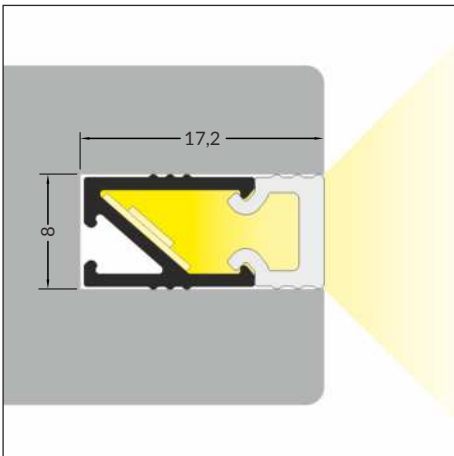
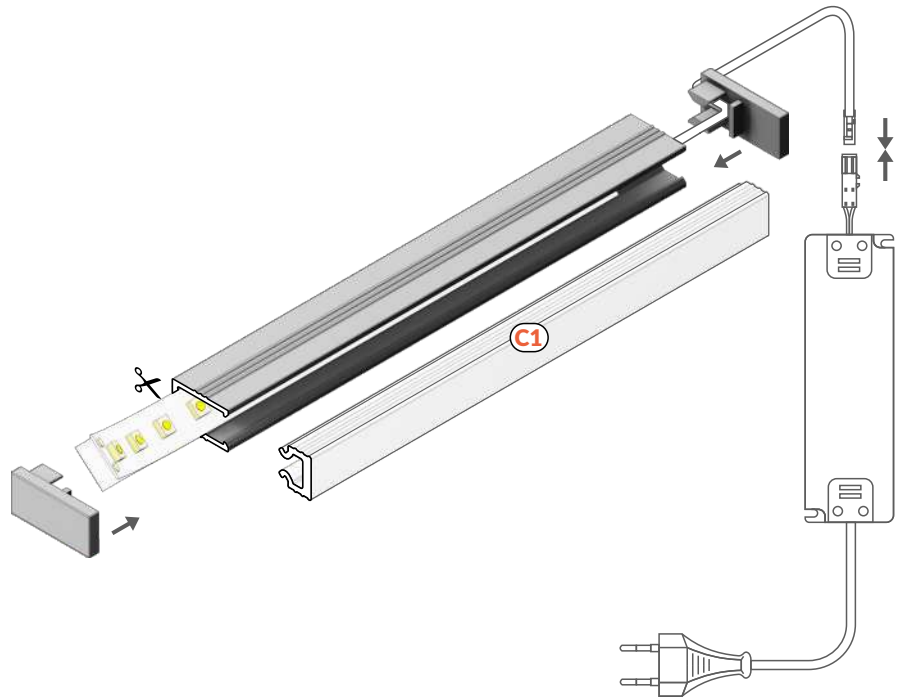

INDEX = 1 pc, length 2000 mm
package > check the pricelist
INDEKS = 1 szt., długość 2000 mm
opakowanie > patrz cennik

anodized
anodowany
H8020020

Available lengths: 1000 mm, 2000 mm, 3000 mm, 4000 mm.
The standard profile length tolerance is +20 mm.
More details >> 1.08.

Dostępne długości: 1000 mm, 2000 mm, 3000 mm, 4000 mm.
Standardowa tolerancja długości profilu wynosi: +20 mm.
Więcej informacji >> 1.08.



max 8 mm



recessed
wpustowy

COVERS / KLOSZE

C1 click cover
colour: opal
material: PMMA

klosz **C1** klik
kolor: mleczny
materiał: PMMA



Note! Dimensions of the space to install LED source
Uwaga! Wymiary przestrzeni do zamontowania źródła LED

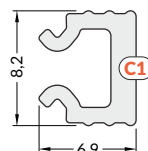
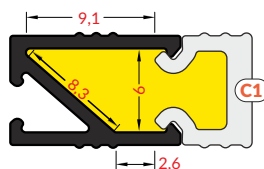

length 2000 mm
package > check the pricelist
długość 2000 mm
opakowanie > patrz cennik

C1 opal / C1 mleczny
index = 1 pc / indeks = 1 szt.

H8060038

The standard cover length tolerance is +20 mm.
More details >> 1.08.

Standardowa tolerancja długości kloszy wynosi: +20 mm
Więcej informacji >> 1.08.

ENDINGS / ZAŚLEPKI

H18 ending
colours: silver, grey, opal
material: ABS, ABS, PMMA

zaślepka H18
kolory: srebrny, szary, mleczny
materiał: ABS, ABS, PMMA

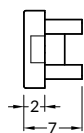
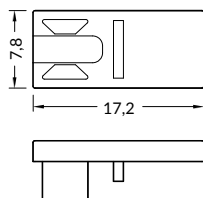

INDEX = 10 sets = 20 pcs
package > check the pricelist
INDEKS = 10 kpl = 20 szt.
opakowanie > patrz cennik

silver / srebrny
H8990040

grey / szary
H8990022

opal / mleczny
H8990038



SLASH8

NEW

STRING OF LIGHT

STRUNA ŚWIATŁA

- easy installation of the LED strip
- installation in a small gap 5x14 mm
- possibility of installation in an arc (minimum bending radius 25 cm)
- continuous line of light when using 120 P/m LED strip
- width of LED strip: 8 mm

- łatwy montaż taśmy LED
- montaż w niewielkiej szczelinie 5x14 mm
- możliwość montażu po łuku (minimalny promień gięcia 25 cm)
- ciągła linia światła przy użyciu taśmy LED 120 P/m
- szerokość taśmy LED: 8 mm



SIMILAR IN THE OFFER / PODOBNE W OFERCIE

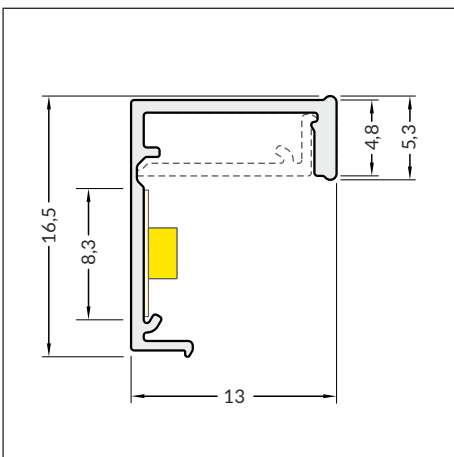
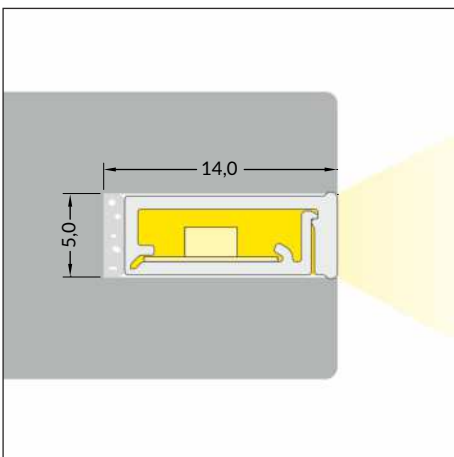
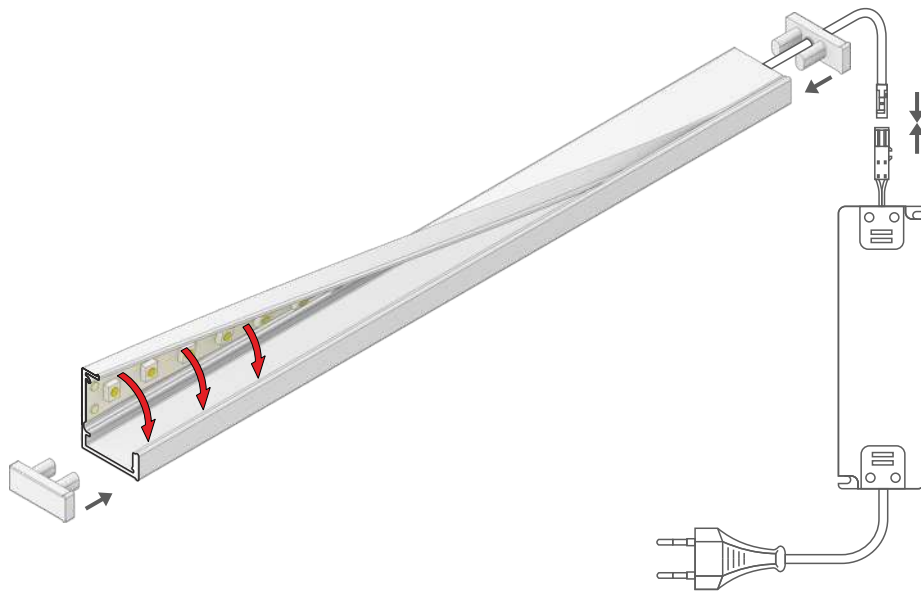

INDEX = 1 pc, length 2000 mm
package > check the pricelist
INDEKS = 1 szt., długość 2000 mm
opakowanie > patrz cennik

opal
material: PC
mleczny
material: PC
G5000220



Available lengths: 1000 mm, 2000 mm, 3000 mm, 4000 mm.
The standard profile length tolerance is +20 mm.
More details >> 1.08.

Dostępne długości: 1000 mm, 2000 mm, 3000 mm, 4000 mm.
Standardowa tolerancja długości profili wynosi: +20 mm.
Więcej informacji >> 1.08.



Note! Dimensions of the space
to install LED source
Uwaga! Wymiary przestrzeni
do zamontowania źródła LED

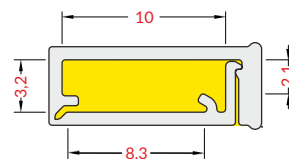

8 mm



recessed
wpustowy

ENDINGS / ZAŚLEPKI

SLASH8 ending
colour: opal
material: PMMA
zaślepka SLASH8
kolor: mleczny
materiał: PMMA

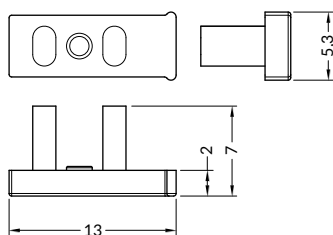

INDEX = 10 sets = 20 pcs
package > check the pricelist
INDEKS = 10 kpl = 20 szt.
opakowanie > patrz cennik

opal / mleczny
G5999922





The profile can be used to create a light drawing using straight lines or arcs.

Profil można wykorzystać do stworzenia świetlnego rysunku liniami prostymi lub po łuku.



DEEP10 BC/UX

A RECESSED PROFILE WHICH CAN GIVE A CONTINUOUS LINE EFFECT

PROFIL WPUSTOWY Z MOŻLIWOŚCIĄ UZYSKANIA CIĄGŁEJ LINII

- mainly used in furniture or plasterboard
- continuous line of light (when using LED strip 120 P/m and opal cover)
- angled profile sides are designed for better light reflection
- maximum LED strip width: 10 mm

- zastosowanie głównie meblowe lub w płycie karton-gips
- ciągła linia światła przy użyciu taśmy 120 P/m i klosza mlecznego
- ścianki profilu ustawione pod kątem działające jak odbłyśnik
- maksymalna szerokość taśmy LED: 10 mm

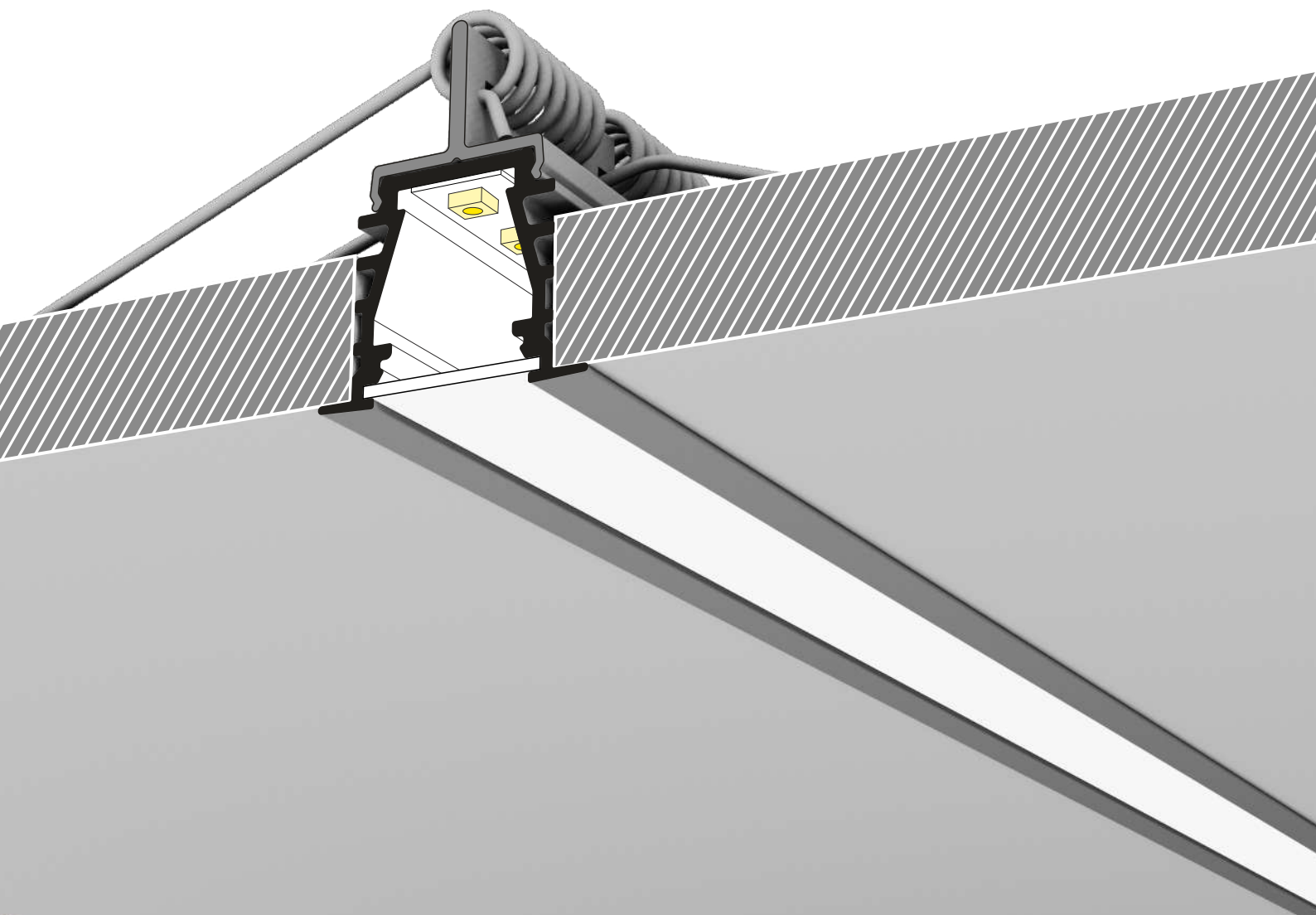

SIMILAR IN THE OFFER / PODOBNE W OFERCIE



FLAT8
H/UX



BEGTIN12
J/S



GROOVE10
BC/UX



UNI12
BCD/U



GROOVE14
EF/TY



B slide cover
klosz B wsuwany

C click cover
klosz C klik

C lens cover
klosz C soczewka

U¹ U flexible mounting plate
uchwyt U sprężysty

U² cone U flexible mounting plate
uchwyt U sprężysty cone

U³ rack U flexible mounting plate
uchwyt U sprężysty rack

X¹ X mounting plate
uchwyt X

X² spring X mounting plate
uchwyt X sprężyna

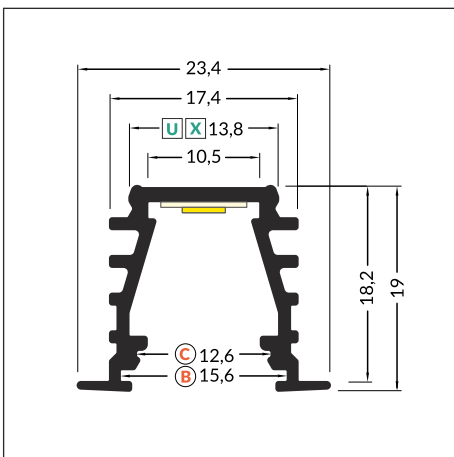
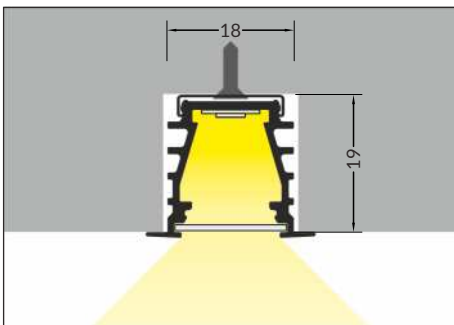
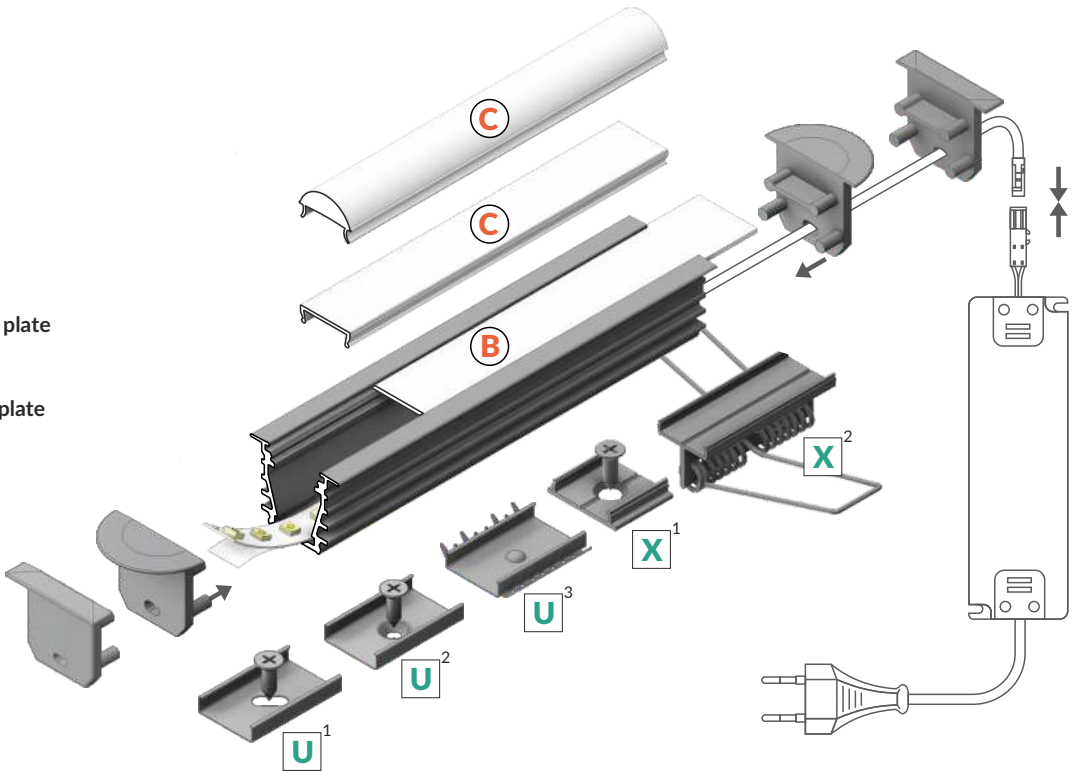

INDEX = 1 pc, length 2000 mm
package > check the pricelist
INDEKS = 1 szt., długość 2000 mm
opakowanie > patrz cennik

white painted
biały malowany

96030001



anodized
anodowany

96030020



black anodized
czarny anodowany

96030021



raw aluminium
surowe aluminium

96030000



max 10 mm



recessed
wpustowy

Available lengths: 1000 mm, 2000 mm, 3000 mm, 4000 mm.
The standard profile length tolerance is +20 mm.
More details >> 1.08.

Dostępne długości: 1000 mm, 2000 mm, 3000 mm, 4000 mm.
Standardowa tolerancja długości profili wynosi: +20 mm.
Więcej informacji >> 1.08.



COVERS / KLOSZE

B slide cover
colours: transparent, frosted, opal
material: PC, PP, PP

klosz **B** wsuwany
kolory: transparentny, szron, mleczny
materiał: PC, PP, PP



Note! Dimensions of the space
to install LED source
Uwaga! Wymiary przestrzeni
do zamontowania źródła LED

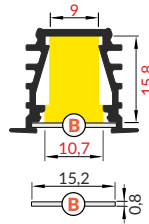

C click cover
colours: transparent, opal
material: PMMA

klosz **C** klik
kolory: transparentny, mleczny
materiał: PMMA

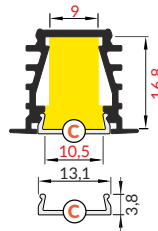

C lens click cover
colour: transparent
material: PC

klosz **C** klik soczewka
kolor: transparentny
materiał: PC

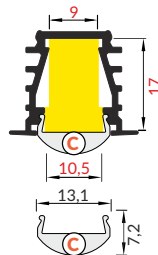

NEW

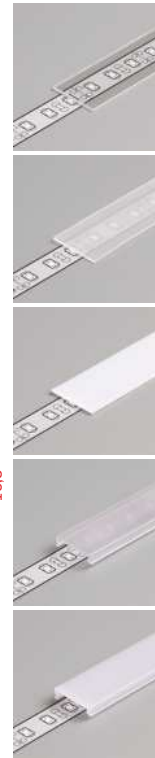

length 2000 mm
package > check the pricelist
długość 2000 mm
opakowanie > patrz cennik

B transparent / B transparentny
index = 10 pcs / indeks = 10 szt.
76250016

B frosted / B szron
index = 10 pcs / indeks = 10 szt.
76250039

B opal / B mleczny
index = 10 pcs / indeks = 10 szt.
76250038

C transparent / C transparentny
index = 1 pc / indeks = 1 szt.
76330000

C opal / C mleczny
index = 1 pc / indeks = 1 szt.
76330038



reel, length 20 m
package > check the pricelist
rolka, długość 20 m
opakowanie > patrz cennik

C opal / C mleczny
index = 1 pc / indeks = 1 szt.
76360038S



length 2000 mm
package > check the pricelist
długość 2000 mm
opakowanie > patrz cennik

C lens / C soczewka
index = 1 pc / indeks = 1 szt.
76300000

The standard cover length tolerance is +20 mm.
More details >> 1.08.

Standardowa tolerancja długości kloszy wynosi: +20 mm
Więcej informacji >> 1.08.

ENDINGS / ZAŚLEPKI

DEEP10 ending gen2 with hole
colours: white, silver, black, grey
material: ABS

zaślepka DEEP10 gen2 z otworem
kolory: biały, srebrny, czarny, szary
materiał: ABS

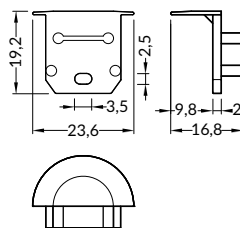

INDEX = 10 sets = 20 pcs
package > check the pricelist
INDEKS = 10 kpl = 20 szt.
opakowanie > patrz cennik

white / biały
96980001

silver / srebrny
96980040

black / czarny
96980002

grey / szary
96980022

DEEP10 ending gen2 SQ with hole
colours: white, silver, black, grey
material: ABS

zaślepka DEEP10 gen2 SQ z otworem
kolory: biały, srebrny, czarny, szary
materiał: ABS

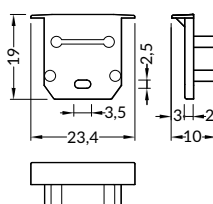

white / biały
96990001

silver / srebrny
96990040

black / czarny
96990002

grey / szary
96990022



CONNECTORS / ŁĄCZNIKI

X connector 180 deg
colour: raw aluminium
material: aluminium

łącznik X 180 st
kolor: surowe aluminium
materiał: aluminium

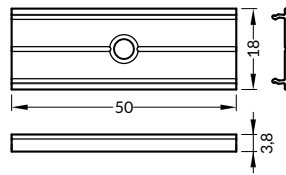

INDEX = 1 set
package > check the pricelist
INDEKS = 1 kpl
opakowanie > patrz cennik

raw aluminium
surowe aluminium
76350000

MOUNTINGS / MOCOWANIA

U flexible mounting plate
colour: inox
material: stainless steel

uchwyt U sprężysty
kolor: inox
materiał: stal nierdzewna

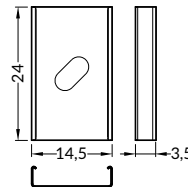
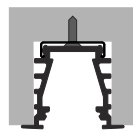

INDEX = 10 sets = 20 pcs
package > check the pricelist
INDEKS = 10 kpl = 20 szt.
opakowanie > patrz cennik

inox
76380000

cone U flexible mounting plate
colour: inox
material: stainless steel

uchwyt U sprężysty cone
kolor: inox
materiał: stal nierdzewna

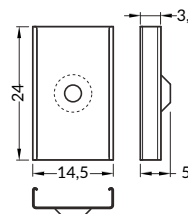

inox
76620000

rack U flexible mounting plate
colour: inox
material: stainless steel

uchwyt U sprężysty rack
kolor: inox
materiał: stal nierdzewna

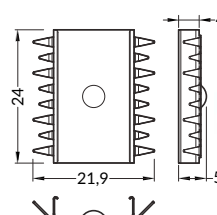

inox
76610019

X mounting plate
colour: raw aluminium
material: aluminium

uchwyt X
kolor: surowe aluminium
materiał: aluminium

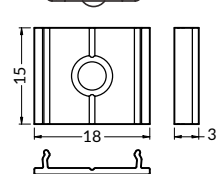

raw aluminium
surowe aluminium
76260000

spring X mounting plate
colour: raw aluminium
material: aluminium

uchwyt X sprężyna
kolor: surowe aluminium
materiał: aluminium

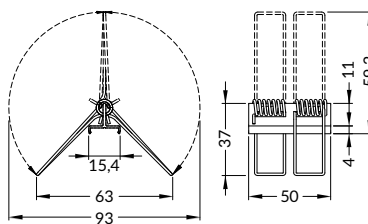

INDEX = 1 pc
package > check the pricelist
INDEKS = 1 szt.
opakowanie > patrz cennik

raw aluminium
surowe aluminium
23130000

GROOVE10 BC/UX

RECESSED ALUMINIUM PROFILE

ALUMINIOWY PROFIL WPUSTOWY

- used mainly in furniture
- ceiling installation possible
- 6 types of covers
- maximum LED strip width: 10 mm
- głównie do zastosowania meblowego
- możliwe zastosowanie sufitowe
- 6 rodzajów kloszy
- maksymalna szerokość taśmy LED: 10 mm



SIMILAR IN THE OFFER / PODOBNE W OFERCIE



DEEP10
BC/UX



TRIO10
BC



BEGTIN12
J/S



UNI12
BCD/U



GROOVE14
EF/TY



B slide cover
klosz B wsuwany

C click cover
klosz C klik

C lens cover
klosz C soczewka

U¹ U flexible mounting plate
uchwyt U sprężysty

U² cone U flexible mounting plate
uchwyt U sprężysty cone

U³ rack U flexible mounting plate
uchwyt U sprężysty rack

X¹ X mounting plate
uchwyt X

X² spring X mounting plate
uchwyt X sprężyna

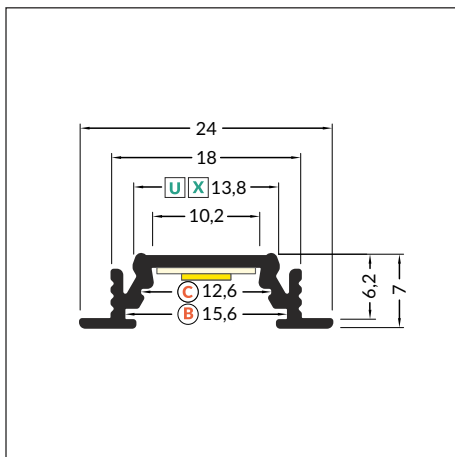
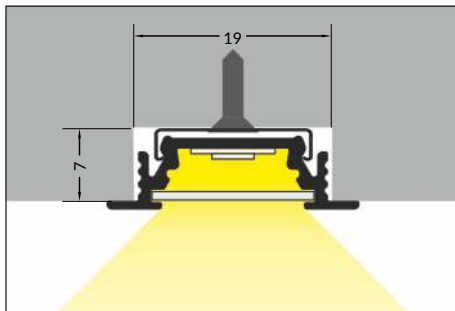
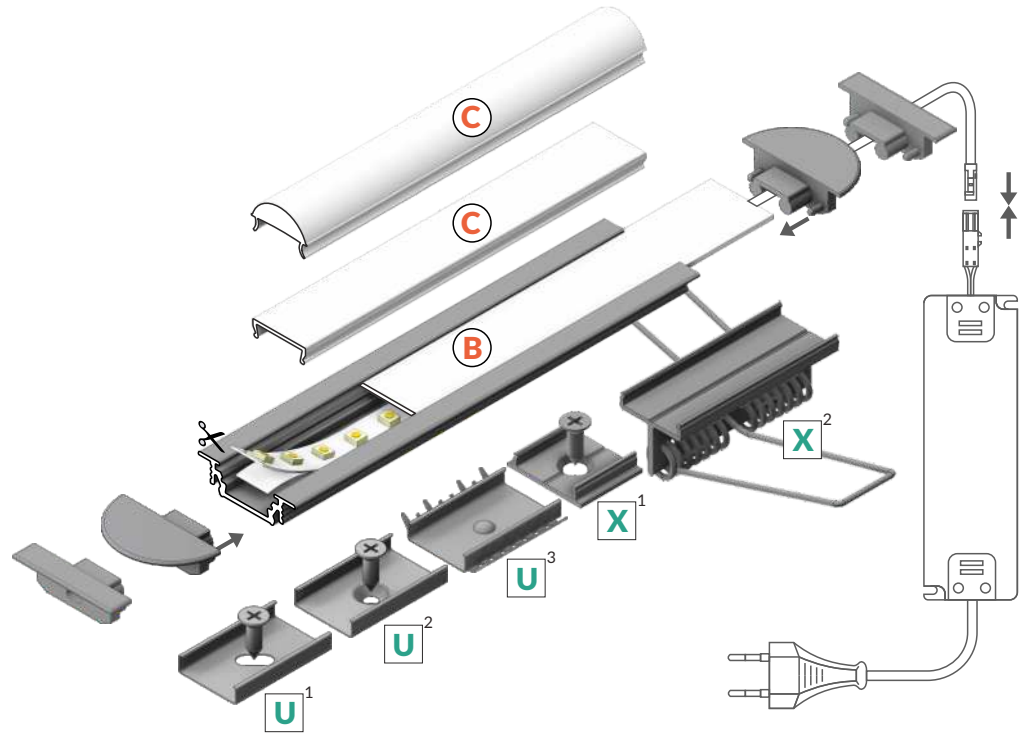

INDEX = 1 pc, length 2000 mm
package > check the pricelist
INDEKS = 1 szt., długość 2000 mm
opakowanie > patrz cennik

white painted
biały malowany
76210001



anodized
anodowany
76210020



black anodized
czarny anodowany
76210021



raw aluminium
surowe aluminium
76210000

Available lengths: 1000 mm, 2000 mm, 3000 mm, 4000 mm.
The standard profile length tolerance is +20 mm.
More details >> 1.08.

Dostępne długości: 1000 mm, 2000 mm, 3000 mm, 4000 mm.
Standardowa tolerancja długości profili wynosi: +20 mm.
Więcej informacji >> 1.08.

 max 10 mm

 recessed
wpustowy



COVERS / KLOSZE

B slide cover

colours: transparent, frosted, opal
material: PC, PP, PP

klosz B wsuwany
kolory: transparentny, szron, mleczny
materiał: PC, PP, PP

C click cover

colours: transparent, opal
material: PMMA

klosz C klik
kolory: transparentny, mleczny
materiał: PMMA

C click cover lens

colour: transparent
material: PC

klosz C klik soczewka
kolor: transparentny
materiał: PC



Note! Dimensions of the space needed to install LED source
Uwaga! Wymiary przestrzeni do zamontowania źródła LED

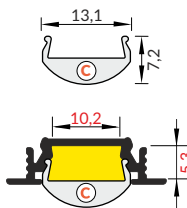
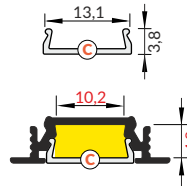
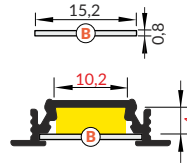

length 2000 mm
package > check the pricelist
długość 2000 mm
opakowanie > patrz cennik

B transparent / B transparentny
index = 10 pcs / indeks = 10 szt.
76250016

B frosted / B szron
index = 10 pcs / indeks = 10 szt.
76250039

B opal / B mleczny
index = 10 pcs / indeks = 10 szt.
76250038

C transparent / C transparentny
index = 1 pc / indeks = 1 szt.
76330000

C opal / C mleczny
index = 1 pc / indeks = 1 szt.
76330038

NEW



reel, length 20 m
package > check the pricelist
rolka, długość 20 m
opakowanie > patrz cennik

C opal / C mleczny
index = 1 pc / indeks = 1 szt.
76360038S



length 2000 mm
package > check the pricelist
długość 2000 mm
opakowanie > patrz cennik

C lens / C soczewka
index = 1 pc / indeks = 1 szt.
76300000

The standard cover length tolerance is +20 mm.
More details >> 1.08.

Standardowa tolerancja długości kloszy wynosi: +20 mm
Więcej informacji >> 1.08.

MOUNTINGS / MOCOWANIA

U flexible mounting plate

colour: inox
material: stainless steel

uchwyt U sprężysty
kolor: inox
materiał: stal nierdzewna

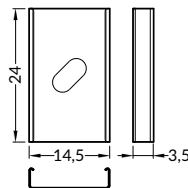
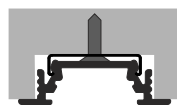

cone U flexible mounting plate

colour: inox
material: stainless steel

uchwyt U sprężysty cone
kolor: inox
materiał: stal nierdzewna

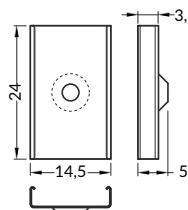
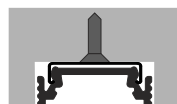

rack U flexible mounting plate

colour: inox
material: stainless steel

uchwyt U sprężysty rack
kolor: inox
materiał: stal nierdzewna

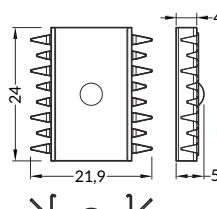

INDEX = 10 sets = 20 pcs
package > check the pricelist
INDEKS = 10 kpl = 20 szt.
opakowanie > patrz cennik

inox
76380000

inox
76620000

inox
76610019



X mounting plate
colour: raw aluminium
material: aluminium

uchwyt X
kolor: surowe aluminium
materiał: aluminium

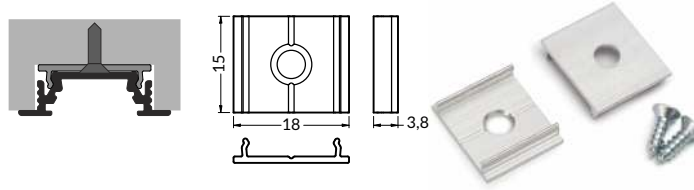

INDEX = 10 sets = 20 pcs
package > check the pricelist
INDEKS = 10 kpl = 20 szt.
opakowanie > patrz cennik

raw aluminium
surowe aluminium
76260000

spring X mounting plate
colour: raw aluminium
material: aluminium

uchwyt X sprężyna
kolor: surowe aluminium
materiał: aluminium

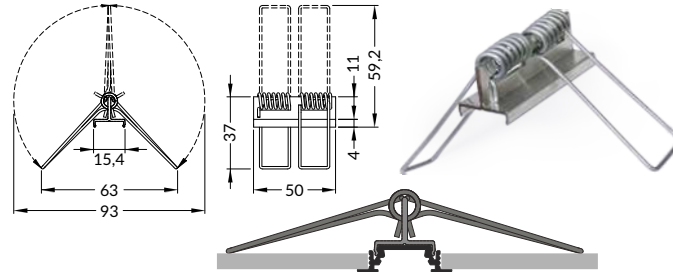

INDEX = 1 pc
package > check the pricelist
INDEKS = 1 szt.
opakowanie > patrz cennik

raw aluminium
surowe aluminium
23130000

ENDINGS / ZAŚLEPKI

GROOVE10 ending gen2 with hole
colours: white, silver, black, grey
material: ABS

zaślepka GROOVE10 gen2 z otworem
kolory: biały, srebrny, czarny, szary
materiał: ABS

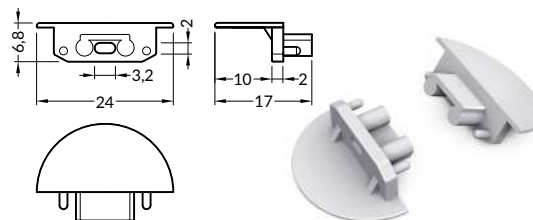

INDEX = 10 sets = 20 pcs
package > check the pricelist
INDEKS = 10 kpl = 20 szt.
opakowanie > patrz cennik

white / biały
76980001
silver / srebrny
76980004
black / czarny
76980002
grey / szary
76980022

GROOVE10 ending gen2 SQ with hole
colours: white, silver, black, grey
material: ABS

zaślepka GROOVE10 gen2 SQ z otworem
kolory: biały, srebrny, czarny, szary
materiał: ABS

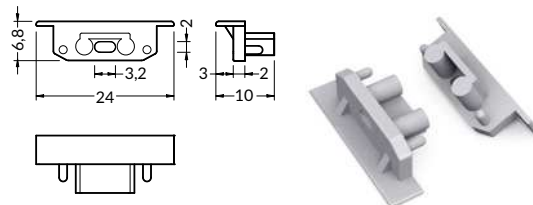

white / biały
76990001
silver / srebrny
76990004
black / czarny
76990002
grey / szary
76990022

CONNECTORS / ŁĄCZNIKI

X connector 180 deg
colour: raw aluminium
material: aluminium

łącznik X 180 st
kolor: surowe aluminium
materiał: aluminium

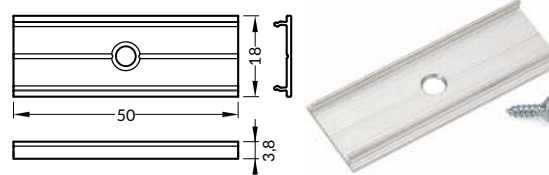

INDEX = 1 set
package > check the pricelist
INDEKS = 1 kpl
opakowanie > patrz cennik

raw aluminium
surowe aluminium
76350000

GROOVE10 connector 90 deg
colours: white, anodized, black
material: aluminium

łącznik GROOVE10 90 st
kolory: biały, anodowany, czarny
materiał: aluminium

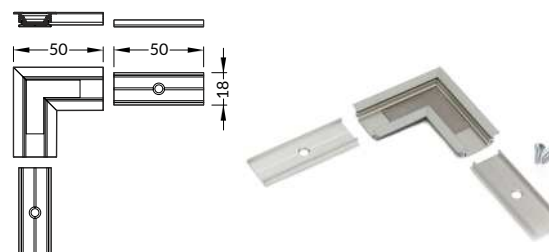

INDEX = 1 set
package > check the pricelist
INDEKS = 1 kpl
opakowanie > patrz cennik

white painted
biały malowany
76530001
anodized
anodowany
76530020
black anodized
czarny anodowany
76530021



SMART-IN10 AC2/Z



CONTINUOUS LIGHT LINE IN SMALL RECESSED PROFILE

CIĄGŁA LINIA ŚWIATŁA W MAŁYM PROFILU WPUSTOWYM

- suitable for use in plasterboards - does not affect the structure of the board
 - used also in furniture
 - continuous line of light (when using LED strip 120 p/m and opal cover)
 - SLICK socket
 - miniature dimensions
 - maximum width of LED strip: 10 mm
-
- do zastosowania w płycie gipsowo-kartonowej - nie narusza konstrukcji płyty
 - również do zastosowania meblowego
 - ciągła linia światła (przy zastosowaniu taśmy 120 P/m i klosza mlecznego)
 - gniazdo Slick
 - miniaturowe gabaryty
 - maksymalna szerokość taśmy LED: 10 mm



SIMILAR IN THE OFFER / PODOBNE W OFERCIE



DEEP10
BC/UX



SMART10
AC2/Z



GROOVE10
BC/UX



BEGTIN12
J/S



UNI12
BCD/U



GROOVE14
EF/TY



A **A** slide cover
klosz **A** wsuwany

C2 **C2** click cover
klosz **C2** klik

Z¹ **Z** flexible mounting plate
uchwyt **Z** sprężysty

Z² **cone Z** flexible mounting plate
uchwyt **Z** sprężysty cone

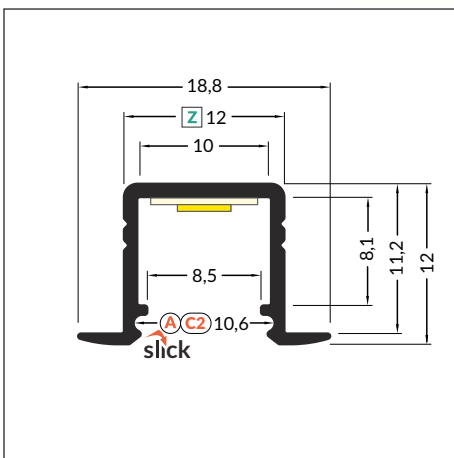
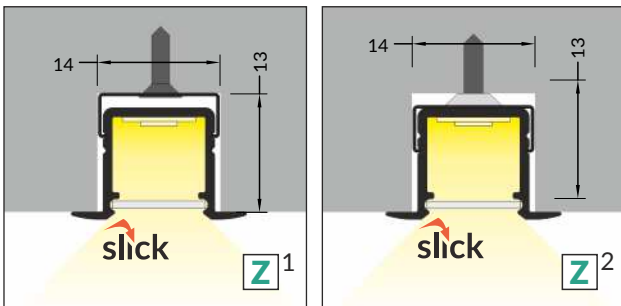
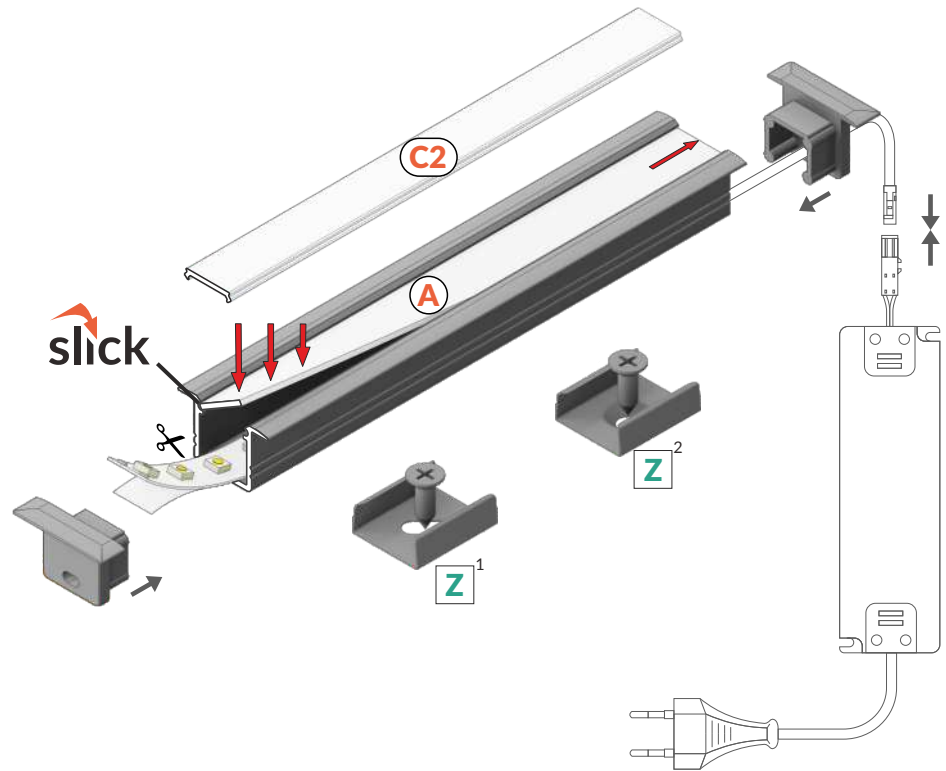

INDEX = 1 pc, length 2000 mm
package > check the pricelist
INDEKS = 1 szt., długość 2000 mm
opakowanie > patrz cennik

white painted
biały malowany
E3020001

anodized
anodowany
E3020020

black anodized
czarny anodowany
E3020021

raw aluminium
surowe aluminium
E3020000

 max 10 mm

 recessed
wpustowy

Available lengths: 1000 mm, 2000 mm, 3000 mm, 4000 mm.
The standard profile length tolerance is +20 mm.
More details >> 1.08.

Dostępne długości: 1000 mm, 2000 mm, 3000 mm, 4000 mm.
Standardowa tolerancja długości profilu wynosi: +20 mm.
Więcej informacji >> 1.08.



COVERS / KLOSZE

A slide cover

colours: transparent, frosted, opal
material: PC, PP, PP

klosz A wsuwany
kolory: transparentny, szron, mleczny
materiał: PC, PP, PP



Note! Dimensions of the space to install LED source
Uwaga! Wymiary przestrzeni do zamontowania źródła LED

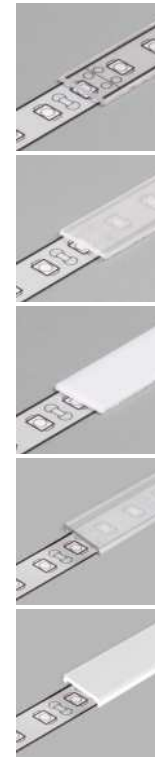
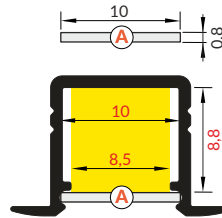

length 2000 mm
package > check the pricelist
długość 2000 mm
opakowanie > patrz cennik

A transparent / A transparentny
index = 10 pcs / indeks = 10 szt.

89070016

A frosted / A szron
index = 10 pcs / indeks = 10 szt.

89070039

A opal / A mleczny
index = 10 pcs / indeks = 10 szt.

89070038

C2 transparent
C2 transparentny
index = 1 pc / indeks = 1 szt.

89000216

C2 opal / C2 mleczny
index = 1 pc / indeks = 1 szt.

89000238

The standard cover length tolerance is +20 mm.
More details >> 1.08.

Standardowa tolerancja długości klosza wynosi: +20 mm
Więcej informacji >> 1.08.

C2 click cover

colours: transparent, opal
material: PMMA

NEW

klosz C2 klik
kolory: transparentny, mleczny
materiał: PMMA

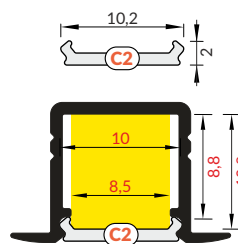

ENDINGS / ZAŚLEPKI

SMART-IN10 ending with hole
colours: white, silver, black, grey
material: ABS

zaślepka SMART-IN10 z otworem
kolory: biały, srebrny, czarny, szary
materiał: ABS

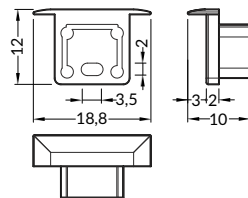

INDEX = 10 sets = 20 pcs
package > check the pricelist
INDEKS = 10 kpl = 20 szt.
opakowanie > patrz cennik

white / biały
E3990001

silver / srebrny
E3990040

black / czarny
E3990002

grey / szary
E3990022

MOUNTINGS / MOCOWANIA

Z flexible mounting plate
colours: white, inox, black
material: stainless steel

uchwyt Z sprężysty
kolory: biały, inox, czarny
materiał: stal nierdzewna

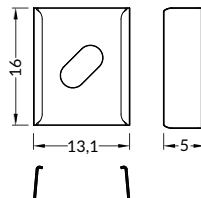
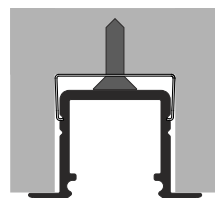

INDEX = 10 sets = 20 pcs
package > check the pricelist
INDEKS = 10 kpl = 20 szt.
opakowanie > patrz cennik

white / biały
89270001

inox
89270019

black / czarny
89270002

cone Z flexible mounting plate
colours: white, inox, black
material: stainless steel

uchwyt Z sprężysty cone
kolory: biały, inox, czarny
materiał: stal nierdzewna

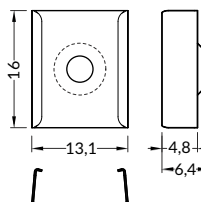
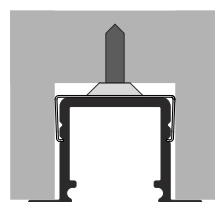

white / biały
89980001

inox
89980019

black / czarny
89980002



BEGTIN12 J/S



SMALL RECESSED ALUMINIUM PROFILE

MAŁY ALUMINIOWY PROFIL WPUSTOWY

- light weight, budget profile
- used mainly in furniture
- Slick socket
- maximum LED strip width: 12 mm

- lekki profil budżetowy
- głównie do zastosowania meblowego
- gniazdo z funkcją Slick
- maksymalna szerokość taśmy LED: 12 mm



SIMILAR IN THE OFFER / PODOBNE W OFERCIE



DEEP10
BC/UX



GROOVE10
BC/UX



SMART-IN10
AC2/Z



BEGTIN12
J/S



J slide cover
klosz J wsuwany

S¹ flexible mounting plate
uchwyt S sprężysty

S² cone S flexible mounting plate
uchwyt S sprężysty cone

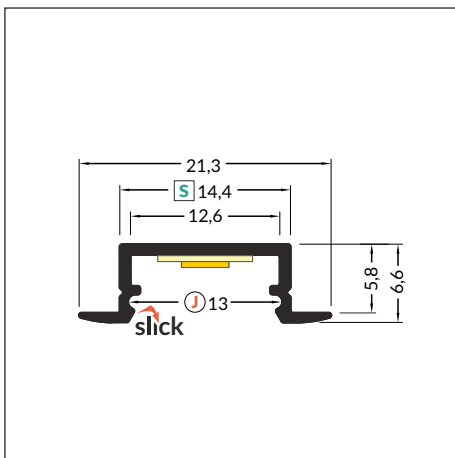
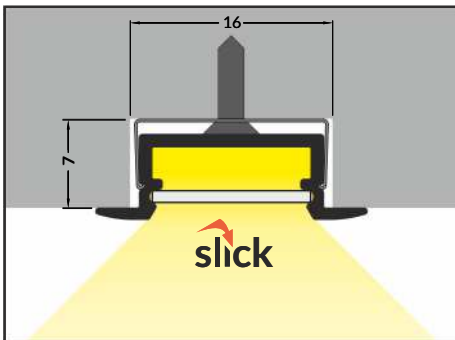
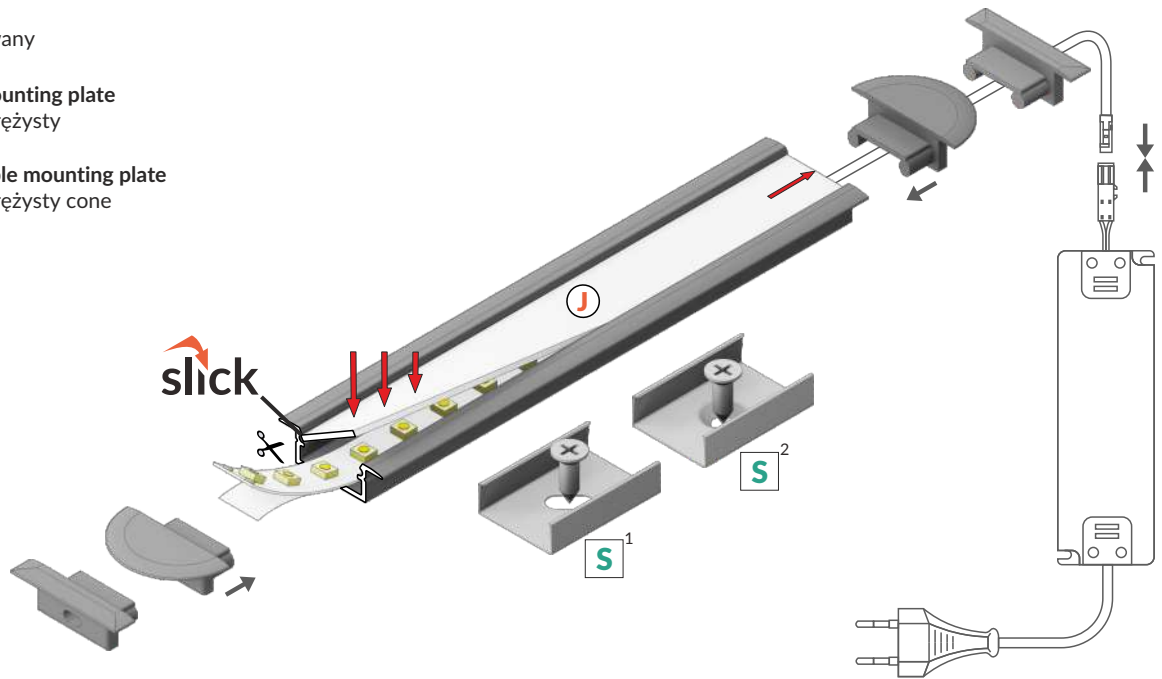

 max 12 mm

 recessed
wpustowy



INDEX = 1 pc, length 2000 mm
package > check the pricelist
INDEKS = 1 szt., długość 2000 mm
opakowanie > patrz cennik

white painted
biały malowany
C8020001



anodized
anodowany
C8020020



black anodized
czarny anodowany
C8020021



raw aluminium
surowe aluminium
C8020000

Available lengths: 1000 mm, 2000 mm, 3000 mm, 4000 mm.
The standard profile length tolerance is +20 mm.
More details >> 1.08.

Dostępne długości: 1000 mm, 2000 mm, 3000 mm, 4000 mm.
Standardowa tolerancja długości profilu wynosi: +20 mm.
Więcej informacji >> 1.08.



COVERS / KLOSZE

J slide cover

colours: transparent, frosted, opal
material: PC, PP, PP

klosz J wsuwany
kolory: transparentny, szron, mleczny
materiał: PC, PP, PP



Note! Dimensions of the space to install LED source
Uwaga! Wymiary przestrzeni do zamontowania źródła LED

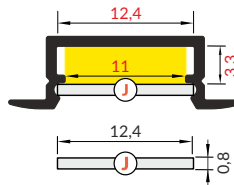

length 2000 mm
package > check the pricelist
długość 2000 mm
opakowanie > patrz cennik

J transparent / J transparentny
index = 10 pcs / indeks = 10 szt.

70330016

J frosted / J szron
index = 10 pcs / indeks = 10 szt.

70330039

J opal / J mleczny
index = 10 pcs / indeks = 10 szt.

70330038

The standard cover length tolerance is +20 mm.
More details >> 1.08.

Standardowa tolerancja długości kloszy wynosi: +20 mm
Więcej informacji >> 1.08.

ENDINGS / ZAŚLEPKI

BEGTIN12 ending gen2 with hole
colours: white, silver, black, grey
material: ABS

zaślepka BEGTIN12 gen2 z otworem
kolory: biały, srebrny, czarny, szary
materiał: ABS

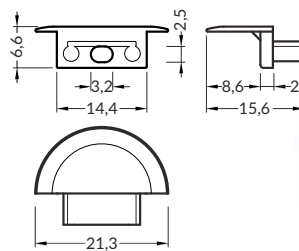

BEGTIN12 ending gen2 SQ with hole
colours: white, silver, black, grey
material: ABS

zaślepka BEGTIN12 gen2 SQ z otworem
kolory: biały, srebrny, czarny, szary
materiał: ABS

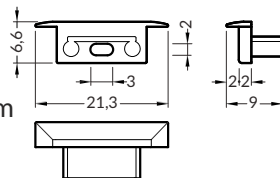

INDEX = 10 sets = 20 pcs
package > check the pricelist
INDEKS = 10 kpl = 20 szt.
opakowanie > patrz cennik

white / biały
C8980001

silver / srebrny
C8980040

black / czarny
C8980002

grey / szary
C8980022

white / biały
C8970001

silver / srebrny
C8970040

black / czarny
C8970002

grey / szary
C8970022

MOUNTINGS / MOCOWANIA

S flexible mounting plate
colours: white, inox, black
material: stainless steel

uchwyt S sprężysty
kolory: biały, inox, czarny
materiał: stal nierdzewna

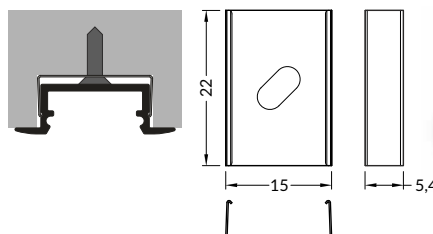

INDEX = 10 sets = 20 pcs
package > check the pricelist
INDEKS = 10 kpl = 20 szt.
opakowanie > patrz cennik

white / biały
C7980001

inox
C7980019

black / czarny
C7980002

cone S flexible mounting plate
colours: white, inox, black
material: stainless steel

uchwyt S sprężysty cone
kolory: biały, inox, czarny
materiał: stal nierdzewna

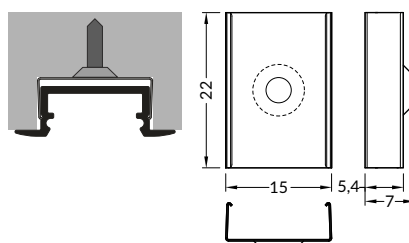

white / biały
C7950001

inox
C7950019

black / czarny
C7950002



FLOOR K

RECESSED FLOOR PROFILES

PROFILE WPUSTOWE DO PODŁÓG

- high abrasion resistance, resistant cover
- possibility of waterproof
- with high humidity, please use waterproof tape

- wysoka odporność na ścieranie, wytrzymały klosz
- możliwość uzyskania wodoszczelności
- przy podwyższonej wilgotności stosować taśmę wodoodporną



SIMILAR IN THE OFFER / PODOBNE W OFERCIE



STEP10
C



DEEP10
BC/UX



UNI12
BCD/U



UNI-TILE12
90 deg C



UNI-TILE12
180 deg C



UNI-TILE12
270 deg C



FLOOR8 K

NEW

Optimal height
for installation
in standard tiles
or floor panels _____ > 3.31

Optymalna wysokość
do montażu w standardowych
płytkach lub panelach
podłogowych _____ > 3.31



max 8 mm



for continuous
line of light
dla ciągłej linii światła

FLOOR12 K/U

The perfect solution
for application
in thicker floor
materials _____ > 3.33

Rozwiązanie idealne
do stosowania
w grubszych materiałach
podłogowych _____ > 3.33



max 12 mm



for continuous
line of light
dla ciągłej linii światła

K click cover
klosz K klik

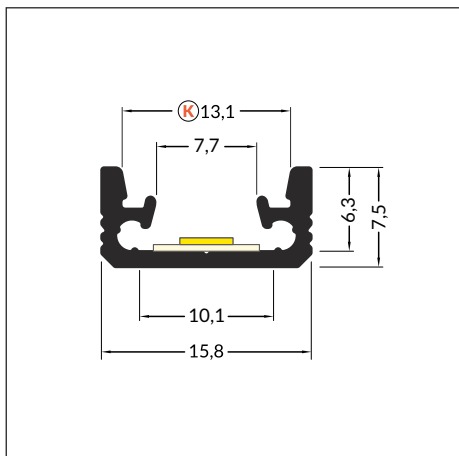
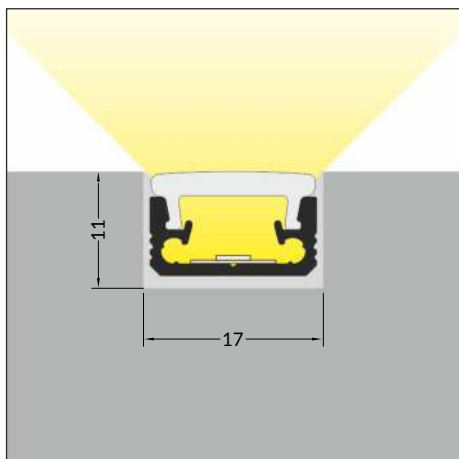
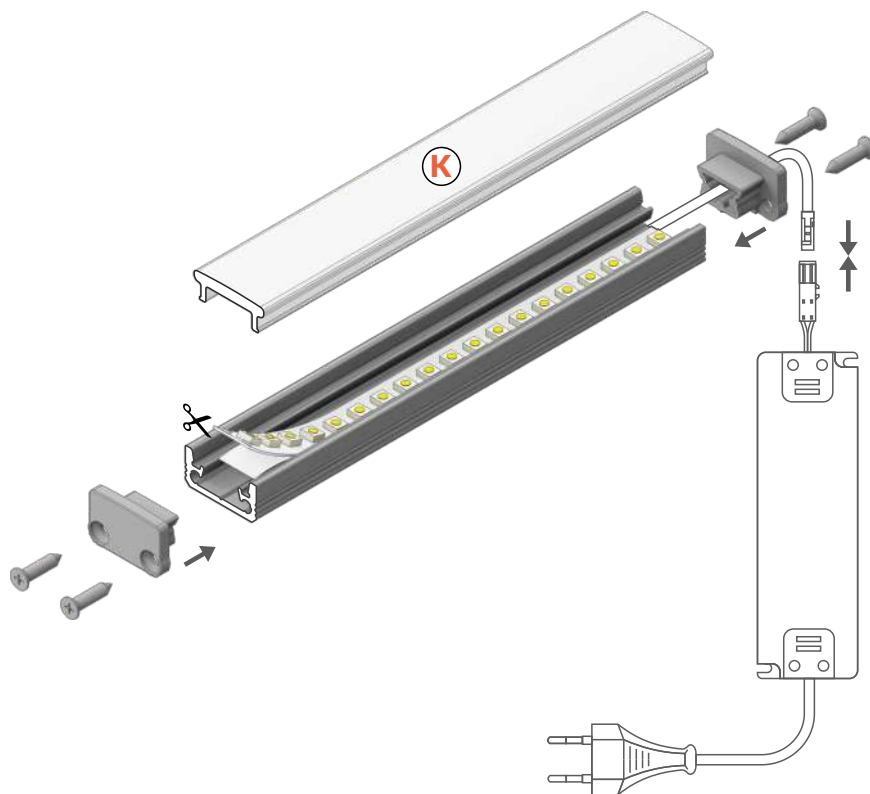

INDEX = 1 pc, length 2000 mm
package > check the pricelist
INDEKS = 1 szt., długość 2000 mm
opakowanie > patrz cennik

anodized
anodowany
G6000220



Available lengths: 1000 mm, 2000 mm, 3000 mm, 4000 mm.
The standard profile length tolerance is +20 mm.
More details >> 1.08.

Dostępne długości: 1000 mm, 2000 mm, 3000 mm, 4000 mm.
Standardowa tolerancja długości profili wynosi: +20 mm.
Więcej informacji >> 1.08.



max 8 mm



recessed
wpustowy



IK08 (5 J)



↓ 5 J





COVERS / KLOSZE

K click cover
colour: opal
material: PC

klosz **K** klik
kolor: mleczny
materiał: PC



Note! Dimensions of the space needed to install LED source
Uwaga! Wymiary przestrzeni do zamontowania źródła LED

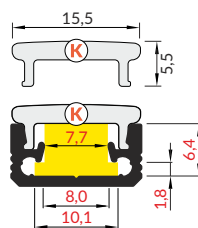

length 2000 mm
package > check the pricelist
długość 2000 mm
opakowanie > patrz cennik

K transparent / K transparentny
index = 1 pc / indeks = 1 szt.

B1040038

The standard cover length tolerance is +20 mm.
More details >> 1.08.
Standardowa tolerancja długości kloszy wynosi: +20 mm
Więcej informacji >> 1.08.

ENDINGS / ZAŚLEPKI

FLOOR8 ending
colours: silver, grey
material: ABS

zaślepka FLOOR8
kolory: srebrny, szary
materiał: ABS

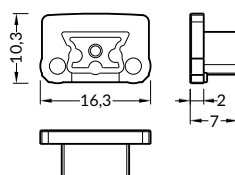

INDEX = 10 sets = 20 pcs
package > check the pricelist
INDEKS = 10 kpl = 20 szt.
opakowanie > patrz cennik

silver / srebrny
G6999940

grey / szary
G6999922

SEALING / USZCZELKA

sealings for FLOOR8 endings
2x silicone sealings
4x rubber o-ring

uszczelki do zaślepki FLOOR8
2x silikonowa uszczelka
4x gumowa uszczelka o-ring



In high humidity conditions
use waterproof tape and silicone seal
Przy podwyższonej wilgotności zaleca się
użycie zestawu uszczelniającego
i wodoodpornej taśmy.



INDEX = 1 set
package > check the pricelist
INDEKS = 1 kpl
opakowanie > patrz cennik

G6999800S





- K** click cover
klosz K klik
- U¹** flexible mounting plate
uchwyt U sprężysty
- U²** cone U flexible mounting plate
uchwyt U sprężysty cone

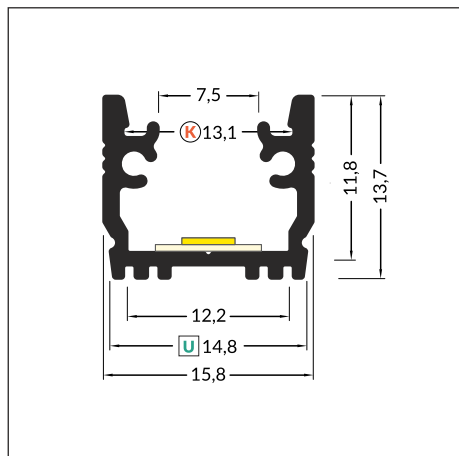
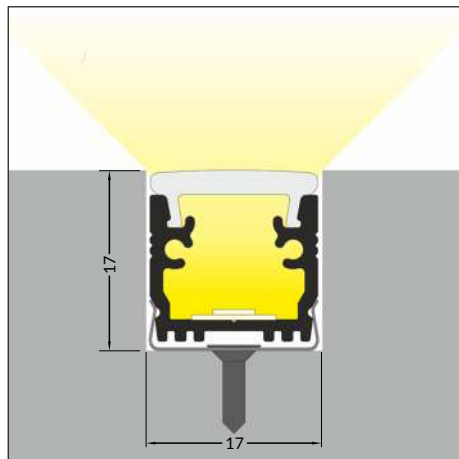
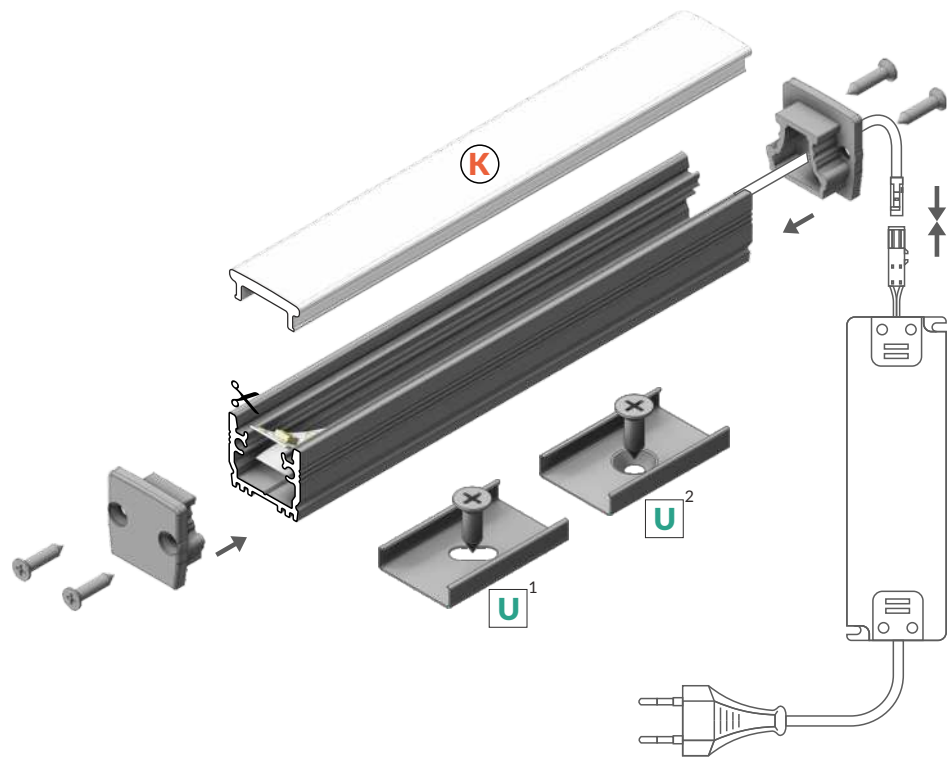

INDEX = 1 pc, length 2000 mm
package > check the pricelist
INDEKS = 1 szt., długość 2000 mm
opakowanie > patrz cennik



anodized
anodowany
B1020020

Available lengths: 1000 mm, 2000 mm, 3000 mm, 4000 mm.
The standard profile length tolerance is +20 mm.
More details >> 1.08.

Dostępne długości: 1000 mm, 2000 mm, 3000 mm, 4000 mm.
Standardowa tolerancja długości profili wynosi: +20 mm.
Więcej informacji >> 1.08.

-  max 12 mm
-  recessed
wpustowy
-  IK08 (5 J)

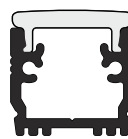



COVERS / KLOSZE

K click cover
colour: opal
material: PC

klosz **K** klik
kolor: mleczny
materiał: PC



Note! Dimensions of the space needed to install LED source
Uwaga! Wymiary przestrzeni do zamontowania źródła LED

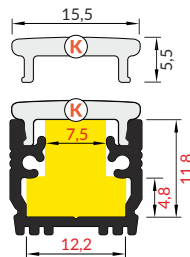

length 2000 mm
package > check the pricelist
długość 2000 mm
opakowanie > patrz cennik

K transparent / K transparentny
index = 1 pc / indeks = 1 szt.
B1040038

The standard cover length tolerance is +20 mm.
More details >> 1.08.
Standardowa tolerancja długości kloszy wynosi: +20 mm
Więcej informacji >> 1.08.

ENDINGS / ZAŚLEPKI

FLOOR12 ending
colours: silver, grey
material: ABS

zaślepka FLOOR12
kolory: srebrny, szary
materiał: ABS

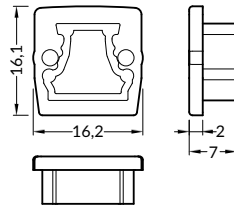

FLOOR12 ending with hole
colours: silver, grey
material: ABS

zaślepka FLOOR12 z otworem
kolory: srebrny, szary
materiał: ABS

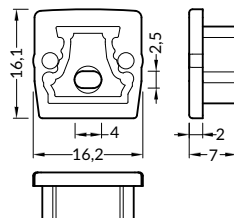

INDEX = 10 sets = 20 pcs
package > check the pricelist
INDEKS = 10 kpl = 20 szt.
opakowanie > patrz cennik

silver / srebrny
B1940040

grey / szary
B1940022

silver / srebrny
B1960040

grey / szary
B1960022

MOUNTINGS / MOCOWANIA

U flexible mounting plate
colour: inox
material: stainless steel

uchwyt **U** sprężysty
kolor: inox
materiał: stal nierdzewna

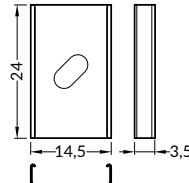
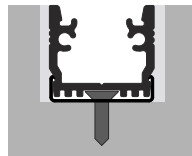

INDEX = 10 sets = 20 pcs
package > check the pricelist
INDEKS = 10 kpl = 20 szt.
opakowanie > patrz cennik

inox
76380000

cone U flexible mounting plate
colour: inox
material: stainless steel

uchwyt **U** sprężysty cone
kolor: inox
materiał: stal nierdzewna

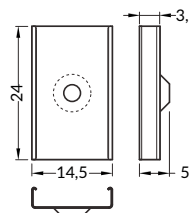
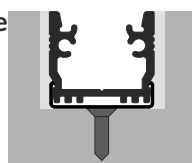

inox
76620000

INDEX = 1 set
package > check the pricelist
INDEKS = 1 kpl
opakowanie > patrz cennik

B1830000

SEALING / USZCZELKA

sealings for FLOOR12 endings
2x silicone sealings
4x rubber o-ring

uszczelki do zaślepki FLOOR12
2x silikonowa uszczelka
4x gumowa uszczelka o-ring



In high humidity conditions
use waterproof tape and silicone seal
Przy podwyższonej wilgotności zaleca się
użycie zestawu uszczelniającego
i wodoodpornej taśmy.



GROOVE14 EF/TY

BASIC ALUMINIUM RECESSED PROFILE

PODSTAWOWY, ALUMINIOWY PROFIL WPUSTOWY

- used mainly in furniture
- maximum LED strip width: 14 mm
- głównie do zastosowania meblowego
- maksymalna szerokość taśmy LED: 14 mm



SIMILAR IN THE OFFER / PODOBNE W OFERCIE



DEEP10
BC/UX



GROOVE10
BC/UX



TRIO10
BC



UNI12
BCD/U



E slide cover
klosz E wsuwany

F click cover
klosz F klik

E7 click cover
klosz E7 klik

Y¹ flexible mounting plate
uchwyt Y sprężysty

Y² cone Y flexible mounting plate
uchwyt Y sprężysty cone

T mounting plate
uchwyt T

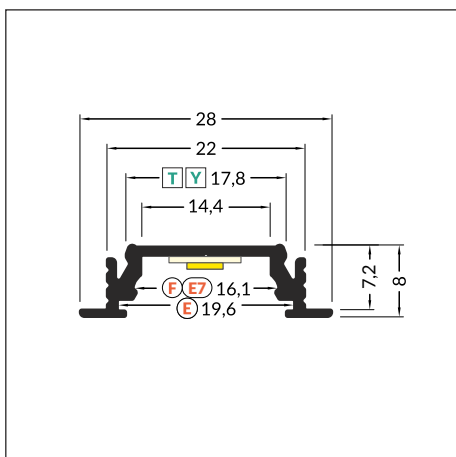
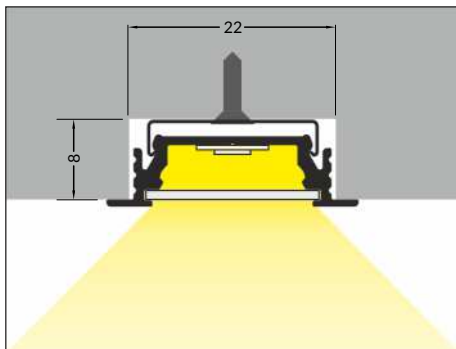
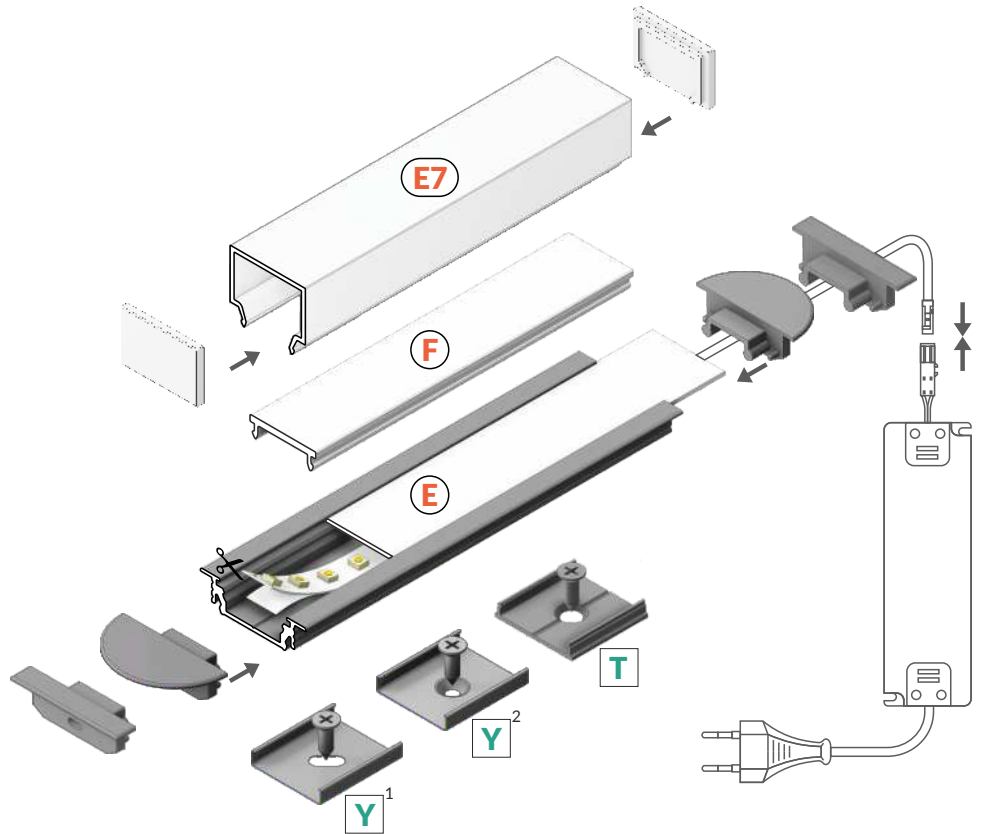

 max 14 mm

 recessed
wpustowy

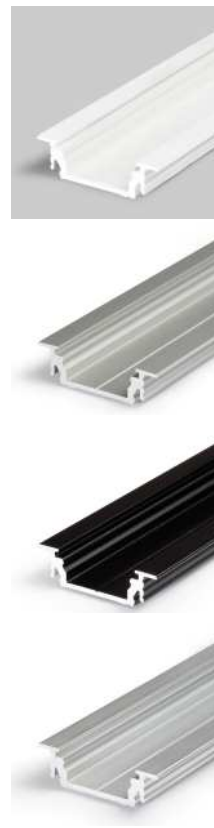

INDEX = 1 pc, length 2000 mm
package > check the pricelist
INDEKS = 1 szt., długość 2000 mm
opakowanie > patrz cennik

white painted
biały malowany
A3020001

anodized
anodowany
A3020020

black anodized
czarny anodowany
A3020021

raw aluminium
surowe aluminium
A3020000

Available lengths: 1000 mm, 2000 mm, 3000 mm, 4000 mm.
The standard profile length tolerance is +20 mm.
More details >> 1.08.

Dostępne długości: 1000 mm, 2000 mm, 3000 mm, 4000 mm.
Standardowa tolerancja długości profili wynosi: +20 mm.
Więcej informacji >> 1.08.



COVERS / KLOSZE

E slide cover

colours: transparent, frosted, opal
material: PC, PP, PP

klosz E wsuwany
kolory: transparentny, szron, mleczny
materiał: PC, PP, PP



Note! Dimensions of the space to install LED source
Uwaga! Wymiary przestrzeni do zamontowania źródła LED

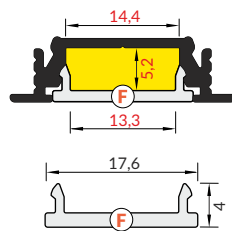
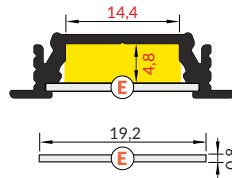

F click cover

colours: transparent, opal
material: PMMA

klosz F klik
kolory: transparentny, mleczny
materiał: PMMA

E7 click cover

colour: opal
material: PMMA

klosz E7 klik
kolor: mleczny
materiał: PMMA

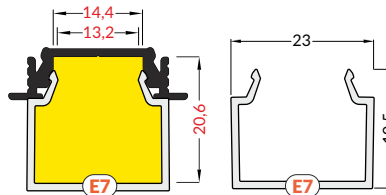

NEW

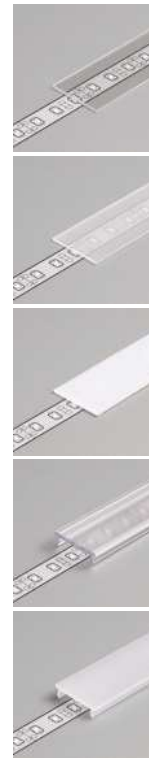

length 2000 mm
package > check the pricelist
długość 2000 mm
opakowanie > patrz cennik

E transparent / E transparentny
index = 10 pcs / indeks = 10 szt.

A2040016

E frosted / E szron
index = 10 pcs / indeks = 10 szt.

A2040039

E opal / E mleczny
index = 10 pcs / indeks = 10 szt.

A2040038

F transparent / F transparentny
index = 1 pc / indeks = 1 szt.

A2060016

F opal / F mleczny
index = 1 pc / indeks = 1 szt.

A2060038



reel, length 20 m
package > check the pricelist
rolka, długość 20 m
opakowanie > patrz cennik

F opal / F mleczny
index = 1 pc / indeks = 1 szt.

A2210038S



length 2000 mm
package > check the pricelist
długość 2000 mm
opakowanie > patrz cennik

E7 opal / E7 mleczny
index = 1 pc / indeks = 1 szt.

C1080038

The standard cover length tolerance is +20 mm.
More details >> 1.08.

Standardowa tolerancja długości kloszy wynosi: +20 mm
Więcej informacji >> 1.08.

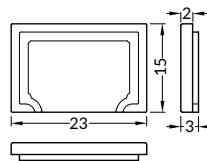

INDEX = 1 set = 2 pcs
package > check the pricelist
INDEKS = 1 kpl = 2 szt.
opakowanie > patrz cennik

E7 opal ending
zaślepka E7 mleczny

C1840038

MOUNTINGS / MOCOWANIA

Y flexible mounting plate

colour: inox
material: stainless steel

uchwyt Y sprężysty
kolor: inox
materiał: stal nierdzewna

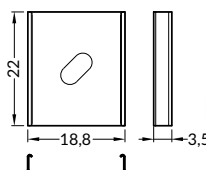
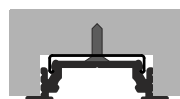

cone Y flexible mounting plate

colour: inox
material: stainless steel

uchwyt Y sprężysty cone
kolor: inox
materiał: stal nierdzewna

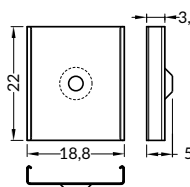
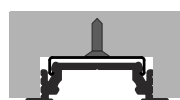

INDEX = 10 sets = 20 pcs
package > check the pricelist
INDEKS = 10 kpl = 20 szt.
opakowanie > patrz cennik

inox
A2090019

inox
A2130019



MOUNTINGS / MOCOWANIA

T mounting plate
colour: raw aluminium
material: aluminium

uchwyt **T**
kolor: surowe aluminium
materiał: aluminium

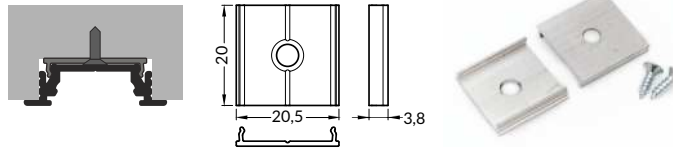

INDEX = 10 sets = 20 pcs
package > check the pricelist
INDEKS = 10 kpl = 20 szt.
opakowanie > patrz cennik

raw aluminium
surowe aluminium
C6960000

ENDINGS / ZAŚLEPKI

GROOVE14 ending gen2 with hole
colours: white, silver, black, grey
material: ABS

zaślepka GROOVE14 gen2 z otworem
kolory: biały, srebrny, czarny, szary
materiał: ABS

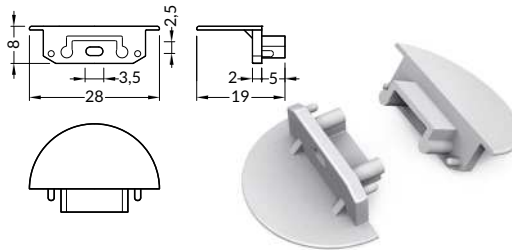

INDEX = 10 sets = 20 pcs
package > check the pricelist
INDEKS = 10 kpl = 20 szt.
opakowanie > patrz cennik

white / biały
A3970001
silver / srebrny
A3970040
black / czarny
A3970002
grey / szary
A3970022

GROOVE14 ending gen2 SQ with hole
colours: white, silver, black, grey
material: ABS

zaślepka GROOVE14 gen2 SQ z otworem
kolory: biały, srebrny, czarny, szary
materiał: ABS

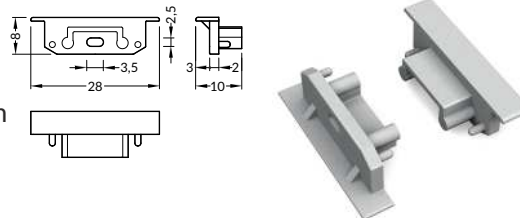

white / biały
A3980001
silver / srebrny
A3980040
black / czarny
A3980002
grey / szary
A3980022

CONNECTORS / ŁĄCZNIKI

T connector 180 deg
colour: raw aluminium
material: aluminium

łącznik **T** 180 st
kolor: surowe aluminium
materiał: aluminium

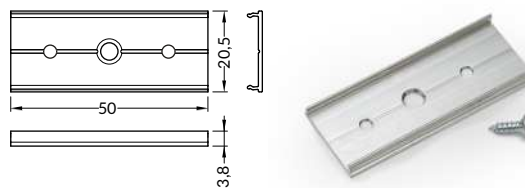

INDEX = 1 set, package > check the pricelist
INDEKS = 1 kpl, opakowanie > patrz cennik

raw aluminium
surowe aluminium
C6990000

GROOVE14 connector 90 deg
colours: white, anodized, black
material: aluminium

łącznik GROOVE14 90 st
kolory: biały, anodowany, czarny
materiał: aluminium

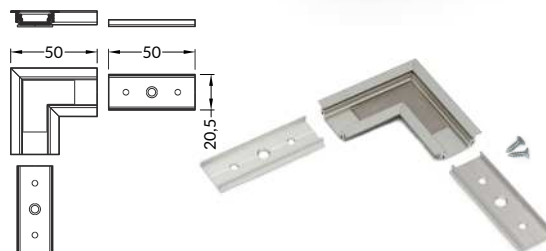

white painted
biały malowany
A3990001
anodized
anodowany
A3990020
black anodized
czarny anodowany
A3990021



SMART-IN16 BC3/U4

ECONOMICAL RECESSED PROFILE FOR 16 mm LED STRIP

EKONOMICZNY PROFIL WPUSTOWY DO TAŚM 16 mm

- SLICK socket - easy assembly technology
- various ways of mounting
- continuous line of light (when using LED strip 120 P/m and opal cover)
- maximum width of LED strip: 16 mm
- gniazdo SLICK - prosty montaż klosza
- rozmaite sposoby montażowe
- ciągła linia światła (przy zastosowaniu taśmy 120 P/m i klosza mlecznego)
- maksymalna szerokość taśmy LED: 16 mm



SIMILAR IN THE OFFER / PODOBNE W OFERCIE



SMART16
BC3/U4



SMART-IN10
AC2/Z



BEGTIN12
J/S



GROOVE14
EF/TY



LINEA-IN20
EF/U7

- B** slide cover
klosz B wsuwany
- C3** click cover
klosz C3 klik
- U4**¹ U4 mounting plate
uchwyt U4
- U4**² cone U4 mounting plate
uchwyt U4 cone
- U4**³ spring U4 mounting plate
uchwyt U4 sprężyna

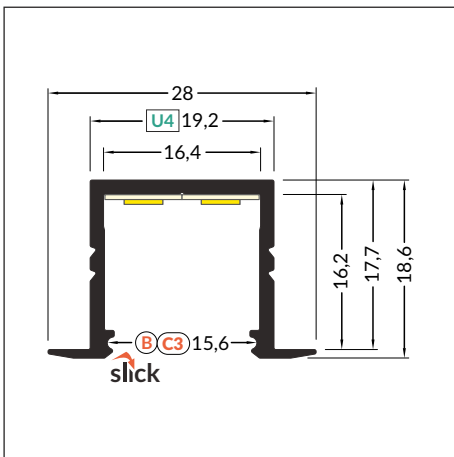
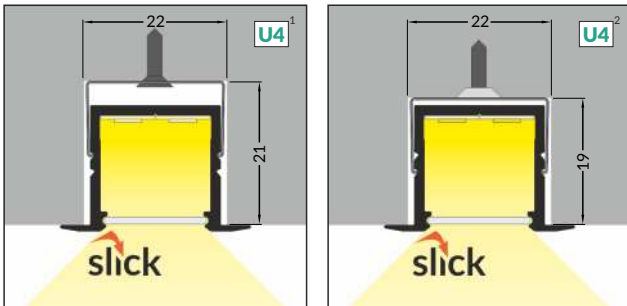
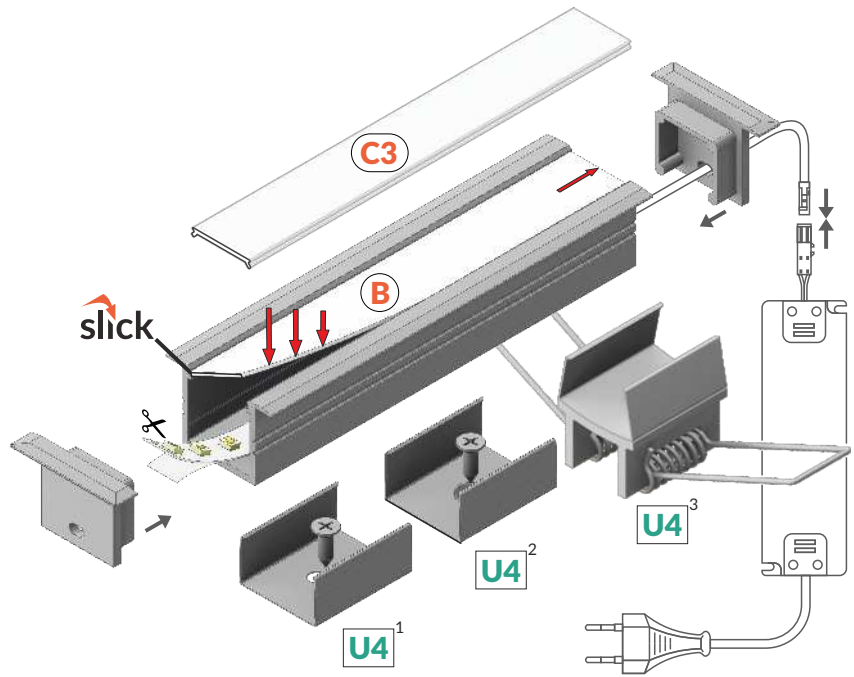

max 16 mm



recessed
wpustowy

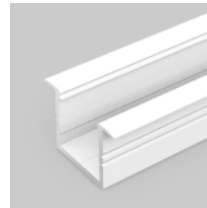

INDEX = 1 pc, length 2000 mm
package > check the pricelist
INDEKS = 1 szt., długość 2000 mm
opakowanie > patrz cennik

white painted / biały malowany
F6000201



anodized / anodowany
F6000220



raw aluminium / surowe aluminium
F6000200

Available lengths: 1000 mm, 2000 mm, 3000 mm, 4000 mm.
The standard profile length tolerance is +20 mm.
More details >> 1.08.

Dostępne długości: 1000 mm, 2000 mm, 3000 mm, 4000 mm.
Standardowa tolerancja długości profili wynosi: +20 mm.
Więcej informacji >> 1.08.



COVERS / KLOSZE

B slide cover
colours: transparent, frosted, opal
material: PC, PP, PP

klosz **B** wsuwany
kolory: transparentny, szron, mleczny
materiał: PC, PP, PP



Note! Dimensions of the space to install LED source
Uwaga! Wymiary przestrzeni do zamontowania źródła LED

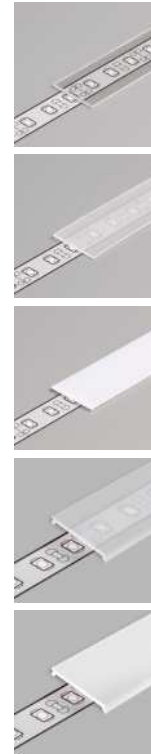
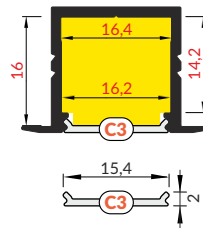
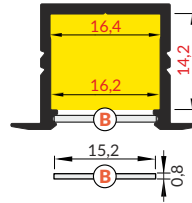

length 2000 mm
package > check the pricelist
długość 2000 mm
opakowanie > patrz cennik

B transparent / B transparentny
index = 10 pcs / indeks = 10 szt.

76250016

B frosted / B szron
index = 10 pcs / indeks = 10 szt.

76250039

B opal / B mleczny
index = 10 pcs / indeks = 10 szt.

76250038

C3 transparent / C3 transparentny
index = 1 pc / indeks = 1 szt.

F1000216

C3 opal / C3 mleczny
index = 1 pc / indeks = 1 szt.

F1000238

The standard cover length tolerance is +20 mm.
More details >> 1.08.

Standardowa tolerancja długości kloszy wynosi: +20 mm
Więcej informacji >> 1.08.

C3 click cover
colours: transparent, opal **NEW**
material: PMMA

klosz **C3** klik
kolory: transparentny, mleczny
materiał: PMMA

ENDINGS / ZAŚLEPKI

SMART-IN16 ending with hole
colours: white, silver, black, grey
material: ABS

zaślepka SMART-IN16 z otworem
kolory: biały, srebrny, czarny, szary
materiał: ABS

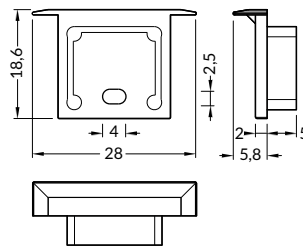

INDEX = 10 sets = 20 pcs
package > check the pricelist
INDEKS = 10 kpl = 20 szt.
opakowanie > patrz cennik

white / biały
F6009901

silver / srebrny
F6009940

grey / szary
F6009922

MOUNTINGS / MOCOWANIA

U4 mounting plate
colours: white, inox
material: stainless steel

uchwyt **U4**
kolory: biały, inox
materiał: stal nierdzewna

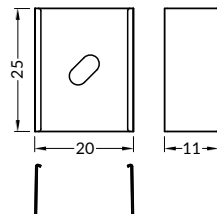

white / biały
F1970001

inox / inox
F1970019

cone U4 mounting plate
colours: white, inox
material: stainless steel

uchwyt **U4** cone
kolory: biały, inox
materiał: stal nierdzewna

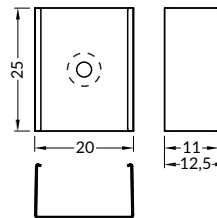

white / biały
F1980001

inox / inox
F1980019



MOUNTINGS / MOCOWANIA

spring **U4** mounting plate
colours: inox
material: stainless steel

uchwyt **U4** sprężyna
kolory: inox
materiał: stal nierdzewna

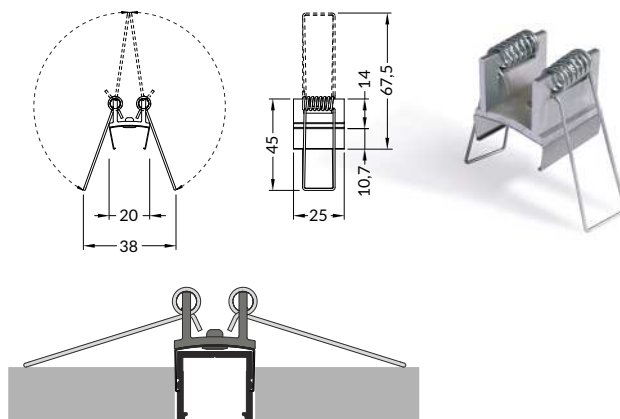

INDEX = 1 set = 2 pcs
package > check the pricelist
INDEKS = 1 kpl = 2 szt.
opakowanie > patrz cennik

inox / inox
F6009819S



LINEA-IN20 EF/U7

CREATING LIGHTING PATTERNS THANKS TO ANGULAR CONNECTORS

KSZTAŁTOWANIE WZORÓW ŚWIETLNYCH DZIĘKI ŁĄCZNIKOM KĄTOWYM

- continuous line of light (when using LED strip 120 P/m and opal cover)
- angled connections illuminated
- over 20 accessories available
- 3 mounting options of LED modules: thermic tape, LED module on a strip, additionally LED clamp
- maximum LED source width: 20 mm

- ciągła linia światła (przy użyciu taśm 120 P/m oraz klosza mlecznego)
- świecące połączenia kątowe
- ponad 20 akcesoriów
- 3 sposoby mocowania modułów LED: taśmą termiczną, moduł na taśmie, dodatkowo docisk LED
- maksymalna szerokość źródła LED: 20 mm

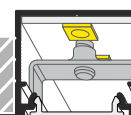

SIMILAR IN THE OFFER / PODOBNE W OFERCIE





- E** slide cover
klosz E wsuwany
- F** click cover
klosz F klik
- E7** click cover
klosz E7 klik
- U7**¹ U7 mounting plate
uchwyt U7
- U7**² cone U7 mounting plate
uchwyt U7 cone
- U7**³ rack U7 mounting plate
uchwyt U7 rack
- U7**⁴ spring U7 mounting plate
uchwyt U7 sprężyna

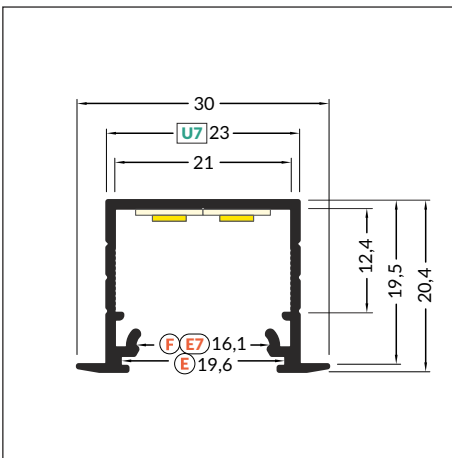
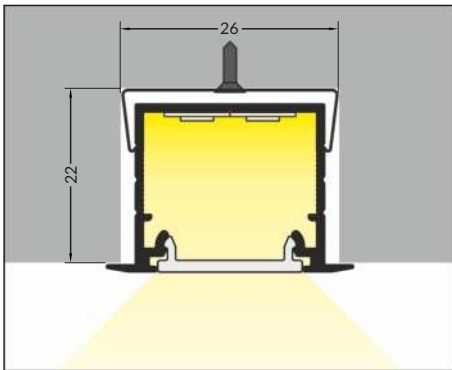
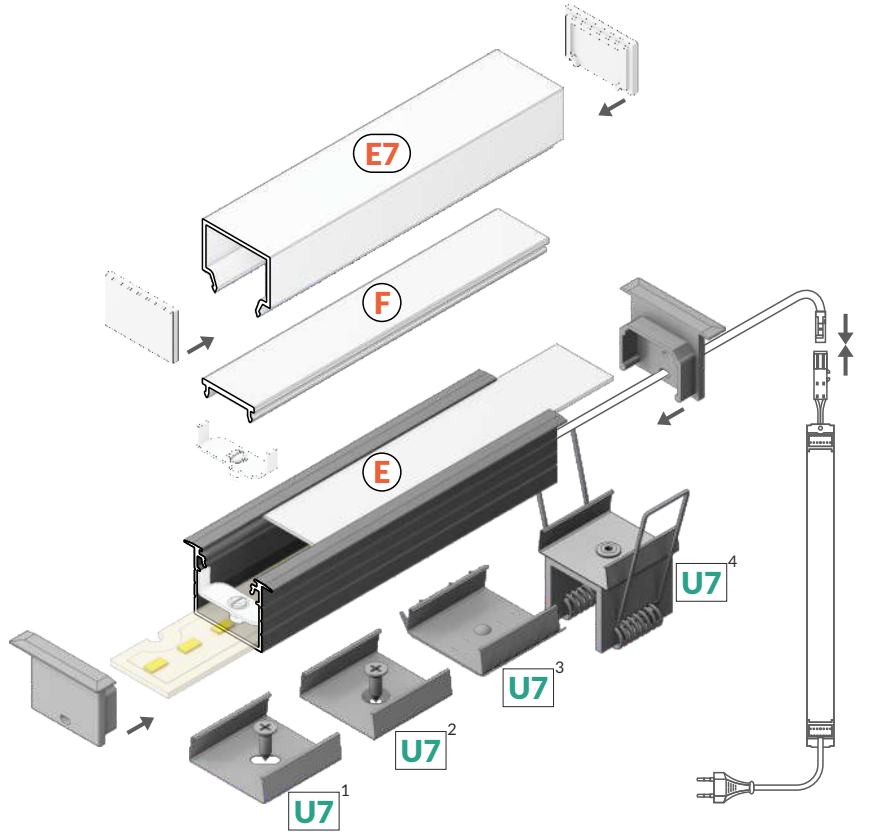

INDEX = 1 pc, length 2000 mm
package > check the pricelist
INDEKS = 1 szt., długość 2000 mm
opakowanie > patrz cennik

white painted
biały malowany
E4020001



anodized
anodowany
E4020020



black anodized
czarny anodowany
E4020021



raw aluminium
surowe aluminium
E4020000



max 20 mm



recessed
wpustowy

Available lengths: 1000 mm, 2000 mm, 3000 mm, 4000 mm.
The standard profile length tolerance is +20 mm.
More details >> 1.08.

Dostępne długości: 1000 mm, 2000 mm, 3000 mm, 4000 mm.
Standardowa tolerancja długości profili wynosi: +20 mm.
Więcej informacji >> 1.08.



COVERS / KLOSZE

E slide cover

colours: transparent, frosted, opal
material: PC, PP, PP

klosz E wsuwany
kolory: transparentny, szron, mleczny
materiał: PC, PP, PP



Note! Dimensions of the space to install LED source
Uwaga! Wymiary przestrzeni do zamontowania źródła LED

F click cover

colours: transparent, opal
material: PMMA

klosz F klik
kolory: transparentny, mleczny
materiał: PMMA

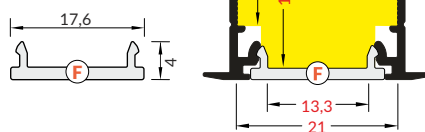

E7 click cover

colour: opal
material: PMMA

klosz E7 klik
kolor: mleczny
materiał: PMMA

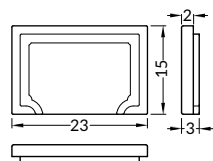
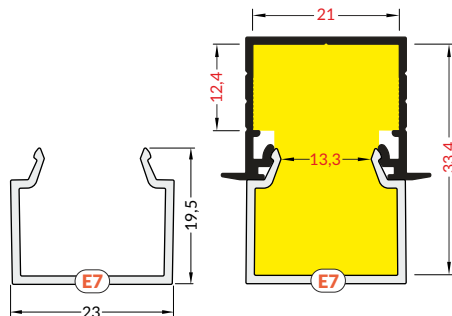

NEW



length 2000 mm
package > check the pricelist
długość 2000 mm
opakowanie > patrz cennik

E transparent / E transparentny
index = 10 pcs / indeks = 10 szt.

A2040016

E frosted / E szron
index = 10 pcs / indeks = 10 szt.

A2040039

E opal / E mleczny
index = 10 pcs / indeks = 10 szt.

A2040038

F transparent / F transparentny
index = 1 pc / indeks = 1 szt.

A2060016

F opal / F mleczny
index = 1 pc / indeks = 1 szt.

A2060038

reel, length 20 m
package > check the pricelist
rolka, długość 20 m
opakowanie > patrz cennik

F opal / F mleczny
index = 1 pc / indeks = 1 szt.

A2210038S

length 2000 mm
package > check the pricelist
długość 2000 mm
opakowanie > patrz cennik

E7 opal / E7 mleczny
index = 1 pc / indeks = 1 szt.

C1080038

The standard cover length tolerance is +20 mm.
More details >> 1.08.

Standardowa tolerancja długości kloszy wynosi: +20 mm
Więcej informacji >> 1.08.

INDEX = 1 set = 2 pcs
package > check the pricelist
INDEKS = 1 kpl = 2 szt.
opakowanie > patrz cennik

E7 opal ending
zaślepka E7 mleczny

C1840038

ENDINGS / ZAŚLEPKI

LINEA-IN20 ending with hole
colours: white, silver, black, grey
material: ABS

zaślepka LINEA-IN20 z otworem
kolory: biały, srebrny, czarny, szary
materiał: ABS

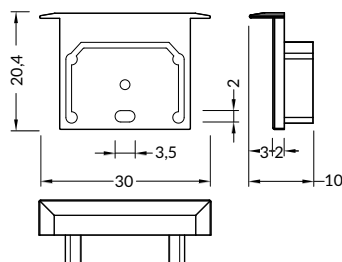

INDEX = 10 sets = 20 pcs
package > check the pricelist
INDEKS = 10 kpl = 20 szt.
opakowanie > patrz cennik

white / biały
E4990001

silver / srebrny
E4990040

black / czarny
E4990002

grey / szary
E4990022



ENDINGS / ZAŚLEPKI

LINEA-IN20-E7 ending with hole
colours: white, silver, black, grey
material: ABS

NEW

zaślepka LINEA-IN20-E7 z otworem
kolory: biały, srebrny, czarny, szary
materiał: ABS

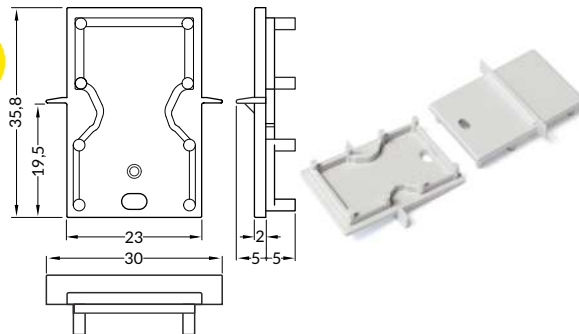

INDEX = 10 sets = 20 pcs
package > check the pricelist
INDEKS = 10 kpl = 20 szt.
opakowanie > patrz cennik

white / biały
E4999901

silver / srebrny
E4999940

black / czarny
E4999902

grey / szary
E4999922

MOUNTINGS / MOCOWANIA

U7 mounting plate
colour: inox
material: stainless steel

uchwyt **U7**
kolor: inox
materiał: stal nierdzewna

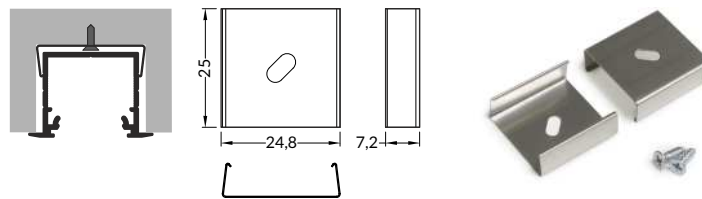

INDEX = 10 sets = 20 pcs
package > check the pricelist
INDEKS = 10 kpl = 20 szt.
opakowanie > patrz cennik

inox
E4960019

cone U7 mounting plate
colour: inox
material: stainless steel

uchwyt **U7** cone
kolor: inox
materiał: stal nierdzewna

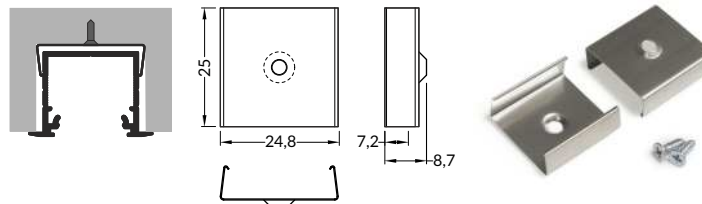

inox
E4970019

rack U7 mounting plate
colour: inox
material: stainless steel

uchwyt **U7** rack
kolor: inox
materiał: stal nierdzewna

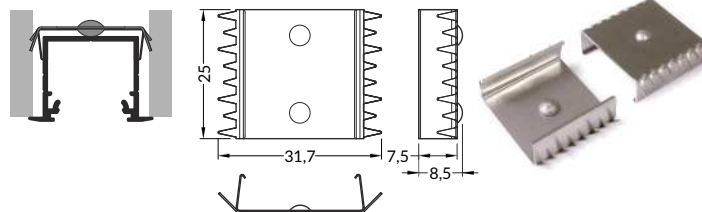

inox
E4980019

spring U7 mounting plate
colour: inox
material: stainless steel

uchwyt **U7** sprężyna
kolor: inox
materiał: stal nierdzewna

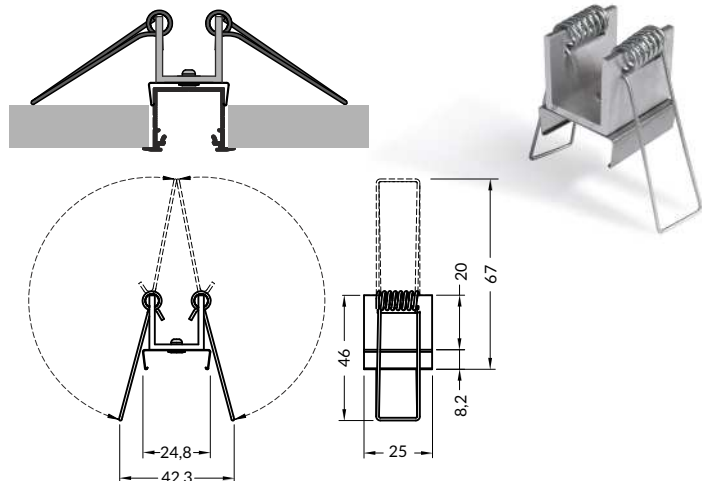

INDEX = 1 set = 2 pcs
package > check the pricelist
INDEKS = 1 kpl = 2 szt.
opakowanie > patrz cennik

inox
E4880019s

LINEA-IN20 EF/U7

CONNECTION POSSIBILITY MOŻLIWOŚCI ŁĄCZENIA



60°



90°



120°



135°



180°

ANGULAR CONNECTORS

Thanks to five different angle connectors (60° / 90° / 120° / 135° / 180°) it is possible to create many various lighting systems – with no need to cut the profile at an angle.

Bent connectors allows to connect profiles in two planes, at two angles: 90° on the inside and 270° on the outside.

ŁĄCZNIKI KĄTOWE

Dzięki łącznikom o pięciu różnych kątach (60° / 90° / 120° / 135° / 180°) możliwe jest tworzenie wielu różnych układów oświetlenia bez konieczności cięcia profilu pod skosem.

Łączniki gięte umożliwiają łączenie profili w dwóch płaszczyznach, pod dwoma kątami: wewnętrznym 90° i zewnętrznym 270°.

The component made of clear fabric provides secure connection, letting light through at the same time. Thanks to that, the luminaire can illuminate on the entire surface of the cover – even in the corners.

Element z przezroczystego tworzywa zapewnia stabilizację łączenia, jednocześnie przepuszczając światło. Dzięki temu oprawa może świecić na całej powierzchni klosza - również w rogach.



CONNECTORS / ŁĄCZNIKI

LINEA-IN20 connector 60 deg
colours: white, anodized, black
material: aluminium, polycarbonate

łącznik LINEA-IN20 60 st
kolory: biały, anodowany, czarny
materiał: aluminium, poliwęglan

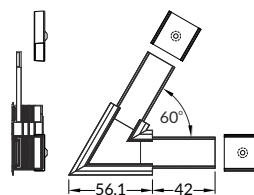

INDEX = 1 set
package > check the pricelist
INDEKS = 1 kpl
opakowanie > patrz cennik

white painted / biały malowany
E4890001s

anodized / anodowany
E4890002s

black anodized / czarny anodowany
E48900021s

LINEA-IN20 connector 90 deg
colours: white, anodized, black
material: aluminium, polycarbonate

łącznik LINEA-IN20 90 st
kolory: biały, anodowany, czarny
materiał: aluminium, poliwęglan

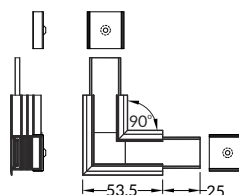

white painted / biały malowany
E4900001s

anodized / anodowany
E4900002s

black anodized / czarny anodowany
E49000021s

LINEA-IN20 connector 90 deg bent
colours: white, anodized, black
material: aluminium, polycarbonate

łącznik LINEA-IN20 90 st gięty
kolory: biały, anodowany, czarny
materiał: aluminium, poliwęglan

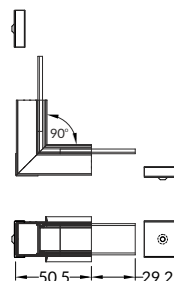

white painted / biały malowany
E4910001s

anodized / anodowany
E4910002s

black anodized / czarny anodowany
E49100021s

LINEA-IN20 connector 120 deg
colours: white, anodized, black
material: aluminium, polycarbonate

łącznik LINEA-IN20 120 st
kolory: biały, anodowany, czarny
materiał: aluminium, poliwęglan

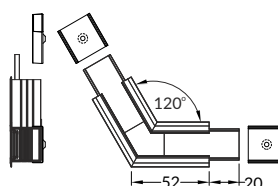

white painted / biały malowany
E4920001s

anodized / anodowany
E4920002s

black anodized / czarny anodowany
E49200021s

LINEA-IN20 connector 135 deg
colours: white, anodized, black
material: aluminium, polycarbonate

łącznik LINEA-IN20 135 st
kolory: biały, anodowany, czarny
materiał: aluminium, poliwęglan

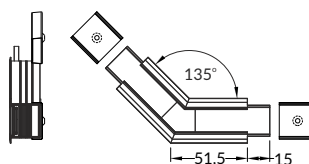

white painted / biały malowany
E4930001s

anodized / anodowany
E4930002s

black anodized / czarny anodowany
E49300021s

LINEA-IN20 connector 180 deg
material: polycarbonate

łącznik LINEA-IN20 180 st
materiał: poliwęglan

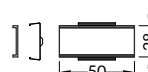

E4940000s

LINEA-IN20 connector 270 deg bent
colours: white, anodized, black
material: aluminium, polycarbonate

łącznik LINEA-IN20 270 st gięty
kolory: biały, anodowany, czarny
materiał: aluminium, poliwęglan

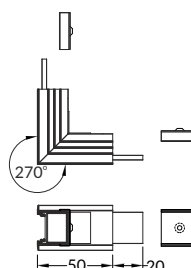

white painted / biały malowany
E4950001s

anodized / anodowany
E4950002s

black anodized / czarny anodowany
E49500021s



CLAMP / DOCISK

LINEA20 LED clamp

colour: white

material: painted steel, plastic

docisk LED LINEA20

kolor: biały

materiał: stal malowana, tworzywo

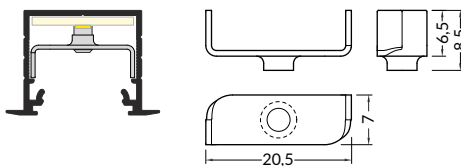

LINEA20-1 LED clamp

colour: white

material: painted steel, plastic

docisk LED LINEA20-1

kolor: biały

materiał: stal malowana, tworzywo

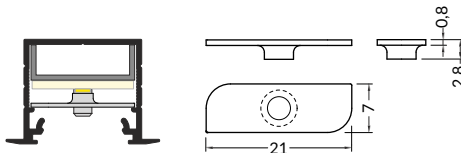

INDEX = 10 sets = 20 pcs
INDEKS = 10 kpl = 20 szt.

white / biały
C6940001

white / biały
C6930001

LED MOUNTING / MOCOWANIE LED

LINEA20 LED mounting

material: aluminium

mocowanie LED LINEA20

materiał: aluminium

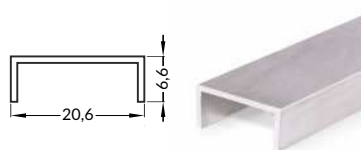

INDEX = 1 pc, length 2000 mm
package > check the pricelist
INDEKS = 1 szt., długość 2000 mm
opakowanie > patrz cennik

raw aluminium
surowe aluminium
C6060000

Available lengths: 1000 mm, 2000 mm, 3000 mm, 4000 mm.
The standard profile length tolerance is +20 mm. More details >> 1.08.

Dostępne długości: 1000 mm, 2000 mm, 3000 mm, 4000 mm.
Standardowa tolerancja długości profili wynosi: +20 mm. Więcej informacji >> 1.08.

LIGHTING EFFECT / EFEKT ŚWIECENIA

LINEA20 LED mounting + LINEA20-1 LED clamp / Mocowanie LED LINEA20 + docisk LED LINEA20-1



Lighting effect without LINEA20 LED mounting / Efekt świecenia bez użycia mocowania LED LINEA20



CONTINUOUS LIGHT OF LINE
when using LED strip 120 P/m and opal cover

CIĄGŁA LINIA ŚWIATŁA
przy użyciu taśm 120 P/m oraz klosza mlecznego



LINEA-IN20 TRIMLESS EF

REDUCED VISIBILITY OF PROFILE EDGE

POMNIEJSZONA WIDOCZNOŚĆ KRAWĘDZI PROFILU

- for spackle flange mounting
- Slick socket - easy assembly technology
- 3 mounting options of LED modules
- continuous line of light (when using LED strip 120 P/m and opal cover)
- maximum LED source width: 20 mm

- do zabudowy szpachlowej
- gniazdo Slick - prosty montaż klosza
- 3 sposoby mocowania modułów LED
- ciągła linia światła (przy użyciu taśmy 120 P/m oraz klosza mlecznego)
- maksymalna szerokość źródła LED: 20 mm



SIMILAR IN THE OFFER / PODOBNE W OFERCIE



LINEA20
EF/TY

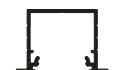

LINEA-IN20
EF/U7

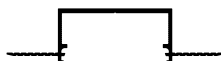

VARIO30-04



VARIO30-05

- E** slide cover
klosz E wsuwany
- F** click cover
klosz F klik
- E7** E7 click cover
klosz E7 klik

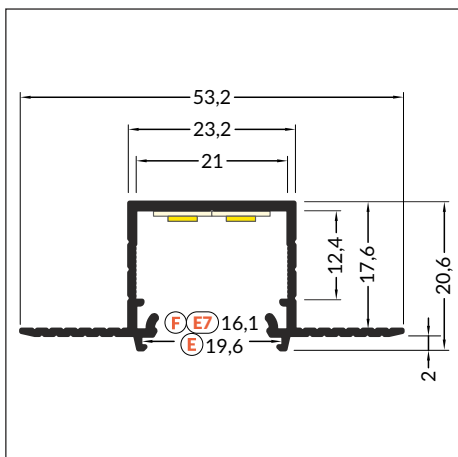
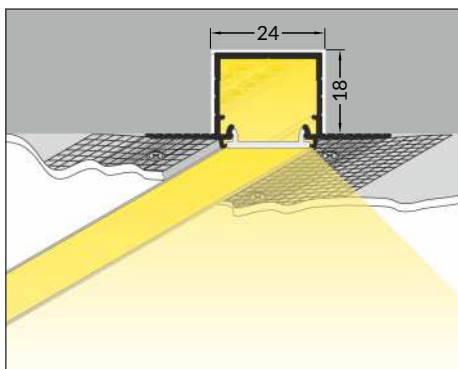
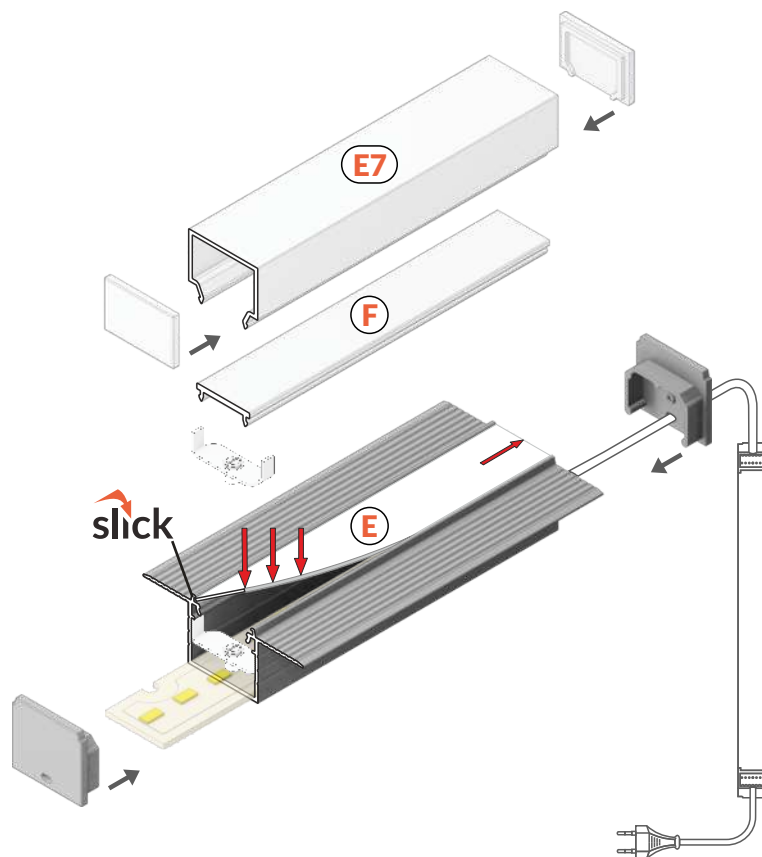

INDEX = 1 pc, length 2000 mm
package > check the pricelist
INDEKS = 1 szt., długość 2000 mm
opakowanie > patrz cennik

white painted
biały malowany
G1000201



anodized
anodowany
G1000220



raw aluminium
surowe aluminium
G1000200



max 20 mm



recessed
wpustowy

Available lengths: 1000 mm, 2000 mm, 3000 mm, 4000 mm.
The standard profile length tolerance is +20 mm.
More details >> 1.08.

Dostępne długości: 1000 mm, 2000 mm, 3000 mm, 4000 mm.
Standardowa tolerancja długości profili wynosi: +20 mm.
Więcej informacji >> 1.08.



COVERS / KLOSZE

E slide cover

colours: transparent, frosted, opal
material: PC, PP, PP

klosz E wsuwany
kolory: transparentny, szron, mleczny
materiał: PC, PP, PP



Note! Dimensions of the space to install LED source
Uwaga! Wymiary przestrzeni do zamontowania źródła LED

F click cover

colours: transparent, opal
material: PMMA

klosz F klik
kolory: transparentny, mleczny
materiał: PMMA

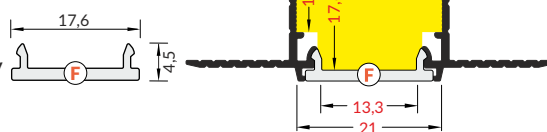

E7 click cover

colour: opal
material: PMMA

klosz E7 klik
kolor: mleczny
materiał: PMMA

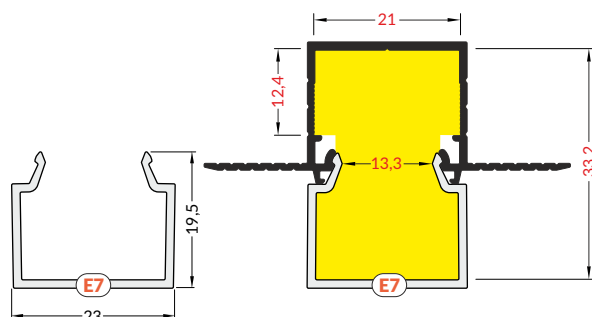

NEW

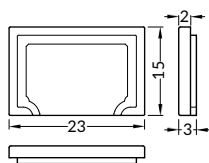

ENDINGS / ZAŚLEPKI

LINEA-IN20 TRIMLESS ending with hole
colours: white, silver, grey
material: ABS

zaślepka LINEA-IN20 TRIMLESS z otworem
kolory: biały, srebrny, szary
materiał: ABS

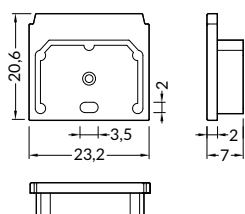

length 2000 mm
package > check the pricelist
długość 2000 mm
opakowanie > patrz cennik

E transparent / E transparentny
index = 10 pcs / indeks = 10 szt.

A2040016

E frosted / E szron
index = 10 pcs / indeks = 10 szt.

A2040039

E opal / E mleczny
index = 10 pcs / indeks = 10 szt.

A2040038

F transparent / F transparentny
index = 1 pc / indeks = 1 szt.

A2060016

F opal / F mleczny
index = 1 pc / indeks = 1 szt.

A2060038

reel, length 20 m
package > check the pricelist
rolka, długość 20 m
opakowanie > patrz cennik

F opal / F mleczny
index = 1 pc / indeks = 1 szt.

A2210038S

length 2000 mm
package > check the pricelist
długość 2000 mm
opakowanie > patrz cennik

E7 opal / E7 mleczny
index = 1 pc / indeks = 1 szt.

C1080038

The standard cover length tolerance is +20 mm.
More details >> 1.08.

Standardowa tolerancja długości kloszy wynosi: +20 mm
Więcej informacji >> 1.08.

INDEX = 1 set = 2 pcs
package > check the pricelist
INDEKS = 1 kpl = 2 szt.
opakowanie > patrz cennik

E7 opal ending
zaślepka E7 mleczny

C1840038

INDEX = 10 sets = 20 pcs
package > check the pricelist
INDEKS = 10 kpl = 20 szt.
opakowanie > patrz cennik

white / biały
G1000501

silver / srebrny
G1000540

grey / szary
G1000522



CLAMP / DOCISK

LINEA20 LED clamp

colour: white

material: painted steel, plastic

docisk LED LINEA20

kolor: biały

materiał: stal malowana, tworzywo

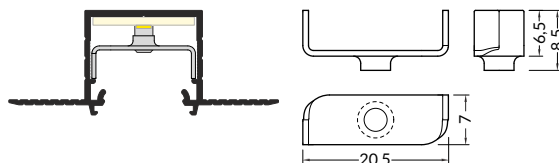

INDEX = 10 sets = 20 pcs
INDEKS = 10 kpl = 20 szt.

white / biały
C6940001

LINEA20-1 LED clamp

colour: white

material: painted steel, plastic

docisk LED LINEA20-1

kolor: biały

materiał: stal malowana, tworzywo

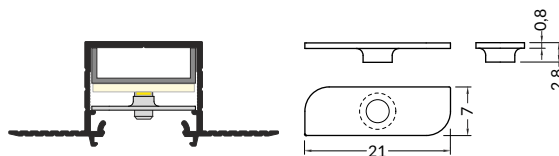

white / biały
C6930001

LED MOUNTING / MOCOWANIE LED

LINEA20 LED mounting

material: aluminium

mocowanie LED LINEA20

materiał: aluminium

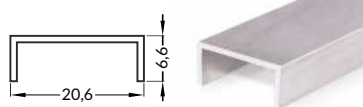

INDEX = 1 pc, length 2000 mm
package > check the pricelist
INDEKS = 1 szt., długość 2000 mm
opakowanie > patrz cennik

raw aluminium
surowe aluminium
C6060000

Available lengths: 1000 mm, 2000 mm, 3000 mm, 4000 mm.
The standard profile length tolerance is +20 mm. More details >> 1.08.

Dostępne długości: 1000 mm, 2000 mm, 3000 mm, 4000 mm.
Standardowa tolerancja długości profili wynosi: +20 mm. Więcej informacji >> 1.08.



How to select accessories, to achieve proper lighting effect?
>> 03.49

Jak dobrać akcesoria, aby uzyskać odpowiedni efekt świecenia?
>> 03.49



2020 LED PROFILES

PROFILE LED

CORNER / KĄTOWE



TRIO10 BC

ANGULAR PROFILE 45°

PROFIL KĄTOWY 45°

- for display cases' corners (mounted with screws)
 - recessed (mounted with adhesive glue)
 - suitable also for lighting up steps
 - maximum LED strip width: 10 mm
-
- do narożników gablot (montaż na wkręty)
 - do wpuszczania (mocowanie na klej montażowy)
 - nadaje się również do podświetlania stopni schodowych
 - maksymalna szerokość taśmy LED: 10 mm

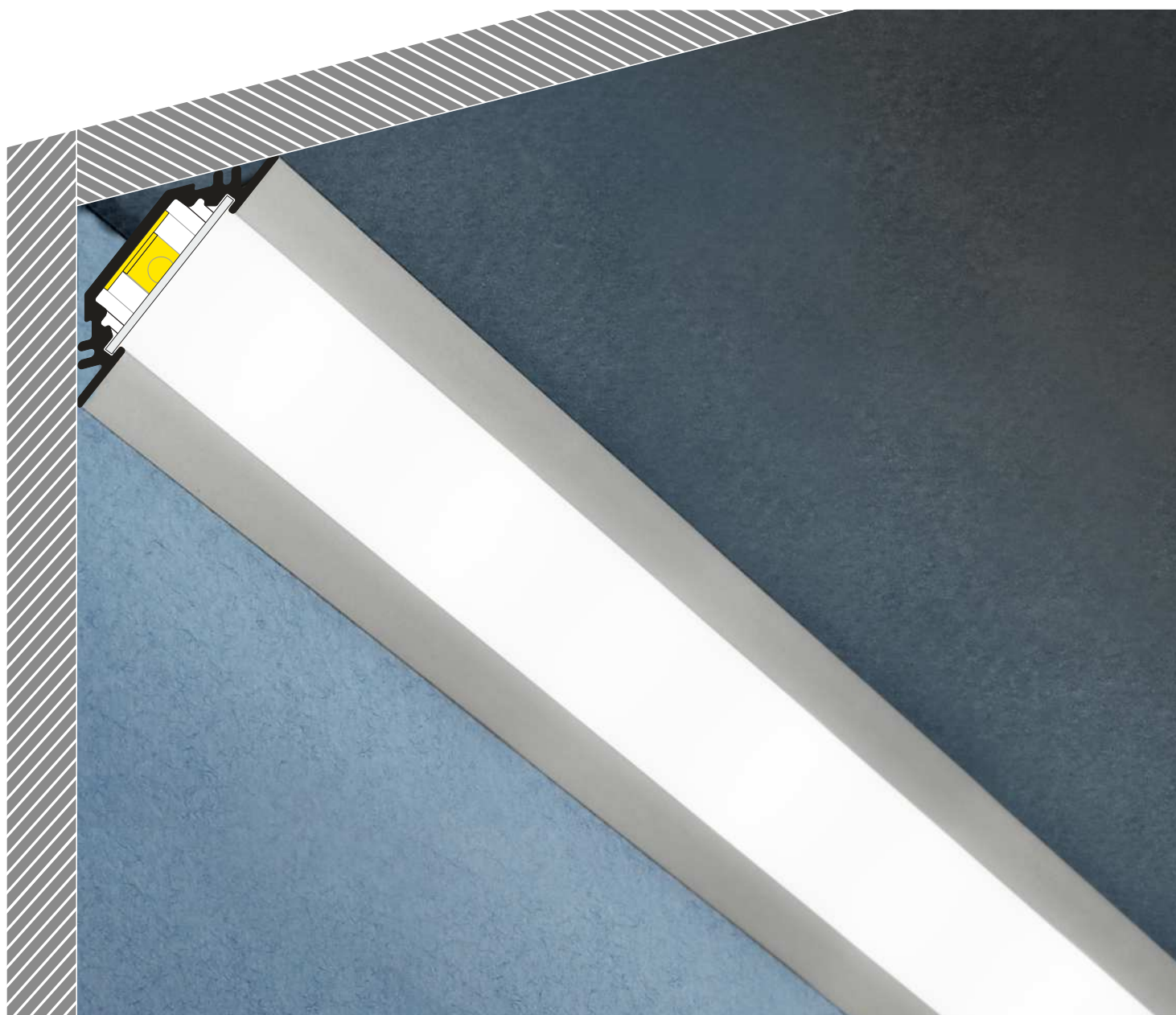

SIMILAR IN THE OFFER / PODOBNE W OFERCIE

CORNER10
BC/UX



QUARTER10
BD/U6

CABI12
E

CORNER14
EF/TY

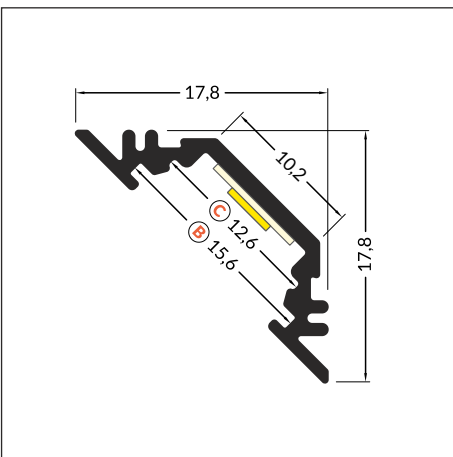
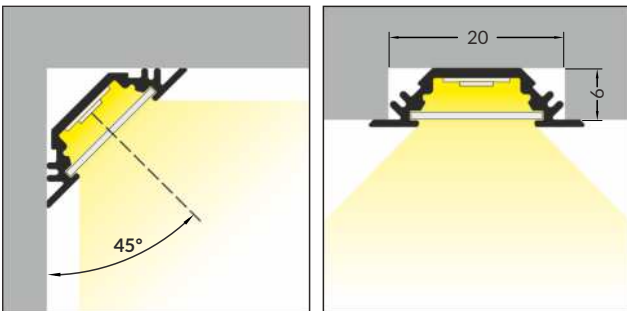
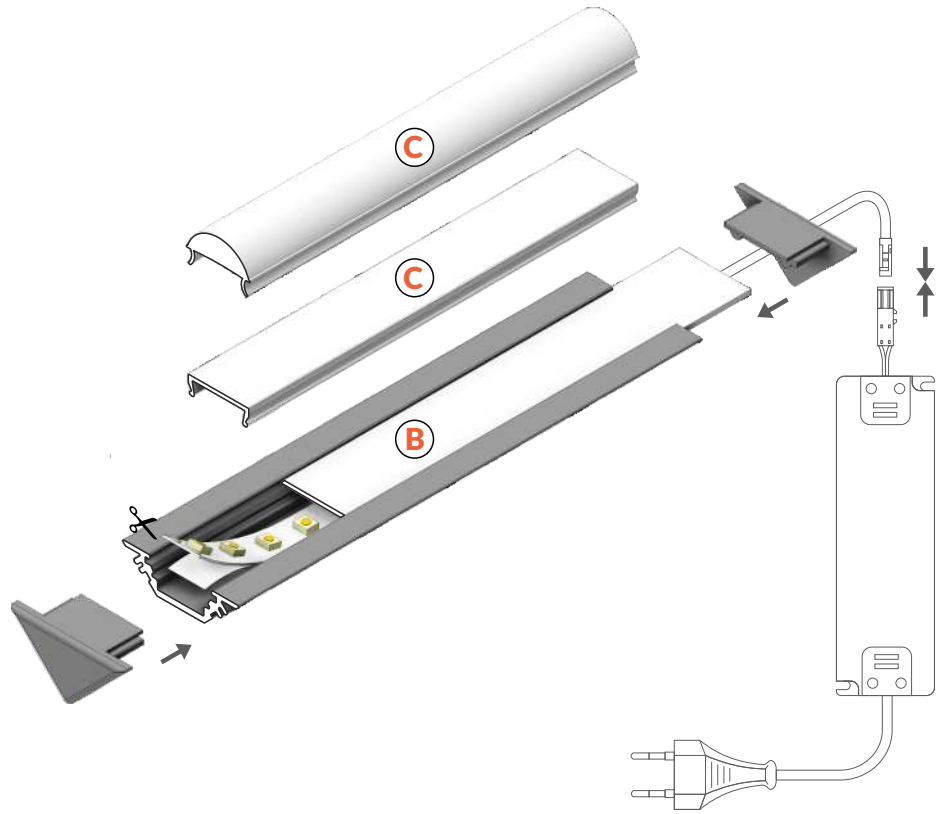

- B** slide cover
klosz B wsuwany
- C** click cover
klosz C klik
- C** lens cover
klosz C soczewka



INDEX = 1 pc, length 2000 mm
package > check the pricelist
INDEKS = 1 szt., długość 2000 mm
opakowanie > patrz cennik

white painted
biały malowany
91030001



anodized
anodowany
91030020



black anodized
czarny anodowany
91030021



raw aluminium
surowe aluminium
91030000

 max 10 mm

 corner
kątowy

Available lengths: 1000 mm, 2000 mm, 3000 mm, 4000 mm.
The standard profile length tolerance is +20 mm.
More details >> 1.08.

Dostępne długości: 1000 mm, 2000 mm, 3000 mm, 4000 mm.
Standardowa tolerancja długości profili wynosi: +20 mm.
Więcej informacji >> 1.08.



COVERS / KLOSZE

B slide cover

colours: transparent, frosted, opal
material: PC, PP, PP

klosz B wsuwany
kolory: transparentny, szron, mleczny
materiał: PC, PP, PP



Note! Dimensions of the space to install LED source
Uwaga! Wymiary przestrzeni do zamontowania źródła LED

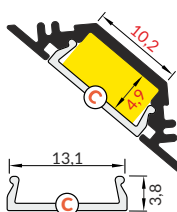
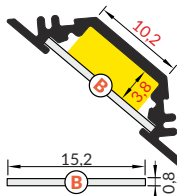

C click cover

colours: transparent, opal
material: PMMA

klosz C klik
kolory: transparentny, mleczny
materiał: PMMA

C lens click cover

colour: transparent
material: PC

klosz C klik soczewka
kolor: transparentny
materiał: PC

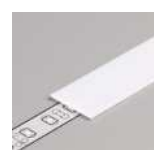
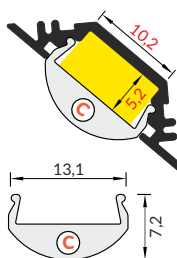

length 2000 mm
package > check the pricelist
długość 2000 mm
opakowanie > patrz cennik

B transparent / B transparentny
index = 10 pcs / indeks = 10 szt.
76250016

B frosted / B szron
index = 10 pcs / indeks = 10 szt.
76250039

B opal / B mleczny
index = 10 pcs / indeks = 10 szt.
76250038

C transparent / C transparentny
index = 1 pc / indeks = 1 szt.
76330000

C opal / C mleczny
index = 1 pc / indeks = 1 szt.
76330038

NEW

reel, length 20 m
package > check the pricelist
rolka, długość 20 m
opakowanie > patrz cennik

C opal / C mleczny
index = 1 pc / indeks = 1 szt.
76360038S

length 2000 mm
package > check the pricelist
długość 2000 mm
opakowanie > patrz cennik

C lens / C soczewka
index = 1 pc / indeks = 1 szt.
76300000

The standard cover length tolerance is +20 mm.
More details >> 1.08.

Standardowa tolerancja długości kloszy wynosi: +20 mm
Więcej informacji >> 1.08.

ENDINGS / ZAŚLEPKI

TRIO10 ending

colours: white, silver, black, grey
material: ABS

zaślepka TRIO10
kolory: biały, srebrny, czarny, szary
materiał: ABS

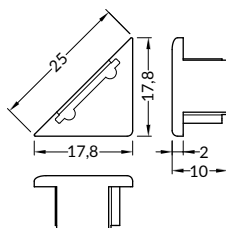

Ending with marked space to bore the holes.
Zaślepka z punktami do przewiercenia otworów.

INDEX = 10 sets = 20 pcs
package > check the pricelist
INDEKS = 10 kpl = 20 szt.
opakowanie > patrz cennik

white / biały
91060001

silver / srebrny
91060040

black / czarny
91060002

grey / szary
91060022

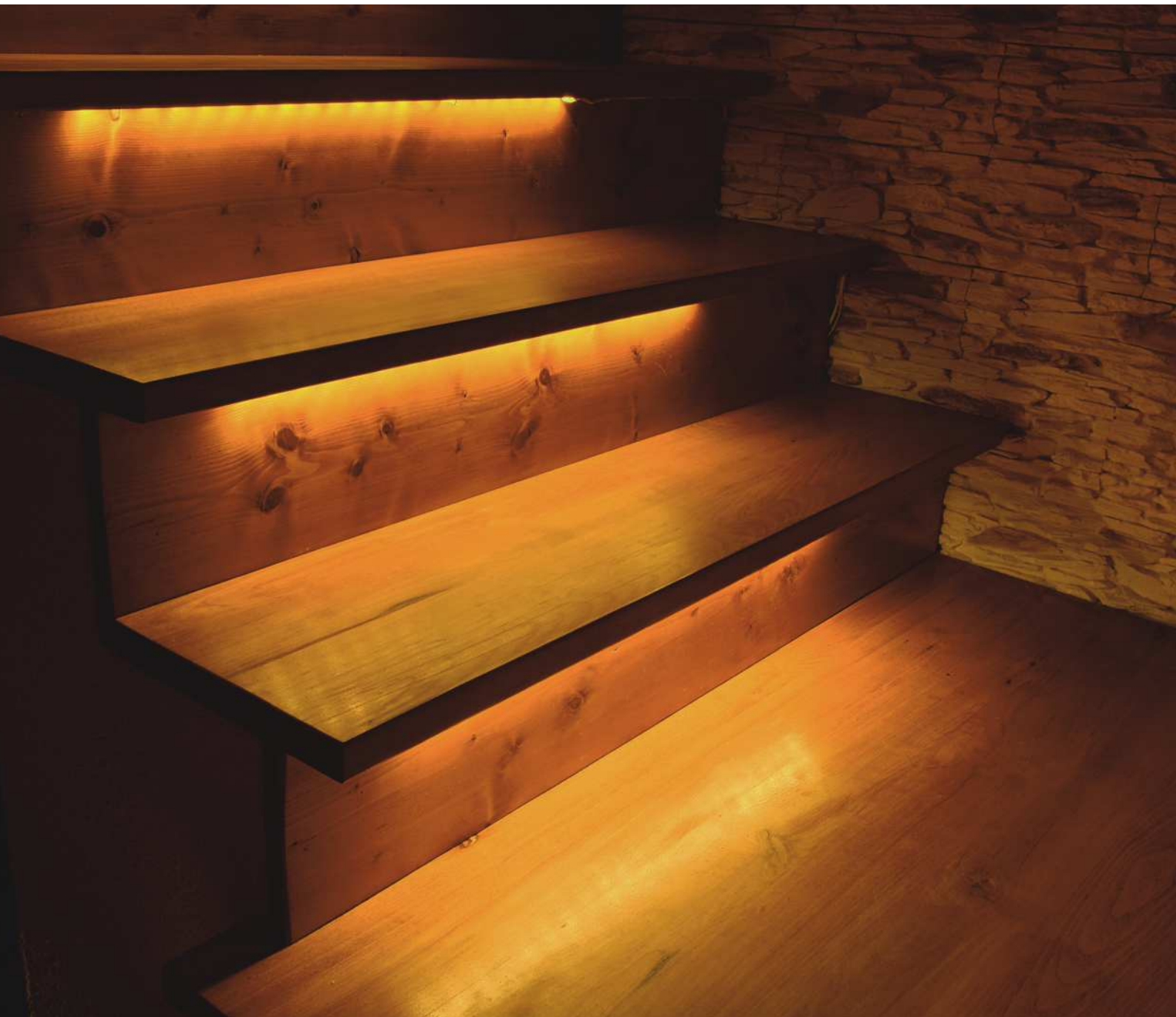

CORNER10 BC/UX

SMALL, ALUMINIUM, ANGULAR PROFILE

MAŁY, ALUMINIOWY PROFIL KĄTOWY

- lighting directions: 30° or 60°
- hidden mounting
- wide range of accessories, 6 types of covers
- maximum LED strip width: 10 mm

- dwa kąty świecenia: 30° i 60°
- ukryte mocowanie
- szeroki wybór akcesoriów, 6 rodzajów kloszy
- maksymalna szerokość taśmy LED: 10 mm



SIMILAR IN THE OFFER / PODOBNE W OFERCIE



TRIO10
BC



QUARTER10
BD/U6



CABI12
E



CORNER14
EF/TY



CORNER27
G/UX



B slide cover
klosz B wsuwany

C click cover
klosz C klik

C lens cover
klosz C soczewka

U¹ U flexible mounting plate
uchwyt U sprężysty

U² cone U flexible mounting plate
uchwyt U sprężysty cone

X¹ X mounting plate
uchwyt X

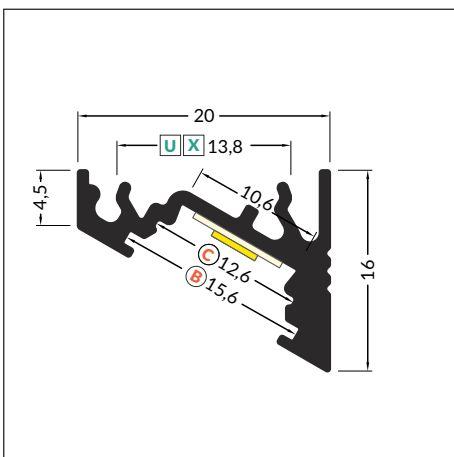
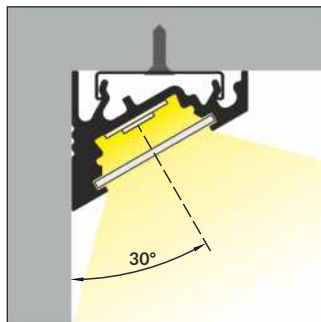
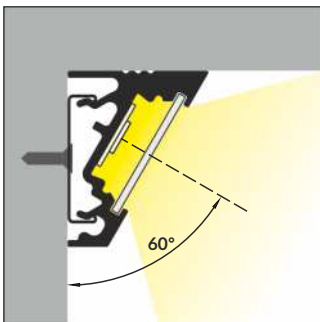
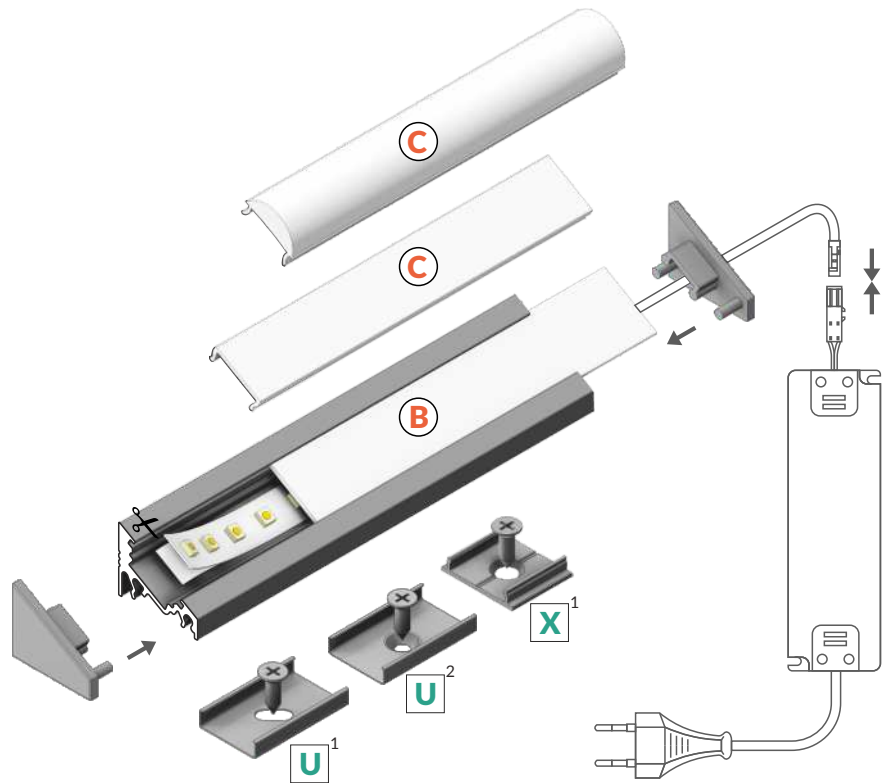

max 10 mm



corner
kątowy



INDEX = 1 pc, length 2000 mm
package > check the pricelist
INDEKS = 1 szt., długość 2000 mm
opakowanie > patrz cennik

white painted
biały malowany
83050001

anodized
anodowany
83050020

black anodized
czarny anodowany
83050021

raw aluminium
surowe aluminium
83050000

Available lengths: 1000 mm, 2000 mm, 3000 mm, 4000 mm.
The standard profile length tolerance is +20 mm.
More details >> 1.08.

Dostępne długości: 1000 mm, 2000 mm, 3000 mm, 4000 mm.
Standardowa tolerancja długości profili wynosi: +20 mm.
Więcej informacji >> 1.08.



COVERS / KLOSZE

B slide cover

colours: transparent, frosted, opal
material: PC, PP, PP

klosz B wsuwany
kolory: transparentny, szron, mleczny
materiał: PC, PP, PP

C click cover

colours: transparent, opal
material: PMMA

klosz C klik
kolory: transparentny, mleczny
materiał: PMMA

C click cover lens

colour: transparent
material: PC

klosz C klik soczewka
kolor: transparentny
materiał: PC



Note! Dimensions of the space to install LED source
Uwaga! Wymiary przestrzeni do zamontowania źródła LED

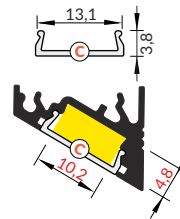
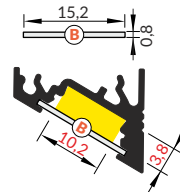

NEW

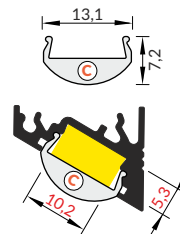

length 2000 mm
package > check the pricelist
długość 2000 mm
opakowanie > patrz cennik

B transparent / B transparentny
index = 10 pcs / indeks = 10 szt.
76250016

B frosted / B szron
index = 10 pcs / indeks = 10 szt.
76250039

B opal / B mleczny
index = 10 pcs / indeks = 10 szt.
76250038

C transparent / C transparentny
index = 1 pc / indeks = 1 szt.
76330000

C opal / C mleczny
index = 1 pc / indeks = 1 szt.
76330038



reel, length 20 m
package > check the pricelist
rolka, długość 20 m
opakowanie > patrz cennik

C opal / C mleczny
index = 1 pc / indeks = 1 szt.
76360038S



length 2000 mm
package > check the pricelist
długość 2000 mm
opakowanie > patrz cennik

C lens / C soczewka
index = 1 pc / indeks = 1 szt.
76300000

The standard cover length tolerance is +20 mm.
More details >> 1.08.

Standardowa tolerancja długości kloszy wynosi: +20 mm
Więcej informacji >> 1.08.

ENDINGS / ZAŚLEPKI

CORNER10 ending gen2

colours: white, silver, black, grey
material: ABS

zaślepka CORNER10 gen2
kolory: biały, srebrny, czarny, szary
materiał: ABS

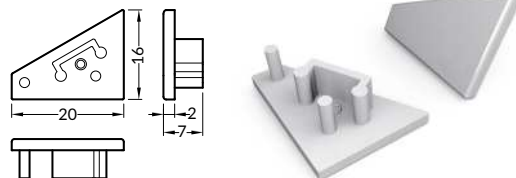

CORNER10 ending gen2 with hole

colours: white, silver, black, grey
material: ABS

zaślepka CORNER10 gen z otworem
kolory: biały, srebrny, czarny, szary
materiał: ABS

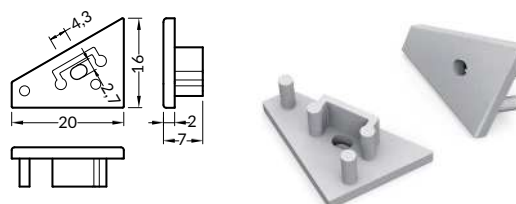

INDEX = 10 sets = 20 pcs
package > check the pricelist
INDEKS = 10 kpl = 20 szt.
opakowanie > patrz cennik

white / biały
83990001

silver / srebrny
83990040

black / czarny
83990002

grey / szary
83990022

white / biały
83980001

silver / srebrny
83980040

black / czarny
83980002

grey / szary
83980022



CONNECTORS / ŁĄCZNIKI

X connector 180 deg
colour: raw aluminium
material: aluminium

łączenie X 180 st
kolor: surowe aluminium
materiał: aluminium

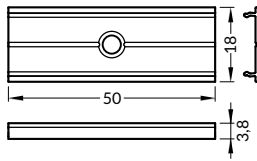

INDEX = 1 set
package > check the pricelist
INDEKS = 1 kpl
opakowanie > patrz cennik

raw aluminium
surowe aluminium
76350000

CORNER10 connector 90 deg
colours: white, anodized, black
material: aluminium

łączenie CORNER10 90 st
kolory: biały, anodowany, czarny
materiał: aluminium

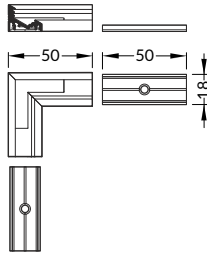

INDEX = 1 set
package > check the pricelist
INDEKS = 1 kpl
opakowanie > patrz cennik

white painted
biały malowany
83110001
anodized
anodowany
83110020
black anodized
czarny anodowany
83110021

MOUNTINGS / MOCOWANIA

U flexible mounting plate
colours: inox
material: stainless steel

uchwyt U sprężysty
kolory: inox
materiał: stal nierdzewna

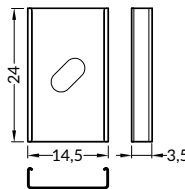
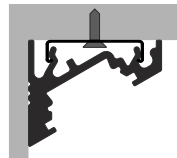

INDEX = 10 sets = 20 pcs
package > check the pricelist
INDEKS = 10 kpl = 20 szt.
opakowanie > patrz cennik

inox
76380000

cone U flexible mounting plate
colours: inox
material: stainless steel

uchwyt U sprężysty cone
kolory: inox
materiał: stal nierdzewna

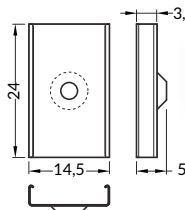
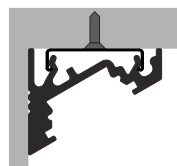

inox
76620000

X mounting plate
colours: raw aluminium
material: aluminium

uchwyt X
kolory: surowe aluminium
materiał: aluminium

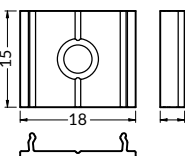
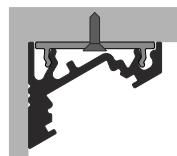

raw aluminium
surowe aluminium
76260000



QUARTER10 BD/U6

LIGHT FROM AN ANGLE

ŚWIATŁO Z NAROŻNIKA

- full circle quadrant illumination
- LED strip aligned to 45° angle
- Slick socket
- maximum LED strip width: 10 mm
- pełne oświetlenie ćwiartki koła
- taśma ustawiona pod kątem 45 stopni
- gniazdo Slick
- maksymalna szerokość taśmy LED: 10 mm

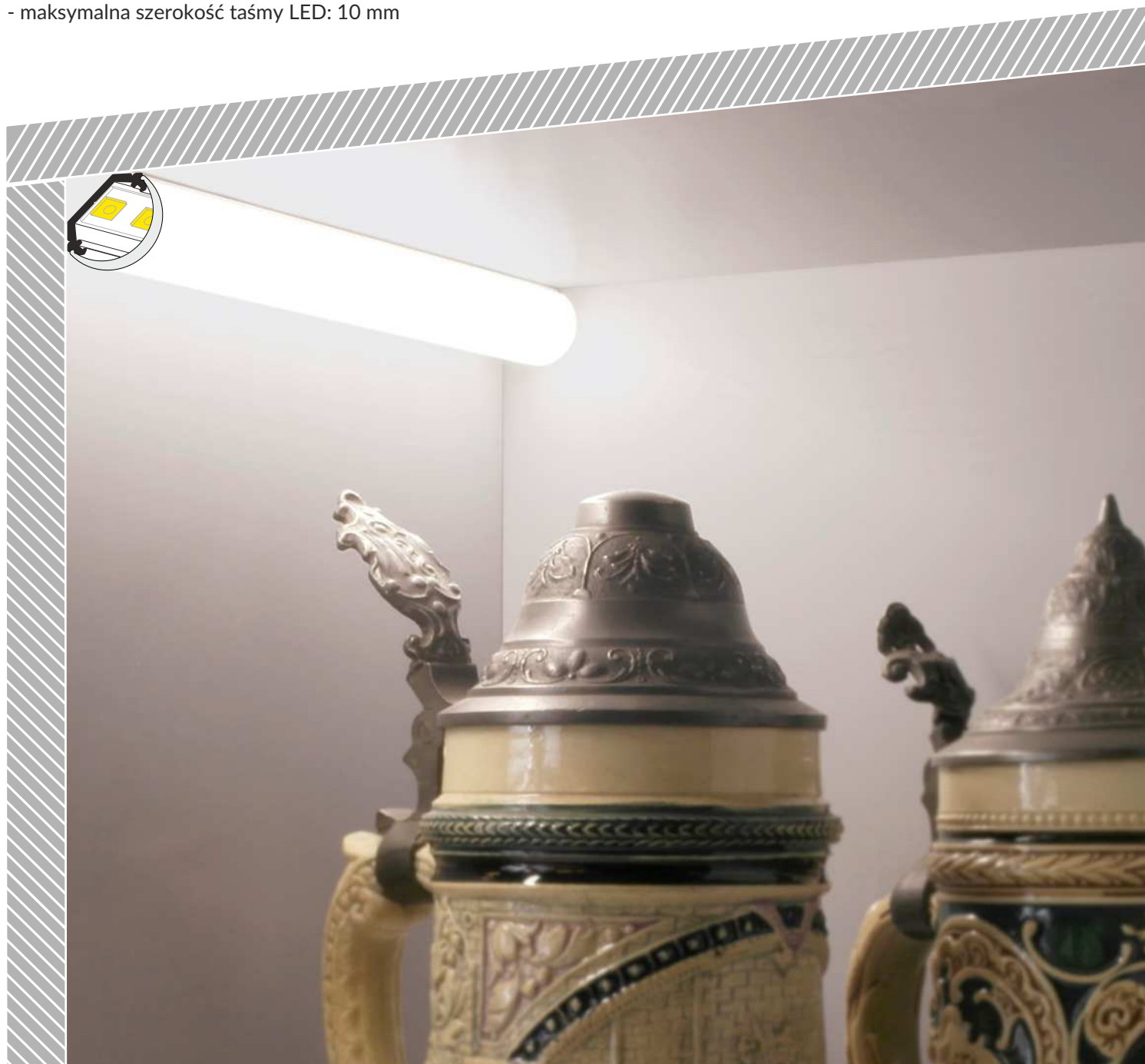

SIMILAR IN THE OFFER / PODOBNE W OFERCIE



TRIO10
BC



CORNER10
BC/UX



CABI12
E



CORNER14
EF/TY



CORNER27
G/UX



B slide cover
klosz B wsuwany

D click cover
klosz D klik

U6¹ U6 mounting plate
uchwyt U6

U6² cone U6 mounting plate
uchwyt U6 cone

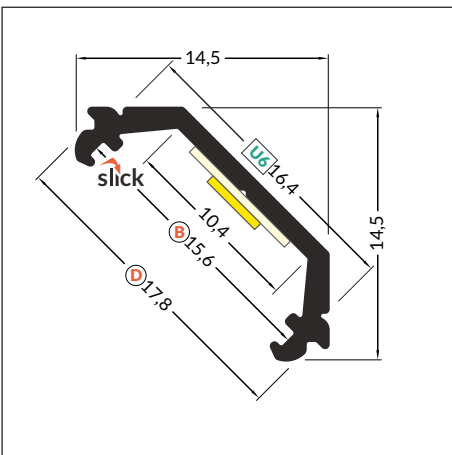
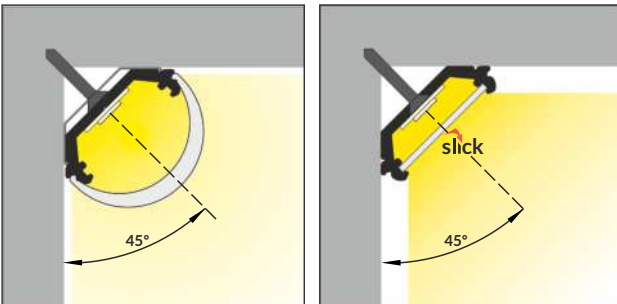
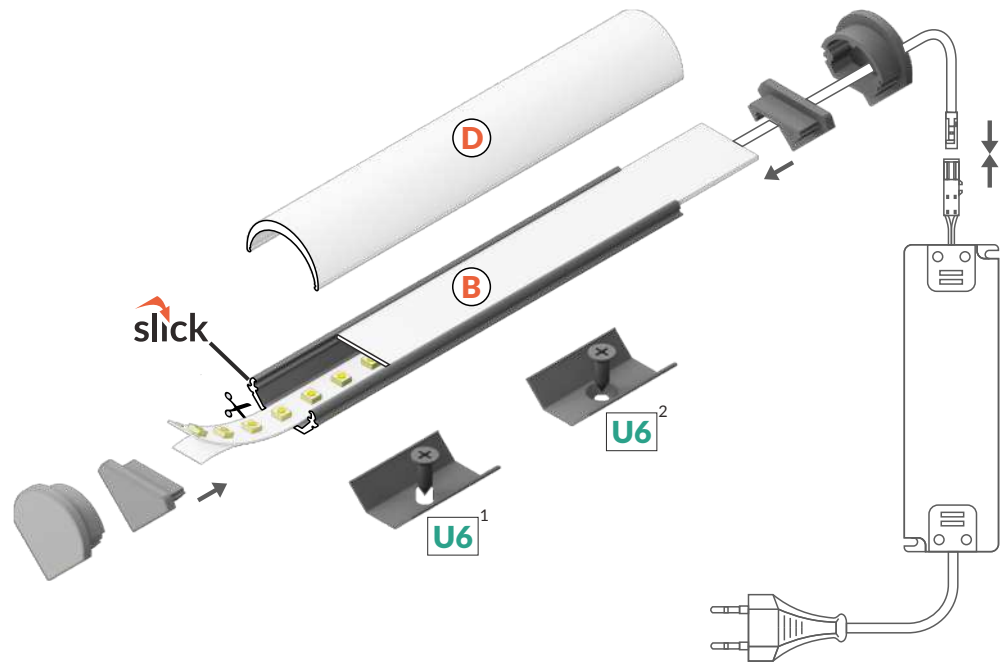

 max 10 mm

 corner
kątowy

INDEX = 1 pc, length 2000 mm
package > check the pricelist
INDEKS = 1 szt., długość 2000 mm
opakowanie > patrz cennik

anodized
anodowany
D3020020

Available lengths: 1000 mm, 2000 mm, 3000 mm, 4000 mm.
The standard profile length tolerance is +20 mm.
More details >> 1.08.

Dostępne długości: 1000 mm, 2000 mm, 3000 mm, 4000 mm.
Standardowa tolerancja długości profili wynosi: +20 mm.
Więcej informacji >> 1.08.



COVERS / KLOSZE

B slide cover

colours: transparent, frosted, opal
material: PC, PP, PP

klosz B wsuwany
kolory: transparentny, szron, mleczny
materiał: PC, PP, PP

D click cover

colour: opal
material: PMMA

klosz D klik
kolor: mleczny
materiał: PMMA



Note! Dimensions of the space to install LED source
Uwaga! Wymiary przestrzeni do zamontowania źródła LED

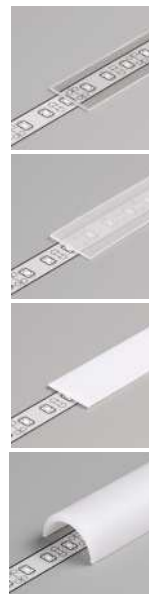
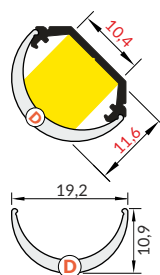
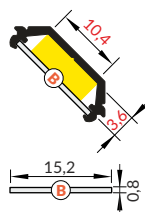

length 2000 mm
package > check the pricelist
długość 2000 mm
opakowanie > patrz cennik

B transparent / B transparentny
index = 10 pcs / indeks = 10 szt.

76250016

B frosted / B szron
index = 10 pcs / indeks = 10 szt.

76250039

B opal / B mleczny
index = 10 pcs / indeks = 10 szt.

76250038

D opal / D mleczny
index = 1 pc / indeks = 1 szt.

A1140038

The standard cover length tolerance is +20 mm.
More details >> 1.08.

Standardowa tolerancja długości kloszy wynosi: +20 mm
Więcej informacji >> 1.08.

ENDINGS / ZAŚLEPKI

QUARTER10 ending

colours: silver, grey
material: ABS
zaślepka QUARTER10
kolory: srebrny, szary
materiał: ABS



Ending with marked space to bore the holes.
Zaślepka z punktami do przewiercenia otworów.

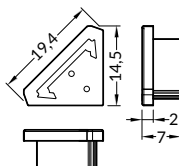

QUARTER10 D ending

colours: silver, grey
material: ABS
zaślepka QUARTER10 D
kolory: srebrny, szary
materiał: ABS

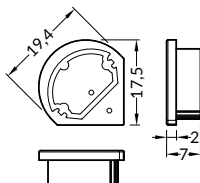

INDEX = 10 sets = 20 pcs
package > check the pricelist
INDEKS = 10 kpl = 20 szt.
opakowanie > patrz cennik

silver / srebrny
D3980040

grey / szary
D3980022

silver / srebrny
D3990040

grey / szary
D3990022

MOUNTINGS / MOCOWANIA

U6 mounting plate

colours: inox
material: stainless steel

uchwyt U6
kolory: inox
materiał: stal nierdzewna

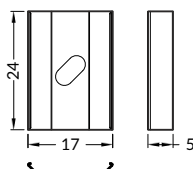
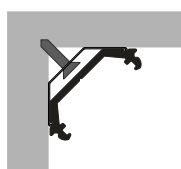

cone U6 mounting plate

colours: inox
material: stainless steel

uchwyt U6 cone
kolory: inox
materiał: stal nierdzewna

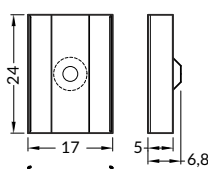
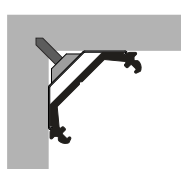

INDEX = 10 sets = 20 pcs
package > check the pricelist
INDEKS = 10 kpl = 20 szt.
opakowanie > patrz cennik

inox
D3960019

inox
D3970019



A PROFILE FOR SHOW CASE'S INSIDE VERTICAL AND HORIZONTAL ILLUMINATION PROFIL DO OŚWIETLENIA WNĘTRZA GABLOTY W PIONIE I POZIOMIE

- two lighting angles: 30°/60°
- small sizes, no holders and a channel for hiding cables
 - minimum interference in glass show case's look
- Slick socket
- maximum LED strip width: 12 mm

- dwa kąty świecenia: 30°/60°
- niewielkie gabaryty, brak uchwytów oraz kanał do schowania przewodów
 - minimalna ingerencja w wygląd szklanej gabloty
- gniazdo z funkcją Slick
- taśmy LED: 12 mm

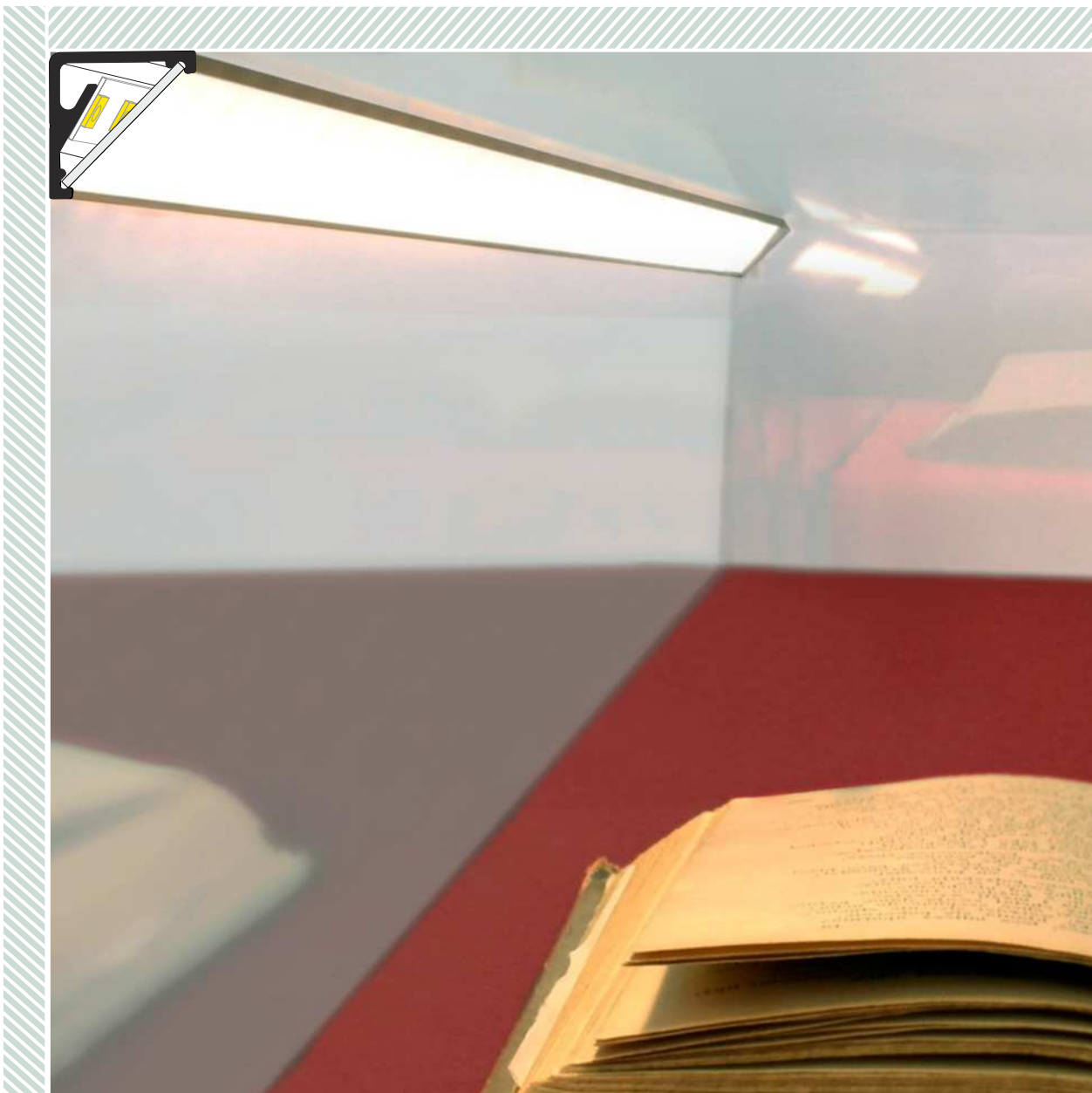



SIMILAR IN THE OFFER / PODOBNE W OFERCIE



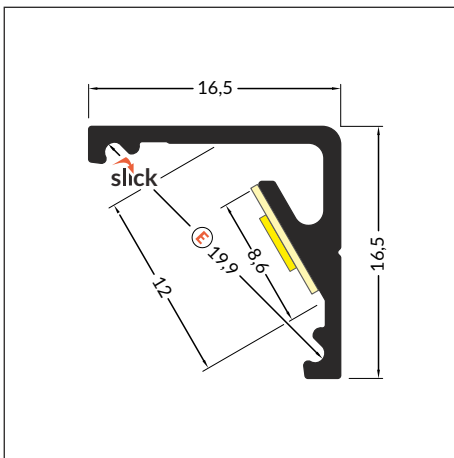
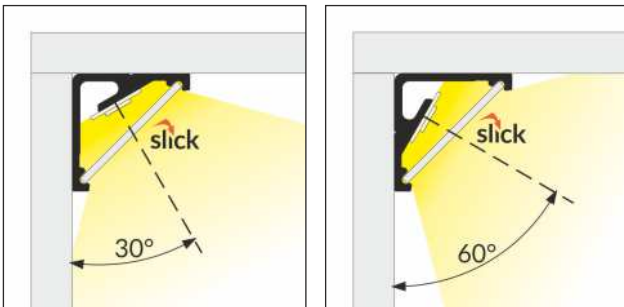
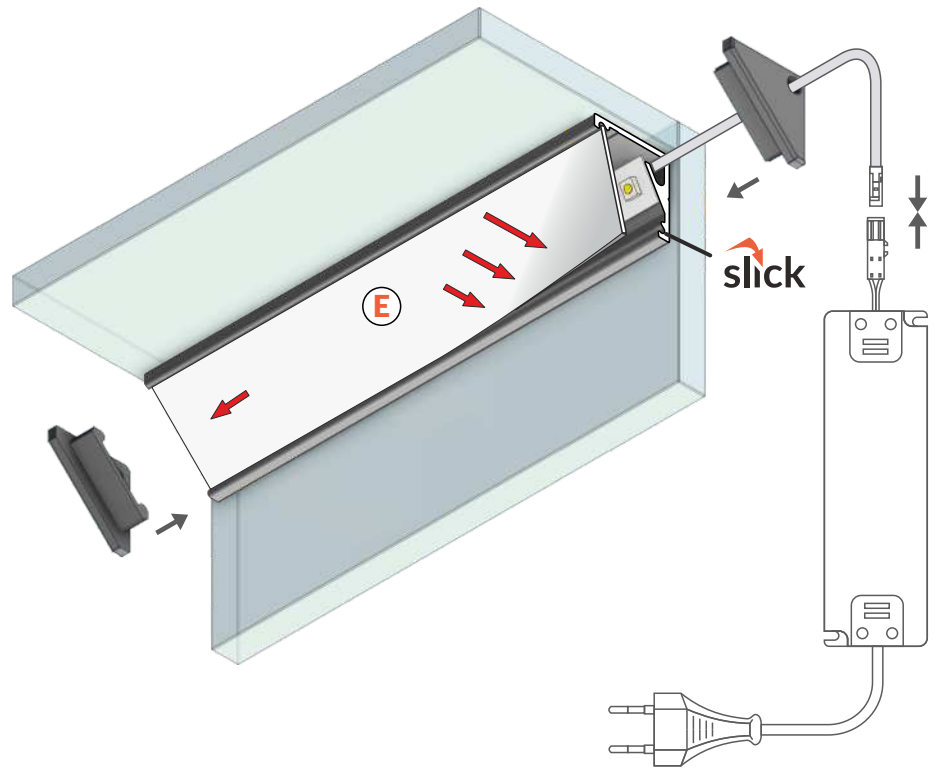

E slide cover
klosz E wsuwany



 max 12 mm

 corner
kątowy



INDEX = 1 pc, length 2000 mm
package > check the pricelist
INDEKS = 1 szt., długość 2000 mm
opakowanie > patrz cennik

white painted
biały malowany
C9020001



anodized
anodowany
C9020020



black anodized
czarny anodowany
C9020021



raw aluminium
surowe aluminium
C9020000

Available lengths: 1000 mm, 2000 mm.
The standard profile length tolerance is +20 mm.
More details >> 1.08.

Dostępne długości: 1000 mm, 2000 mm.
Standardowa tolerancja długości profili wynosi: +20 mm.
Więcej informacji >> 1.08.



COVERS / KLOSZE

E slide cover
colours: transparent, frosted, opal
material: PC, PP, PP

klosz **E** wsuwany
kolory: transparentny, szron, mleczny
materiał: PC, PP, PP



Note! Dimensions of the space to install LED source
Uwaga! Wymiary przestrzeni do zamontowania źródła LED

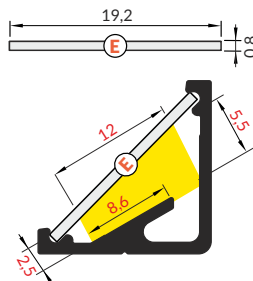

length 2000 mm
package > check the pricelist
długość 2000 mm
opakowanie > patrz cennik

E transparent / E transparentny
index = 10 pcs / indeks = 10 szt.

A2040016

E frosted / E szron
index = 10 pcs / indeks = 10 szt.

A2040039

E opal / E mleczny
index = 10 pcs / indeks = 10 szt.

A2040038

The standard cover length tolerance is +20 mm.
More details >> 1.08.

Standardowa tolerancja długości kloszy wynosi: +20 mm
Więcej informacji >> 1.08.

ENDINGS / ZAŚLEPKI

CABI12 ending
colours: white, silver, black, grey
material: ABS

zaślepka CABI12
kolory: biały, srebrny, czarny, szary
materiał: ABS

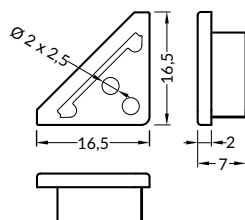

Ending with marked space to bore the holes.
Zaślepka z punktami do przewiercenia otworów.

INDEX = 10 sets = 20 pcs
package > check the pricelist
INDEKS = 10 kpl = 20 szt.
opakowanie > patrz cennik

white / biały
C9980001

silver / srebrny
C9980040

black / czarny
C9980002

grey / szary
C9980022



INVISIBLE WIRES

Special channel to hide the wires allows to remain esthetic look of the showcase.

NIEWIDOCZNE PRZEWODY

Kanał do schowania przewodów pozwala zachować estetyczny wygląd gabloty.



EQUAL SIDE LENGTHS

The symmetrical profile design allows precise connections in a different configurations.

RÓWNE DŁUGOŚCI BOKÓW

Symetryczna budowa profilu umożliwia precyzyjne łączenie w różnych konfiguracjach.

CORNER14 EF/TY

ANGULAR PROFILE 30°/60°

PROFIL KĄTOWY 30°/60°

- hidden mounting
- two lighting angles: 30°/60°
- maximum LED strip width: 14 mm

- ukryte mocowanie
- dwa kąty świecenia: 30°/60°
- maksymalna szerokość taśmy LED: 14 mm



SIMILAR IN THE OFFER / PODOBNE W OFERCIE



TRIO10
BC



CORNER10
BC/UX



QUARTER10
BD/U6



CABI12
E



CORNER27
G/UX



E slide cover
klosz E wsuwany

F click cover
klosz F klik

E7 E7 click cover
klosz E7 klik

Y¹ Y flexible mounting plate
uchwyt Y sprężysty

Y² cone Y flexible mounting plate
uchwyt Y sprężysty cone

T mounting plate
uchwyt T

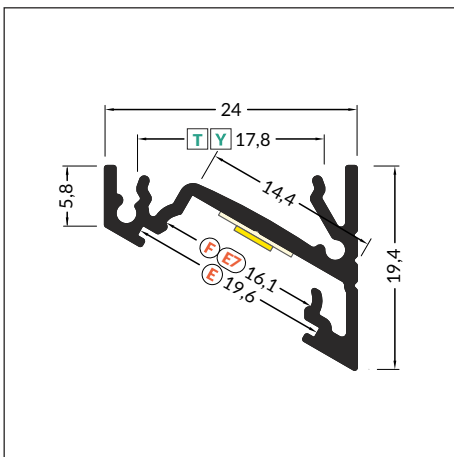
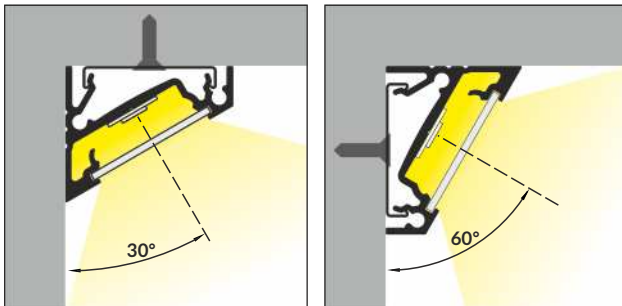
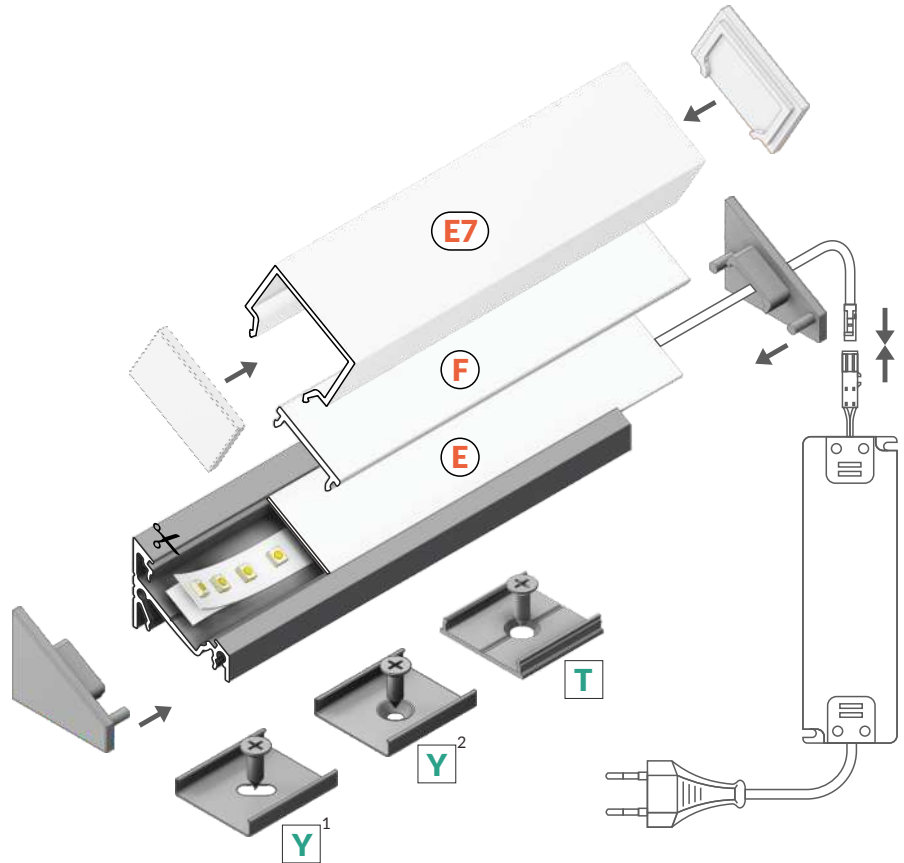

 max 14 mm

 corner
kątowy



INDEX = 1 pc, length 2000 mm
package > check the pricelist
INDEKS = 1 szt., długość 2000 mm
opakowanie > patrz cennik

white painted
biały malowany
A4020001

anodized
anodowany
A4020020

black anodized
czarny anodowany
A4020021

raw aluminium
surowe aluminium
A4020000

Available lengths: 1000 mm, 2000 mm, 3000 mm, 4000 mm.
The standard profile length tolerance is +20 mm.
More details >> 1.08.

Dostępne długości: 1000 mm, 2000 mm, 3000 mm, 4000 mm.
Standardowa tolerancja długości profili wynosi: +20 mm.
Więcej informacji >> 1.08.



COVERS / KLOSZE

E slide cover

colours: transparent, frosted, opal
material: PC, PP, PP

klosz E wsuwany
kolory: transparentny, szron, mleczny
materiał: PC, PP, PP



Note! Dimensions of the space to install LED source
Uwaga! Wymiary przestrzeni do zamontowania źródła LED

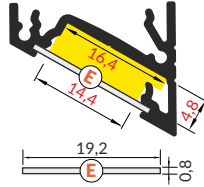

F click cover

colours: transparent, opal
material: PMMA

klosz F klik
kolory: transparentny, mleczny
materiał: PMMA

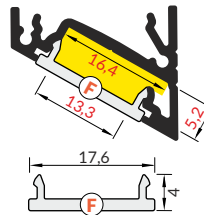

E7 click cover

colour: opal
material: PMMA

klosz E7 klik
kolor: mleczny
materiał: PMMA

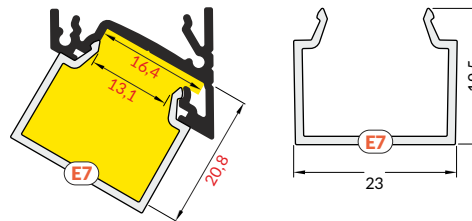

NEW

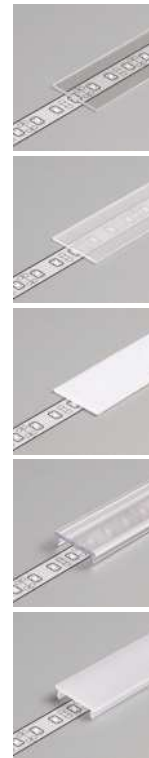

length 2000 mm
package > check the pricelist
długość 2000 mm
opakowanie > patrz cennik

E transparent / E transparentny
index = 10 pcs / indeks = 10 szt.

A2040016

E frosted / E szron
index = 10 pcs / indeks = 10 szt.

A2040039

E opal / E mleczny
index = 10 pcs / indeks = 10 szt.

A2040038

F transparent / F transparentny
index = 1 pc / indeks = 1 szt.

A2060016

F opal / F mleczny
index = 1 pc / indeks = 1 szt.

A2060038



reel, length 20 m
package > check the pricelist
rolka, długość 20 m
opakowanie > patrz cennik

F opal / F mleczny
index = 1 pc / indeks = 1 szt.

A2210038S



length 2000 mm
package > check the pricelist
długość 2000 mm
opakowanie > patrz cennik

E7 opal / E7 mleczny
index = 1 pc / indeks = 1 szt.

C1080038

The standard cover length tolerance is +20 mm.
More details >> 1.08.

Standardowa tolerancja długości kloszy wynosi: +20 mm
Więcej informacji >> 1.08.

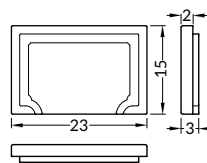

INDEX = 1 set = 2 pcs
package > check the pricelist
INDEKS = 1 kpl = 2 szt.
opakowanie > patrz cennik

E7 opal ending
zaślepka E7 mleczny

C1840038

MOUNTING / MOCOWANIA

Y flexible mounting plate

colour: inox
material: stainless steel

uchwyt Y sprężysty
kolor: inox
materiał: stal nierdzewna

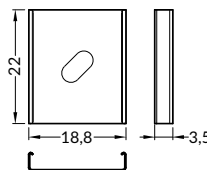
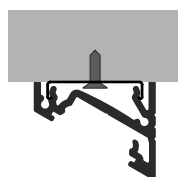

cone Y flexible mounting plate

colour: inox
material: stainless steel

uchwyt Y sprężysty cone
kolor: inox
materiał: stal nierdzewna

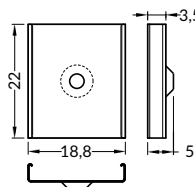
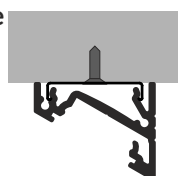

INDEX = 10 sets = 20 pcs
package > check the pricelist
INDEKS = 10 kpl = 20 szt.
opakowanie > patrz cennik

inox
A2090019

inox
A2130019



MOUNTING / MOCOWANIA

T mounting plate
colour: raw aluminium
material: aluminium

uchwyt **T**
kolor: surowe aluminium
materiał: aluminium

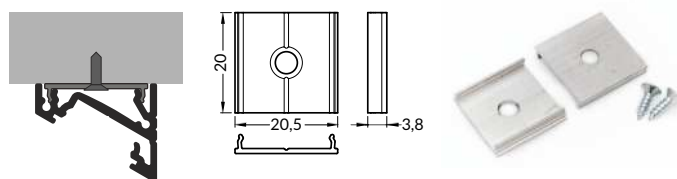

INDEX = 10 sets = 20 pcs
package > check the pricelist
INDEKS = 10 kpl = 20 szt.
opakowanie > patrz cennik

raw aluminium
surowe aluminium
C6960000

ENDINGS / ZAŚLEPKI

CORNER14 ending gen2
colours: white, silver, black, grey
material: ABS

zaślepka CORNER14 gen2
kolory: biały, srebrny, czarny, szary
materiał: ABS

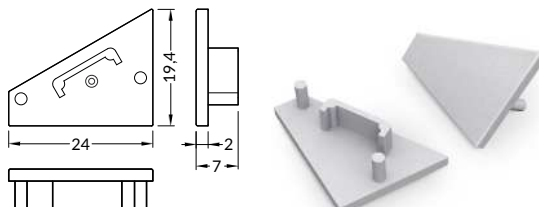

INDEX = 10 sets = 20 pcs
package > check the pricelist
INDEKS = 10 kpl = 20 szt.
opakowanie > patrz cennik

white / biały
A4980001
silver / srebrny
A4980040
black / czarny
A4980002
grey / szary
A4980022

CORNER14 ending gen2 with hole
colours: white, silver, black, grey
material: ABS

zaślepka CORNER14 gen2 z otworem
kolory: biały, srebrny, czarny, szary
materiał: ABS

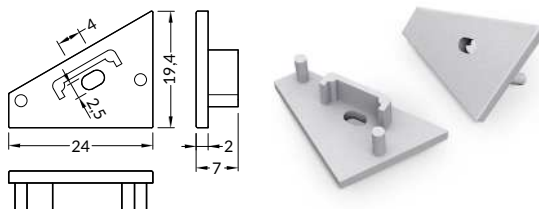

white / biały
A4970001
silver / srebrny
A4970040
black / czarny
A4970002
grey / szary
A4970022

CONNECTORS / ŁĄCZNIKI

T connector 180 deg
colour: raw aluminium
material: aluminium

łącznik **T** 180 st
kolor: surowe aluminium
materiał: aluminium

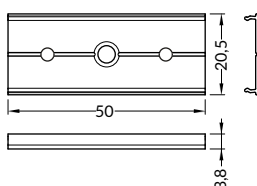

INDEX = 1 set
package > check the pricelist
INDEKS = 1 kpl = 20 szt.
opakowanie > patrz cennik

raw aluminium
surowe aluminium
C6990000

CORNER14 connector 90 deg
colours: white, anodized, black
material: aluminium

łącznik CORNER14 90 st
kolory: biały, anodowany, czarny
materiał: aluminium

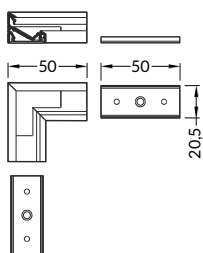

white painted
biały malowany
A4990001

anodized
anodowany
A4990020

black anodized
czarny anodowany
A4990021



CORNER27 G/UX

LARGE-SIZE ANGULAR PROFILE

WIELKOGABARYTOWY PROFIL KĄTOWY

- hidden mounting
- two lighting angles: 30° or 60°
- maximum LED strip width: 27 mm or 3 standard strips (8 mm)
- ukryte mocowanie
- dwa kąty świecenia: 30 i 60°
- maksymalna szerokość taśmy LED: 27 mm albo do 3 taśm standardowych (8 mm)



SIMILAR IN THE OFFER / PODOBNE W OFERCIE



TRIO10
BC



CORNER10
BC/UX



QUARTER10
BD/U6



CABI12
E



CORNER14
EF/TY



G slide cover
klosz G wsuwany

U¹ U flexible mounting plate
uchwyt U sprężysty

U² cone U flexible mounting plate
uchwyt U sprężysty cone

X¹ X mounting plate
uchwyt X

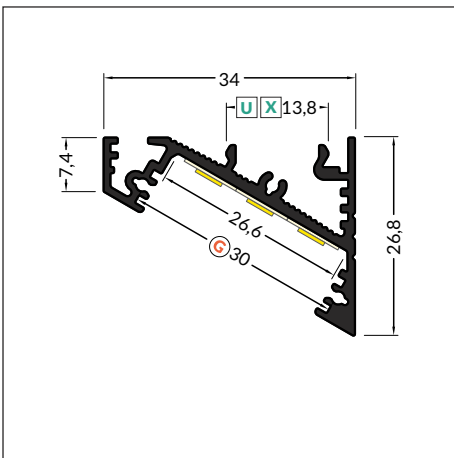
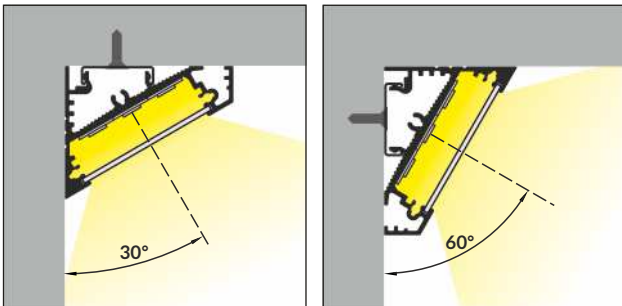
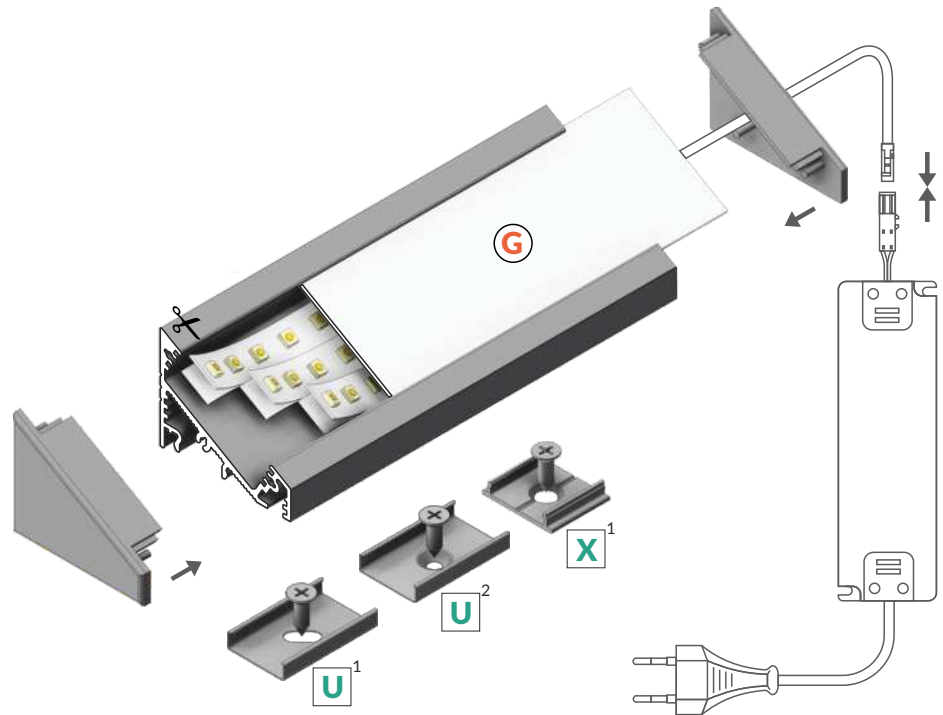

 max 27 mm

 corner
kątowy



INDEX = 1 pc, length 2000 mm
package > check the pricelist
INDEKS = 1 szt., długość 2000 mm
opakowanie > patrz cennik

white painted
biały malowany
98030001



anodized
anodowany
98030020



black anodized
czarny anodowany
98030021

Available lengths: 1000 mm, 2000 mm, 3000 mm, 4000 mm.
The standard profile length tolerance is +20 mm.
More details >> 1.08.

Dostępne długości: 1000 mm, 2000 mm, 3000 mm, 4000 mm.
Standardowa tolerancja długości profili wynosi: +20 mm.
Więcej informacji >> 1.08.



COVERS / KLOSZE

G slide cover
colours: transparent, frosted, opal
material: PC, PP, PP

klosz **G** wsuwany
kolory: przezroczysty, szron, mleczny
materiał: PC, PP, PP



Note! Dimensions of the space to install LED source
Uwaga! Wymiary przestrzeni do zamontowania źródła LED

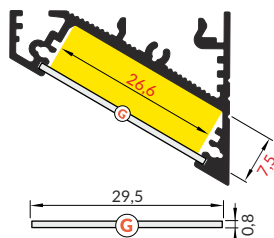

length 2000 mm
package > check the pricelist
długość 2000 mm
opakowanie > patrz cennik

G transparent / G transparentny
index = 10 pcs / indeks = 10 szt.
84070016

G frosted / G szron
index = 10 pcs / indeks = 10 szt.
84070039

G opal / G mleczny
index = 10 pcs / indeks = 10 szt.
84070038

The standard cover length tolerance is +20 mm.
More details >> 1.08.

Standardowa tolerancja długości klosza wynosi: +20 mm
Więcej informacji >> 1.08.

ENDINGS / ZAŚLEPKI

CORNER27 ending
colours: white, silver, black, grey
material: ABS

zaślepka CORNER27
kolory: biały, srebrny, czarny, szary
materiał: ABS

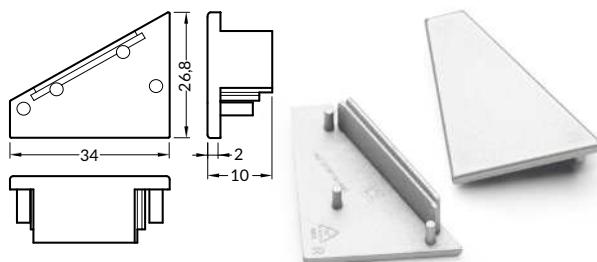

INDEX = 10 sets = 20 pcs
package > check the pricelist
INDEKS = 10 kpl = 20 szt.
opakowanie > patrz cennik

white / biały
98050001

silver / srebrny
98050040

black / czarny
98050002

grey / szary
98050022

MOUNTINGS / MOCOWANIA

U flexible mounting plate
colour: inox
material: stainless steel

uchwyt **U** sprężysty
kolor: inox
materiał: stal nierdzewna

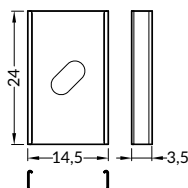
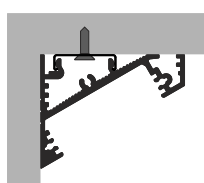

INDEX = 10 sets = 20 pcs
package > check the pricelist
INDEKS = 10 kpl = 20 szt.
opakowanie > patrz cennik

inox
76380000

cone U flexible mounting plate
colour: inox
material: stainless steel

uchwyt **U** sprężysty cone
kolor: inox
materiał: stal nierdzewna

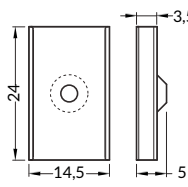
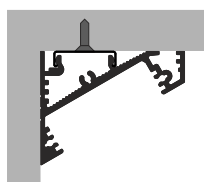

inox
76620000

X mounting plate
colour: raw aluminium
material: aluminium

uchwyt **X**
kolor: surowe aluminium
materiał: aluminium

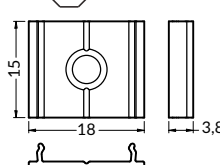
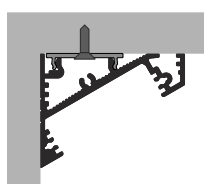

raw aluminium
surowe aluminium
76260000



CONNECTORS / ŁĄCZNIKI

X connector 180 deg
colour: raw aluminium
material: aluminium

łącznik X 180 st
kolor: surowe aluminium
materiał: aluminium

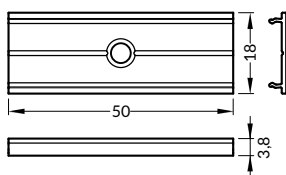

INDEX = 1 set
package > check the pricelist
INDEKS = 1 kpl
opakowanie > patrz cennik

raw aluminium
surowe aluminium
76350000





2020 LED PROFILES

PROFILE LED

SPECIAL APPLICATION / SPECJALNE



PEN8 |

MULTI-PURPOSE ALUMINIUM PROFILE

ALUMINOWY PROFIL UNIWERSALNY

- decorative and lighting profile, eg. for glass cabinets
 - 8 types of mountings: for horizontal or vertical lighting (also with adjustment)
 - possibility of mounting between the walls of a cabinet
 - maximum LED strip width: 8 mm
-
- profil dekoracyjno-oświetleniowy, np. do szklanych gablot
 - 8 rodzajów mocowań: do oświetlenia pionowego lub poziomego (również z regulacją)
 - możliwość mocowania pomiędzy ściankami
 - maksymalna szerokość taśmy LED: 8 mm

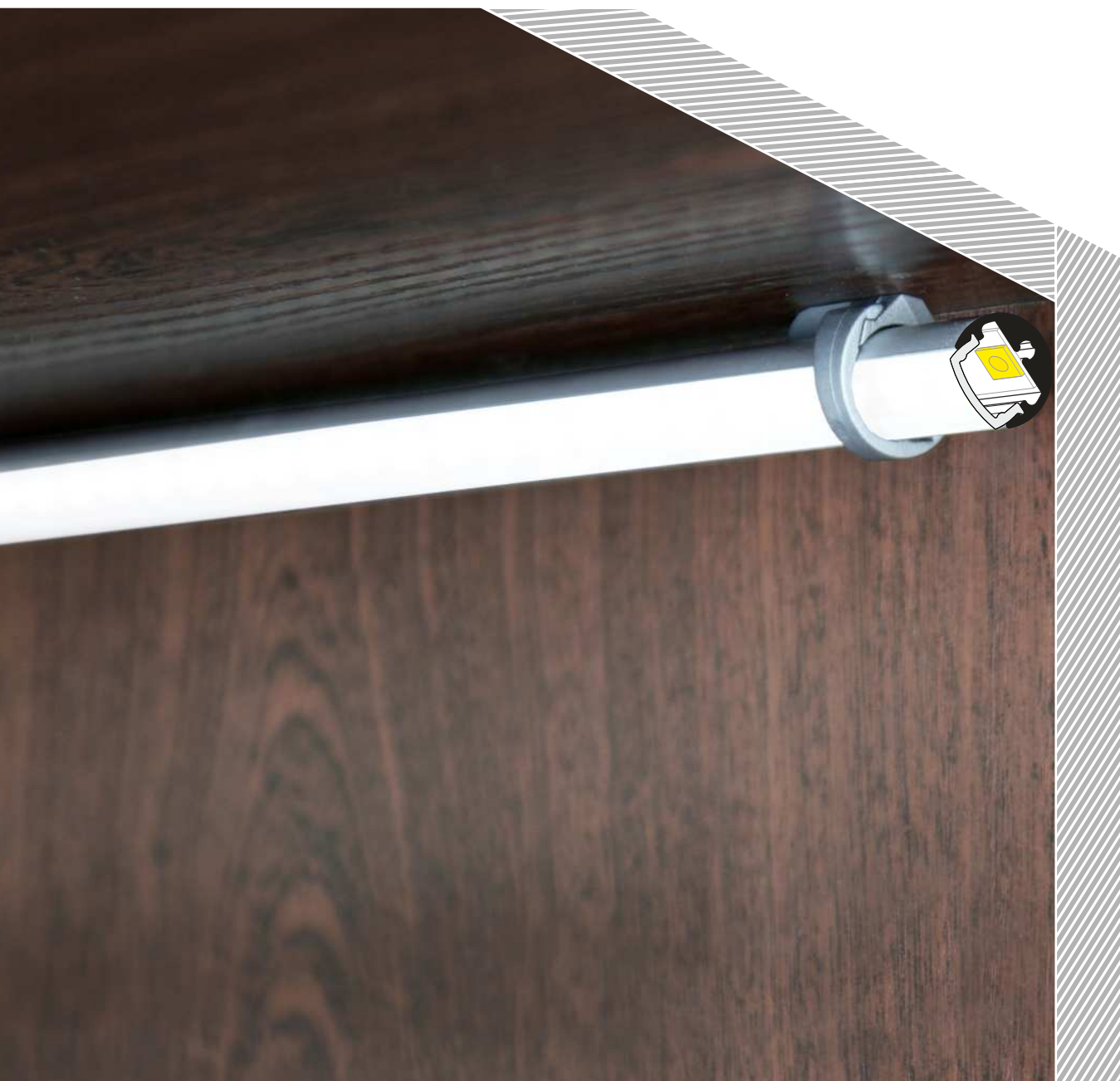

SIMILAR IN THE OFFER / PODOBNE W OFERCIE



PEN12
CJ



CABI12
E



CORNER10
BC/UX



TRIO10
BC



OVAL20
BC



 click cover
klosz | klik

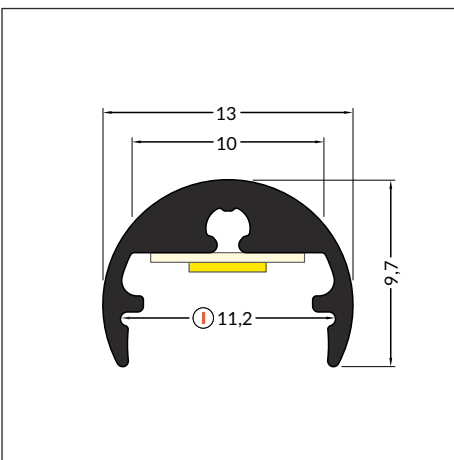
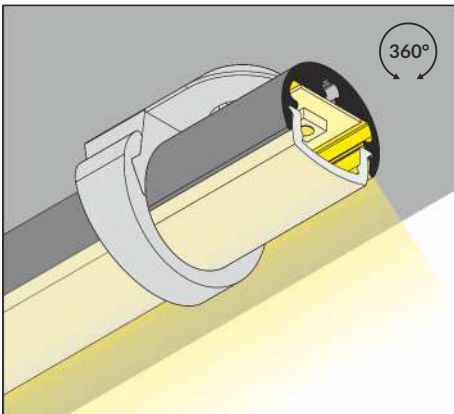
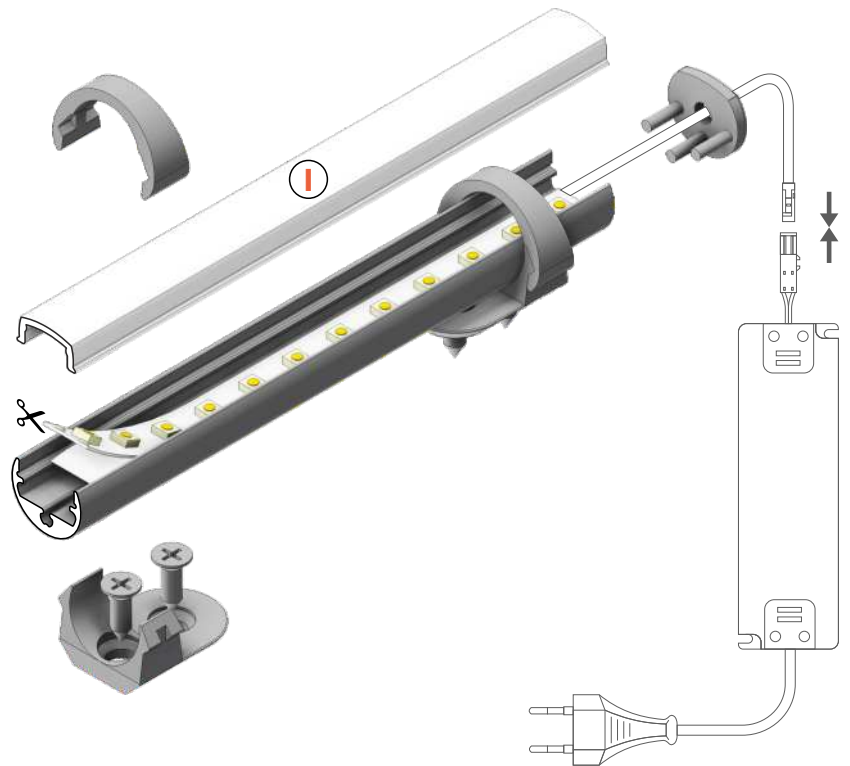

INDEX = 1 pc, length 2000 mm
package > check the pricelist
INDEKS = 1 szt., długość 2000 mm
opakowanie > patrz cennik

anodized
anodowany
86030020

Available lengths: 1000 mm, 2000 mm, 3000 mm, 4000 mm.
The standard profile length tolerance is +20 mm.
More details >> 1.08.

Dostępne długości: 1000 mm, 2000 mm, 3000 mm, 4000 mm.
Standardowa tolerancja długości profili wynosi: +20 mm.
Więcej informacji >> 1.08.

 max 8 mm

 special application
specjalny



COVERS / KLOSZE

I click cover
colour: frosted, opal
material: PC

klosz I klik
kolor: szron, mleczny
materiał: PC



Note! Dimensions of the space to install LED source
Uwaga! Wymiary przestrzeni do zamontowania źródła LED

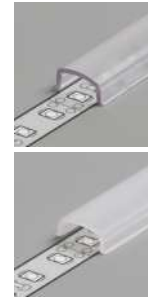
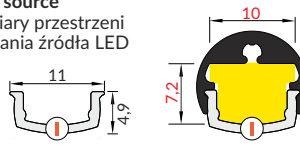

length 2000 mm
package > check the pricelist
długość 2000 mm
opakowanie > patrz cennik

I frosted / I szron
index = 1 pc / indeks = 1 szt.
86060000

I opal / I mleczny
index = 1 pc / indeks = 1 szt.
86060038

The standard cover length tolerance is +20 mm.
More details >> 1.08.

Standardowa tolerancja długości kloszy wynosi: +20 mm
Więcej informacji >> 1.08.

ENDINGS / ZAŚLEPKI

PEN8 ending
colours: silver, grey
material: ABS

zaślepka PEN8
kolory: srebrny, szary
materiał: ABS

PEN8 ending with hole
colours: silver, grey
material: ABS

zaślepka PEN8 z otworem
kolory: srebrny, szary
materiał: ABS

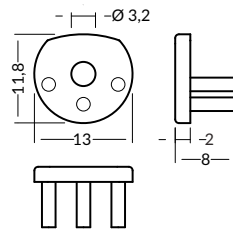

INDEX = 1 set
package > check the pricelist
INDEKS = 1 kpl
opakowanie > patrz cennik

silver / srebrny
86490040

grey / szary
86490022

silver / srebrny
86470040

grey / szary
86470022

MOUNTINGS / MOCOWANIA

PEN8 flat holder
colour: grey
material: ABS

uchwyt PEN8 płaski
kolor: szary
materiał: ABS

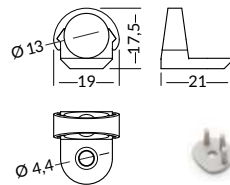
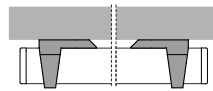

INDEX = 10 sets = 20 pcs
package > check the pricelist
INDEKS = 10 kpl = 20 szt.
opakowanie > patrz cennik

grey
szary
86070022

PEN8 simple holder
material: zinc coated steel

uchwyt PEN8 prosty
materiał: stal ocynkowana

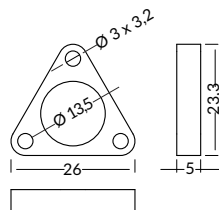
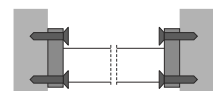

INDEX = 1 set = 2 pcs
package > check the pricelist
INDEKS = 1 kpl = 2 szt.
opakowanie > patrz cennik

zinc coated
stal ocynkowana
86370030

PEN8 ring holder
colours: chrome, raw
material: brass

uchwyt PEN8 ring
kolory: chrom, surowy
materiał: mosiądz

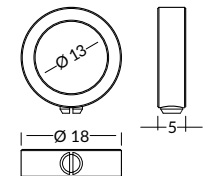
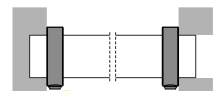

chrome
chrom
86440003

PEN8 stretcher holder
colour: chrome
material: brass

uchwyt PEN8 rozporowy
kolor: chrom
materiał: mosiądz

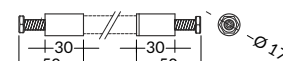
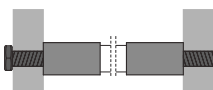

chrome
chrom
86290003

PEN8 end holder
colour: chrome
material: brass

uchwyt PEN8 końcowy
kolor: chrom
materiał: mosiądz

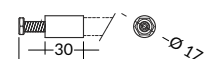
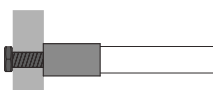

INDEX = 1 set = 1 pc
package > check the pricelist
INDEKS = 1 kpl = 1 szt.
opakowanie > patrz cennik

chrome
chrom
86160003



MOUNTINGS / MOCOWANIA

PEN8 jointed holder with soffit ceiling
colour: chrome
material: steel, brass

uchwyt PEN8 przegubowy z podsufitką
kolor: chrom
materiał: stal, mosiądz

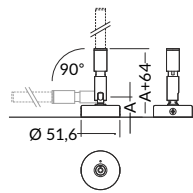

PEN8 double holder with thread
colour: chrome
material: steel, brass

uchwyt PEN8 podwójny z gwintem
kolor: chrom
materiał: stal, mosiądz

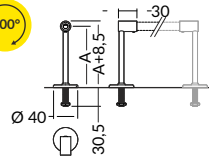

PEN8 double holder with soffit ceiling
colour: chrome
material: steel, brass

uchwyt PEN8 podwójny z podsufitką
kolor: chrom
materiał: stal, mosiądz

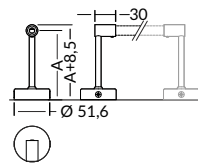

INDEX = 1 set = 1 pc
package > check the pricelist
INDEKS = 1 kpl = 1 szt.
opakowanie > patrz cennik

A =

27 mm	86080003
100 mm	86300003
200 mm	86100003
300 mm	86120003

INDEX = 1 set = 2 pcs
package > check the pricelist
INDEKS = 1 kpl = 2 szt.
opakowanie > patrz cennik

A =

100 mm	86330003
200 mm	86180003
300 mm	86200003

INDEX = 1 set = 2 pcs
package > check the pricelist
INDEKS = 1 kpl = 2 szt.
opakowanie > patrz cennik

A =

100 mm	86320003
200 mm	86170003
300 mm	86190003

Photo / Zdjęcie:
PORSÁ - Systemy Meblowe Mirosław Krysiak



BACK10 A/UX

TWO LIGHTING DIRECTIONS

DWA KIERUNKI ŚWIECENIA

- decorative illumination
 - the T-shaped structure makes possible to direct the light beam in two directions (up/down, left/right)
 - mounting with two dedicated holders (to the wall) or directly to the piece of furniture, using screws
 - optionally, the A cover can be used
 - maximum LED strip width: 10 mm
-
- oświetlenie dekoracyjne
 - konstrukcja w kształcie litery "T" pozwala na skierowanie strumienia świetlnego w dwóch kierunkach (góra/dół, lewo/prawo)
 - mocowanie za pomocą dedykowanych uchwytów (do ściany) lub bezpośrednio przy pomocy wkrętów (do mebla)
 - opcjonalne użycie klosza A
 - maksymalna szerokość taśmy LED: 10 mm

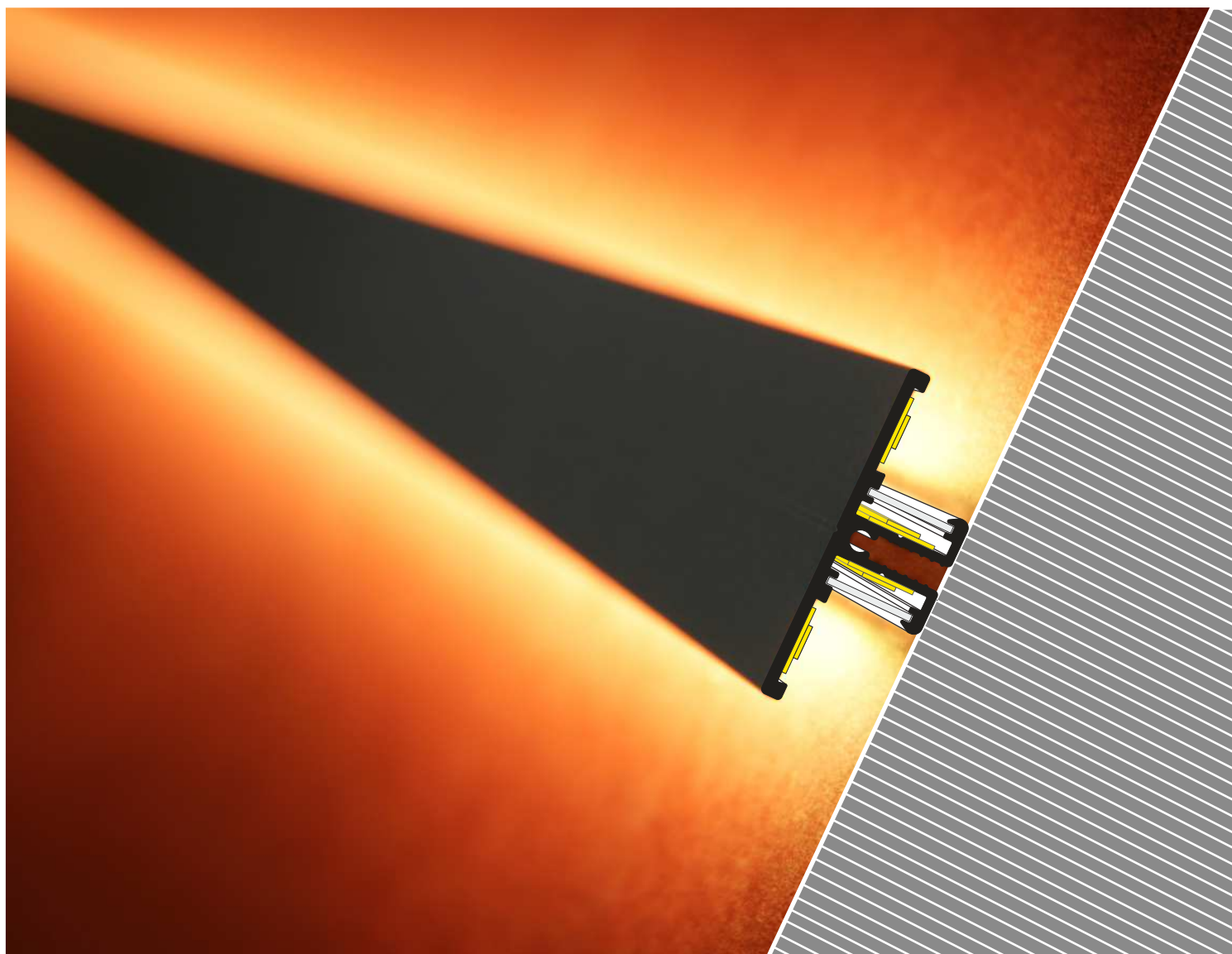

SIMILAR IN THE OFFER / PODOBNE W OFERCIE



TWIN8



WALLE12
CD



- A** slide cover
klosz A wsuwany
- U**¹ flexible mounting plate
uchwyt U sprężysty
- U**² cone U flexible mounting plate
uchwyt U sprężysty cone
- X**¹ mounting plate
uchwyt X

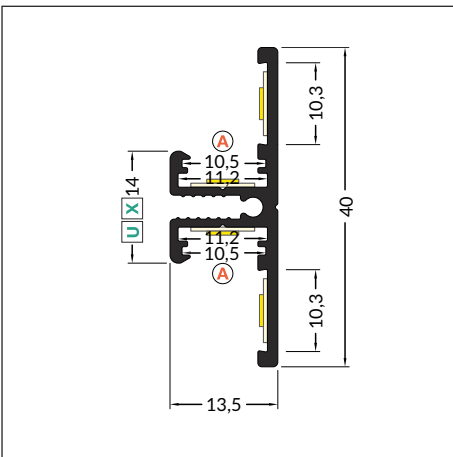
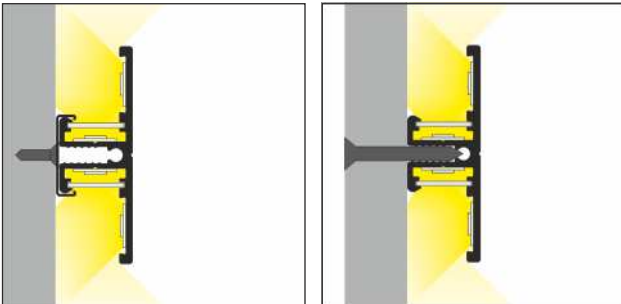
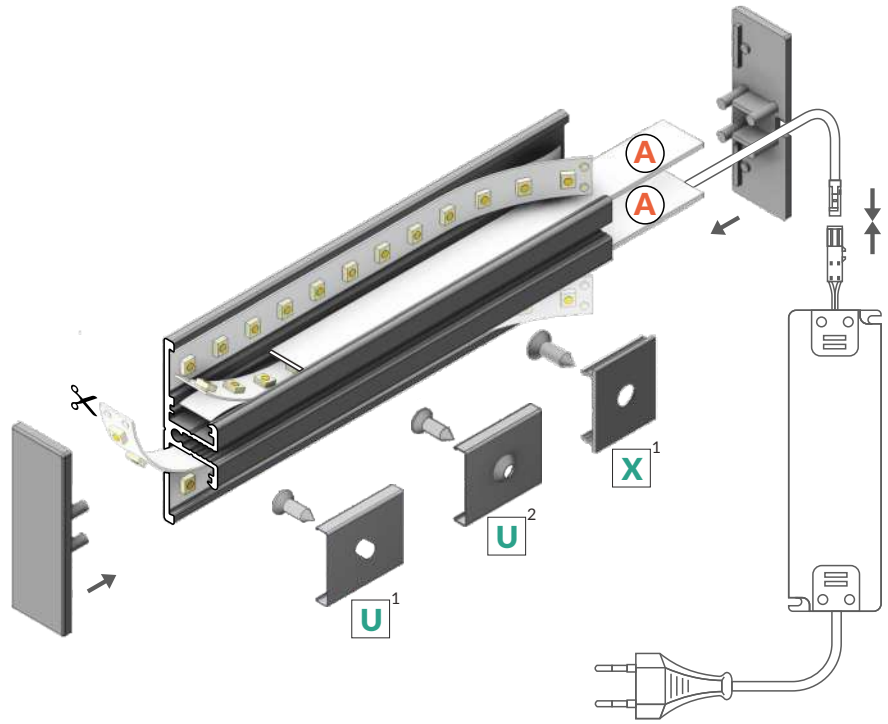

max 10 mm



special application
specjalny



INDEX = 1 pc, length 2000 mm
package > check the pricelist
INDEKS = 1 szt., długość 2000 mm
opakowanie > patrz cennik

white painted
biały malowany
90030001

anodized
anodowany
90030020

black painted
czarny malowany
90030002

raw aluminium
surowe aluminium
90030000

Available lengths: 1000 mm, 2000 mm, 3000 mm, 4000 mm.
The standard profile length tolerance is +20 mm.
More details >> 1.08.

Dostępne długości: 1000 mm, 2000 mm, 3000 mm, 4000 mm.
Standardowa tolerancja długości profili wynosi: +20 mm.
Więcej informacji >> 1.08.



COVERS / KLOSZE

A slide cover

colours: transparent, frosted, opal
material: PC, PP, PP

klosz A wsuwany
kolory: transparentny, szron, mleczny
materiał: PC, PP, PP

Note! Dimensions of the space to install LED source
Uwaga! Wymiary przestrzeni do zamontowania źródła LED

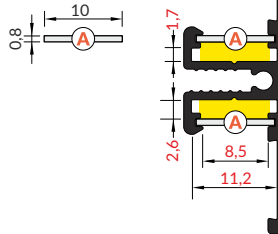

length 2000 mm
package > check the pricelist
długość 2000 mm
opakowanie > patrz cennik

A transparent / A transparentny
index = 10 pcs / indeks = 10 szt.
89070016

A frosted / A szron
index = 10 pcs / indeks = 10 szt.
89070039

A opal / A mleczny
index = 10 pcs / indeks = 10 szt.
89070038

The standard cover length tolerance is +20 mm.
More details >> 1.08.

Standardowa tolerancja długości klosza wynosi: +20 mm
Więcej informacji >> 1.08.

ENDINGS / ZAŚLEPKI

BACK10 ending

colours: white, silver, black, grey
material: ABS

zaślepka BACK10
kolory: biały, srebrny, czarny, szary
materiał: ABS

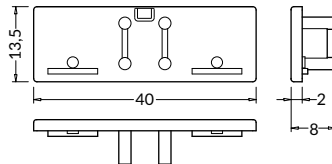

INDEX = 10 sets = 20 pcs
package > check the pricelist
INDEKS = 10 kpl = 20 szt.
opakowanie > patrz cennik

white / biały
90100001

silver / srebrny
90100040

black / czarny
90100002

grey / szary
90100022

BACK10 ending with hole

colours: white, silver, black, grey
material: ABS

zaślepka BACK10 z otworem
kolory: biały, srebrny, czarny, szary
materiał: ABS

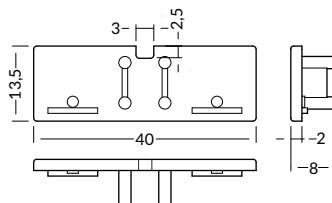

white / biały
90150001

silver / srebrny
90150040

black / czarny
90150002

grey / szary
90150022

MOUNTINGS / MOCOWANIA

U flexible mounting plate

colour: inox
material: stainless steel

uchwyt U sprężysty
kolor: inox
materiał: stal nierdzewna

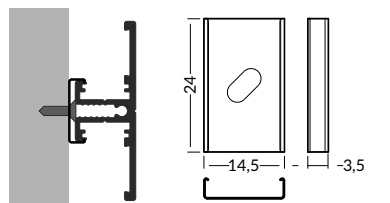

INDEX = 10 sets = 20 pcs
package > check the pricelist
INDEKS = 10 kpl = 20 szt.
opakowanie > patrz cennik

inox
76380000

cone U flexible mounting plate

colour: inox
material: stainless steel

uchwyt U sprężysty cone
kolor: inox
materiał: stal nierdzewna

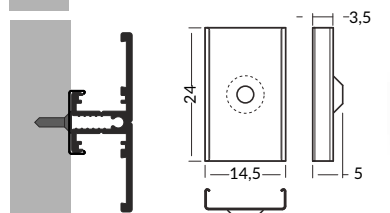

inox
76620000

X mounting plate
colour: raw aluminium
material: aluminium

uchwyt X
kolor: surowe aluminium
materiał: aluminium

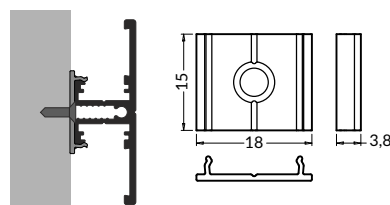

raw aluminium
surowe aluminium
76260000



CONNECTORS / ŁĄCZNIKI

X connector 180 deg
colour: raw aluminium
material: aluminium

łącznik X 180 st
kolor: surowe aluminium
materiał: aluminium

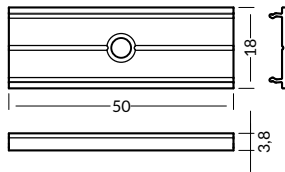

INDEX = 1 set
package > check the pricelist
INDEKS = 1 kpl
opakowanie > patrz cennik

raw aluminium
surowe aluminium
76350000



STEP10 C

STEP EDGE PROFILE

PROFIL SCHODOWY KRAWĘDZIOWY

- highlighting or illuminating feature
- 2 mounting options - 3 lighting options to choose from
- anti slip insert installation option
- hidden mounting
- impact resistant
- maximum LED strip width: 10 mm

- typ akcentujący lub oświetleniowy
- 2 opcje montażu - 3 opcje świecenia do wyboru
- opcja montażu wkładki antypoślizgowej
- ukryte mocowanie
- odporny na udary
- maksymalna szerokość taśmy LED: 10 mm

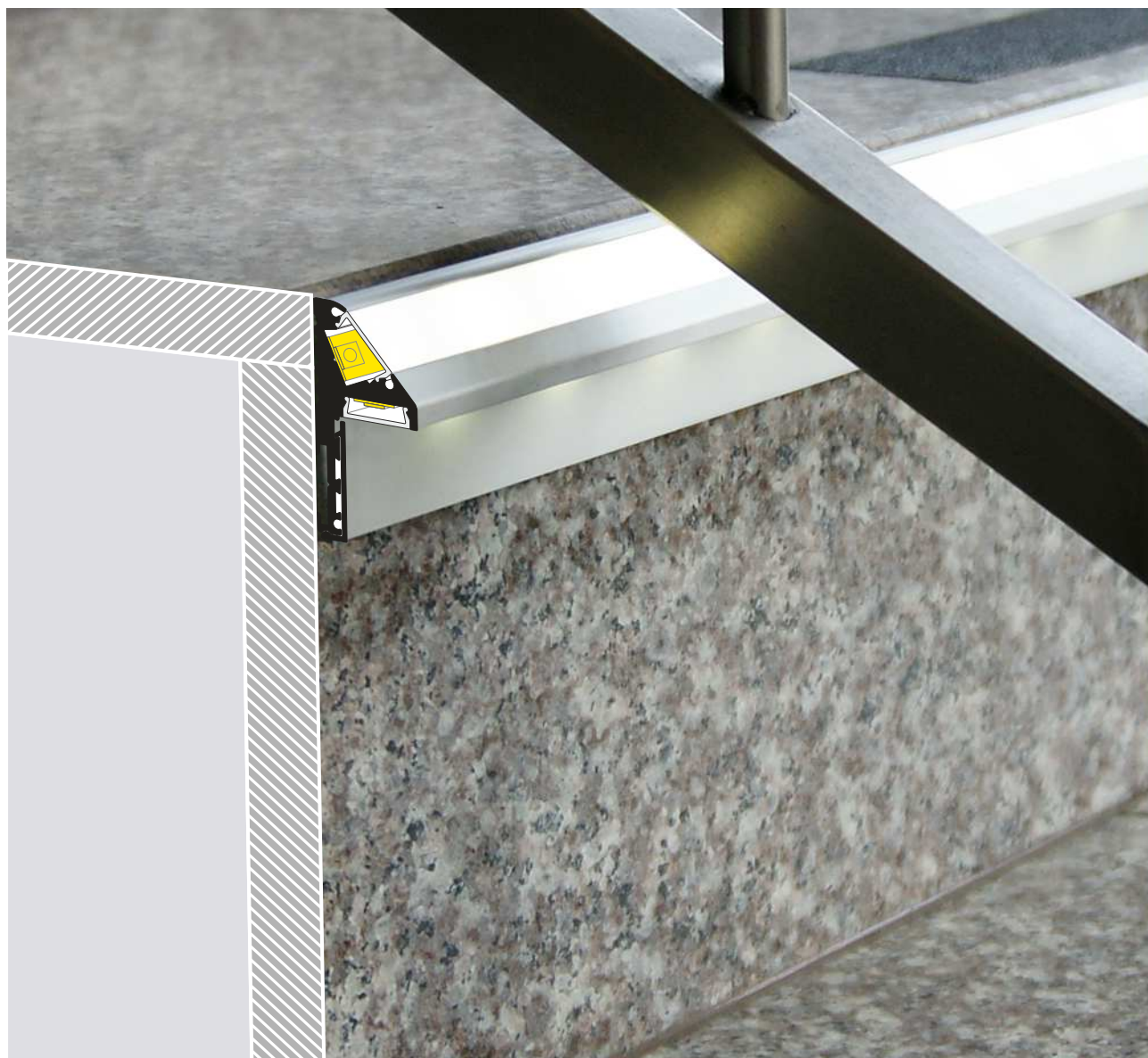

SIMILAR IN THE OFFER / PODOBNE W OFERCIE



C click cover
klosz C klik

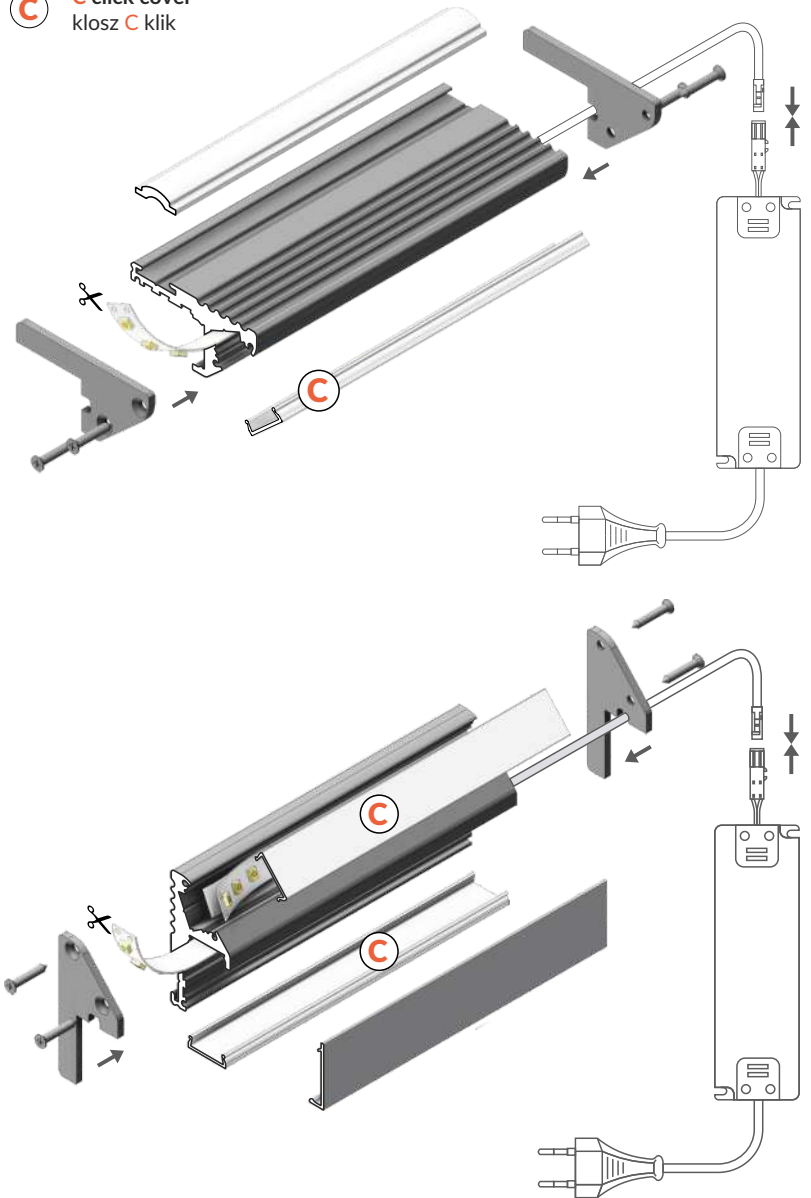
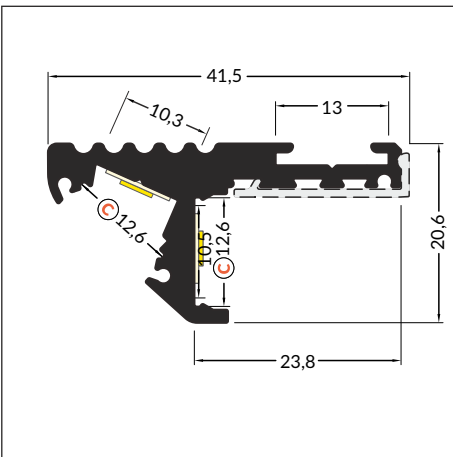
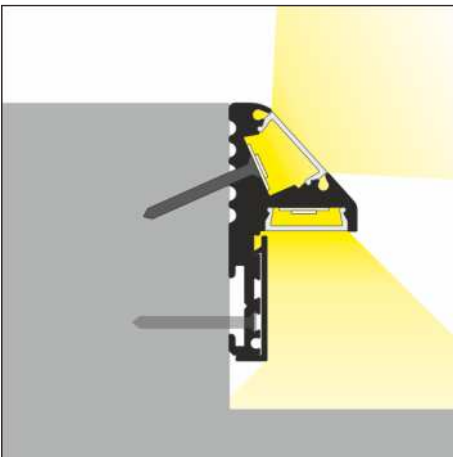
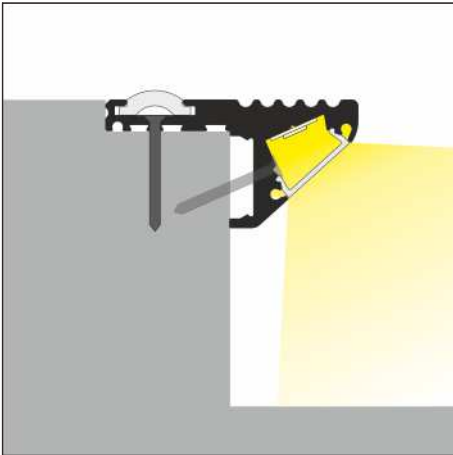

max 10 mm



special application
specjalny



INDEX = 1 pc, length 2000 mm
package > check the pricelist
INDEKS = 1 szt., długość 2000 mm
opakowanie > patrz cennik

anodized
anodowany
32080020

black anodized
czarny anodowany
32080021

Available lengths: 1000 mm, 2000 mm, 3000 mm, 4000 mm.
The standard profile length tolerance is +20 mm.
More details >> 1.08.

Dostępne długości: 1000 mm, 2000 mm, 3000 mm, 4000 mm.
Standardowa tolerancja długości profilu wynosi: +20 mm.
Więcej informacji >> 1.08.



COVERS / KLOSZE

C click cover
colours: transparent, opal
material: PMMA
klosz C klik
kolory: transparentny, mleczny
materiał: PMMA



Note! Dimensions of the space to install LED source
Uwaga! Wymiary przestrzeni do zamontowania źródła LED

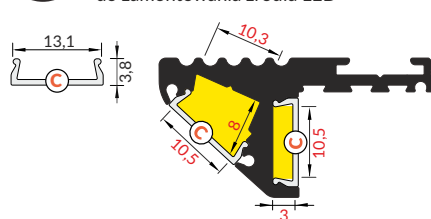

length 2000 mm
package > check the pricelist
długość 2000 mm
opakowanie > patrz cennik

C transparent / C transparentny
index = 1 pc / indeks = 1 szt.
76330000

C opal / C mleczny
index = 1 pc / indeks = 1 szt.
76330038



reel, length 20 m
package > check the pricelist
rolka, długość 20 m
opakowanie > patrz cennik

C opal / C mleczny
index = 1 pc / indeks = 1 szt.
76360038S

The standard cover length tolerance is +20 mm.
More details >> 1.08.

Standardowa tolerancja długości kloszy wynosi: +20 mm
Więcej informacji >> 1.08.

ENDINGS / ZAŚLEPKI

STEP10 ending
colours: silver
material: steel
zaślepka STEP10
kolory: srebrny
materiał: stal

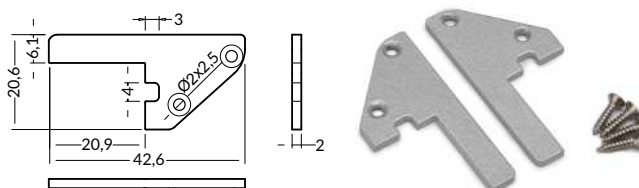

INDEX = 1 set = 2 pcs
package > check the pricelist
INDEKS = 1 kpl = 2 szt.
opakowanie > patrz cennik

silver
srebrny
32100022

black
czarny
32100002

COVER / OSŁONA

STEP10 LED cover
colours: anodized
material: aluminium
osłona LED STEP10
kolory: anodowany
materiał: aluminium

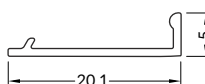

INDEX = 1 pc, length 2000 mm
package > check the pricelist
INDEKS = 1 szt., długość 2000 mm
opakowanie > patrz cennik

anodized
anodowany
32120020

black anodized
czarny anodowany
32120021

Available lengths: 1000 mm, 2000 mm, 3000 mm, 4000 mm.
The standard profile length tolerance is +20 mm.
More details >> 1.08.

Dostępne długości: 1000 mm, 2000 mm, 3000 mm, 4000 mm.
Standardowa tolerancja długości profili wynosi: +20 mm.
Więcej informacji >> 1.08.

INSERT / WKŁADKA

STEP10 anti slip insert
colours: transparent
wkładka antypoślizgowa STEP10
kolory: transparentny



INDEX = 1 pc, length 2000 mm
package > check the pricelist
INDEKS = 1 szt., długość 2000 mm
opakowanie > patrz cennik

transparent
transparentny
32150000

black
czarny
32150002

1. Illuminating a step with anti slip insert applied.

1. Oświetlenie stopnia oraz zastosowanie wkładki antypoślizgowej.



2. Illuminating a step and edge highlighting.

2. Oświetlenie stopnia oraz zaakcentowanie krawędzi.



WAY10 C

STRIP FOR ILLUMINATING PASSAGEWAYS

LISTWA DO PODŚWIETLANIA CIĄGÓW KOMUNIKACYJNYCH

- dedicated for wall mounting
- hidden mounting and wiring
- curved shape
- maximum LED strip width: 10 mm
- dedykowany do montażu ściennego
- ukryte mocowanie i przewody
- obła forma
- maksymalna szerokość taśmy LED: 10 mm



SIMILAR IN THE OFFER / PODOBNE W OFERCIE



WALLE12
CD



BACK10
A/UX

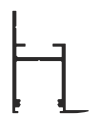

FRAME14
BC/Q



C click cover
klosz **C** klik

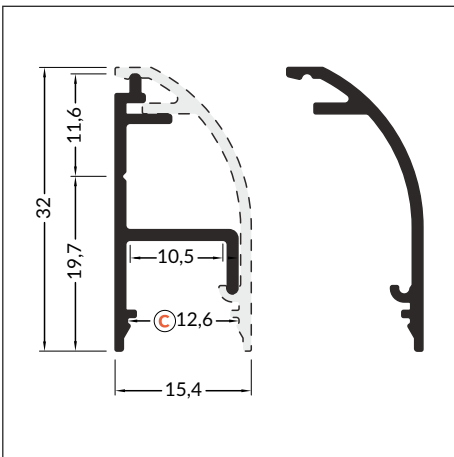
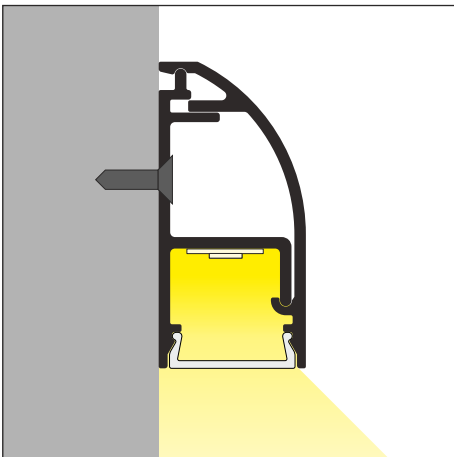
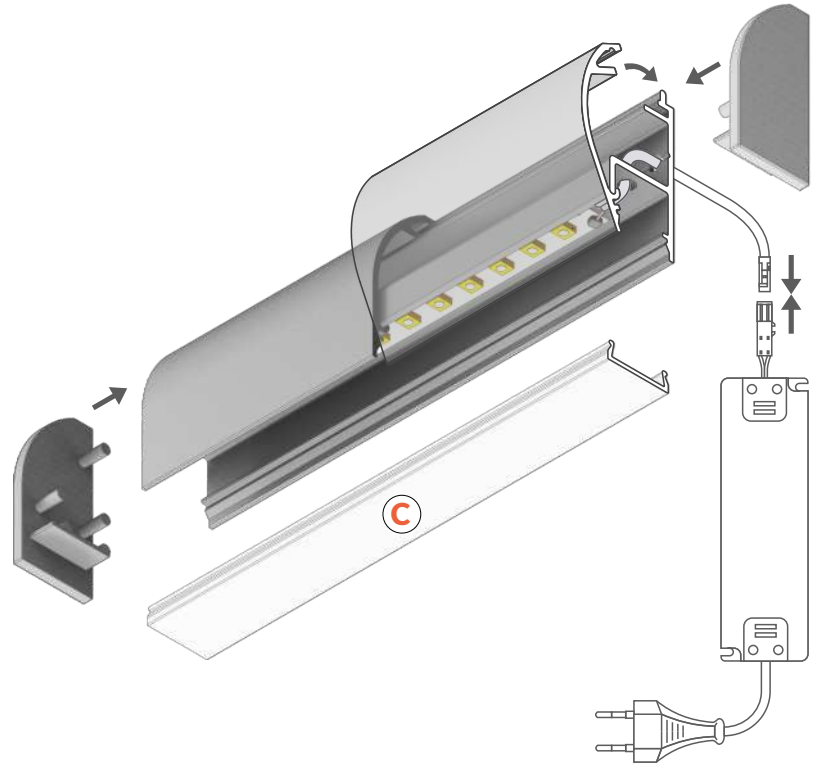

max 10 mm



special application
specjalny

INDEX = 1 pc, length 2000 mm
package > check the pricelist
INDEKS = 1 szt., długość 2000 mm
opakowanie > patrz cennik

anodized
anodowany
F9000220



Available lengths: 1000 mm, 2000 mm, 3000 mm, 4000 mm.
The standard profile length tolerance is +20 mm.
More details >> 1.08.

Dostępne długości: 1000 mm, 2000 mm, 3000 mm, 4000 mm.
Standardowa tolerancja długości profili wynosi: +20 mm.
Więcej informacji >> 1.08.



COVERS / KLOSZE

C click cover
colours: transparent, opal
material: PMMA
klosz **C** klik
kolory: transparentny, mleczny
materiał: PMMA



Note! Dimensions of the space to install LED source
Uwaga! Wymiary przestrzeni do zamontowania źródła LED

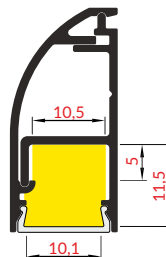
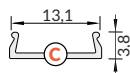

length 2000 mm
package > check the price list
długość 2000 mm
opakowanie > patrz cennik

C transparent / C transparentny
index = 1 pc / indeks = 1 szt.
76330000

C opal / C mleczny
index = 1 pc / indeks = 1 szt.
76330038



reel, length 20 m
package > check the pricelist
rolka, długość 20 m
opakowanie > patrz cennik

C opal / C mleczny
index = 1 pc / indeks = 1 szt.
76360038S

The standard cover length tolerance is +20 mm.
More details >> 1.08.

Standardowa tolerancja długości kloszy wynosi: +20 mm
Więcej informacji >> 1.08.

ENDINGS / ZAŚLEPKI

WAY10 ending
colours: white, silver, black, grey
material: ABS
zaślepka WAY10
kolory: biały, srebrny, czarny, szary
materiał: ABS

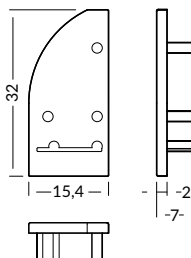

Ending with marked space to bore the holes.
Zaślepka z punktami do przewiercenia otworów.

INDEX = 10 sets = 20 pcs
package > check the pricelist
INDEKS = 10 kpl = 20 szt.
opakowanie > patrz cennik

white
biały
F9009901

silver
srebrny
F9009940

black
czarny
F9009902

grey
szary
F9009922

COVER / OSŁONA

WAY10 LED cover
colours: white, anodized, black, raw aluminium
material: aluminium
osłona LED WAY10
kolory: biały, anodowany, czarny, surowe aluminium
materiał: aluminium

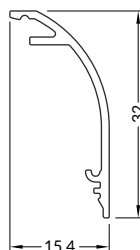

INDEX = 1 pc, length 2000 mm
package > check the pricelist
INDEKS = 1 szt., długość 2000 mm
opakowanie > patrz cennik

white painted
biały malowany
F9000601

anodized
anodowany
F9000620

black painted
czarny malowany
F9000602

raw aluminium
surowe aluminium
F9000600

Available lengths: 1000 mm, 2000 mm, 3000 mm, 4000 mm.
The standard profile length tolerance is +20 mm.
More details >> 1.08.

Dostępne długości: 1000 mm, 2000 mm, 3000 mm, 4000 mm.
Standardowa tolerancja długości profili wynosi: +20 mm.
Więcej informacji >> 1.08.



ARC12 CD/U5

FLEXIBLE ALUMINIUM LED PROFILE

ALUMINIOWY PROFIL LED DO ZASTOSOWAŃ GIĘTYCH

- flexible aluminium profile - possibility of bending in two directions
 - the profile keeps shaped bend
 - minimal bending radius: 50 cm
 - decorative and illuminating purpose of the profile
 - possibility of using two diffusers – better light dispersion
 - possible outside installation (with D cover and waterproof LED strip used)
 - maximum LED strip width: 12 mm
-
- aluminiowy profil do zastosowań giętych w dwóch kierunkach jednej płaszczyzny
 - profil zachowujący kształt wygięcia
 - minimalny promień gięcia: 50 cm
 - profil dekoracyjno-oświetleniowy
 - możliwość założenia dwóch kloszy - lepsze rozproszenie światła
 - możliwość montażu zewnętrznego (przy zastosowaniu klosza D oraz taśmy wodoodpornej)
 - maksymalna szerokość taśmy LED: 12 mm



SIMILAR IN THE OFFER / PODOBNE W OFERCIE

SLIM8
AC2/Z

SMART10
AC2/Z

BEGTON12
J/S

UNI12
BCD/U



C C click cover
klosz C klik

D D click cover
klosz D klik

U5¹ cone U5 mounting plate
uchwyt U5 cone

U5² side U5 mounting plate
uchwyt U5 boczny

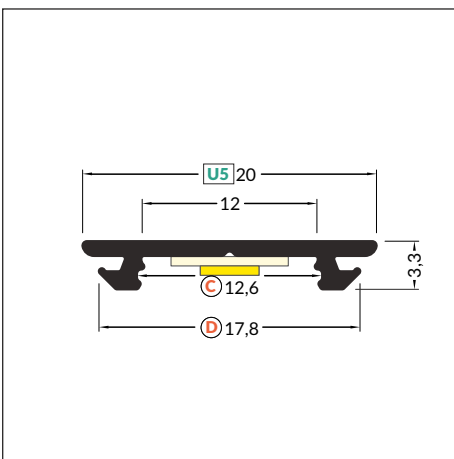
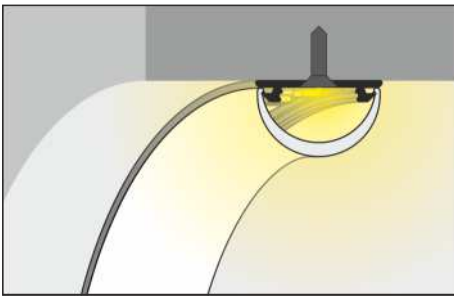
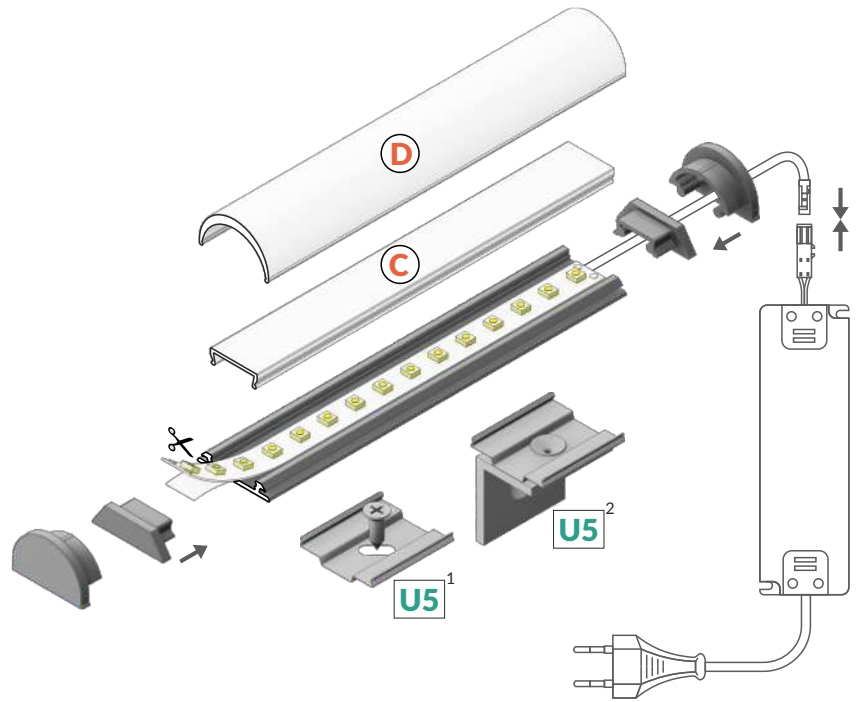

 max 12 mm

 special application
specjalny



INDEX = 1 pc, length 2000 mm
package > check the pricelist
INDEKS = 1 szt., długość 2000 mm
opakowanie > patrz cennik

white painted
biały malowany
B2010001



anodized
anodowany
B2010020

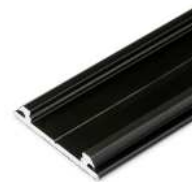

black painted
czarny malowany
B2010002



raw aluminium
surowe aluminium
B2010000

Available lengths: 1000 mm, 2000 mm, 3000 mm, 4000 mm.
The standard profile length tolerance is +20 mm.
More details >> 1.08.

Dostępne długości: 1000 mm, 2000 mm, 3000 mm, 4000 mm.
Standardowa tolerancja długości profili wynosi: +20 mm.
Więcej informacji >> 1.08.



COVERS / KLOSZE

C click cover
colours: transparent, opal
material: PMMA

klosz **C** klik
kolory: transparentny, mleczny
materiał: PMMA



Note! Dimensions of the space to install LED source
Uwaga! Wymiary przestrzeni do zamontowania źródła LED

Maximum LED strip width while using C cover: 10 mm
Maksymalna szerokość taśmy przy użyciu klosza C: 10 mm

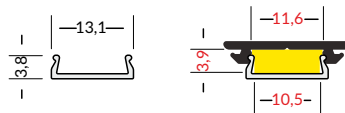

length 2000 mm
package > check the pricelist
długość 2000 mm
opakowanie > patrz cennik

C transparent / C transparentny
index = 1 pc / indeks = 1 szt.

76330000

C opal / C mleczny
index = 1 pc / indeks = 1 szt.

76330038

D click cover
colour: opal
material: PMMA

klosz **D** klik
kolor: mleczny
materiał: PMMA

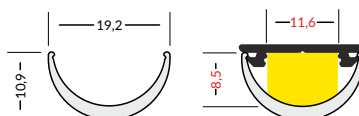

reel, length 20 m
package > check the pricelist
rolka, długość 20 m
opakowanie > patrz cennik

C opal / C mleczny
index = 1 pc / indeks = 1 szt.

76360038S



length 2000 mm
package > check the pricelist
długość 2000 mm
opakowanie > patrz cennik

D opal / D mleczny
index = 1 pc / indeks = 1 szt.

A1140038

The standard cover length tolerance is +20 mm.
More details >> 1.08.

Standardowa tolerancja długości kloszy wynosi: +20 mm
Więcej informacji >> 1.08.

ENDINGS / ZAŚLEPKI

ARC12 ending
colours: white, silver, black, grey
material: ABS

zaślepka ARC12
kolory: biały, srebrny, czarny, szary
materiał: ABS



Ending with marked space to bore the holes.
Zaślepka z punktami do przewiercenia otworów.

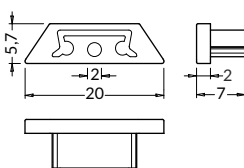

ARC12 D ending
colours: white, silver, black, grey
material: ABS

zaślepka ARC12 D
kolory: biały, srebrny, czarny, szary
materiał: ABS

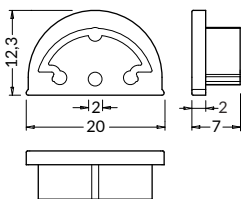

INDEX = 10 sets = 20 pcs
package > check the pricelist
INDEKS = 10 kpl = 20 szt.
opakowanie > patrz cennik

white / biały
B2960001

silver / srebrny
B2960040

black / czarny
B2960002

grey / szary
B2960022

white / biały
B2980001

silver / srebrny
B2980040

black / czarny
B2980002

grey / szary
B2980022

MOUNTINGS / MOCOWANIA

cone **U5** mounting plate
colour: inox
material: stainless steel

uchwyt **U5** cone
kolor: inox
materiał: stal nierdzewna

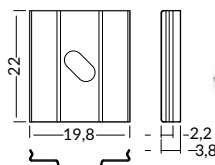

INDEX = 10 sets = 20 pcs
package > check the pricelist
INDEKS = 10 kpl = 20 szt.
opakowanie > patrz cennik

inox
B2940019

side **U5** mounting plate
colours: white, silver, black
material: stainless steel, aluminium

uchwyt **U5** boczny
kolory: biały, srebrny, czarny
materiał: stal nierdzewna, aluminium

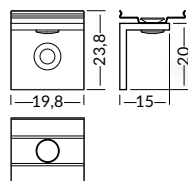
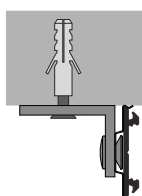

white / biały
B2920001

silver / srebrny
B2920022

black / czarny
B2920002



SLING / ZAWIESIE

SELV sling 50 V 1500
colour: white, silver, black
zawiesie SELV 50 V 1500
kolor: biały, srebrny, czarny



INDEX = 1 set = 2 pcs
package > check the pricelist
INDEKS = 1 kpl = 2 szt.
opakowanie > patrz cennik

white / biały
67120001

silver / srebrny
67120022

black / czarny
67120002



FIX12 / FIX16



THE SIMPLEST INSTALLATION OF A LED STRIP

NAJPROSTSZE MOCOWANIE TAŚMY LED

- function of radiator
- improves LED strip's adhesion
- minimal height of the profile
- budget profile, to be used without a cover
- maximum width of LED strip: 12 mm (FIX12) and 16 mm (FIX16)
- it can also function as a mounting profile:
FIX12 for profiles with X socket
FIX16 for profiles with T socket
- funkcja radiatora
- trwalsze przyleganie taśmy LED
- minimalna wysokość profilu
- profil budżetowy, do użycia bez klosza
- maksymalna szerokość taśmy LED: 12 mm (FIX12) oraz 16 mm (FIX16)
- może pełnić również funkcję montażową:
FIX12 dla profili z gniazdem X
FIX16 dla profili z gniazdem T



SIMILAR IN THE OFFER / PODOBNE W OFERCIE



SLIM8
AC2/Z



SMART10
AC2/Z



SURFACE10
BC/UX



BEGTON12
J/S



ARC12
CD/R



SURFACE14
EF/TY

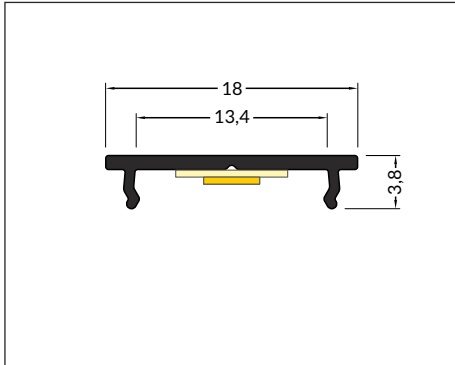
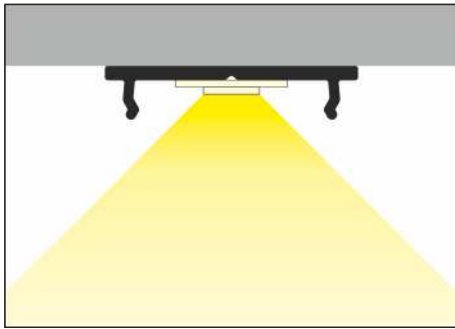

max 12 mm



special application
specjalny



mounting with screws
or adhesive tape
montaż na wkręty
albo taśmę dwustronną



INDEX = 1 pc, length 2000 mm
package > check the pricelist
INDEKS = 1 szt., długość 2000 mm
opakowanie > patrz cennik

anodized
anodowany
87030020



raw aluminium
surowe aluminium
87030000

Available lengths: 1000 mm, 2000 mm, 3000 mm, 4000 mm.
The standard profile length tolerance is +20 mm.
More details >> 1.08.

Dostępne długości: 1000 mm, 2000 mm, 3000 mm, 4000 mm.
Standardowa tolerancja długości profili wynosi: +20 mm.
Więcej informacji >> 1.08.

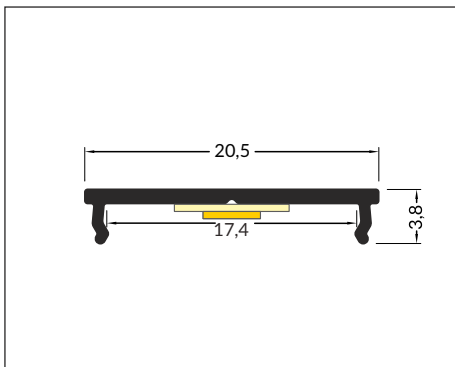
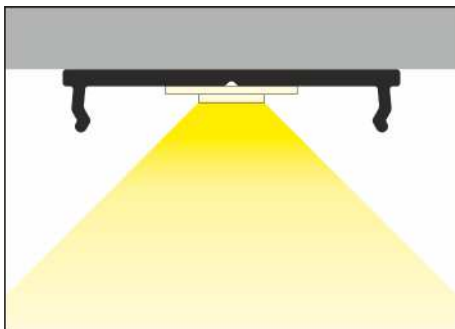

max 16 mm



special application
specjalny



mounting with screws
or adhesive tape
montaż na wkręty
albo taśmę dwustronną



INDEX = 1 pc, length 2000 mm
package > check the pricelist
INDEKS = 1 szt., długość 2000 mm
opakowanie > patrz cennik

white painted
biały malowany
C6020001



anodized
anodowany
C6020020



black anodized
czarny anodowany
C6020021



raw aluminium
surowe aluminium
C6020000

Available lengths: 1000 mm, 2000 mm, 3000 mm, 4000 mm.
The standard profile length tolerance is +20 mm.
More details >> 1.08.

Dostępne długości: 1000 mm, 2000 mm, 3000 mm, 4000 mm.
Standardowa tolerancja długości profili wynosi: +20 mm.
Więcej informacji >> 1.08.

WALLE12 BCD

WALL-MOUNTED PROFILE

PROFIL DO MONTAŻU ŚCIENNEGO

- mounted directly to a wall or ceiling
 - 6 types of matching covers
 - possibility of outdoor using (with D cover and waterproof LED strip)
 - maximum LED strip width: 12 mm
-
- montowany bezpośrednio do ściany lub sufitu
 - 6 rodzajów pasujących kloszy
 - możliwość zastosowania zewnętrznego (przy użyciu klosza D i taśmy wodoodpornej)
 - maksymalna szerokość taśmy LED: 12 mm

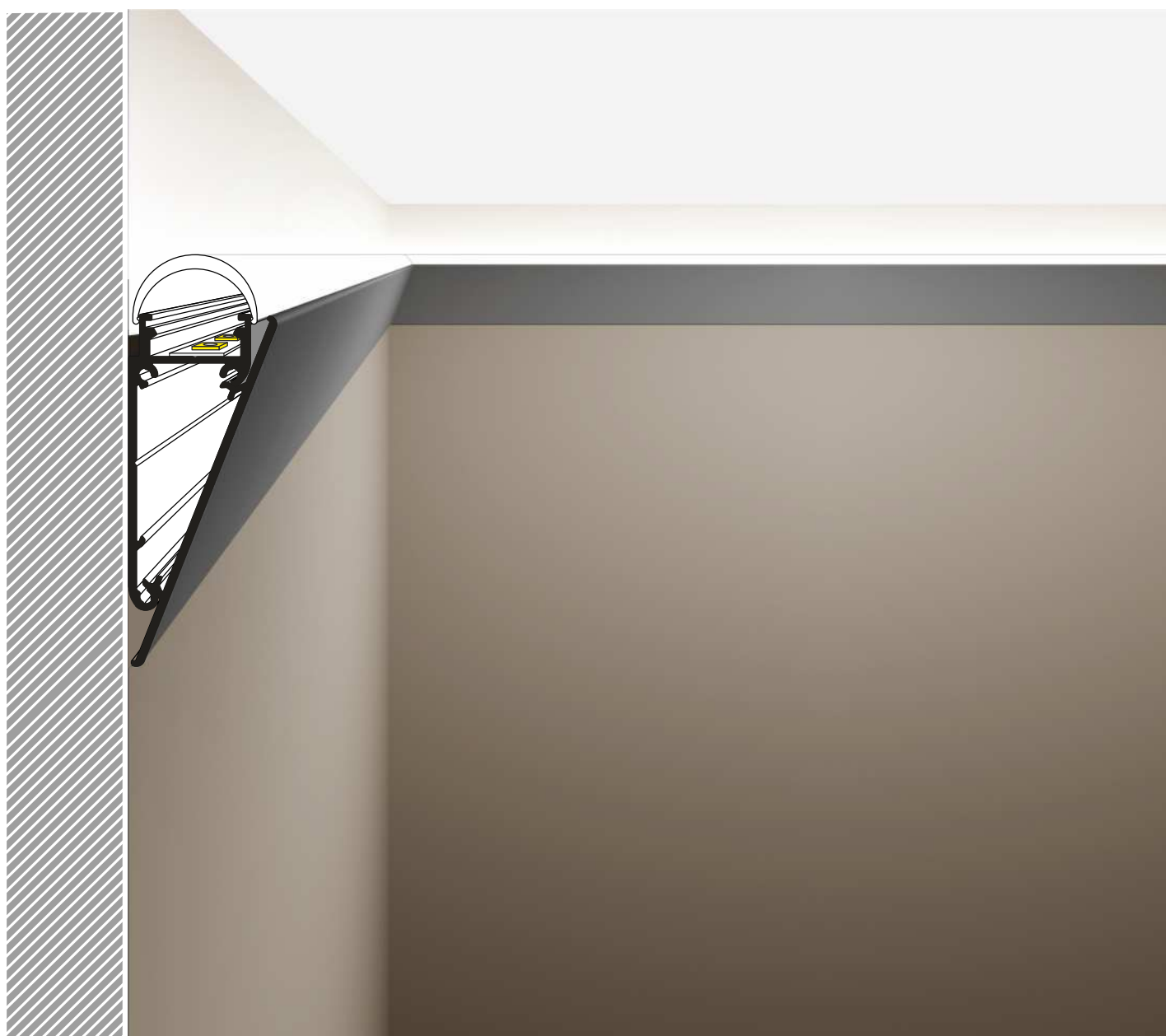

SIMILAR IN THE OFFER / PODOBNE W OFERCIE



WAY10
C



FLAT8
H/UX



BACK10
A/UX



FRAME14
BC/Q



- B** slide cover
klosz B wsuwany
- C** click cover
klosz C klik
- D** click cover
klosz D klik

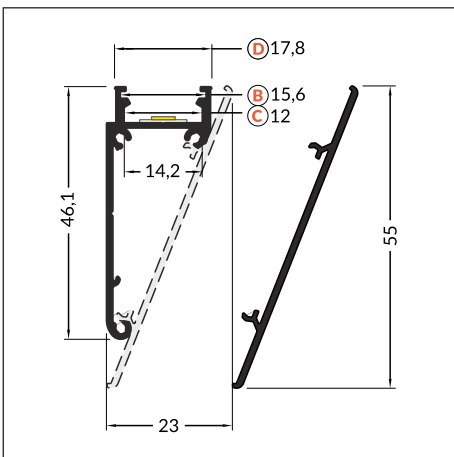
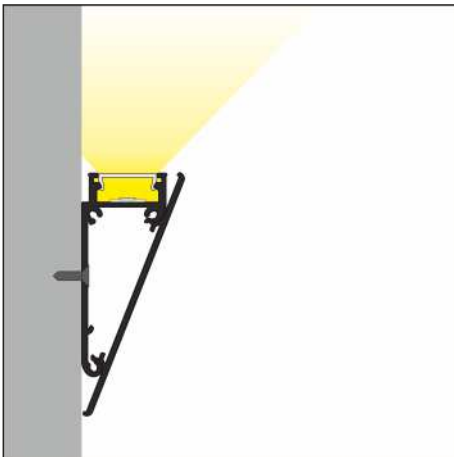
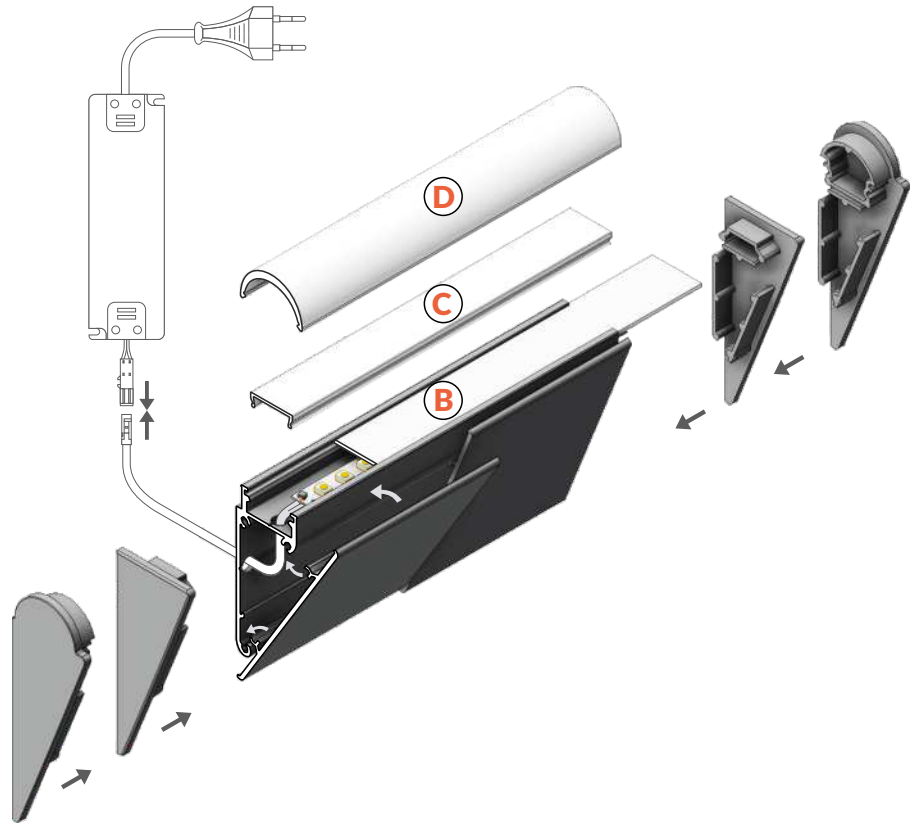

 max 12 mm

 special application
specjalny

INDEX = 1 pc. length 2000 mm
package > check the pricelist
INDEKS = 1 szt., długość 2000 mm
opakowanie > patrz cennik

white painted
biały malowany
B8060001

anodized
anodowany
B8020020

raw aluminium
surowe aluminium
B8020000



Available lengths: 1000 mm, 2000 mm, 3000 mm, 4000 mm.
The standard profile length tolerance is +20 mm.
More details >> 1.08.

Dostępne długości: 1000 mm, 2000 mm, 3000 mm, 4000 mm.
Standardowa tolerancja długości profilu wynosi: +20 mm.
Więcej informacji >> 1.08.



COVERS / KLOSZE

B slide cover
colours: transparent, frosted, opal
material: PC, PP, PP

klosz **B** wsuwany
kolory: transparentny, szron, mleczny
materiał: PC, PP, PP



Note!
Dimensions of the space
to install LED source
Uwaga!
Wymiary przestrzeni
do zamontowania
źródła LED

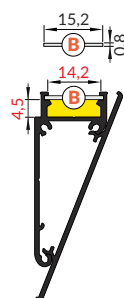

C click cover
colours: transparent, opal
material: PMMA

klosz **C** klik
kolory: transparentny, mleczny
materiał: PMMA

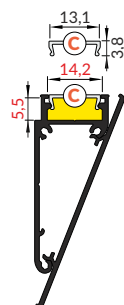

D click cover
colour: opal
material: PMMA

klosz **D** klik
kolor: mleczny
materiał: PMMA

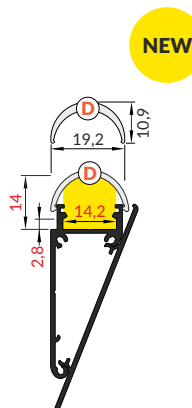

length 2000 mm
package > check the pricelist
długość 2000 mm
opakowanie > patrz cennik

B transparent / B transparentny
index = 10 pcs / indeks = 10 szt.
76250016

B frosted / B szrony
index = 10 pcs / indeks = 10 szt.
76250039

B opal / B mleczny
index = 10 pcs / indeks = 10 szt.
76250038

C transparent / C transparentny
index = 1 pc / indeks = 1 szt.
76330000

C opal / C mleczny
index = 1 pc / indeks = 1 szt.
76330038

reel, length 20 m
package > check the pricelist
rolka, długość 20 m
opakowanie > patrz cennik

C opal / C mleczny
index = 1 pc / indeks = 1 szt.
76360038S

length 2000 mm
package > check the pricelist
długość 2000 mm
opakowanie > patrz cennik

D opal / D mleczny
index = 1 pc / indeks = 1 szt.
A1140038

The standard cover length tolerance is +20 mm.
More details >> 1.08.

Standardowa tolerancja długości kloszy wynosi: +20 mm
Więcej informacji >> 1.08.

ENDINGS / ZAŚLEPKI

WALLE12 ending
colours: white, silver, grey
material: ABS

zaślepka WALLE12
kolory: biały, srebrny, szary
materiał: ABS

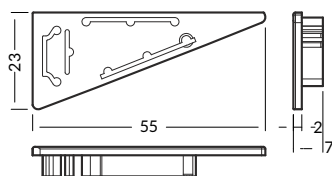

INDEX = 10 sets = 20 pcs
package > check the pricelist
INDEKS = 10 kpl = 20 szt.
opakowanie > patrz cennik

white / biały
B8900001

silver / srebrny
B8900040

grey / szary
B8900022

WALLE12 D ending
colours: white, silver, grey
material: ABS

zaślepka WALLE12 D
kolory: biały, srebrny, szary
materiał: ABS

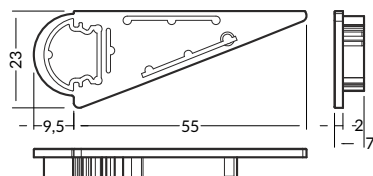

white / biały
B8890001

silver / srebrny
B8890040

grey / szary
B8890022



COVER / OSŁONA

WALLE12 cover
colours: white, anodized
material: aluminium

osłona WALLE12
kolory: biały, anodowany
materiał: aluminium



INDEX = 1 pc, length 2000 mm
package > check the pricelist
INDEKS = 1 szt., długość 2000 mm
opakowanie > patrz cennik

white painted / biały malowany
B808001

anodized / anodowany
B804002

Available lengths: 1000 mm, 2000 mm, 3000 mm, 4000 mm.
The standard profile length tolerance is +20 mm. More details >> 1.08.
Dostępne długości: 1000 mm, 2000 mm, 3000 mm, 4000 mm.
Standardowa tolerancja długości profili wynosi: +20 mm. Więcej informacji >> 1.08.

CONNECTORS / ŁĄCZNIKI

WALLE12 connector 180 deg
colour: inox
material: stainless steel

łącznik WALLE12 180 st
kolor: inox
materiał: stal nierdzewna

WALLE12 connector 90 deg
colours: white, anodized
material: aluminium

łącznik WALLE12 90 st
kolory: biały, anodowany
materiał: aluminium

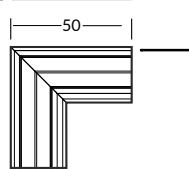
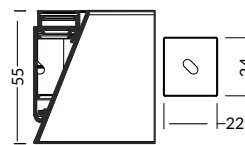
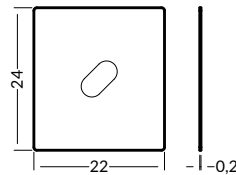

INDEX = 1 set
package > check the pricelist
INDEKS = 1 kpl
opakowanie > patrz cennik

inox
B8950019

white painted / biały malowany
B8910001

anodized / anodowany
B8910020



PEN12 CJ

ROTATABLE DISPLAY LIGHTING SYSTEM

OBROTOWY SYSTEM OŚWIETLENIA EKSPOZYCYJNEGO

- wall and furniture application
- various types of mounting brackets
- maximum LED strip width: 12 mm

- ścienny i meblowy
- różne typy mocowań
- maksymalna szerokość taśmy LED: 12 mm



SIMILAR IN THE OFFER / PODOBNE W OFERCIE



PEN8
I



CABI12
E



CORNER10
BC/UX



TRIO10
BC



OVAL20
BC



- J** slide cover
klosz J wsuwany
- C** click cover
klosz C klik
- C** lens cover
klosz C soczewka

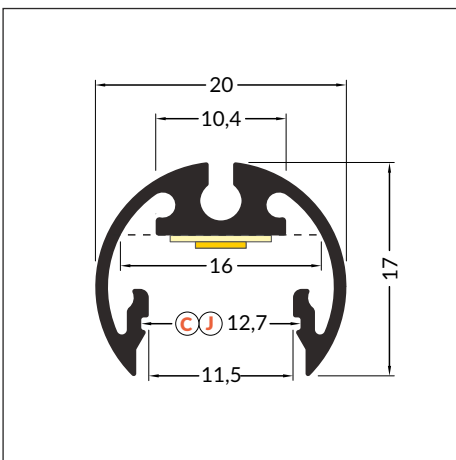
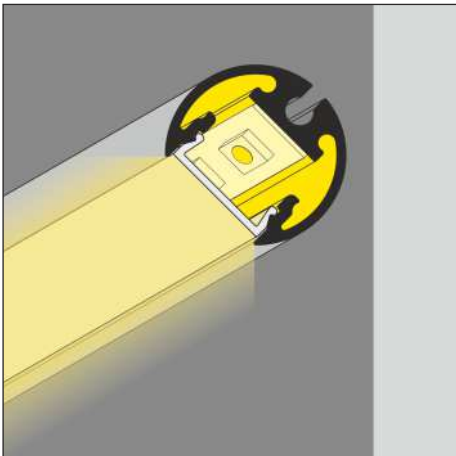
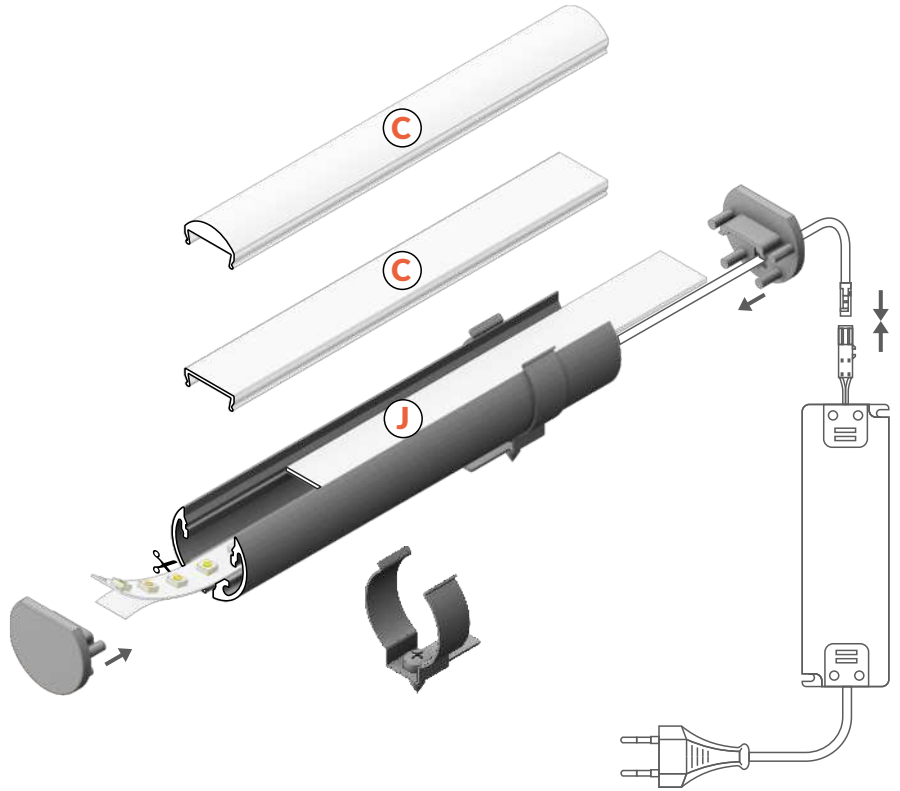

max 12 mm



special application
specjalny



INDEX = 1 pc, length 2000 mm
package > check the pricelist
INDEKS = 1 szt., długość 2000 mm
opakowanie > patrz cennik

white painted
biały malowany
F7000201



anodized
anodowany
F7000220



black painted
czarny malowany
F7000202

Available lengths: 1000 mm, 2000 mm, 3000 mm, 4000 mm.
The standard profile length tolerance is +20 mm.
More details >> 1.08.

Dostępne długości: 1000 mm, 2000 mm, 3000 mm, 4000 mm.
Standardowa tolerancja długości profili wynosi: +20 mm.
Więcej informacji >> 1.08.



COVERS / KLOSZE

J slide cover

colours: transparent, frosted, opal
material: PC, PP, PP

klosz J wsuwany
kolory: transparentny, szron, mleczny
materiał: PC, PP, PP



Note! Dimensions of the space to install LED source
Uwaga! Wymiary przestrzeni do zamontowania źródła LED

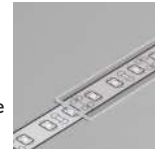
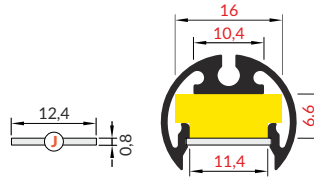

length 2000 mm
package > check the pricelist
długość 2000 mm
opakowanie > patrz cennik

J transparent / J transparentny

index = 10 pcs / indeks = 10 szt.

70330016



J frosted / J szron

index = 10 pcs / indeks = 10 szt.

70330039



J opal / J mleczny

index = 10 pcs / indeks = 10 szt.

70330038



C transparent / C transparentny

index = 1 pc / indeks = 1 szt.

76330000



C opal / C mleczny

index = 1 pc / indeks = 1 szt.

76330038

C click cover

colours: transparent, opal
material: PMMA

klosz C klik
kolory: transparentny, mleczny
materiał: PMMA

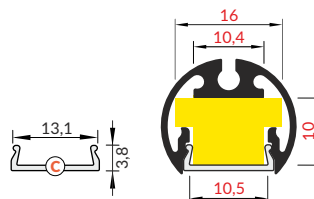

reel, length 20 m
package > check the pricelist
rolka, długość 20 m
opakowanie > patrz cennik

C opal / C mleczny

index = 1 pc / indeks = 1 szt.

76360038S



length 2000 mm
package > check the pricelist
długość 2000 mm
opakowanie > patrz cennik

C lens / C soczewka

index = 1 pc / indeks = 1 szt.

76300000

C lens click cover

colour: transparent
material: PC

klosz C klik soczewka
kolor: transparentny
materiał: PC

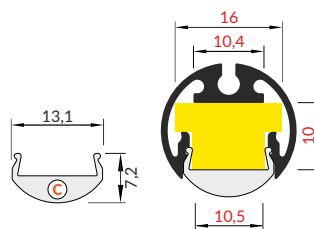

The standard cover length tolerance is +20 mm.
More details >> 1.08.

Standardowa tolerancja długości kloszy wynosi: +20 mm
Więcej informacji >> 1.08.

ENDINGS / ZAŚLEPKI

PEN12 ending

colours: white, silver, black, grey
material: ABS

zaślepka PEN12
kolory: biały, srebrny, czarny, szary
materiał: ABS



Ending with marked space to bore the holes.
Zaślepka z punktami do przewiercenia otworów.

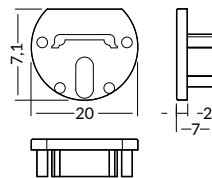

INDEX = 10 sets = 20 pcs
package > check the pricelist
INDEKS = 10 kpl = 20 szt.
opakowanie > patrz cennik

white / biały

F7009901

silver / srebrny

F7009940

black / czarny

F7009902

grey / szary

F7009922

MOUNTINGS / MOCOWANIA

PEN12 flat holder

colour: inox
material: stainless steel

uchwyt PEN12 płaski
kolor: inox
materiał: stal nierdzewna

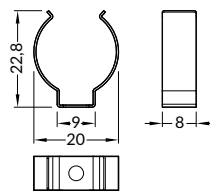
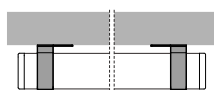

Horizontal mounting,
possible after bending
one of the handles.
Montaż poziomy
możliwy po dogięciu
jednego z uchwytów.

INDEX = 10 sets = 20 pcs
package > check the pricelist
INDEKS = 10 kpl = 20 szt.
opakowanie > patrz cennik

inox

F7009019



MOUNTINGS / MOCOWANIA

PEN12 stretcher holder
colour: chrome
material: brass

uchwyt PEN12 rozporowy
kolor: chrom
materiał: mosiądz

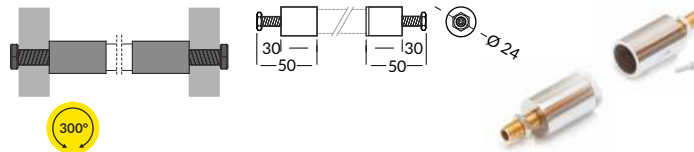

INDEX = 1 set = 2 pcs
package > check the pricelist
INDEKS = 1 kpl = 2 szt.
opakowanie > patrz cennik

chrome / chrom
F7009103

PEN12 ring holder
colours: chrome
material: brass

uchwyt PEN12 ring
kolory: chrom
materiał: mosiądz

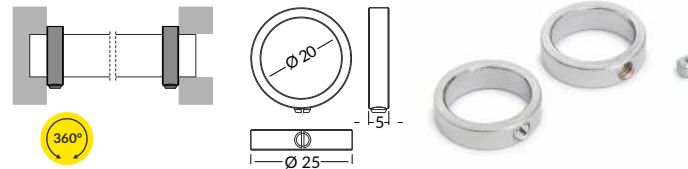

chrome / chrom
F7009203

PEN12 double holder with thread
colour: chrome
material: steel, brass

uchwyt PEN12 podwójny z gwintem
kolor: chrom
materiał: stal, mosiądz

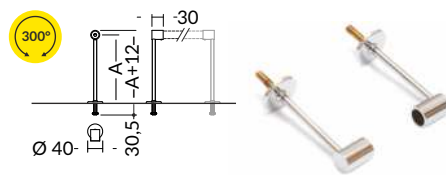

A =

100 mm	F7009303
200 mm	F7009403
300 mm	F7009503

PEN12 double holder with soffit ceiling
colour: chrome
material: steel, brass

uchwyt PEN12 podwójny z podsufitką
kolor: chrom
materiał: stal, mosiądz

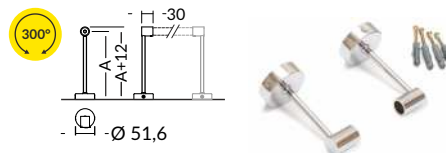

A =

100 mm	F7009603
200 mm	F7009703
300 mm	F7009803

PEN12 wall-mounted extension arm
colours: white, silver, black
material: steel, brass

uchwyt PEN12 wysięgnik ścienny
kolory: biały, srebrny, czarny
materiał: stal, mosiądz

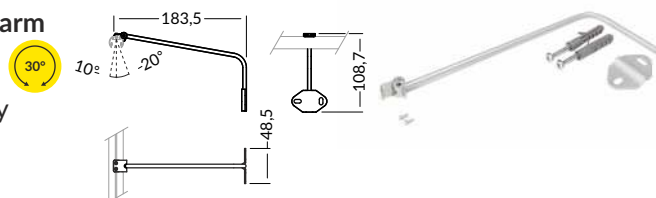

INDEX = 1 set = 1 pc
package > check the pricelist
INDEKS = 1 kpl = 1 szt.
opakowanie > patrz cennik

white / biały
F7008801
silver / srebrny
F7008822
black / czarny
F7008802

PEN12 cabinet-mounted extension arm
colours: white, silver, black
material: steel, brass

uchwyt PEN12 wysięgnik nadszafkowy
kolory: biały, srebrny, czarny
materiał: stal, mosiądz

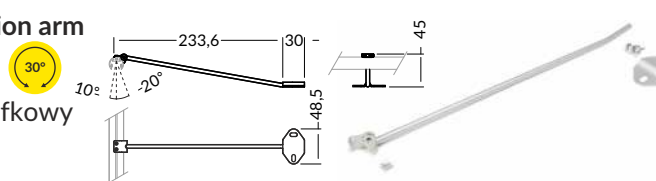

white / biały
F7008901
silver / srebrny
F7008922
black / czarny
F7008902



FAMILY OF PROFILES FOR UNDER-TILE MOUNTING

RODZINA PROFILI DO MONTAŻU PODPŁYTKOWEGO

- three mounting angles available: 90, 180, 270 degrees
 - for 10 mm tiles
 - version with perforated mounting holes available
 - maximum LED strip width: 12 mm
-
- dostępne trzy kąty montażu: 90 / 180 / 270 st
 - do płytek o grubości do 10 mm
 - dostępna wersja z gotowym otworowaniem montażowym
 - maksymalna szerokość taśmy LED: 12 mm



SIMILAR IN THE OFFER / PODOBNE W OFERCIE



FRAME14
BC/Q



UNI12
BCD/U



FLOOR12
K/U



OUTSTAIRS12
BC

UNI-TILE12 90 deg/st C



C click cover
klosz C klik

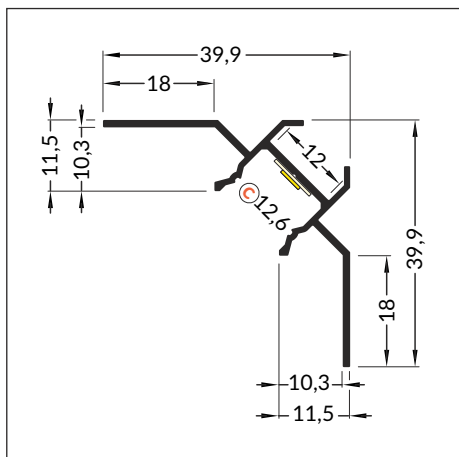
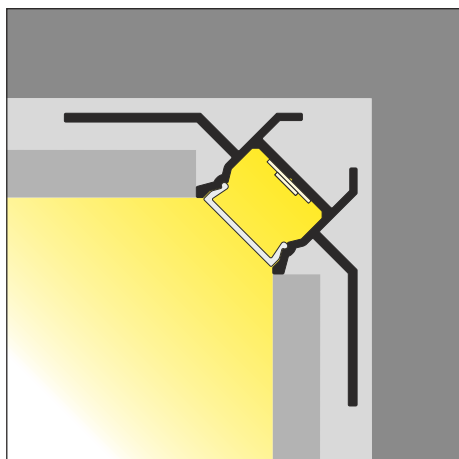
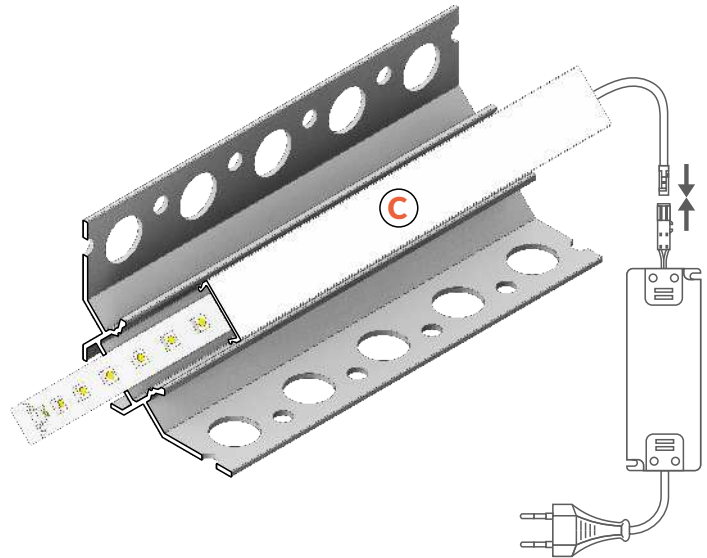

INDEX = 1 pc, length 2000 mm package > check the pricelist
INDEKS = 1 szt., długość 2000 mm opakowanie > patrz cennik

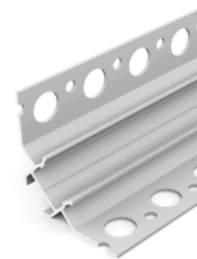

90 deg PLUS
anodized
anodowany
G4000620

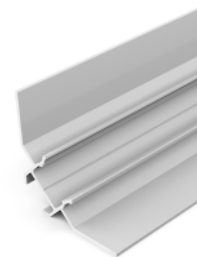

90 deg
anodized
anodowany
G4000220



max 12 mm



special application
specjalny

PLUS version available lengths: 1000 mm, 2000 mm, 2500 mm, 3000 mm, 4000 mm.
Standard version available lengths: 1000 mm, 2000 mm, 3000 mm, 4000 mm.
The standard profile length tolerance is +20 mm. More details >> 1.08.

Dostępne długości wersji PLUS: 1000 mm, 2000 mm, 2500 mm, 3000 mm, 4000 mm.
Dostępne długości wersji standardowej: 1000 mm, 2000 mm, 3000 mm, 4000 mm.
Standardowa tolerancja długości profili wynosi: +20 mm. Więcej informacji >> 1.08.

UNI-TILE12 180 deg/st C



C click cover
klosz C klik

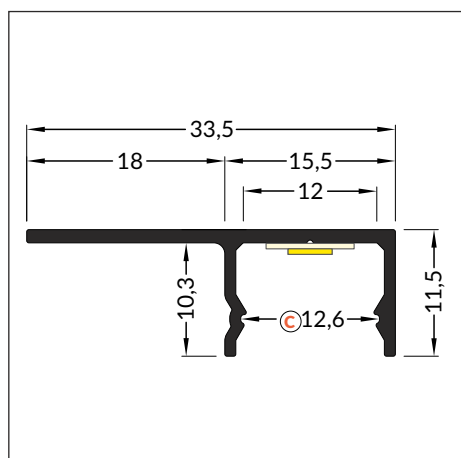
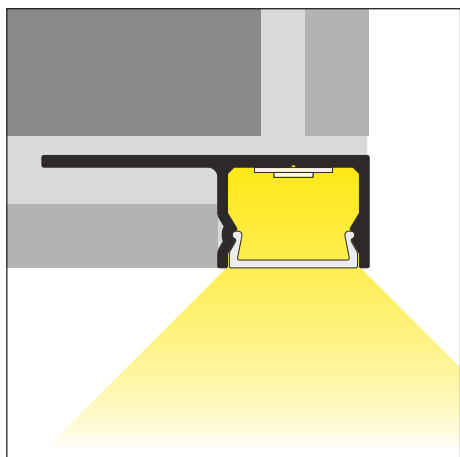
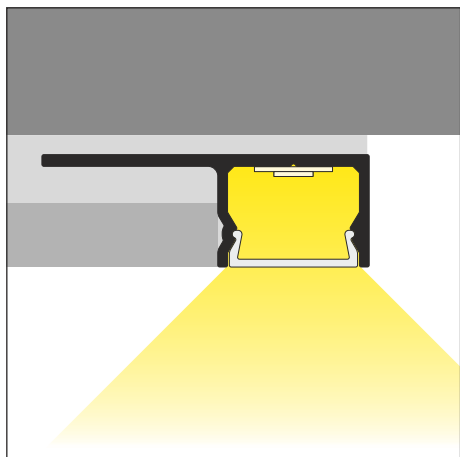

max 12 mm

special application
specjalny

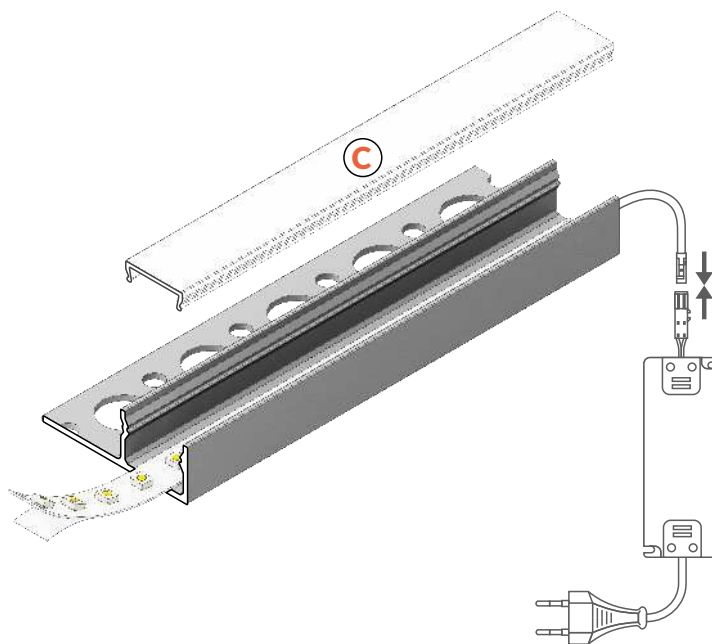

INDEX = 1 pc, length 2000 mm package > check the pricelist
INDEKS = 1 szt., długość 2000 mm opakowanie > patrz cennik

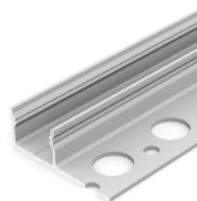

180 deg PLUS
anodized
anodowany
G2000620

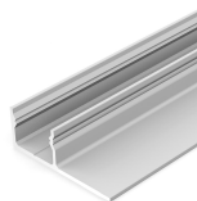

180 deg
anodized
anodowany
G2000220

PLUS version available lengths: 1000 mm, 2000 mm, 2500 mm, 3000 mm, 4000 mm.
Standard version available lengths: 1000 mm, 2000 mm, 3000 mm, 4000 mm.
The standard profile length tolerance is +20 mm. More details >> 1.08.

Dostępne długości wersji PLUS: 1000 mm, 2000 mm, 2500 mm, 3000 mm, 4000 mm.
Dostępne długości wersji standardowej: 1000 mm, 2000 mm, 3000 mm, 4000 mm.
Standardowa tolerancja długości profili wynosi: +20 mm. Więcej informacji >> 1.08.

UNI-TILE12 270 deg/st C



C click cover
klosz C klik

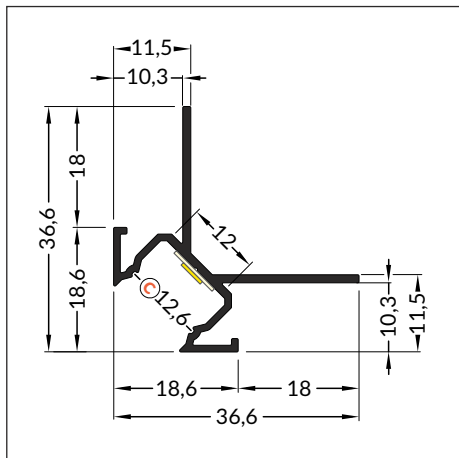
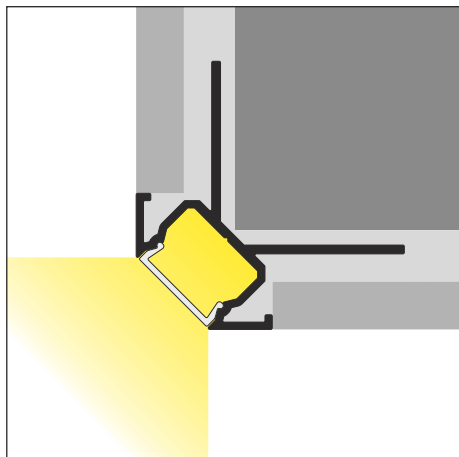
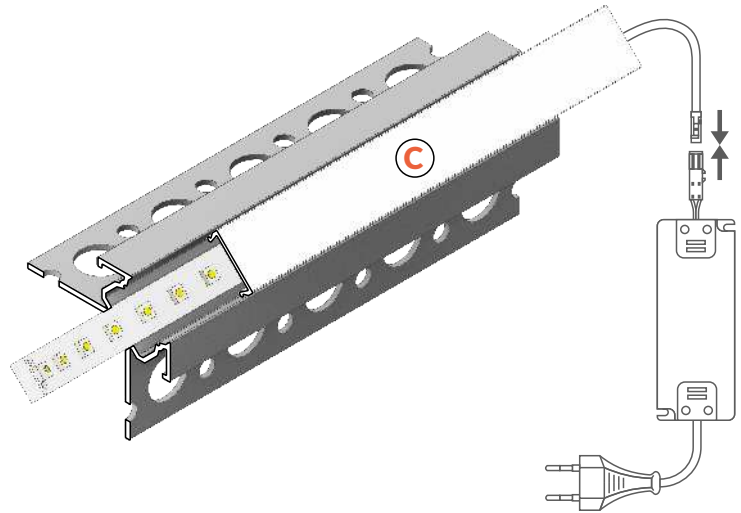

INDEX = 1 pc, length 2000 mm package > check the pricelist
INDEKS = 1 szt., długość 2000 mm opakowanie > patrz cennik

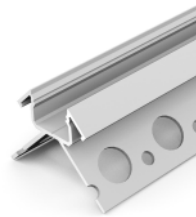

270 deg PLUS
anodized
anodowany
G3000620

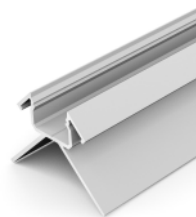

270 deg
anodized
anodowany
G3000220



max 12 mm



special application
specjalny

PLUS version available lengths: 1000 mm, 2000 mm, 2500 mm, 3000 mm, 4000 mm.
Standard version available lengths: 1000 mm, 2000 mm, 3000 mm, 4000 mm.
The standard profile length tolerance is +20 mm. More details >> 1.08.

Dostępne długości wersji PLUS: 1000 mm, 2000 mm, 2500 mm, 3000 mm, 4000 mm.
Dostępne długości wersji standardowej: 1000 mm, 2000 mm, 3000 mm, 4000 mm.
Standardowa tolerancja długości profili wynosi: +20 mm. Więcej informacji >> 1.08.



COVERS / KLOSZE

C click cover
colours: transparent, opal
material: PMMA

klosz **C** klik
kolory: transparentny, mleczny
materiał: PMMA



Note! Dimensions of the space
to install LED source
Uwaga! Wymiary przestrzeni
do zamontowania źródła LED

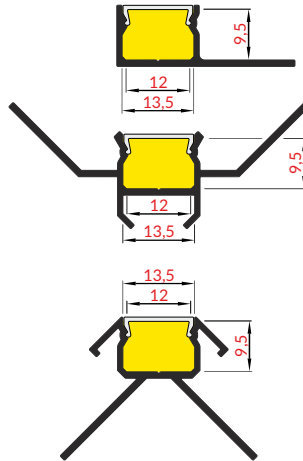
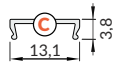

NEW

length 2000 mm
package > check the pricelist
długość 2000 mm
opakowanie > patrz cennik

C transparent / C transparentny
index = 1 pc / indeks = 1 szt.
76330000

C opal / C mleczny
index = 1 pc / indeks = 1 szt.
76330038

reel, length 20 m
package > check the pricelist
rolka, długość 20 m
opakowanie > patrz cennik

C opal / C mleczny
index = 1 pc / indeks = 1 szt.
76360038S

The standard cover length tolerance is +20 mm.
More details >> 1.08.

Standardowa tolerancja długości kloszki wynosi: +20 mm
Więcej informacji >> 1.08.





FRAME14 BC/Q

ALUMINIUM LED PROFILE FOR PLASTERBOARD

ALUMINIOWY PROFIL LED DO PŁYT KARTONOWO-GIPSOWYCH

- dedicated for plasterboards - decorative construction finish
 - continuous line of light (when using LED strip 120 P/m and opal cover)
 - multiple arrangements through a variety of connectors
 - maximum LED strip width: 14 mm
-
- dedykowany do płyt kartonowo-gipsowych - dekoracyjne wykończenie konstrukcji
 - ciągła linia światła (przy zastosowaniu taśmy 120 P/m i klosza mlecznego)
 - wiele możliwości aranżacyjnych dzięki różnorodnym łącznikom
 - maksymalna szerokość taśmy LED: 14 mm



SIMILAR IN THE OFFER / PODOBNE W OFERCIE



FLAT8
H/UX



DEEP10
BC/UX



WALLE12
CD



UNI-TILE12
90 deg C



UNI-TILE12
180 deg C



UNI-TILE12
270 deg C



B slide cover
klosz B wsuwany

C click cover
klosz C klik

Q¹ 90 deg bent connector
łącznik Q 90 st gięty

Q² connector 180 deg
łącznik Q 180 st

Q³ connector 135 deg
łącznik Q 135 st

Q⁴ connector 90 deg
łącznik Q 90 st

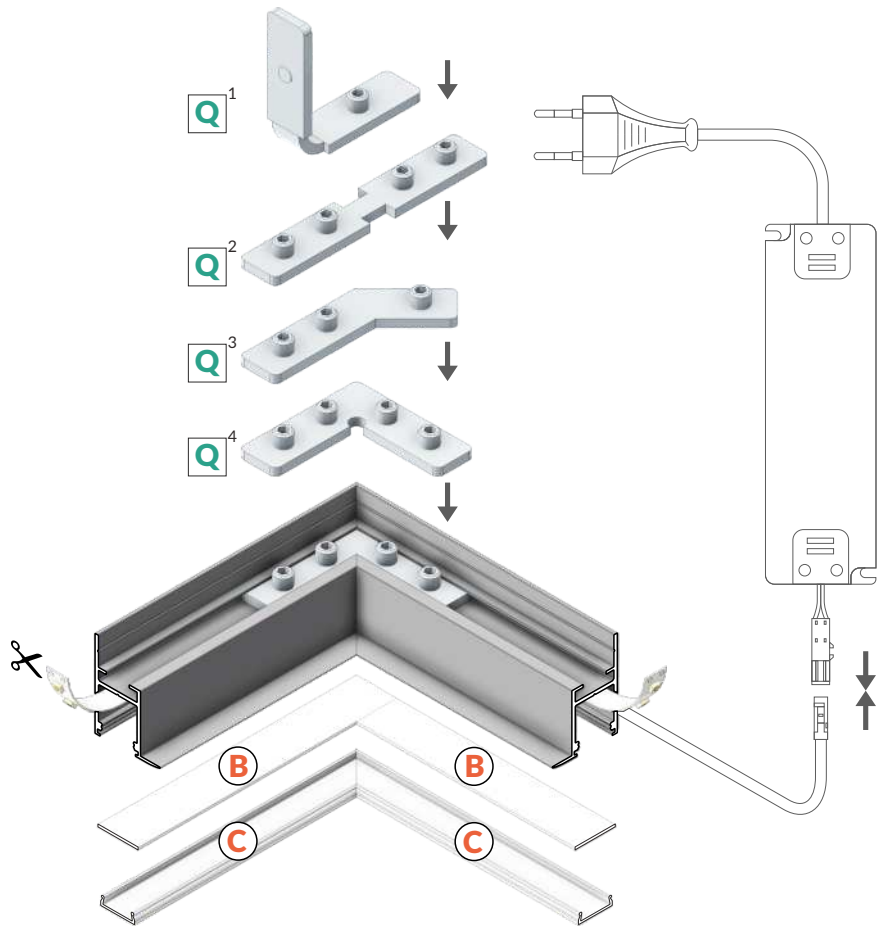
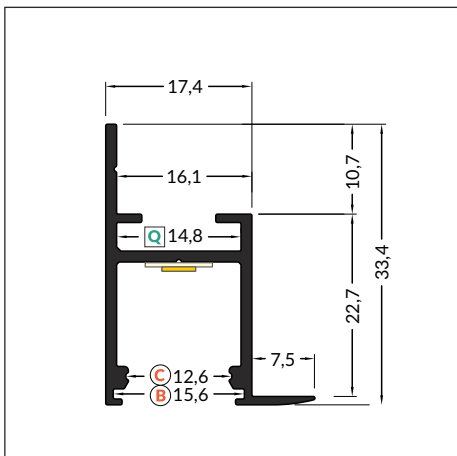
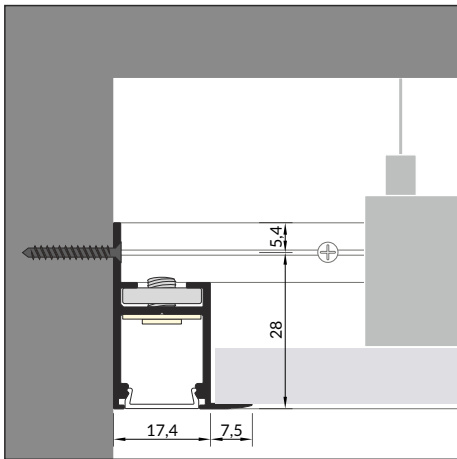
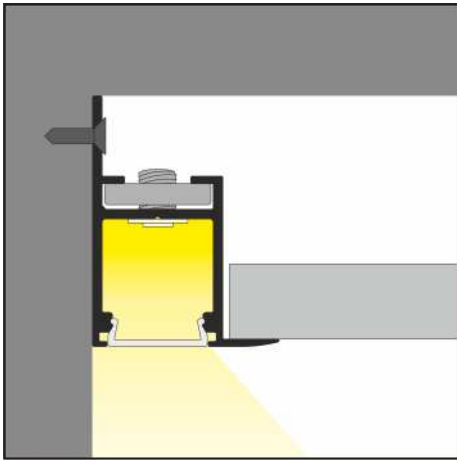

INDEX = 1 pc, length 2000 mm
package > check the pricelist
INDEKS = 1 szt., długość 2000 mm
opakowanie > patrz cennik

white painted
biały malowany
C3020001

anodized
anodowany
C3020020

raw aluminium
surowe aluminium
C3020000

Please note! The profile
isn't a construction profile.
Uwaga. Profil nie pełni
funkcji konstrukcyjnej.



max 14 mm



special application
specjalny



Available lengths: 1000 mm, 2000 mm, 3000 mm, 4000 mm.
The standard profile length tolerance is +20 mm.
More details >> 1.08.

Dostępne długości: 1000 mm, 2000 mm, 3000 mm, 4000 mm.
Standardowa tolerancja długości profili wynosi: +20 mm.
Więcej informacji >> 1.08.



COVERS / KLOSZE

B slide cover

colours: transparent, frosted, opal
material: PC, PP, PP

klosz B wsuwany
kolory: transparentny, szron, mleczny
materiał: PC, PP, PP



Note!
Dimensions of the space
to install LED source
Uwaga!
Wymiary przestrzeni
do zamontowania
źródła LED

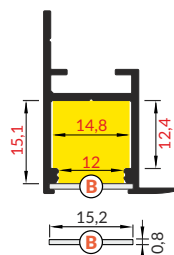

C click cover

colours: transparent, opal
material: PMMA

klosz C klik
kolory: transparentny, mleczny
materiał: PMMA

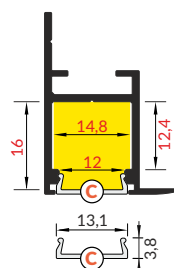

NEW

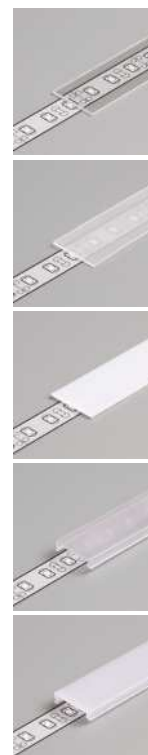

length 2000 mm
package > check the pricelist
długość 2000 mm
opakowanie > patrz cennik

B transparent / B transparentny
index = 10 pcs / indeks = 10 szt.
76250016

B frosted / B szron
index = 10 pcs / indeks = 10 szt.
76250039

B opal / B mleczny
index = 10 pcs / indeks = 10 szt.
76250038

C transparent / C transparentny
index = 1 pc / indeks = 1 szt.
76330000

C opal / C mleczny
index = 1 pc / indeks = 1 szt.
76330038

reel, length 20 m
package > check the pricelist
rolka, długość 20 m
opakowanie > patrz cennik

C opal / C mleczny
index = 1 pc / indeks = 1 szt.
76360038S

The standard cover length tolerance is +20 mm.
More details >> 1.08.

Standardowa tolerancja długości kloszy wynosi: +20 mm
Więcej informacji >> 1.08.

CONNECTORS / ŁĄCZNIKI

Q 180 deg / 135 deg / 90 deg connector

material: zinc coated
łącznik Q 180 st / 135 st / 90 st
materiał: stal ocynkowana

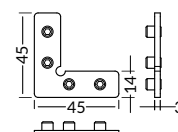
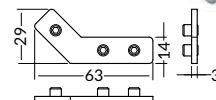
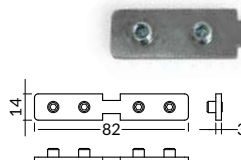

Q 90 deg bent connector

material: zinc coated
łącznik Q 90 st gięty
materiał: stal ocynkowana

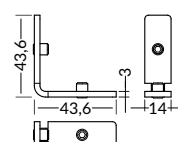

INDEX = 1 set
package > check the pricelist
INDEKS = 1 kpl
opakowanie > patrz cennik

Q 180 deg connector
łącznik Q 180 st
C3990030

Q 135 deg connector
łącznik Q 135 st
C3980030

Q 90 deg connector
łącznik Q 90 st
C3970030

Q 90 deg bent connector
łącznik Q 90 st gięty
C3960030



OVAL20 BC

A DOUBLE-FUNCTION BAR FOR WARDROBES

DWUFUNKCYJNY DRAŻEK DO SZAF GARDEROBIANYCH

- a bar for hanging garments and illuminating the wardrobe
 - 3 mounting options: side-to-side, as an extension arm from a side, as an extension arm from the top
 - two LED strip installation depths to choose from
 - maximum LED strip width: 20 mm
-
- drążek do wieszania ubrań i oświetlania szafy
 - 3 opcje montażu: od ścianki do ścianki, jako wysięgnik ze ściany, jako wysięgnik z sufitu
 - do wyboru dwie głębokości osadzenia taśmy LED
 - maksymalna szerokość taśmy LED: 20 mm

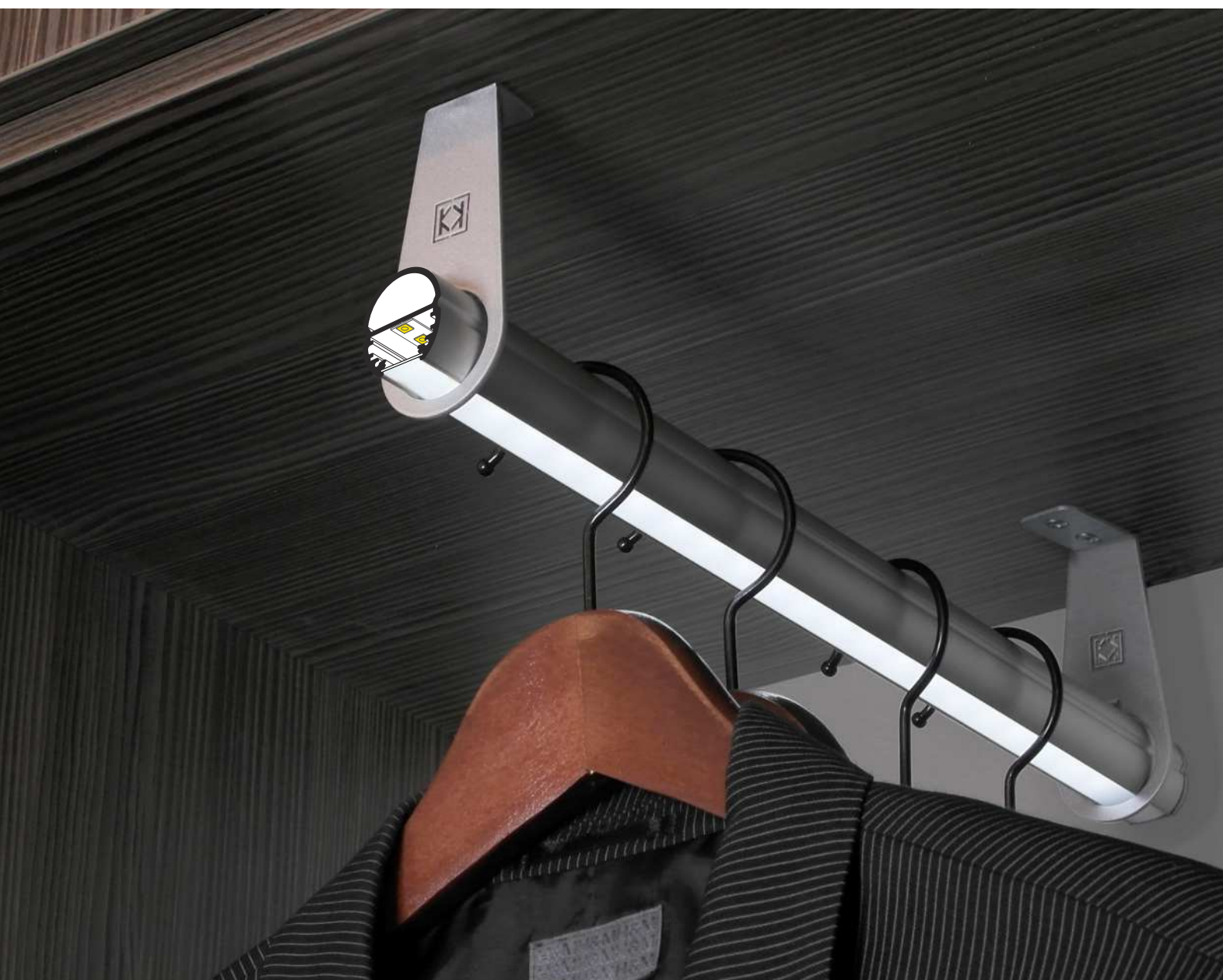

SIMILAR IN THE OFFER / PODOBNE W OFERCIE



PEN8



PEN12



B B slide cover
klosz B wsuwany

C C click cover
klosz C klik

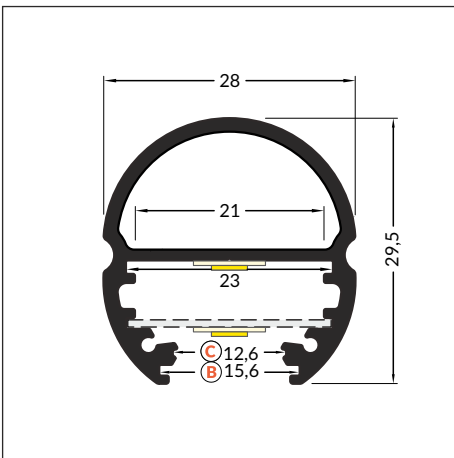
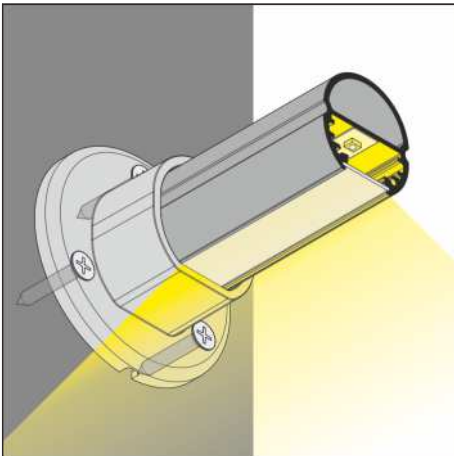
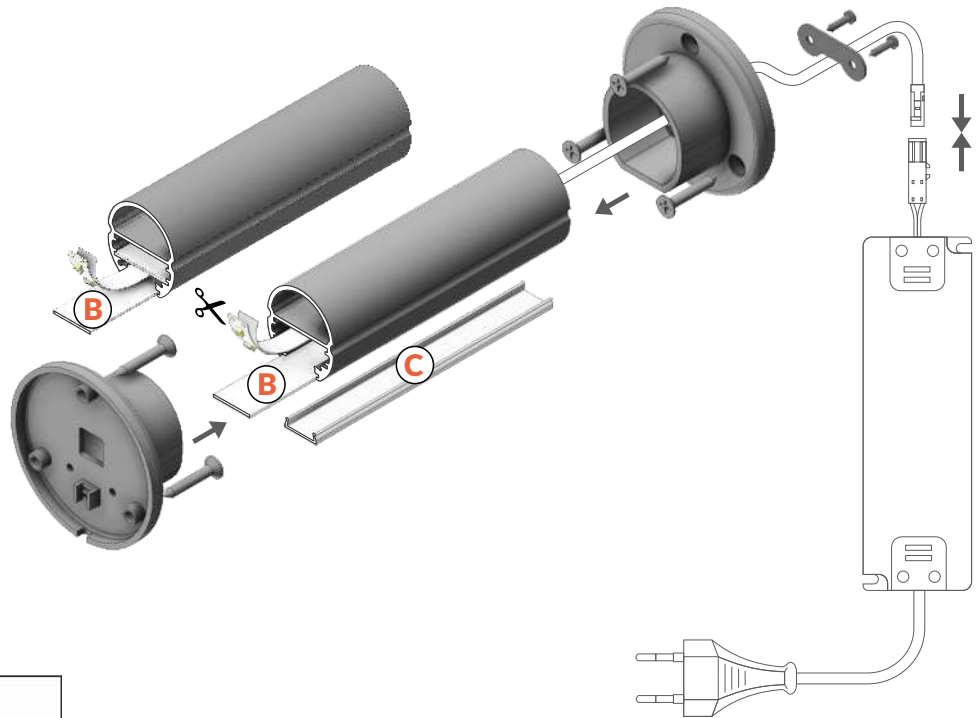

 max 20 mm

 special application
specjalny

INDEX = 1 pc, length 2000 mm
package > check the pricelist
INDEKS = 1 szt., długość 2000 mm
opakowanie > patrz cennik

anodized
anodowany
92030020



Available lengths: 1000 mm, 2000 mm, 3000 mm, 4000 mm.
The standard profile length tolerance is +20 mm.
More details >> 1.08.

Dostępne długości: 1000 mm, 2000 mm, 3000 mm, 4000 mm.
Standardowa tolerancja długości profili wynosi: +20 mm.
Więcej informacji >> 1.08.



COVERS / KLOSZE

B slide cover

colours: transparent, frosted, opal
material: PC, PP, PP

klosz B wsuwany
kolory: transparentny, szron, mleczny
materiał: PC, PP, PP



Note! Dimensions of the space to install LED source
Uwaga! Wymiary przestrzeni do zamontowania źródła LED

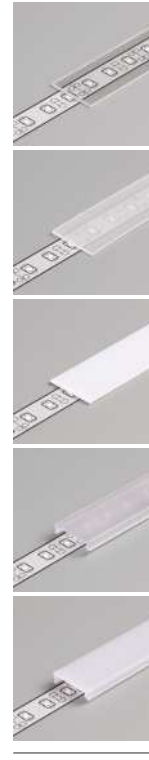
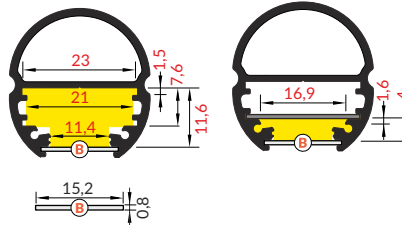

length 2000 mm
package > check the pricelist
długość 2000 mm
opakowanie > patrz cennik

B transparent / B transparentny
index = 10 pcs / indeks = 10 szt.
76250016

B frosted / B szron
index = 10 pcs / indeks = 10 szt.
76250039

B opal / B mleczny
index = 10 pcs / indeks = 10 szt.
76250038

C click cover

colours: transparent, opal
material: PMMA

klosz C klik
kolory: transparentny, mleczny
materiał: PMMA

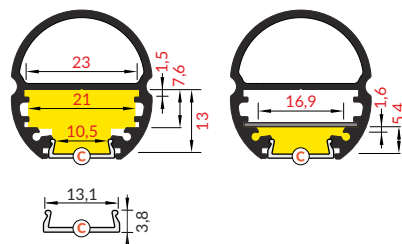

NEW



reel, length 20 m
package > check the pricelist
rolka, długość 20 m
opakowanie > patrz cennik

C opal / C mleczny
index = 1 pc / indeks = 1 szt.
76330038

The standard cover length tolerance is +20 mm.
More details >> 1.08.
Standardowa tolerancja długości kloszy wynosi: +20 mm
Więcej informacji >> 1.08.

MOUNTINGS / MOCOWANIA

OVAL20 side holder

colours: silver, grey
material: ABS

uchwyt OVAL20 boczny
kolory: srebrny, szary
materiał: ABS

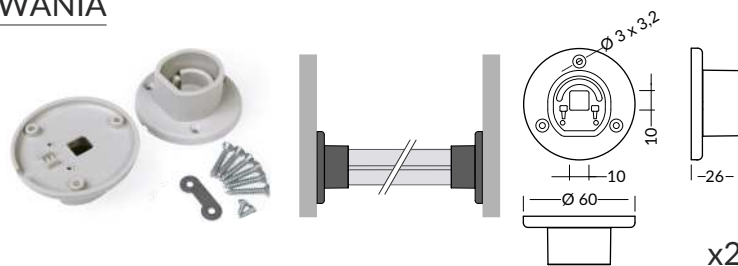

INDEX = 1 set
package > check the pricelist
INDEKS = 1 kpl
opakowanie > patrz cennik

silver / srebrny
92040040
grey / szary
92040022

OVAL20 single extension arm

colour: silver
material: ABS, steel, aluminium

wysięgnik OVAL20 pojedynczy
kolor: srebrny
materiał: ABS, stal, aluminium

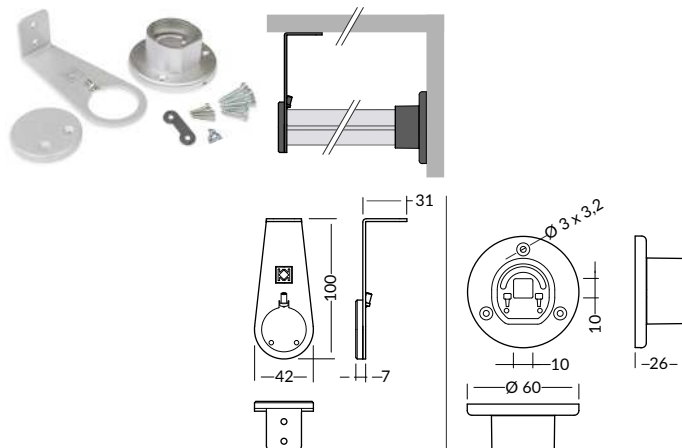

silver / srebrny
92980040



MOUNTINGS / MOCOWANIA

OVAL20 double extension arm
colour: silver
material: ABS, steel, aluminium
wysięgnik OVAL20 podwójny
kolor: srebrny
materiał: ABS, stal, aluminium

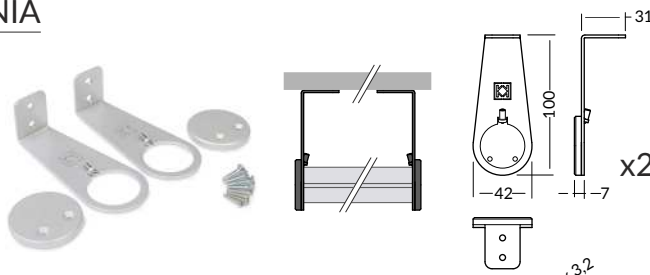

INDEX = 1 set
package > check the pricelist
INDEKS = 1 kpl
opakowanie > patrz cennik

silver / srebrny
92990040

OVAL20 simple holder
material: zinc coated steel
uchwyt OVAL20 prosty
materiał: stal ocynkowana



zinc coated
stal ocynkowana
92070030

LED MOUNTING / MOCOWANIE LED

OVAL20 LED mounting
material: aluminium
mocowanie LED OVAL20
materiał: aluminium

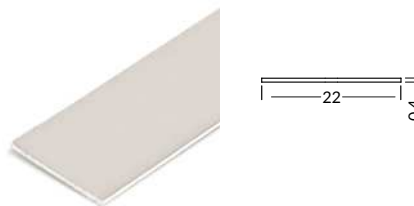

INDEX = 1 pc, length 2000 mm
package > check the pricelist
INDEKS = 1 szt., długość 2000 mm
opakowanie > patrz cennik

raw aluminium
surowe aluminium
92100000





2020 LED PROFILES PROFILE LED

GLASS APPLICATION / DO SZKŁA



TWIN8

A TWO-WAY EDGE PROFILE FOR GLASS SHELVES

DWUKIERUNKOWY PROFIL KRAWĘDZIOWY DO SZKLANYCH PÓŁEK

- decorative illumination
 - mounted on the glass or shelf rear edge
 - 2 lighting directions: up and down
 - illuminating the rear side of a display case
 - additionally illumination of the glass edge with the TWIN8 PLUS profile
 - fits the 8 mm thick glass panel
 - when using on a thinner glass, consider additional adhesive tape
 - note: the profile is not a construction element
 - maximum LED strip width: 8 mm
-
- oświetlenie dekoracyjne
 - montaż do tylnej krawędzi szyby, półki
 - 2 kierunki świecenia: góra i dół
 - oświetla wewnętrzną ścianę witryny
 - dodatkowo podświetlenie krawędzi szyby w wersji TWIN8 PLUS
 - do szyby o grubości 8 mm
 - możliwość zastosowania do cieńszej szyby - należy przewidzieć dodatkowe klejenie taśmą
 - uwaga: profil nie jest elementem konstrukcyjnym
 - maksymalna szerokość taśmy LED: 8 mm

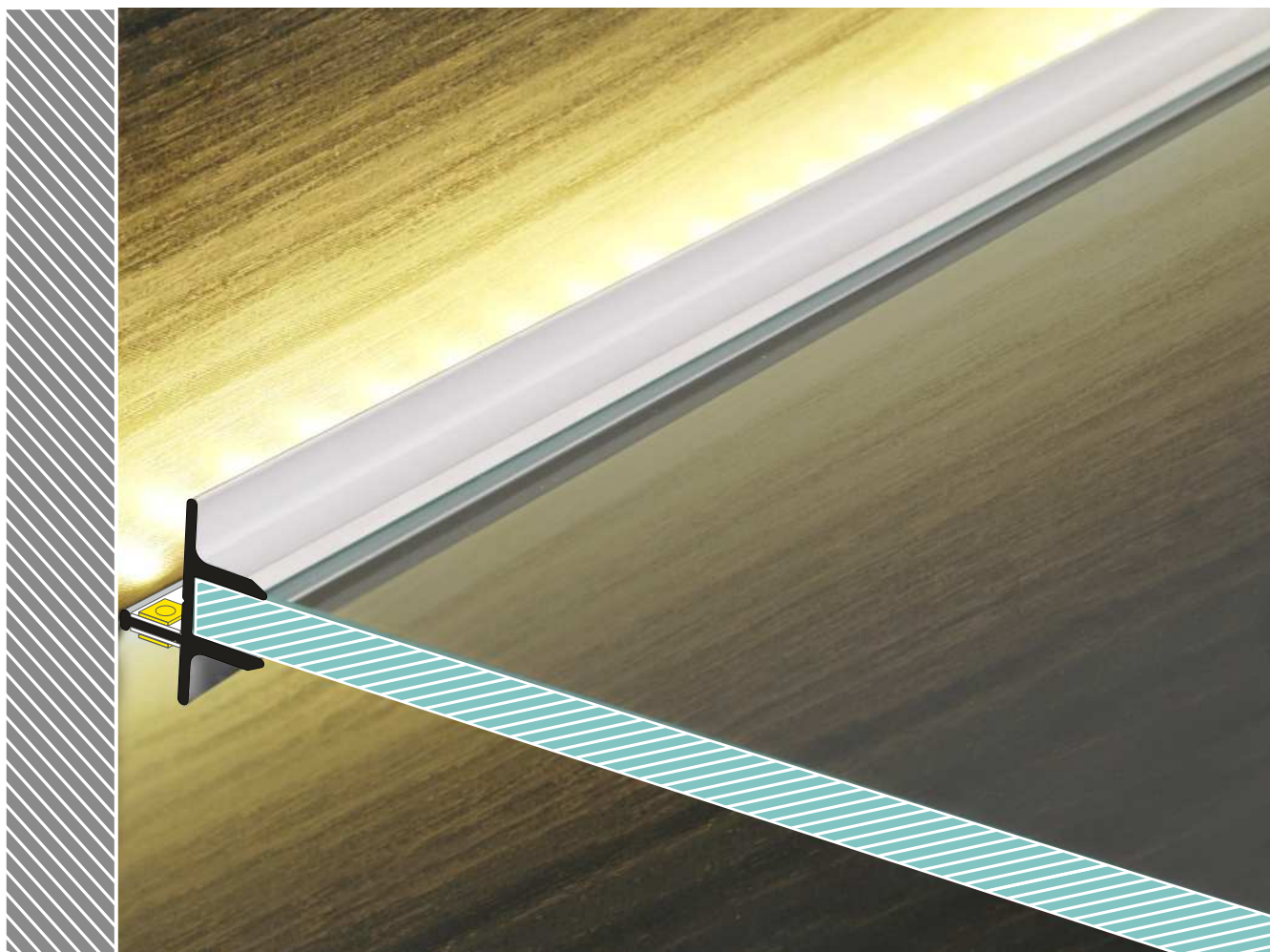

SIMILAR IN THE OFFER / PODOBNE W OFERCIE

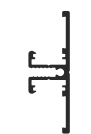

BACK10
A/UX



EDGE10
BC



MIKRO10



MIKRO-LINE12



CABI12
E

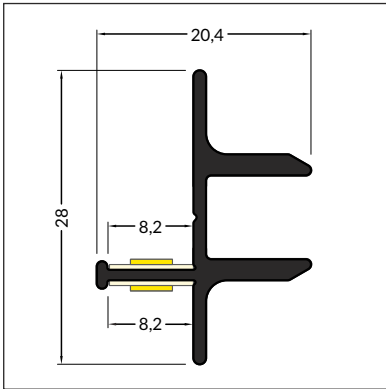

max 8 mm



glass application
do szkła

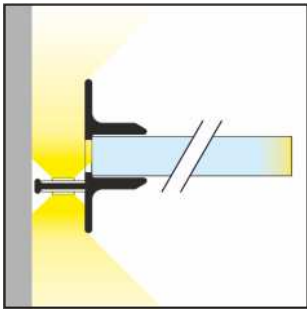
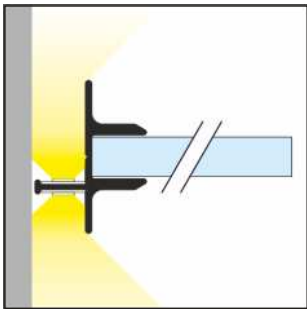
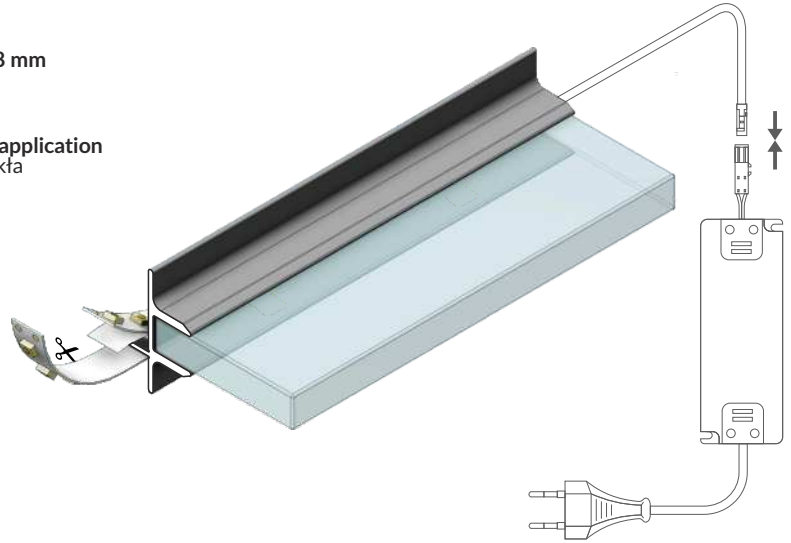

INDEX = 1 pc, length 2000 mm
package > check the pricelist
INDEKS = 1 szt., długość 2000 mm
opakowanie > patrz cennik

TWIN8
raw aluminium
surowe aluminium
82150000

TWIN8 PLUS
raw aluminium
surowe aluminium
82160000

Available lengths: 1000 mm, 2000 mm,
3000 mm, 4000 mm. The standard profile
length tolerance is +20 mm.
More details >> 1.08.

Dostępne długości: 1000 mm, 2000 mm,
3000 mm, 4000 mm. Standardowa tolerancja
długości profili wynosi: +20 mm.
Więcej informacji >> 1.08.

THERMAL TAPE / TAŚMA TERMALNA

thermal tape 45 x 10 mm
self adhesive, double-sided

taśma termalna 45 x 10 mm
samoprzylepna, dwustronna

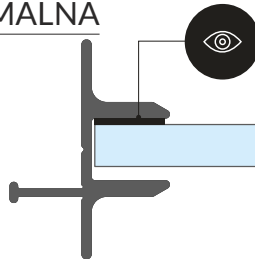

INDEX = 1 pc,
package > check the pricelist
INDEKS = 1 szt.,
opakowanie > patrz cennik

53820000



MIKRO10

A SMALL EDGE PROFILE FOR GLASS PANELS

MAŁY PROFIL KRAWĘDZIOWY DO SZYB

- to illuminate the edge or engraving on the glass panel surface
 - to be used for furniture (display cases) or advertising
 - discreet form
 - fits the 6 mm thick glass panel
 - note: the profile is not a construction element
 - maximum LED strip width: 10 mm
-
- do podświetlania krawędzi lub graweru na płaszczyźnie szyby
 - głównie do zastosowania meblowego (gabloty) lub reklamowego
 - dyskretna forma
 - do szyb o grubości 6 mm
 - uwaga: profil nie jest elementem konstrukcyjnym
 - maksymalna szerokość taśmy LED: 10 mm



SIMILAR IN THE OFFER / PODOBNE W OFERCIE



TWIN8



EDGE10
BC



MIKRO-LINE12



CABI12
E

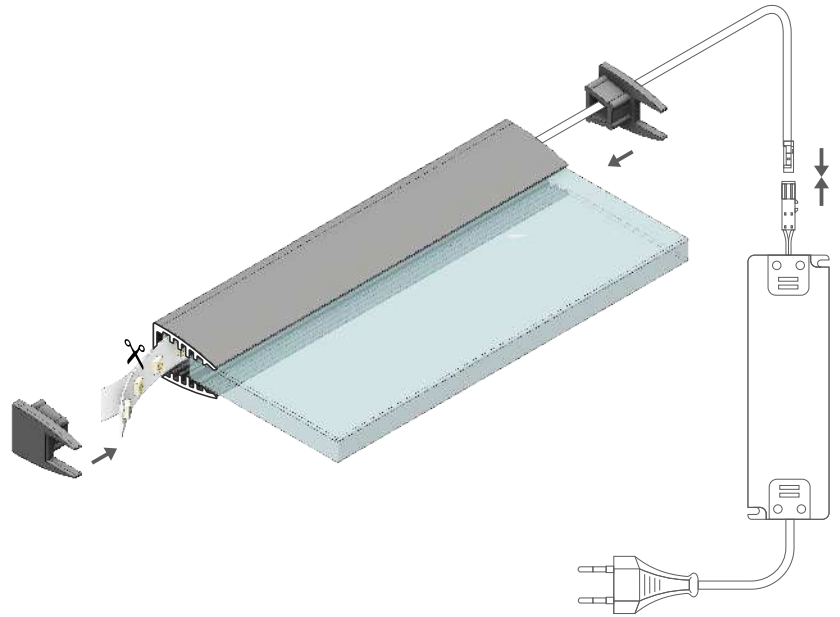
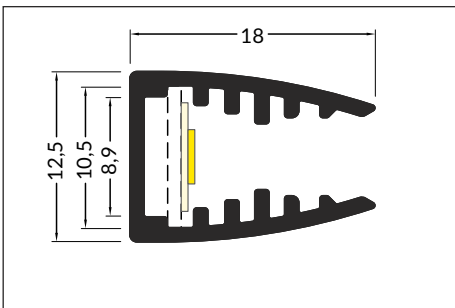
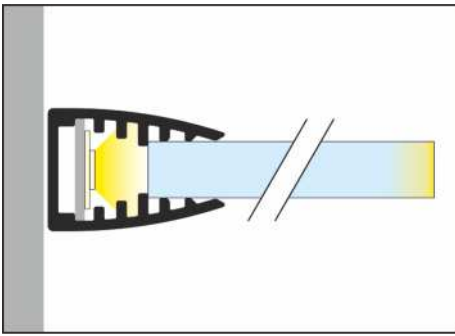

max 10 mm



glass application
do szkła



INDEX = 1 pc, length 2000 mm
package > check the pricelist
INDEKS = 1 szt., długość 2000 mm
opakowanie > patrz cennik

anodized / anodowany
68540020

Available lengths: 1000 mm, 2000 mm,
3000 mm, 4000 mm. The standard profile
length tolerance is +20 mm.
More details >> 1.08.

Dostępne długości: 1000 mm, 2000 mm,
3000 mm, 4000 mm. Standardowa tolerancja
długości profili wynosi: +20 mm.
Więcej informacji >> 1.08.

ENDINGS / ZAŚLEPKI

MIKRO10 ending

colours: silver, grey, transparent

material: ABS, ABS, PC

zaślepka MIKRO10

kolory: srebrny, szary, transparentny

material: ABS, ABS, PC

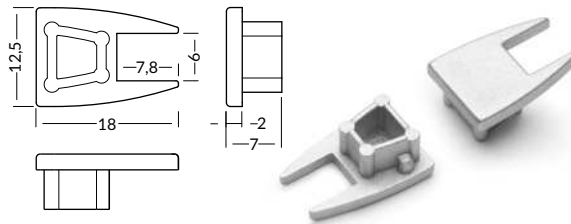

INDEX = 10 sets = 20 pcs
package > check the pricelist
INDEKS = 10 kpl = 20 szt.
opakowanie > patrz cennik

silver / srebrny
68550040

grey / szary
68550022

transparent / transparentny
68550000

LED MOUNTING / MOCOWANIE LED

MIKRO10 LED mounting

material: HIPS

mocowanie LED MIKRO10

material: HIPS

INDEX = 1 pc, length 2000 mm
package > check the pricelist
INDEKS = 1 szt., długość 2000 mm
opakowanie > patrz cennik

68640000

Available lengths / Dostępne długości
1000 mm, 2000 mm



EDGE10 BC

FINISHING EDGES AND LIGHTING OF DISPLAY WINDOWS

WYKOŃCZENIE KRAWĘDZI I OŚWIETLENIE EKSPOZYCJI

- the product for finishing and strengthening display window edges to a thickness up to 8 mm
- suitable for decorative 'framing' of the display window
- light is emitted at an angle - it does not cause glare
- top or bottom illumination
- easy installation - a double-sided tape not visible to customers
- when using on a thinner glass, consider additional wedging or adhesive tape
- maximum LED strip width: 10 mm

- wykańcza i wzmacnia krawędź szyby o grubości do 8 mm
- umożliwia budowanie ramki okalającej szycę
- światło skierowane pod kątem - nie powoduje olśnienia
- oświetlanie od góry lub od dołu
- łatwy montaż poprzez wklejenie - niewidoczne mocowanie taśmą dwustronną
- przy zastosowaniu do cieńszej szyby należy przewidzieć dodatkowe klinowanie lub klejenie taśmą
- maksymalna szerokość taśmy LED: 10 mm



SIMILAR IN THE OFFER / PODOBNE W OFERCIE



TWIN8



MIKRO10



MIKRO-LINE12



FRAME14
BC/Q



CABI12
E



B slide cover
klosz B wsuwany

C click cover
klosz C klik

C lens cover
klosz C soczewka

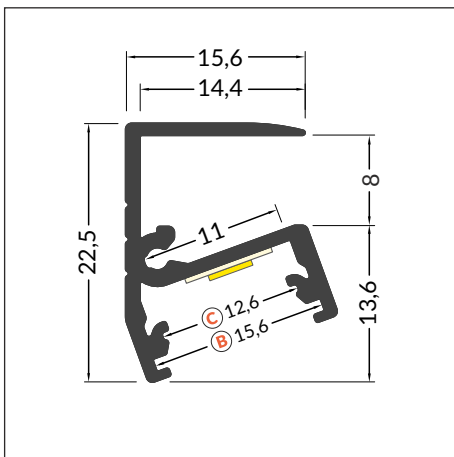
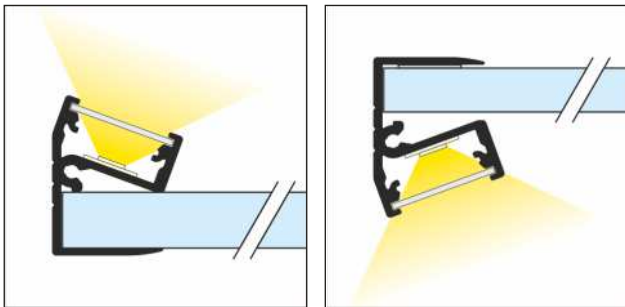
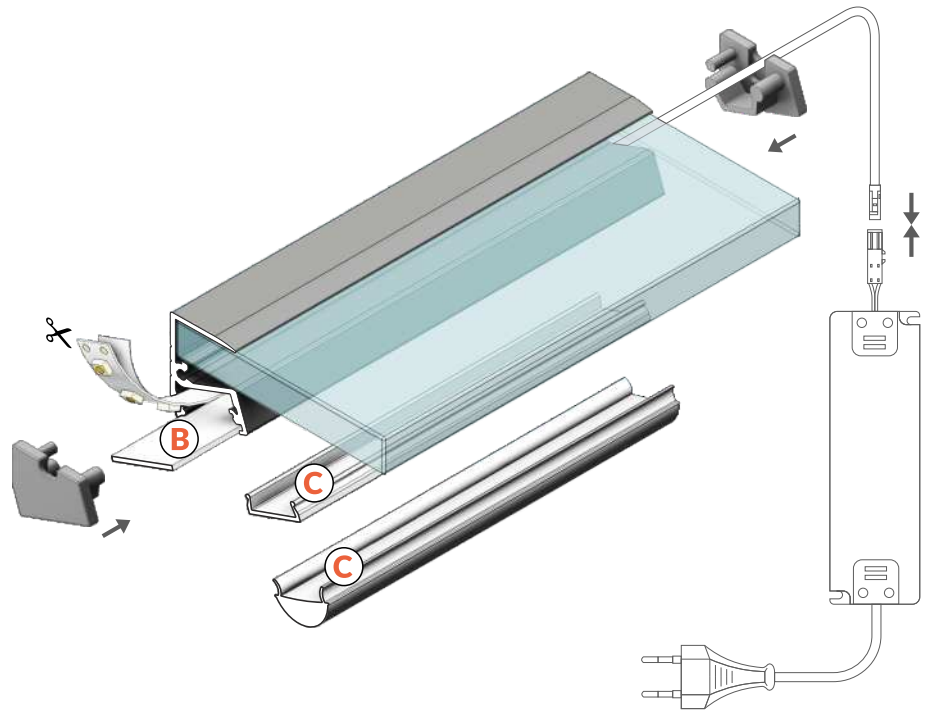

 max 10 mm

 glass application
do szkła

INDEX = 1 pc, length 2000 mm
package > check the pricelist
INDEKS = 1 szt., długość 2000 mm
opakowanie > patrz cennik

white painted
biały malowany
A9020001

anodized
anodowany
A9020020

black anodized
czarny anodowany
A9020021

raw aluminium
surowe aluminium
A9020000

Available lengths: 1000 mm, 2000 mm, 3000 mm, 4000 mm.
The standard profile length tolerance is +20 mm.
More details >> 1.08.

Dostępne długości: 1000 mm, 2000 mm, 3000 mm, 4000 mm.
Standardowa tolerancja długości profili wynosi: +20 mm.
Więcej informacji >> 1.08.



COVERS / KLOSZE

B slide cover
colours: transparent, frosted, opal
material: PC, PP, PP

klosz B wsuwany
kolory: transparentny, szron, mleczny
materiał: PC, PP, PP



Note! Dimensions of the space to install LED source
Uwaga! Wymiary przestrzeni do zamontowania źródła LED

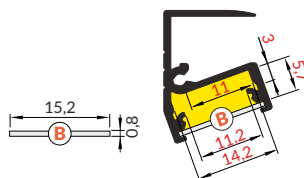

length 2000 mm
package > check the pricelist
długość 2000 mm
opakowanie > patrz cennik

B transparent / B transparentny
index = 10 pcs / indeks = 10 szt.
76250016

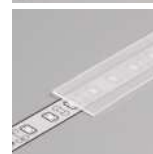

B frosted / B szron
index = 10 pcs / indeks = 10 szt.
76250039

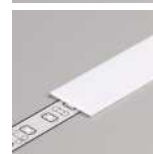

B opal / B mleczny
index = 10 pcs / indeks = 10 szt.
76250038



C transparent / C transparentny
index = 1 pc / indeks = 1 szt.
76330000



C opal / C mleczny
index = 1 pc / indeks = 1 szt.
76330038

C click cover
colours: transparent, opal
material: PMMA

klosz C klik
kolory: transparentny, mleczny
materiał: PMMA

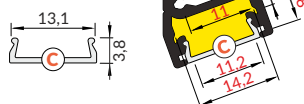

C opal / C mleczny
index = 1 pc / indeks = 1 szt.
76360038S

C lens click cover
colour: transparent
material: PC

klosz C klik soczewka
kolor: transparentny
materiał: PC



length 2000 mm
package > check the pricelist
długość 2000 mm
opakowanie > patrz cennik
C lens / C soczewka
index = 1 pcs / indeks = 1 szt.
76300000

The standard cover length tolerance is +20 mm.
More details >> 1.08.

Standardowa tolerancja długości kloszy wynosi: +20 mm
Więcej informacji >> 1.08.



ENDINGS / ZAŚLEPKI

EDGE10 ending gen2 with hole
colours: white, silver, black, grey
material: ABS

zaślepka EDGE10 gen2 z otworem
kolory: biały, srebrny, czarny, szary
materiał: ABS

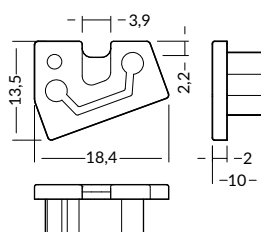

INDEX = 10 sets = 20 pcs
package > check the pricelist
INDEKS = 10 kpl = 20 szt.
opakowanie > patrz cennik

white / biały
A9950001
silver / srebrny
A9950040
black / czarny
A9950002
grey / szary
A9950022

THERMAL TAPE / TAŚMA TERMALNA

thermal tape 45 x 10 mm
self adhesive, double-sided

taśma termalna 45 x 10 mm
samoprzylepna, dwustronna

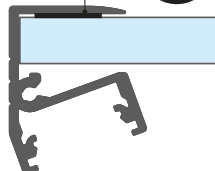

INDEX = 1 pc,
package > check the pricelist
INDEKS = 1 szt.,
opakowanie > patrz cennik

53820000



Depending on the installation method, EDGE10 profile may illuminate the display area from the top or from below.

W zależności od sposobu montażu profil EDGE10 daje możliwość oświetlenia ekspozycji od góry lub od dołu.



MIKRO-LINE12 J

EDGE PROFILE FOR GLASS PANELS

PROFIL KRAWĘDZIOWY DO SZYB

- decorative illumination
- illuminates the edge or engraving on the glass panel surface
- for furniture and advertisement use mainly
- fits the 8 mm glass panels
- note: the profile is not a construction element
- maximum LED strip width: 12 mm

- oświetlenie dekoracyjne
- oświetla krawędź lub grawer na płaszczyźnie szyby
- głównie do użytku meblowego i reklamowego
- pasuje do szyb 8 mm
- uwaga: profil nie jest elementem konstrukcyjnym
- maksymalna szerokość taśmy LED: 12 mm

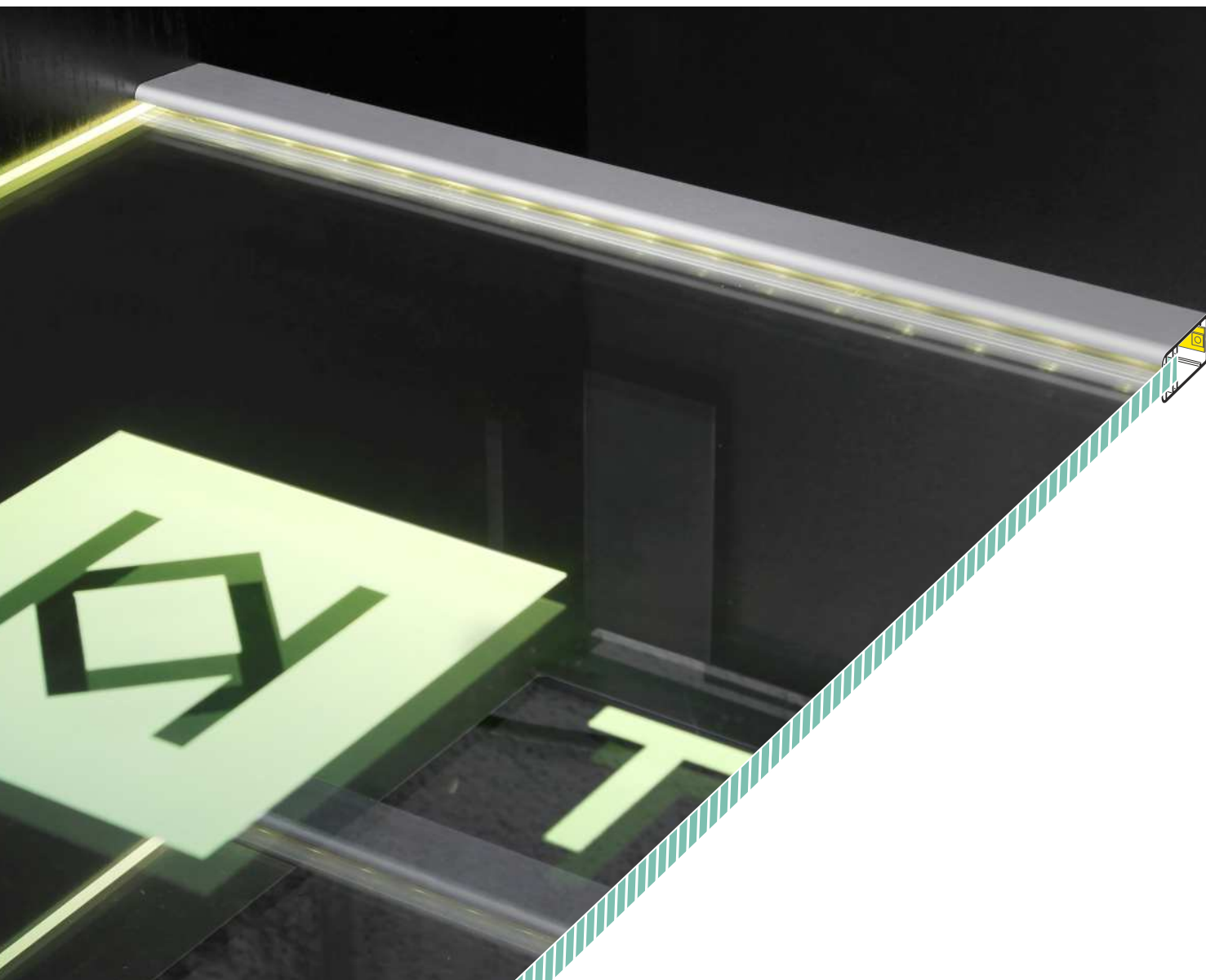

SIMILAR IN THE OFFER / PODOBNE W OFERCIE



TWIN8



EDGE10
BC



MIKRO10



CABI12
E

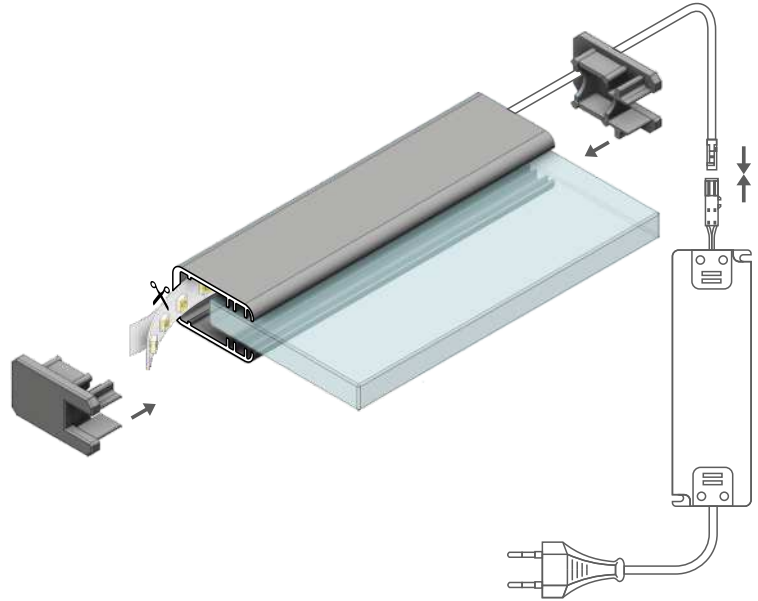
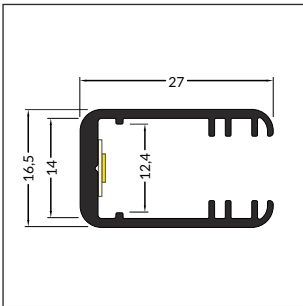
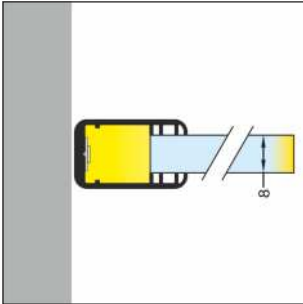

max 12 mm



glass application
do szkła



available in stock
dostępny na magazynie



INDEX = 1 pc, length 2000 mm
package > check the pricelist
INDEKS = 1 szt., długość 2000 mm
opakowanie > patrz cennik

anodized
anodowany
70280020

raw aluminium
surowe aluminium
70280000

Available lengths: 1000 mm, 2000 mm,
3000 mm, 4000 mm. The standard profile
length tolerance is +20 mm.
More details >> 1.08.

Dostępne długości: 1000 mm, 2000 mm,
3000 mm, 4000 mm. Standardowa tolerancja
długości profili wynosi: +20 mm.
Więcej informacji >> 1.08.

ENDINGS / ZAŚLEPKI

MIKRO-LINE12 ending
colours: silver, grey, transparent
material: ABS, ABS, PC
zaślepka MIKRO-LINE12
kolory: srebrny, szary, transparentny
materiał: ABS, ABS, PC

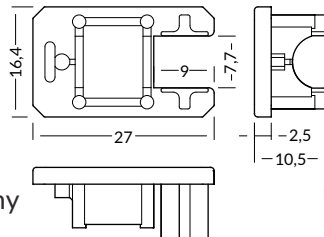

INDEX = 10 sets = 20 pcs
package > check the pricelist
INDEKS = 10 kpl = 20 szt.
opakowanie > patrz cennik

silver / srebrny
70290040

grey / szary
70290022

transparent / transparentny
70290000



Note! Dimensions of the space to install LED source
Uwaga! Wymiary przestrzeni do zamontowania źródła LED

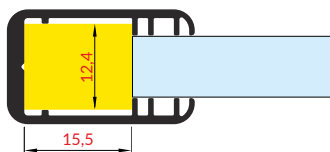

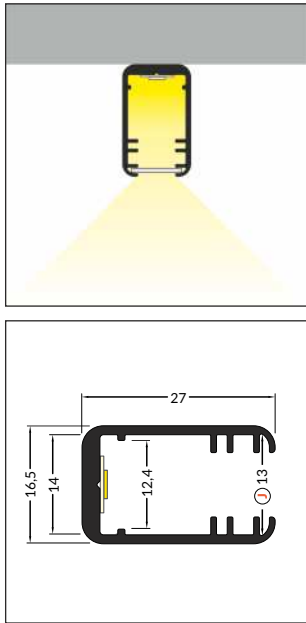

J slide cover
klosz **J** wsuwany

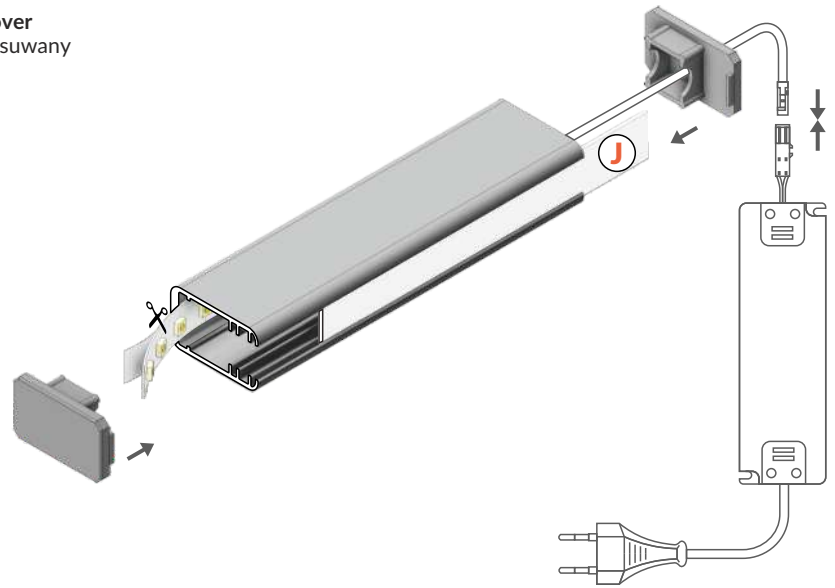

 max 12 mm

 special application
specjalny

 available in stock
dostępny na magazynie



INDEX = 1 pc, length 2000 mm
package > check the pricelist
INDEKS = 1 szt., długość 2000 mm
opakowanie > patrz cennik

anodized
anodowany
70280020

raw aluminium
surowe aluminium
70280000

Available lengths: 1000 mm, 2000 mm,
3000 mm, 4000 mm. The standard profile
length tolerance is +20 mm.
More details >> 1.08.

Dostępne długości: 1000 mm, 2000 mm,
3000 mm, 4000 mm. Standardowa tolerancja
długości profili wynosi: +20 mm.
Więcej informacji >> 1.08.

ENDINGS / ZAŚLEPKI

MIKRO-LINE12 LINIA ending
colours: silver, grey, transparent
material: ABS, ABS, PC
zaślepka MIKRO-LINE12 LINIA
kolory: srebrny, szary, transparentny
materiał: ABS, ABS, PC

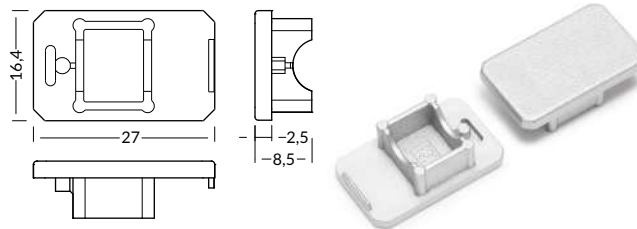

INDEX = 10 sets = 20 pcs
package > check the pricelist
INDEKS = 10 kpl = 20 szt.
opakowanie > patrz cennik

silver / srebrny
70300040

grey / szary
70300022

transparent / transparentny
70300000

COVERS / KLOSZE

J slide cover
colours: transparent, frosted, opal
material: PC, PP, PP

klosz **J** wsuwany
kolory: transparentny, szron, mleczny
materiał: PC, PP, PP

Note! Dimensions of the space
to install LED source
Uwaga! Wymiary przestrzeni
do zamontowania źródła LED

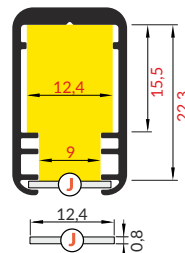

INDEX = 1 pc, length 2000 mm
package > check the pricelist
INDEKS = 1 szt., długość 2000 mm
opakowanie > patrz cennik

J transparent / **J** transparentny
index = 10 pcs / indeks = 10 szt.
70330016

J frosted / **J** szron
index = 10 pcs / indeks = 10 szt.
70330039

J opal / **J** mleczny
index = 10 pcs / indeks = 10 szt.
70330038

The standard cover length tolerance is +20 mm.
More details >> 1.08.

Standardowa tolerancja długości kloszy wynosi: +20 mm
Więcej informacji >> 1.08.

**PROFILE APPLICATION:
ZASTOSOWANIE PROFILU:**



With opal cover - continuous light line.
Z kloszem mlecznym - ciągła linia światła.



With glass panel - illumination of sandblasted edge.
Z szybą - podświetlenie piaskowanej krawędzi.



2020 LED PROFILES

PROFILE LED

VARIO30 / VARIO30

VARIOUS LIGHT IDEAS

SYSTEM ŚWIETLNYCH WARIACJI

- 18 variations and combinations
 - from pendant to recessed
 - housing around the powering supply
 - continuous light line in angular connections
 - unlimited possibilities in creating light
- 18 wariantów i kombinacji
 - od wiszących do wpustowych
 - obudowa wokół zasilania
 - ciągła linia światła w połączeniach kątowych
 - nieograniczone możliwości kreowania światła

an example / przykład
variant 18

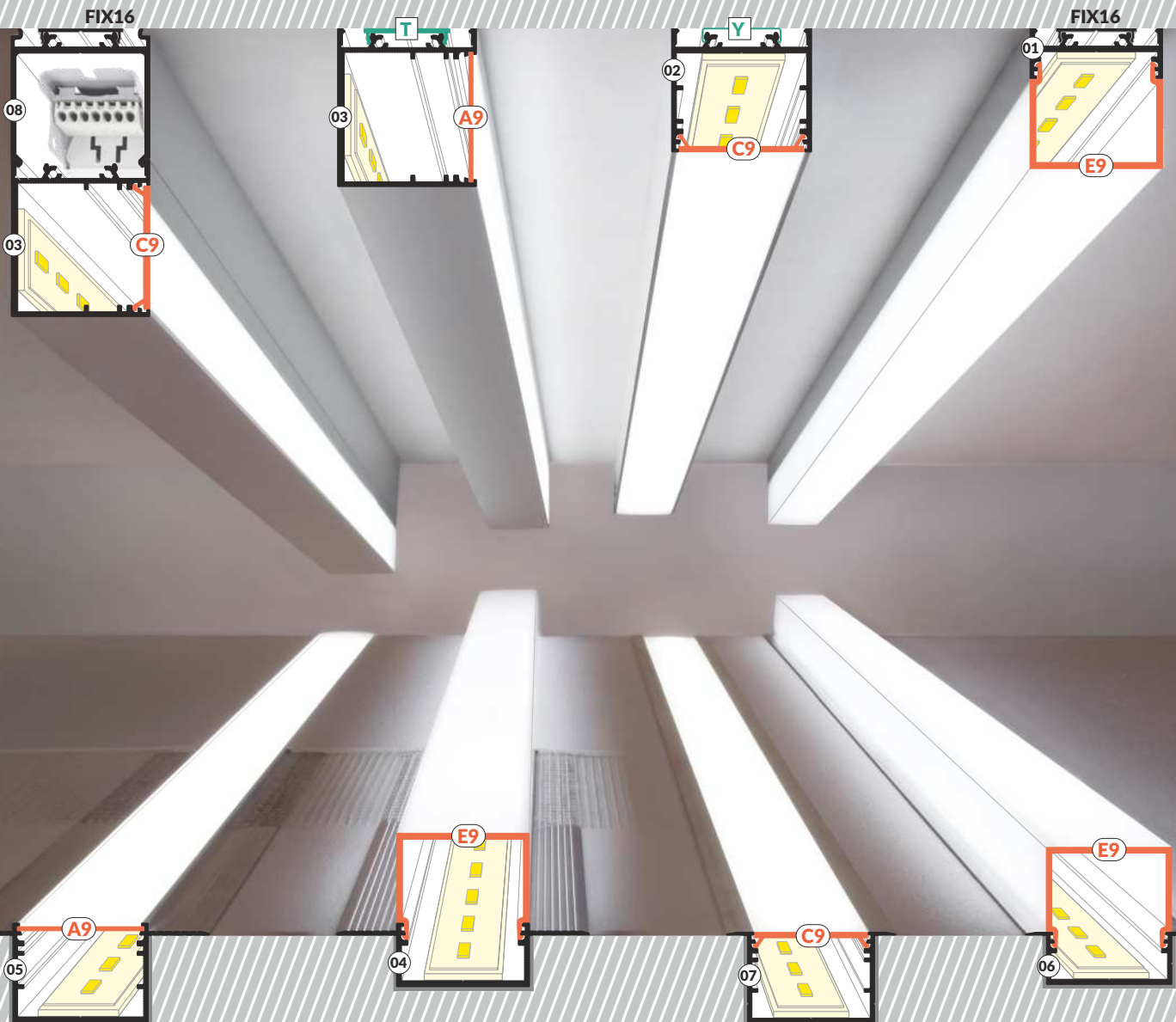
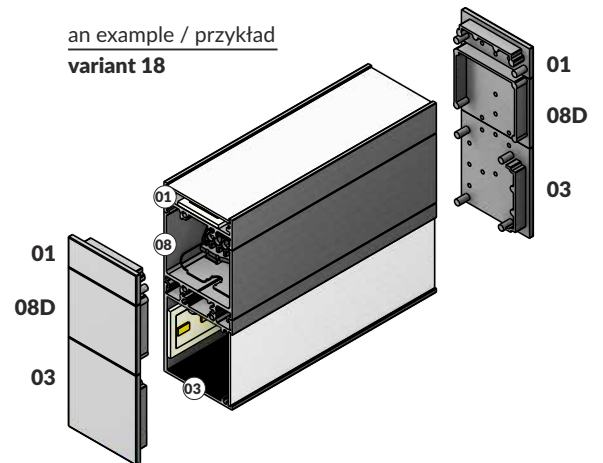

PROMOTED VARIANTS PROMOWANE WARIANTY

variant 27 - pendant 09-08-02-C9
 wariant 27 - wiszący 09-08-02-C9

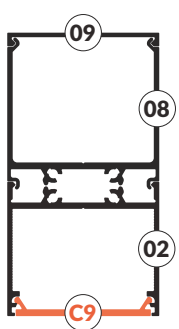

variant 15 - ceiling FIX16-08-01-E9
 wariant 15 - sufitowy FIX16-08-01-E9

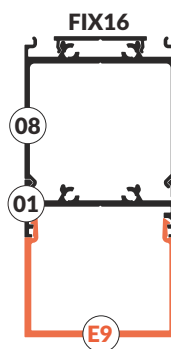

variant 32 - wall side FIX16-08-03-A9
 wariant 32 - ścienny boczny FIX16-08-03-A9

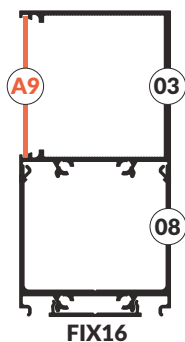

variant 11 - furniture FIX16-01-C9
 wariant 11 - meblowy FIX16-01-C9



variant 06 - recessed 06-E9
 wariant 06 - wpustowy 06-E9

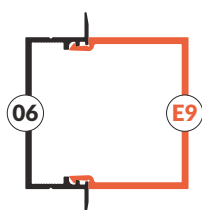

variant 05 - recessed 05-A9 spackle flange
 wariant 05 - wpustowy 05-A9 do szpachlowania

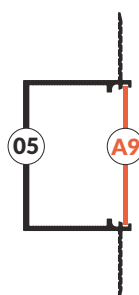

PROMOTED VARIANTS PROMOWANE WARIANTY

BASIC VARIANTS / WARIANTY PODSTAWOWE

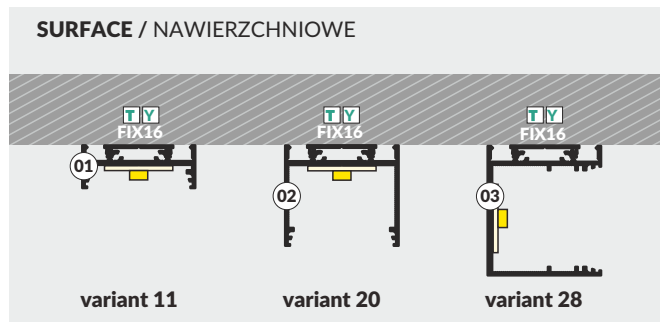
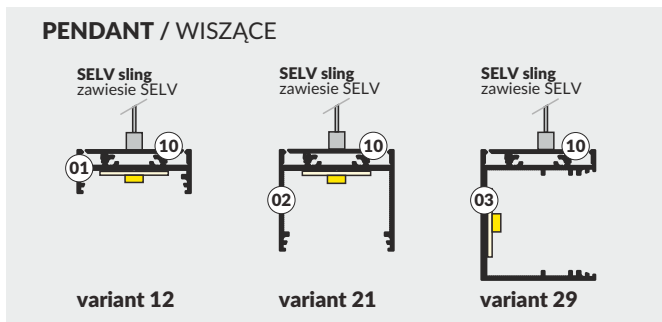

VARIANTS WITH POWER SUPPLY COVER / WARIANTY Z OSŁONĄ ZASILACZA

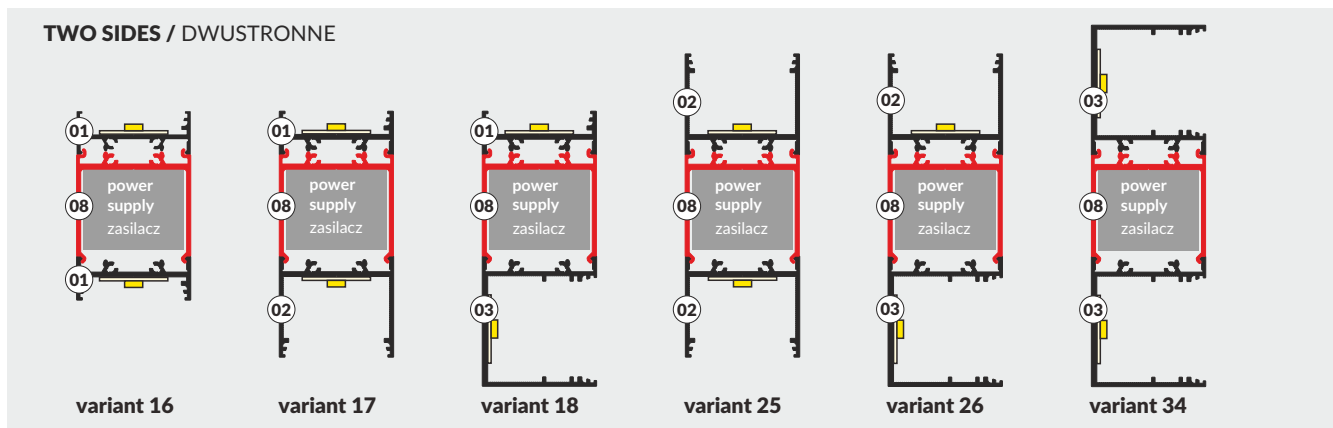
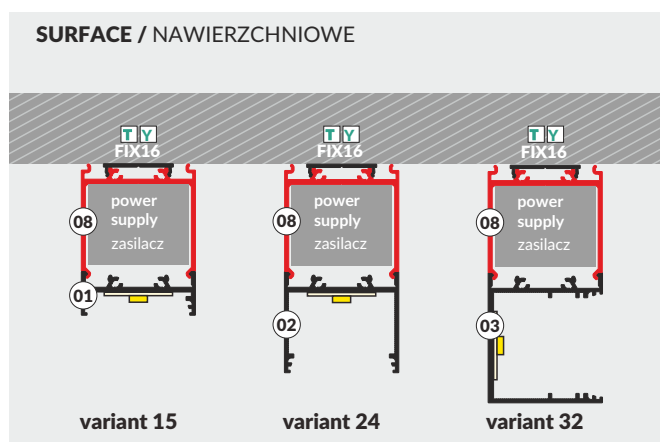
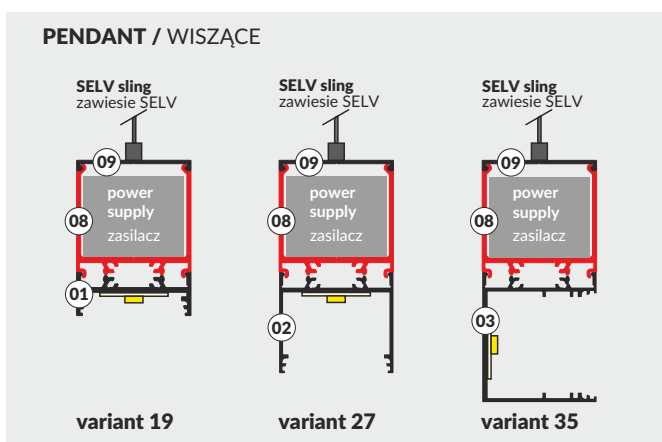

RECESSED VARIANTS / WARIANTY WPUSTOWE

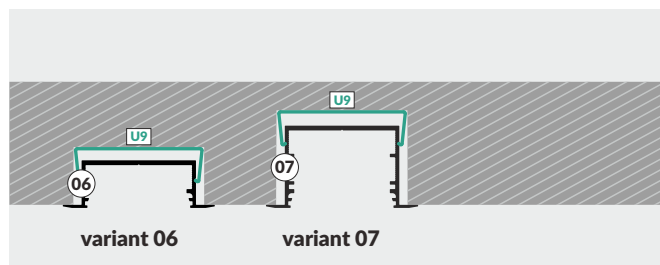
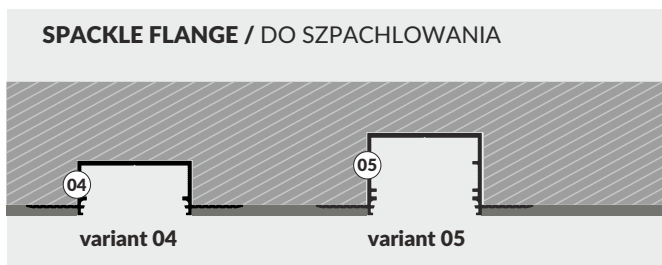

VARIO30

SURFACE / NAWIERZCHNIOWE

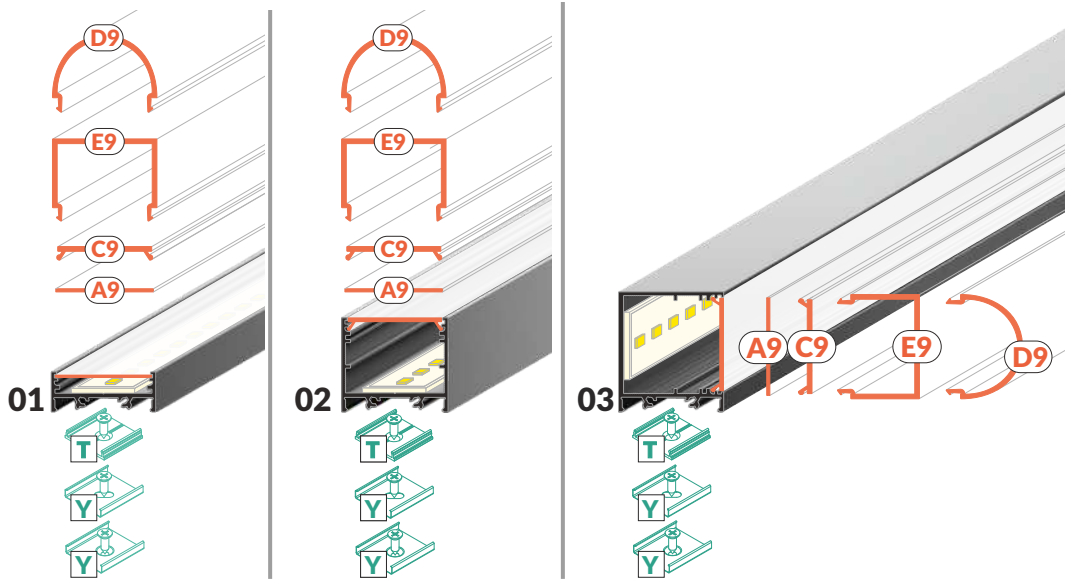

POWER SUPPLY COVER OSŁONA ZASILACZA

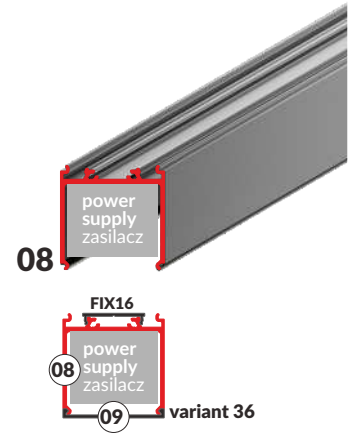

ASSISTANT PROFILES / PROFILE POMOCNICZE

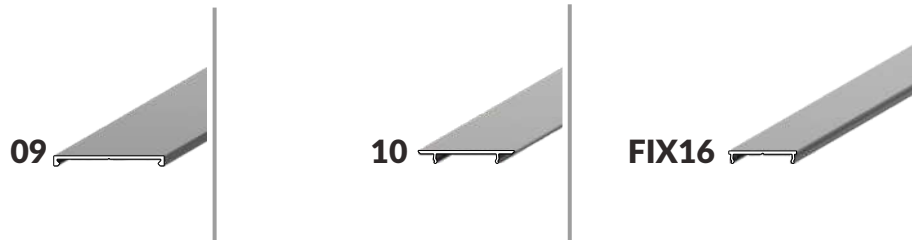

RECESSED SPACKLE FLANGE WPUSTOWE DO SZPACHLOWANIA

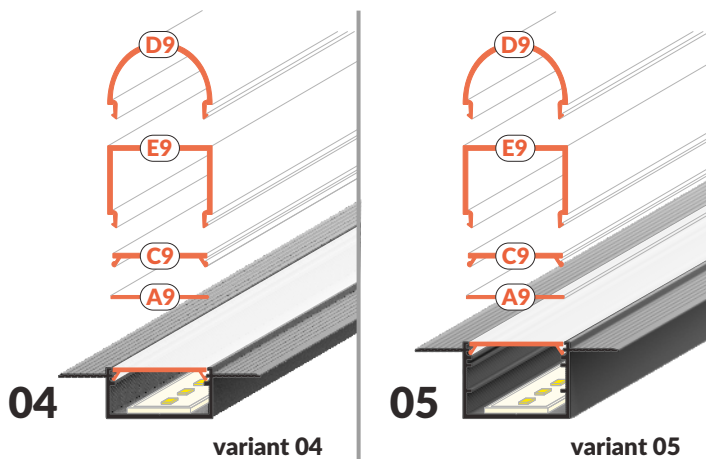

RECESSED WPUSTOWE

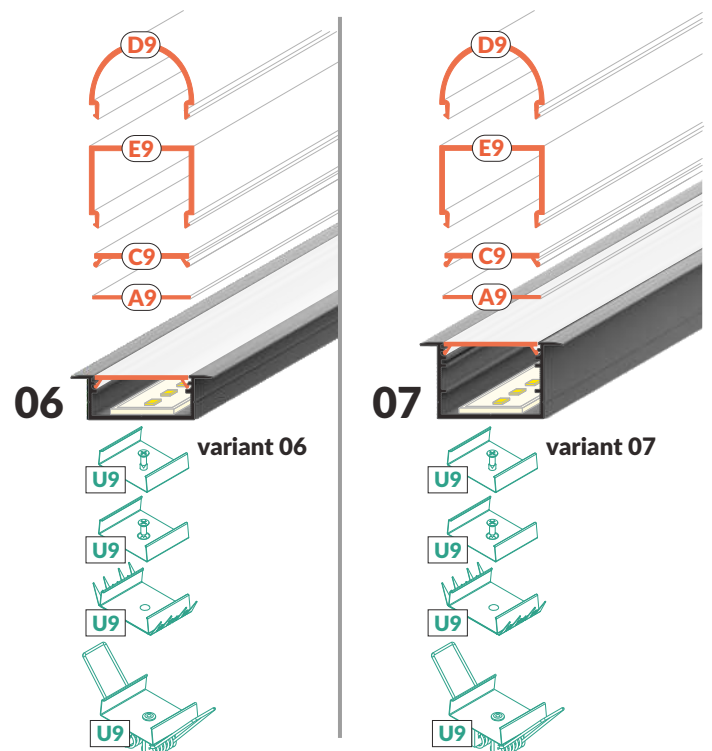

SURFACE PROFILES

PROFILE NAWIERZCHNIOWE



VARIO30-01 > 7.06
VARIO30-02 > 7.06
VARIO30-03 > 7.06
VARIO30-08 > 7.06

VARIO30-09 > 7.07
VARIO30-10 > 7.07
FIX16 > 7.07

mountings / mocowania > 7.08
endings / zaślepki > 7.09
connectors / łączniki > 7.12

diffusers / klosze > 7.18
others / pozostałe > 7.22

SURFACE, POWER SUPPLY COVER NAWIERZCHNIOWE, OSŁONA ZASILANIA

Available in stock
Dostępny na magazynie



LED profile / profil LED VARIO30-01

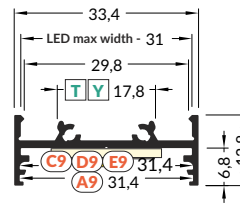
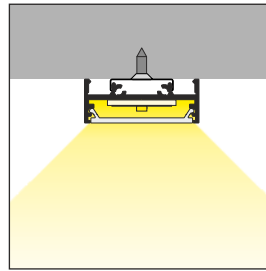

white	anodized	black anodized	raw
biały	anodowany	czarny anodowany	surowy
V3020001	V3020020	V3020021	V3020000

INDEX = 1 pc, length 2000 mm, package > check the pricelist / INDEKS = 1 szt., długość 2000 mm, opakowanie > patrz cennik

LED profile / profil LED VARIO30-02

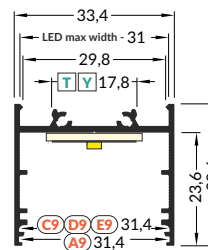
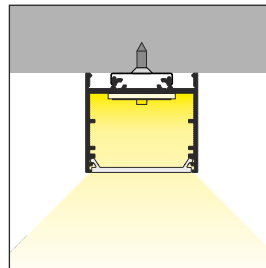

white	anodized	black anodized	raw
biały	anodowany	czarny anodowany	surowy
V3060001	V3060020	V3060021	V3060000

INDEX = 1 pc, length 2000 mm, package > check the pricelist / INDEKS = 1 szt., długość 2000 mm, opakowanie > patrz cennik

LED profile / profil LED VARIO30-03

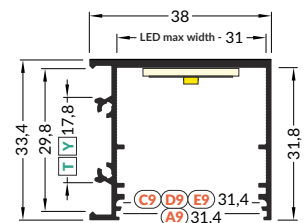
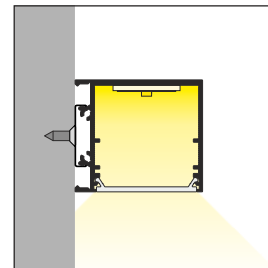
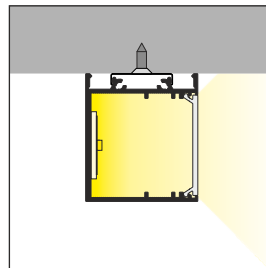

white	anodized	black anodized	raw
biały	anodowany	czarny anodowany	surowy
V3100001	V3100020	V3100021	V3100000

INDEX = 1 pc, length 2000 mm, package > check the pricelist / INDEKS = 1 szt., długość 2000 mm, opakowanie > patrz cennik

power supply profile / profil zasilający VARIO30-08

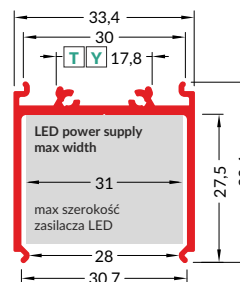
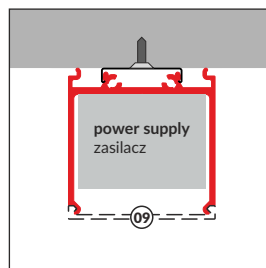

white	anodized	black anodized	raw
biały	anodowany	czarny anodowany	surowy
V3300001	V3300020	V3300021	V3300000

INDEX = 1 pc, length 2000 mm, package > check the pricelist / INDEKS = 1 szt., długość 2000 mm, opakowanie > patrz cennik

Available lengths: 1000 mm, 2000 mm, 3000 mm, 4000 mm. The standard profile length tolerance is +20 mm. More details >> 1.08.
Dostępne długości: 1000 mm, 2000 mm, 3000 mm, 4000 mm. Standardowa tolerancja długości profili wynosi: +20 mm. Więcej informacji >> 1.08.



cover / osłona
VARIO30-09

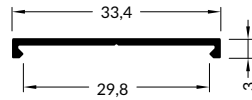

white	anodized	black anodized	raw
biały	anodowany	czarny anodowany	surowy
V3340001	V3340020	V3340021	V3340000

INDEX = 1 pc, length 2000 mm, package > check the pricelist / INDEKS = 1 szt., długość 2000 mm, opakowanie > patrz cennik

cover / osłona
VARIO30-10

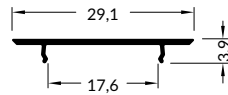

white	anodized	black anodized	raw
biały	anodowany	czarny anodowany	surowy
V3380001	V3380020	V3380021	V3380000

INDEX = 1 pc, length 2000 mm, package > check the pricelist / INDEKS = 1 szt., długość 2000 mm, opakowanie > patrz cennik

LED profile / profil LED
FIX16

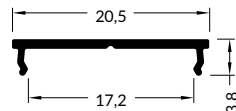

white	anodized	black anodized	raw
biały	anodowany	czarny anodowany	surowy
C6020001	C6020020	C6020021	C6020000

INDEX = 1 pc, length 2000 mm, package > check the pricelist / INDEKS = 1 szt., długość 2000 mm, opakowanie > patrz cennik



Y flexible mounting plate uchwyt Y sprężysty

material: stainless steel
materiał: stal nierdzewna

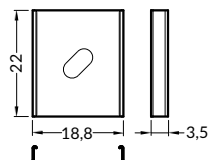

cone Y flexible mounting plate uchwyt Y sprężysty cone

material: stainless steel
materiał: stal nierdzewna

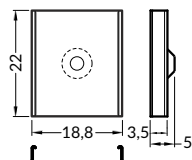

T mounting plate uchwyt T

material: aluminium
materiał: aluminium

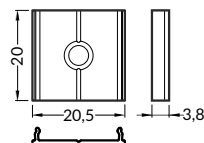

tilted bracket uchwyt uchylny

material: stainless steel, plastic
materiał: stal nierdzewna, tworzywo

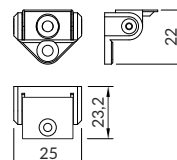

please note you need
the Y mounting plate
that is not included
do kompletu należy dokupić
uchwyt Y sprężysty cone

mountings	inox	raw aluminium		
uchwyty	inox	surowe aluminium		
Y flexible mounting plate / uchwyt Y sprężysty	A2090019	-		
cone Y flexible mounting plate / uchwyt Y sprężysty cone	A2130019	-		
T mounting plate / uchwyt T	-	C6960000		
	white	silver	black	grey
	biały	srebrny	czarny	szary
tilted bracket / uchwyt uchylny	67230001	67230040	67230002	67230022

INDEX = 10 sets = 20 pcs, package > check the pricelist / INDEKS = 10 kpl = 20 szt., opakowanie > patrz cennik



diffuser / cover / profile
klosz / osłona / profil

ending dedicated to VARIO30-08 profile
zaślepka dedykowana do profilu 08

bottom of the LED profile
dół profilu LED

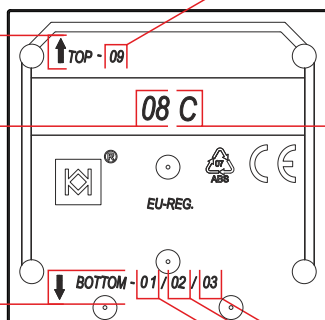

names of profiles fitting with chosen ending:
- VARIO30-09 cover

nazwy profili pasujących do wybranej zaślepki:
- osłona VARIO30-09

type of variant
typ wariantu

names of profiles fitting with chosen ending:
- LED profile VARIO30-01
- LED profile VARIO30-02
- LED profile VARIO30-03

nazwy profili pasujących do wybranej zaślepki:
- profil LED VARIO30-01
- profil LED VARIO30-02
- profil LED VARIO30-03

an example / przykład VARIANT 18

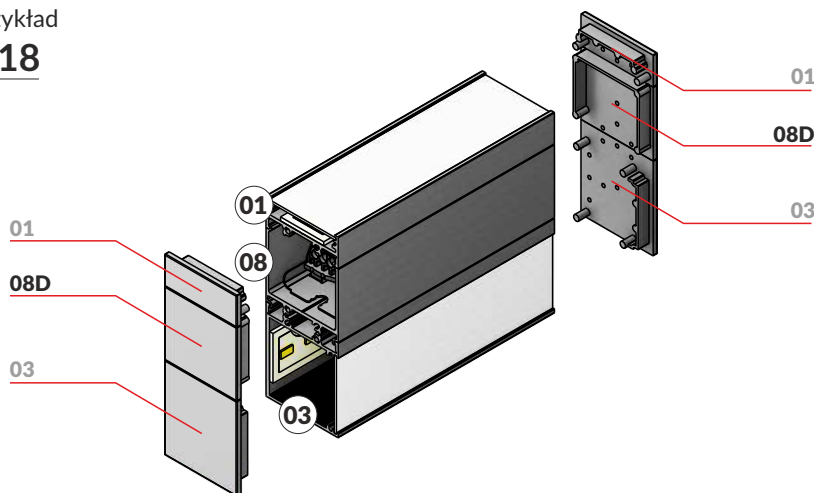

ENDINGS / ZAŚLEPKI

material: ABS

materiał: ABS

VARIO30-01 ending
zaślepka VARIO30-01

VARIO30-02 ending
zaślepka VARIO30-02

VARIO30-03 ending
zaślepka VARIO30-03

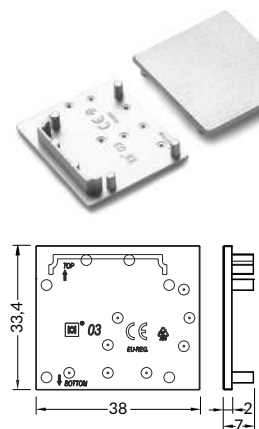
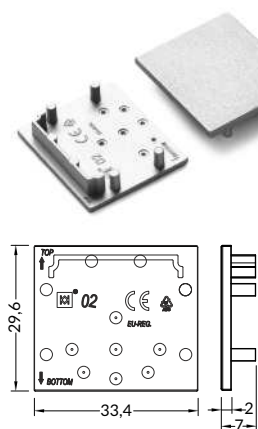
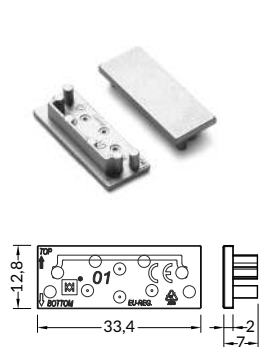

ending for profile zaślepka do profilu	white biały	silver srebrny	black czarny	grey szary
VARIO30-01	V4870001	V4870040	V4870002	V4870022
VARIO30-02	V4880001	V4880040	V4880002	V4880022
VARIO30-03	V4890001	V4890040	V4890002	V4890022

INDEX = 10 sets = 20 pcs, package > check the pricelist / INDEKS = 10 kpl = 20 szt., opakowanie > patrz cennik



VARIO30-08A ending / zaślepka VARIO30-08A

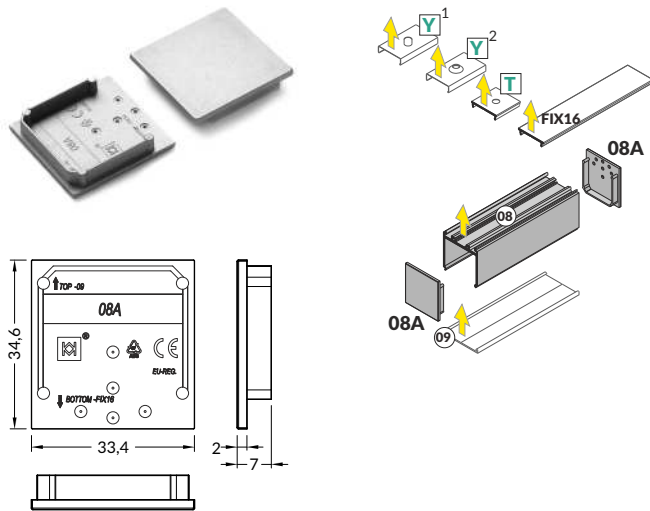

VARIO30-08B ending / zaślepka VARIO30-08B

For variants: 15, 24, 32 / Dla wariantów: 15, 24, 32

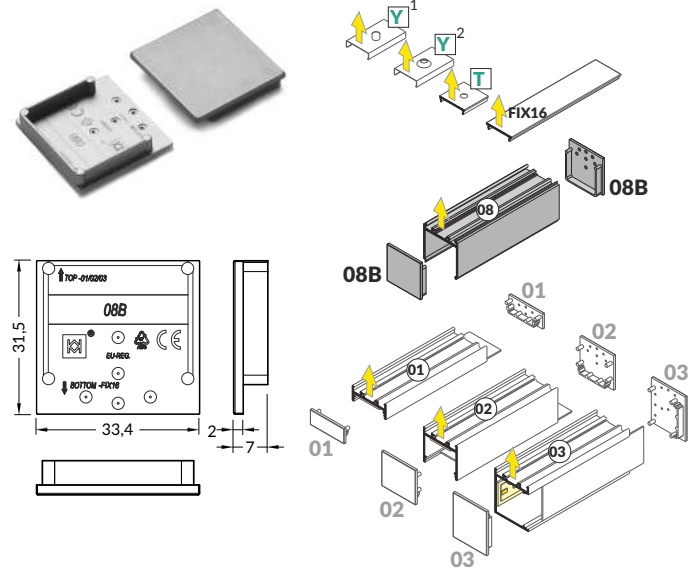

VARIO30-08C ending / zaślepka VARIO30-08C

For variants: 19, 27, 35 / Dla wariantów: 19, 27, 35

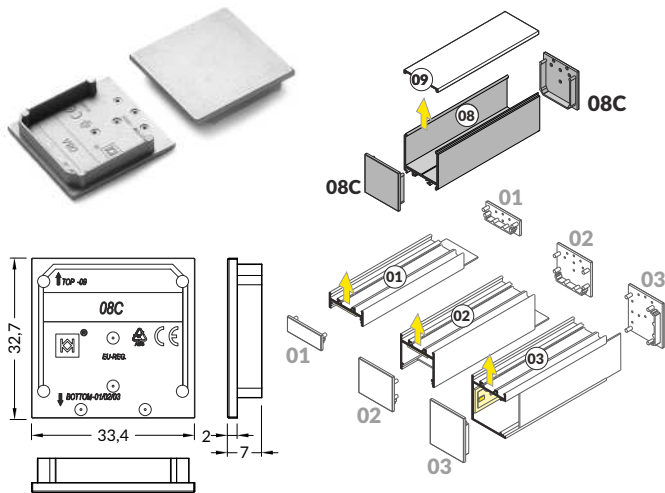

VARIO30-08D ending / zaślepka VARIO30-08D

For variants: 16, 17, 18, 25, 26, 34 / Dla wariantów: 16, 17, 18, 25, 26, 34

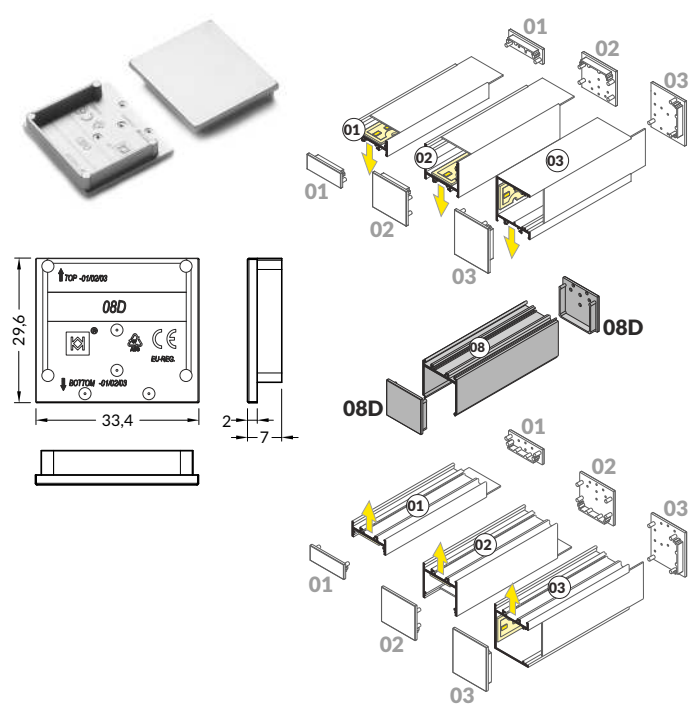

ending for profile	white	silver	black	grey
zaślepka do profilu	biały	srebrny	czarny	szary
VARIO30-08ABCD	V4600001	V4600040	V4600002	V4600022

INDEX = 1 set = 2 x 08A + 2 x 08B + 2 x 08C + 2x08D, package > check the pricelist / INDEKS = 1 kpl = 2 x 08A + 2 x 08B + 2 x 08C + 2x08D, opakowanie > patrz cennik



VARIO30-16-E9 metal ending / zaślepka VARIO30-16-E9 metal

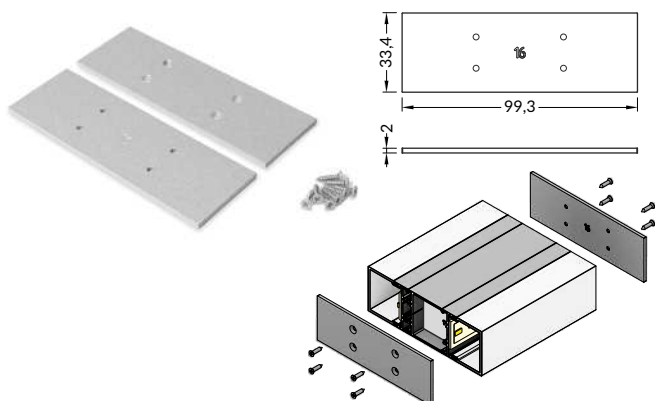

VARIO30-19-E9 metal ending / zaślepka VARIO30-19-E9 metal

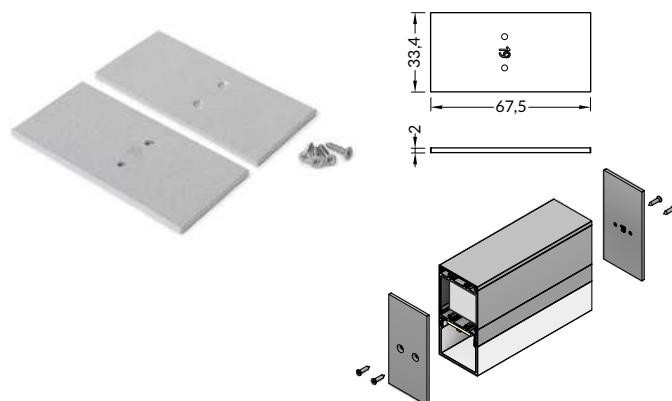

VARIO30-27 metal ending / zaślepka VARIO30-27 metal

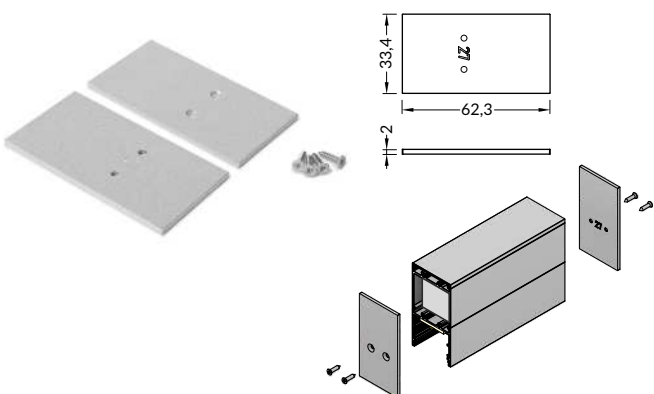

VARIO30-32 metal ending / zaślepka VARIO30-32 metal

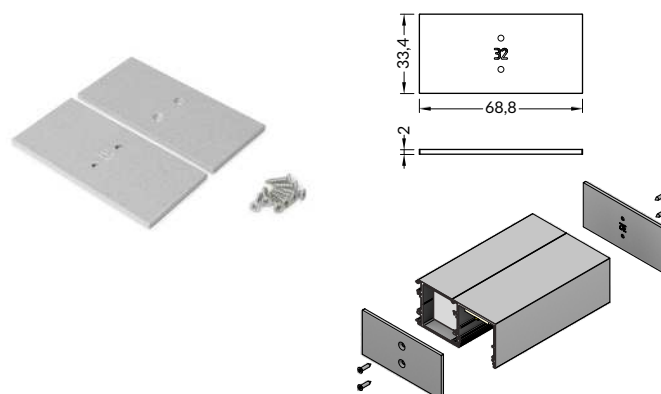

VARIO30-34 metal ending / zaślepka VARIO30-34 metal

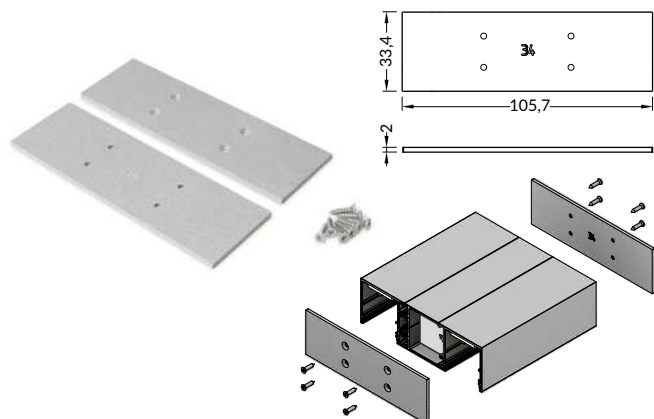

ending for variant

white

silver

black

zaślepka do wariantu

biały

srebrny

czarny

VARIO30-16

V4550001s

V4550022s

V4550002s

VARIO30-19

V4560001s

V4560022s

V4560002s

VARIO30-27

V4570001s

V4570022s

V4570002s

VARIO30-32

V4580001s

V4580022s

V4580002s

VARIO30-34

V4590001s

V4590022s

V4590002s

INDEX = 1 set = 2 pcs, package > check the pricelist / INDEKS = 1 kpl = 2 szt., opakowanie > patrz cennik

for profiles / do profili

VARIO30-02

60 deg / st

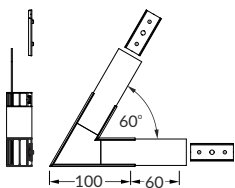

90 deg / st

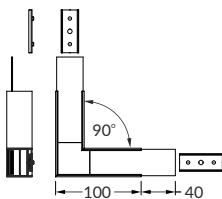

90 deg bent / st gięty

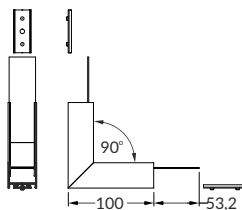

120 deg / st

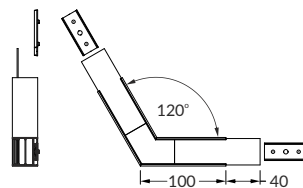

135 deg / st

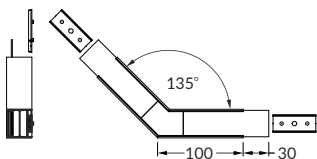

180 deg / st

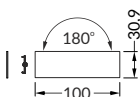

270 deg bent / st gięty

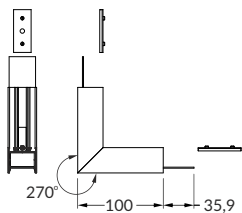

white anodized black anodized

biały anodowany czarny anodowany

VARIO30-02 connector 60 deg / łącznik VARIO30-02 60 st

V4660001s V4660020s V4660021s

VARIO30-02 connector 90 deg / łącznik VARIO30-02 90 st

V4670001s V4670020s V4670021s

VARIO30-02 connector 90 deg bent / łącznik VARIO30-02 90 st gięty

V4680001s V4680020s V4680021s

VARIO30-02 connector 120 deg / łącznik VARIO30-02 120 st

V4690001s V4690020s V4690021s

VARIO30-02 connector 135 deg / łącznik VARIO30-02 135 st

V4700001s V4700020s V4700021s

VARIO30-0203 connector 180 deg / łącznik VARIO30-0203 180 st

- - - V4640000s

VARIO30-02 connector 270 deg bent / łącznik VARIO30 270 st gięty

V4710001s V4710020s V4710021s

INDEX = 1 set, package > check the pricelist / INDEKS = 1 kpl, opakowanie > patrz cennik

for profiles / do profili

VARIO30-03

180 deg / st

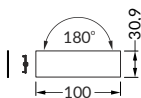

white anodized black anodized

biały anodowany czarny anodowany

VARIO30-0203 connector 180 deg / łącznik VARIO30-0203 180 st

- - - V4640000s

INDEX = 1 set, package > check the pricelist / INDEKS = 1 kpl, opakowanie > patrz cennik

RECESSED PROFILES PROFILE WPUSTOWE

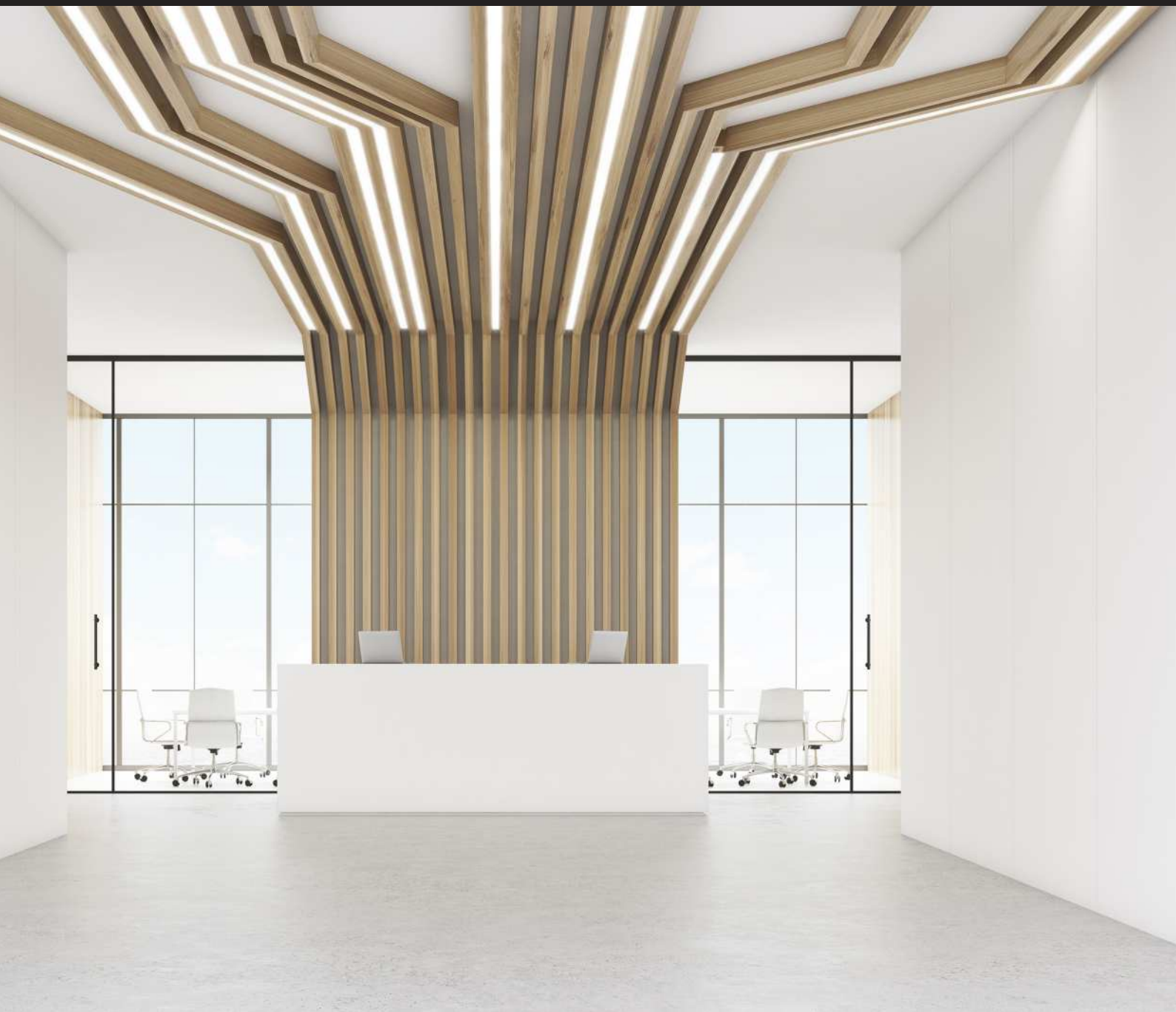

VARIO30-04 > 7.14
VARIO30-05 > 7.14
VARIO30-06 > 7.14
VARIO30-07 > 7.14

mountings / mocowania > 7.15
endings / zaślepki > 7.15
connectors / łączniki > 7.16

diffusers / klosze > 7.18
others / pozostałe > 7.22

RECESSED PROFILES PROFILE WPUSTOWE

Available in stock
Dostępny na magazynie



LED profile / profil LED VARIO30-04

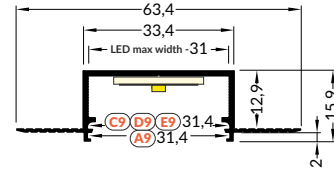
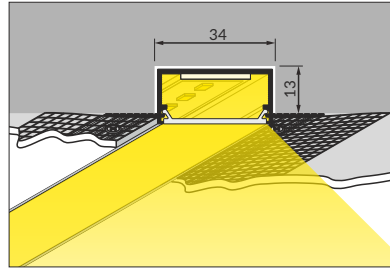

white	anodized	black anodized	raw
biały	anodowany	czarny anodowany	surowy
V3140001	V3140020	-	V3140000

INDEX = 1 pc, length 2000 mm, package > check the pricelist / INDEKS = 1 szt., długość 2000 mm, opakowanie > patrz cennik

LED profile / profil LED VARIO30-05

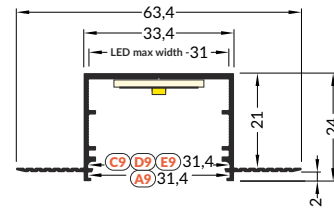
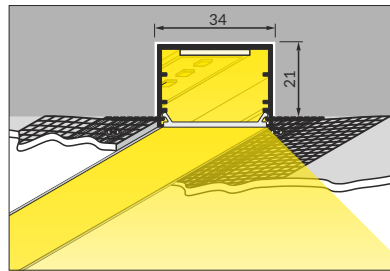

white	anodized	black anodized	raw
biały	anodowany	czarny anodowany	surowy
V3180001	V3180020	-	V3180000

INDEX = 1 pc, length 2000 mm, package > check the pricelist / INDEKS = 1 szt., długość 2000 mm, opakowanie > patrz cennik

LED profile / profil LED VARIO30-06

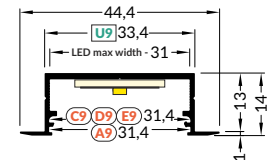
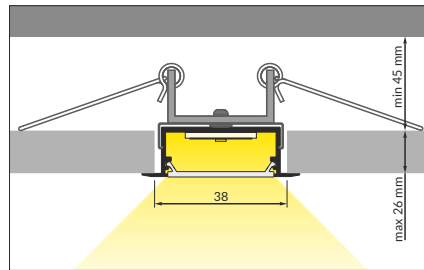
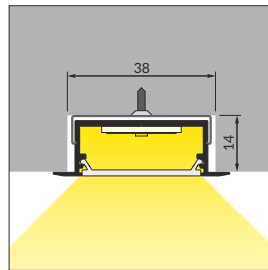

white	anodized	black anodized	raw
biały	anodowany	czarny anodowany	surowy
V3220001	V3220020	V3220021	V3220000

INDEX = 1 pc, length 2000 mm, package > check the pricelist / INDEKS = 1 szt., długość 2000 mm, opakowanie > patrz cennik

LED profile / profil LED VARIO30-07

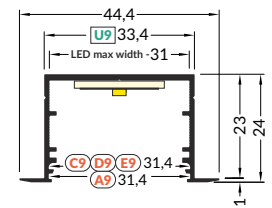
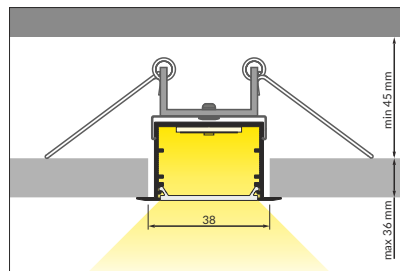
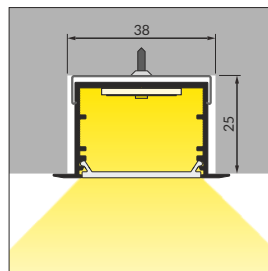

white	anodized	black anodized	raw
biały	anodowany	czarny anodowany	surowy
V3260001	V3260020	V3260021	V3260000

INDEX = 1 pc, length 2000 mm, package > check the pricelist / INDEKS = 1 szt., długość 2000 mm, opakowanie > patrz cennik

Available lengths: 1000 mm, 2000 mm, 3000 mm, 4000 mm. The standard profile length tolerance is +20 mm. More details >> 1.08.

Dostępne długości: 1000 mm, 2000 mm, 3000 mm, 4000 mm. Standardowa tolerancja długości profili wynosi: +20 mm. Więcej informacji >> 1.08.



MOUNTINGS / MOCOWANIA

U9 mounting plate
uchwyt U9

material: stainless steel
materiał: stal nierdzewna

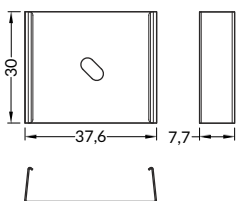

cone U9 mounting plate
uchwyt U9 cone

material: stainless steel
materiał: stal nierdzewna

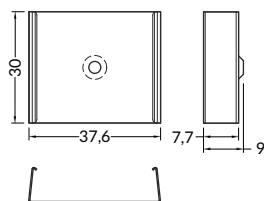

rack U9 mounting plate
uchwyt U9 rack

material: stainless steel
materiał: stal nierdzewna

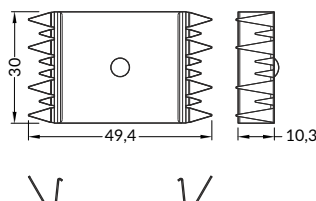

spring U9 mounting plate
uchwyt U9 sprężyna

material: stainless steel, aluminium
materiał: stal nierdzewna, aluminium

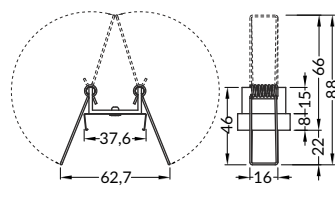

mountings

uchwyty

U9 mounting plate / uchwyt U9

cone U9 mounting plate / uchwyt U9 cone

inox

inox

V4840019

V4850019

INDEX = 10 sets = 20 pcs, package > check the pricelist / INDEKS = 10 kpl = 20 szt., opakowanie > patrz cennik

rack U9 mounting plate / uchwyt U9 rack

spring U9 mounting plate / uchwyt U9 sprężyna

V4860019

V4620019s

INDEX = 1 set = 2 pcs, package > check the pricelist / INDEKS = 1 kpl = 2 szt., opakowanie > patrz cennik

ENDINGS / ZAŚLEPKI

material: ABS

materiał: ABS

VARIO30-04 ending
zaślepka VARIO30-04

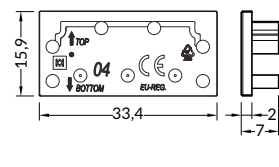

VARIO30-05 ending
zaślepka VARIO30-05

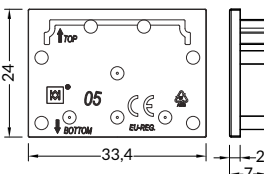
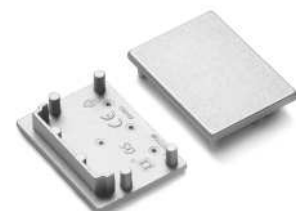

VARIO30-06 ending
zaślepka VARIO30-06

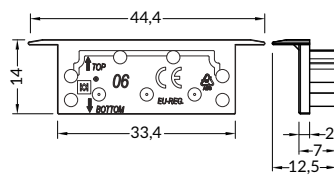

VARIO30-07 ending
zaślepka VARIO30-07

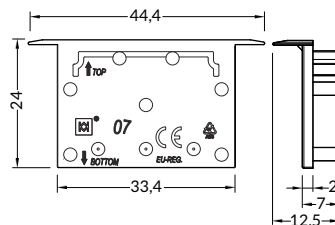
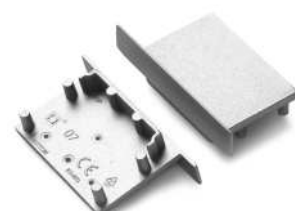

ending for profile

white

silver

black

grey

zaślepka do profilu

biały

srebrny

czarny

szary

VARIO30-04

V4900001

V4900040

-

V4900022

VARIO30-05

V4910001

V4910040

-

V4910022

VARIO30-06

V4920001

V4920040

V4920040

V4920022

VARIO30-07

V4930001

V4930040

V4930002

V4930022

INDEX = 10 sets = 20 pcs, package > check the pricelist / INDEKS = 10 kpl = 20 szt., opakowanie > patrz cennik

for profiles / do profili

VARIO30-05

60 deg / st

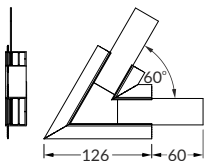

135 deg / st

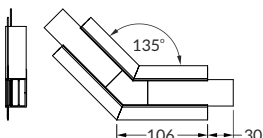

90 deg / st

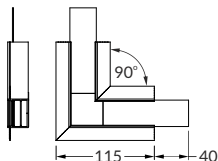

180 deg / st

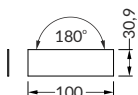

90 deg bent / st gięty

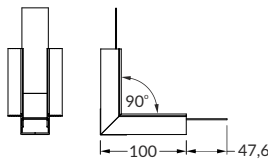

270 deg bent / st gięty

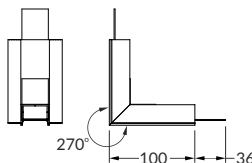

120 deg / st

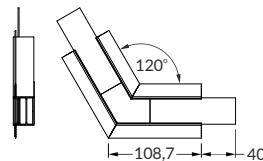

white	anodized	black anodized
biały	anodowany	czarny anodowany

VARIO30-05 connector 60 deg / łącznik VARIO30-05 60 st	V4720001s	V4720020s	-
VARIO30-05 connector 90 deg / łącznik VARIO30-05 90 st	V4730001s	V4730020s	-
VARIO30-05 connector 90 deg bent / łącznik VARIO30-05 90 st gięty	V4740001s	V4740020s	-
VARIO30-05 connector 120 deg / łącznik VARIO30-05 120 st	V4750001s	V4750020s	-
VARIO30-05 connector 135 deg / łącznik VARIO30-05 135 st	V4760001s	V4760020s	-
VARIO30-05 connector 180 deg / łącznik VARIO30-05 180 st	-	-	V4650000s
VARIO30-05 connector 270 deg bent / łącznik VARIO30-05 270 st gięty	V4770001s	V4770020s	-

INDEX = 1 set, package > check the pricelist / INDEKS = 1 kpl, opakowanie > patrz cennik

for profiles / do profili

VARIO30-07

60 deg / st

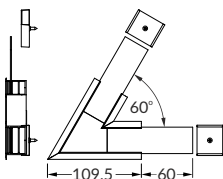

135 deg / st

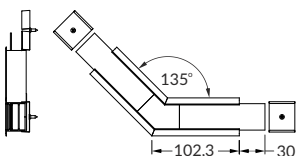

90 deg / st

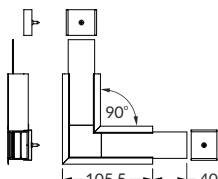

180 deg / st

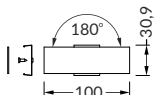

90 deg bent / st gięty

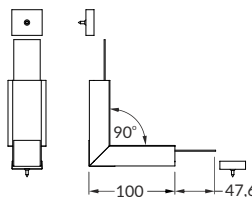

270 deg bent / st gięty

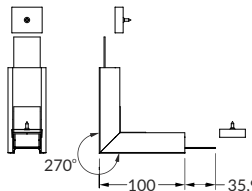

120 deg / st

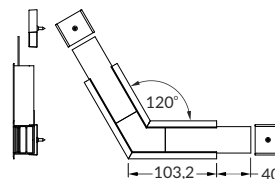

white	anodized	black anodized
biały	anodowany	czarny anodowany

VARIO30-07 connector 60 deg / łącznik VARIO30-07 60 st	V4780001s	V4780020s	V4780021s
VARIO30-07 connector 90 deg / łącznik VARIO30-07 90 st	V4790001s	V4790020s	V4790021s
VARIO30-07 connector 90 deg bent / łącznik VARIO30-07 90 st gięty	V4800001s	V4800020s	V4800021s
VARIO30-07 connector 120 deg / łącznik VARIO30-07 120 st	V4810001s	V4810020s	V4810021s
VARIO30-07 connector 135 deg / łącznik VARIO30-07 135 st	V4820001s	V4820020s	V4820021s
VARIO30-07 connector 180 deg / łącznik VARIO30-07 180 st	-	-	V4610000s
VARIO30-07 connector 270 deg bent / łącznik VARIO30-07 270 st gięty	V4830001s	V4830020s	V4830021s

INDEX = 1 set, package > check the pricelist / INDEKS = 1 kpl, opakowanie > patrz cennik

SYSTEM ACCESSORIES AKCESORIA SYSTEMOWE



diffusers / klosze
others / pozostałe

> 7.18
> 7.22



A9 slide diffuser / klosz A9 wsuwany

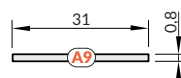
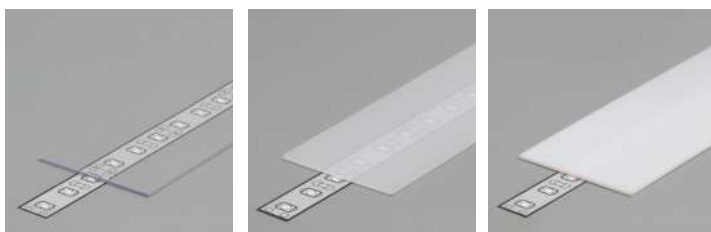

transparent
material: PC
transparentny
materiał: PC

frosted
material: PP
szron
materiał: PP

opal
material: PP
mleczny
materiał: PP



Note! Dimensions of the space to install LED source / Uwaga! Wymiary przestrzeni do zamontowania źródła LED

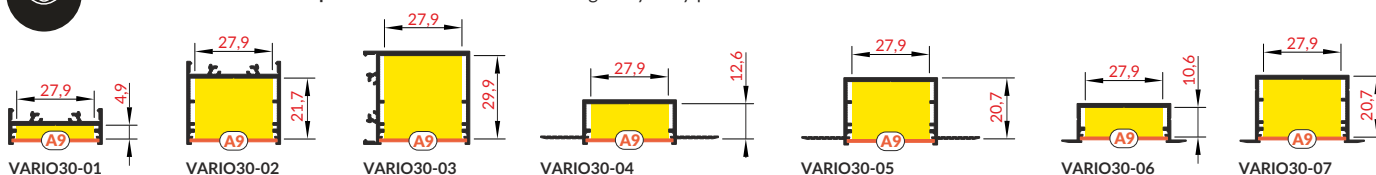

	transparent	frosted	opal
	transparentny	szron	mleczny
A9 slide diffuser / klosz A9 wsuwany	V3420016	V3420039	V3420038

INDEX = 10 pcs, length 2000 mm, package > check the pricelist / INDEKS = 10 szt., długość 2000 mm, opakowanie > patrz cennik

C9 click diffuser / klosz C9 klik

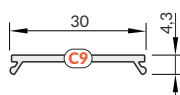

transparent
material: PMMA
transparentny
materiał: PMMA

opal
material: PMMA
mleczny
materiał: PMMA



Note! Dimensions of the space to install LED source / Uwaga! Wymiary przestrzeni do zamontowania źródła LED

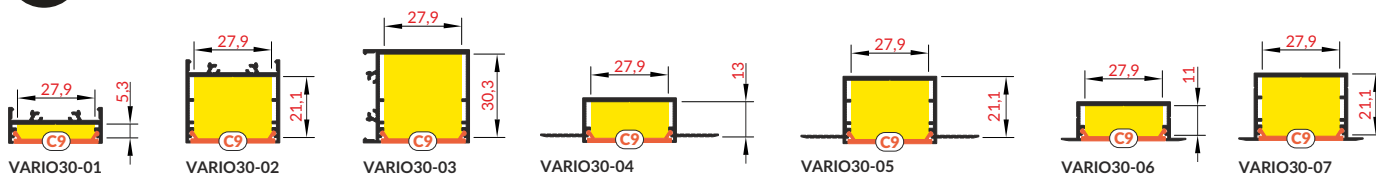

	transparent	frosted	opal
	transparentny	szron	mleczny
C9 click diffuser / klosz C9 klik	V3460016	-	V3460038

INDEX = 1 pc, length 2000 mm, package > check the pricelist / INDEKS = 1 szt., długość 2000 mm, opakowanie > patrz cennik



D9 click diffuser / klosz D9 klik

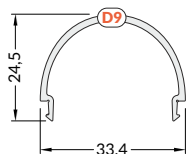

opal
material: PMMA
mleczny
material: PMMA



Note! Dimensions of the space to install LED source / Uwaga! Wymiary przestrzeni do zamontowania źródła LED

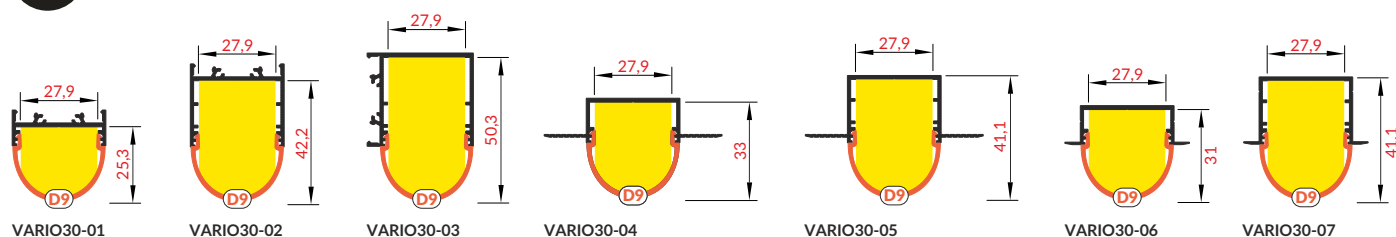

	transparent	frosted	opal
	transparentny	szron	mleczny
D9 click diffuser / klosz D9 klik	-	-	V3500038

INDEX = 1 pc, length 2000 mm, package > check the pricelist / INDEKS = 1 szt., długość 2000 mm, opakowanie > patrz cennik

The standard diffuser length tolerance is +20 mm. More details >> 1.08.
Standardowa tolerancja długości kloszy wynosi: +20 mm. Więcej informacji >> 1.08.

ENDINGS FOR D9 DIFFUSER / ZAŚLEPKI DO KLOSZA D9

material: PMMA

material: PMMA

D9 ending
zaślepka D9

VARIO30-01-D9 ending
zaślepka VARIO30-01-D9

VARIO30-02-D9 ending
zaślepka VARIO30-02-D9

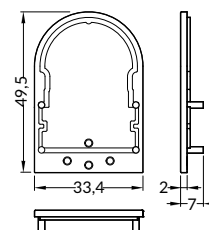
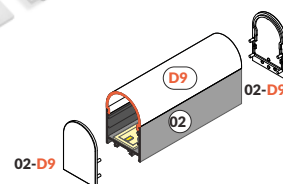
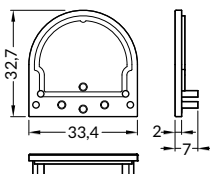
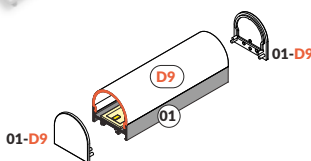
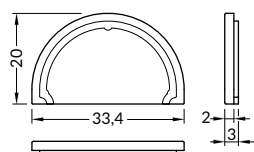
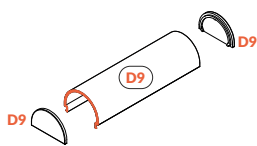

opal
mleczny

D9 ending / zaślepka D9	V4980038
VARIO30-01-D9 ending / zaślepka VARIO30-01-D9	V4500038
VARIO30-02-D9 ending / zaślepka VARIO30-02-D9	V4540038

INDEX = 10 sets = 20 pcs, package > check the pricelist / INDEKS = 10 kpl = 20 szt., opakowanie > patrz cennik



E9 click diffuser / klosz E9 klik

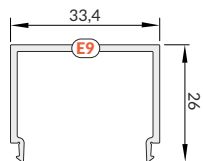

opal
material: PMMA
mleczny
material: PMMA



Note! Dimensions of the space to install LED source / Uwaga! Wymiary przestrzeni do zamontowania źródła LED

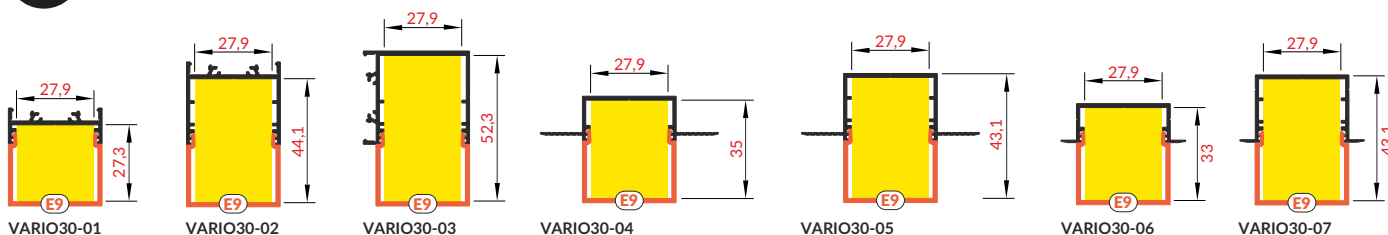

	transparent	frosted	opal
	transparentny	szron	mleczny
E9 click diffuser / klosz E9 klik	-	-	V3540038

INDEX = 1 pc, length 2000 mm, package > check the pricelist / INDEKS = 1 szt., długość 2000 mm, opakowanie > patrz cennik

The standard diffuser length tolerance is +20 mm. More details >> 1.08.
Standardowa tolerancja długości kloszy wynosi: +20 mm. Więcej informacji >> 1.08.

ENDINGS FOR E9 DIFFUSER

material: PMMA

ZAŚLEPKI DO KLOSZA E9

material: PMMA

E9 ending
zaślepka E9

VARIO30-01-E9 ending
zaślepka VARIO30-01-E9

VARIO30-02-E9 ending
zaślepka VARIO30-02-E9

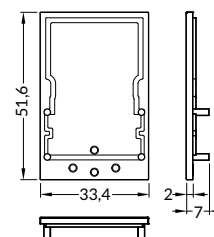
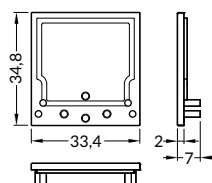
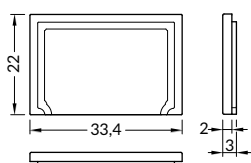
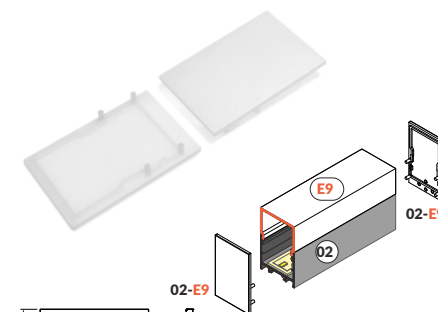
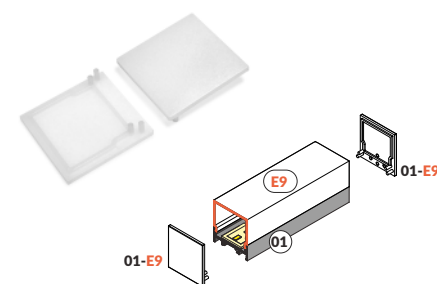
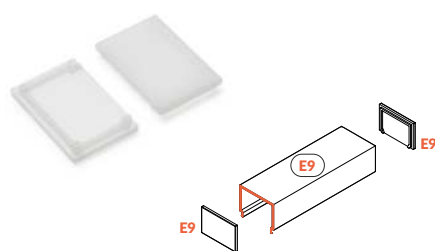

opal

mleczny

E9 ending / zaślepka E9

V4990038

VARIO30-01-E9 ending / zaślepka VARIO30-01-E9

V4510038

VARIO30-02-E9 ending / zaślepka VARIO30-02-E9

V4550038

INDEX = 10 sets = 20 pcs, package > check the pricelist / INDEKS = 10 kpl = 20 szt., opakowanie > patrz cennik

LIGHTING EFFECT EFEKT ŚWIECENIA

VARIO30 reflector + **VARIO30-1 LED clamp**
odbłyśnik VARIO30 + docisk LED VARIO30-1

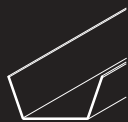

Recommended for profiles:
Rekomendowane dla profili:
02, 03 > 7.06
05, 07 > 7.14
and diffusers: / oraz kloszy:
A9, C9, D9, E9 > 7.18

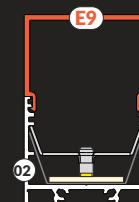

VARIO30 LED mounting + **VARIO30 LED clamp**
mocowanie LED VARIO30 + docisk LED VARIO30

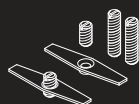

Recommended for profiles:
Rekomendowane dla profili:
02, 03 > 7.06
05, 07 > 7.14
and diffusers: / oraz kloszy:
A9, C9, D9, E9 > 7.18

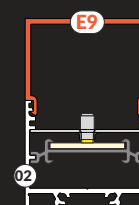
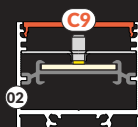

VARIO30-1 LED clamp
docisk LED VARIO30-1



Recommended for profiles:
Rekomendowane dla profili:
02, 03 > 7.06
05, 07 > 7.14
and diffusers: / oraz kloszy:
A9, C9, D9, E9 > 7.18

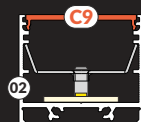

VARIO30 LED clamp
docisk LED VARIO30



Recommended for profiles:
Rekomendowane dla profili:
04, 06 > 7.14
and diffusers: / oraz kloszy:
A9, C9, D9, E9 > 7.18





VARIO30 LED clamp
docisk LED VARIO30

material: steel, plastic
materiał: stal, tworzywo

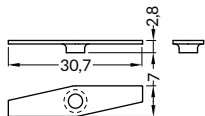

VARIO30-1 LED clamp
docisk LED VARIO30-1

material: steel, plastic
materiał: stal, tworzywo

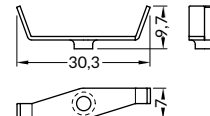

white painted

biały malowany

VARIO30 LED clamp / docisk LED VARIO30

V4630001

VARIO30-1 LED clamp / docisk LED VARIO30-1

V4520001

INDEX = 10 sets = 20 pcs / INDEKS = 10 kpl = 20 szt.

VARIO30 reflector
odbłyśnik VARIO30

material: aluminium
materiał: aluminium

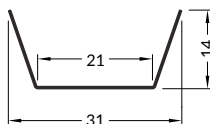

VARIO30 reflector / odbłyśnik VARIO30

V3620000

INDEX = 1 pc, length 2000 mm, package > check the pricelist
INDEKS = 1 szt., długość 2000 mm, opakowanie > patrz cennik

VARIO30 LED mounting
mocowanie LED VARIO30

material: aluminium
materiał: aluminium

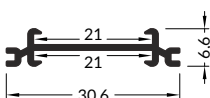

VARIO30 LED mounting / mocowanie LED VARIO30

raw aluminium

surowe aluminium

V3580000

INDEX = 1 pc, length 2000 mm, package > check the pricelist
INDEKS = 1 szt., długość 2000 mm, opakowanie > patrz cennik

Available lengths: 1000 mm, 2000 mm, 3000 mm, 4000 mm.
The standard profile length tolerance is +20 mm. More details >> 1.08.
Dostępne długości: 1000 mm, 2000 mm, 3000 mm, 4000 mm.
Standardowa tolerancja długości profili wynosi: +20 mm. Więcej informacji >> 1.08.



2020 LED PROFILES

PROFILE LED

BIG PROFILES / DUŽE PROFILE

BIG PROFILES / DUŻE PROFILE



PHIL53

PHIL53 profile / profil PHIL53

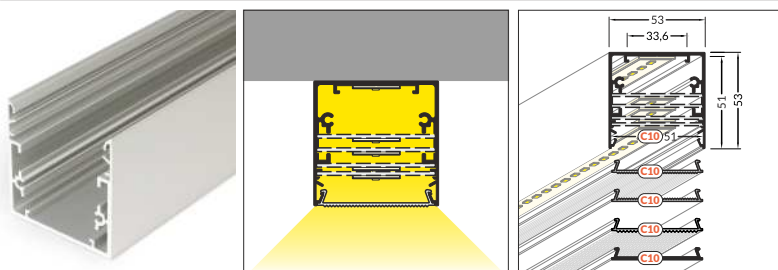

PHIL53 ending / zaślepka PHIL53
material: ABS / materiał: ABS

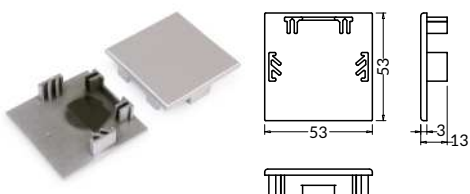

white	anodized	black painted	raw
biały	anodowany	czarny malowany	surowy
63530001	63530020	63530002	63530000

INDEX = 1 pc, length 2000 mm, package > check the pricelist
INDEX = 1 szt., długość 2000 mm, opakowanie > patrz cennik

Available lengths: 1000 mm, 2000 mm, 3000 mm, 4000 mm. The standard profile length tolerance is +20 mm. More details >> 1.08.
Dostępne długości: 1000 mm, 2000 mm, 3000 mm, 4000 mm. Standardowa tolerancja długości profili wynosi: +20 mm. Więcej informacji >> 1.08.

white	silver	black	grey
biały	srebrny	czarny	szary
63640001	63640040	63640002	63640022

INDEX = 1 set = 2 pcs, package > check the pricelist
INDEKS = 1 kpl = 2 szt., opakowanie > patrz cennik



PHIL RECESSED / WPUST

PHIL RECESSED profile / profil PHIL WPUST

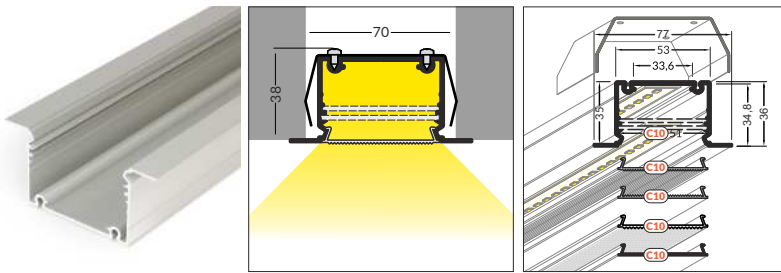

white	anodized	black painted	raw
biały	anodowany	czarny malowany	surowy
97100001	97100020	97100002	97100000

INDEX = 1 pc, length 2000 mm, package > check the pricelist
INDEX = 1 szt., długość 2000 mm, opakowanie > patrz cennik

Available lengths: 1000 mm, 2000 mm, 3000 mm, 4000 mm. The standard profile length tolerance is +20 mm. More details >> 1.08.
Dostępne długości: 1000 mm, 2000 mm, 3000 mm, 4000 mm. Standardowa tolerancja długości profili wynosi: +20 mm. Więcej informacji >> 1.08.

PHIL RECESSED ending / zaślepka PHIL WPUST
material: ABS / materiał: ABS

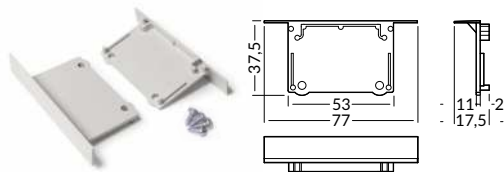

white	silver	black	grey
biały	srebrny	czarny	szary
97990001S	97990040S	97990002S	97990022S

INDEX = 1 set = 2 pcs, package > check the pricelist
INDEKS = 1 kpl = 2 szt., opakowanie > patrz cennik

PHIL RECESSED metal ending / zaślepka PHIL WPUST metal
material: steel / materiał: stal

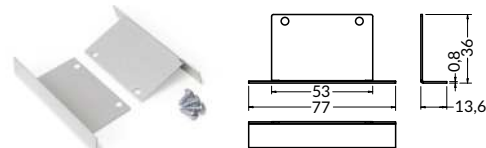

white	silver	black
biały	srebrny	czarny
97120001	97120022	97120002

INDEX = 1 set = 2 pcs, package > check the pricelist
INDEKS = 1 kpl = 2 szt., opakowanie > patrz cennik

PHIL RECESSED holder / uchwyt PHIL WPUST
material: stainless steel / materiał: stal nierdzewna

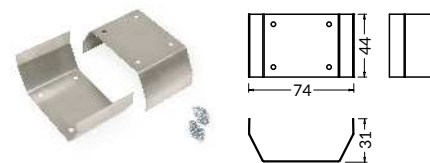

inox
inox
97510019

INDEX = 1 set = 2 pcs, package > check the pricelist
INDEKS = 1 kpl = 2 szt., opakowanie > patrz cennik

LOWI

LOWI profile / profil LOWI

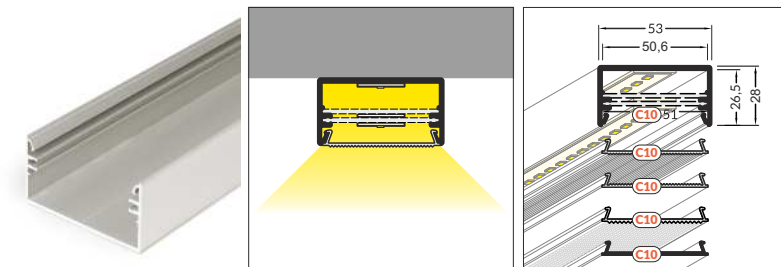

white	anodized	black painted	raw
biały	anodowany	czarny malowany	surowy
93030001	93030020	93030002	93030000

INDEX = 1 pc, length 2000 mm, package > check the pricelist
INDEX = 1 szt., długość 2000 mm, opakowanie > patrz cennik

Available lengths: 1000 mm, 2000 mm, 3000 mm, 4000 mm. The standard profile length tolerance is +20 mm. More details >> 1.08.
Dostępne długości: 1000 mm, 2000 mm, 3000 mm, 4000 mm. Standardowa tolerancja długości profili wynosi: +20 mm. Więcej informacji >> 1.08.

LOWI ending / zaślepka LOWI
material: ABS / materiał: ABS

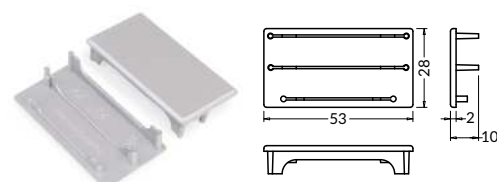

white	silver	black	grey
biały	srebrny	czarny	szary
93066001	93070040	93070002	93070022

INDEX = 1 set = 2 pcs, package > check the pricelist
INDEKS = 1 kpl = 2 szt., opakowanie > patrz cennik



C10 cover / klosz C10

C10 NARROW cover
material: polycarbonate
klosz C10 NARROW
materiał: poliwęglan

C10 WIDE cover
material: polycarbonate
klosz C10 WIDE
materiał: poliwęglan

C10 OPAL cover
material: PMMA
klosz C10 OPAL
materiał: PMMA

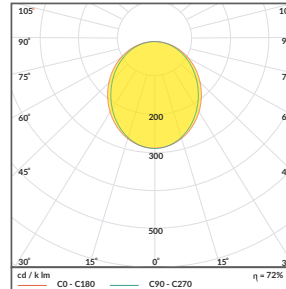
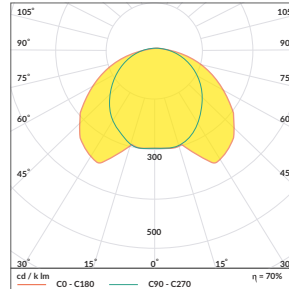
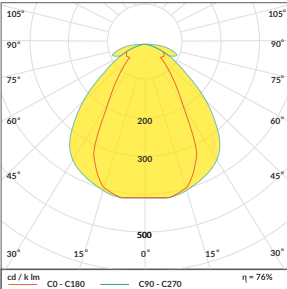
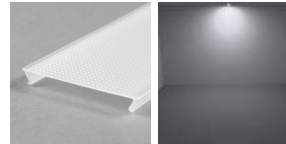
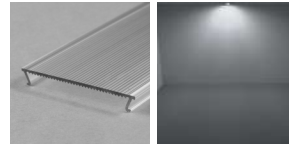
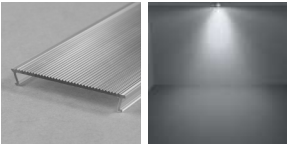
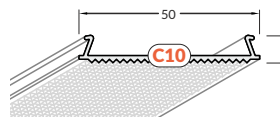
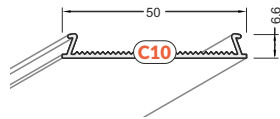
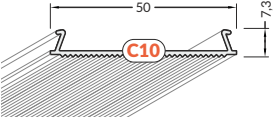

Comparison of variations in the light curves measured on different C10 covers
Porównanie krzywych światłości przy zastosowaniu różnych kloszy C10

NARROW	WIDE	OPAL
63620000	63590000	63690038

INDEX = 1 pc, length 2000 mm
package > check the pricelist
INDEX = 1 szt., długość 2000 mm
opakowanie > patrz cennik

The standard cover length tolerance is +20 mm.
More details >> 1.08.
Standardowa tolerancja długości kloszy wynosi: +20 mm.
Więcej informacji >> 1.08.

C10 aluminium cover / osłona aluminiowa C10

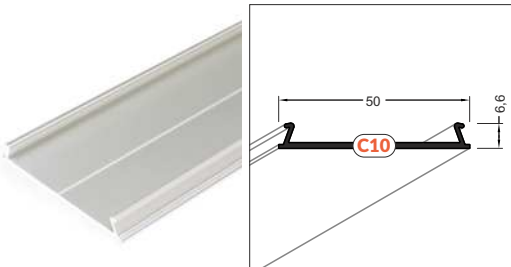

white	anodized	black painted	raw
biały	anodowany	czarny malowany	surowy
63560001	63560020	63560002	63560000

INDEX = 1 pc, length 2000 mm, package > check the pricelist
INDEX = 1 szt., długość 2000 mm, opakowanie > patrz cennik

Available lengths: 1000 mm, 2000 mm, 3000 mm, 4000 mm. The standard profile length tolerance is +20 mm. More details >> 1.08.
Dostępne długości: 1000 mm, 2000 mm, 3000 mm, 4000 mm. Standardowa tolerancja długości profili wynosi: +20 mm. Więcej informacji >> 1.08.

LED mounting / mocowanie LED

LED mounting 50 / mocowanie LED 50
material: aluminium / materiał: aluminium

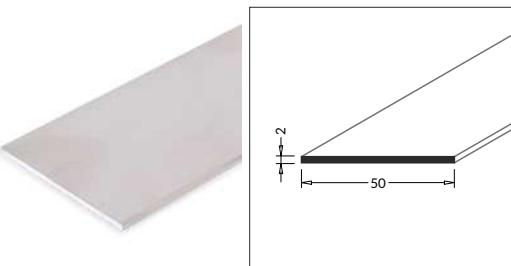

raw
surowy
25090000

INDEX = 1 pc, length 2000 mm, package > check the pricelist
INDEX = 1 szt., długość 2000 mm, opakowanie > patrz cennik

Available lengths: 1000 mm, 2000 mm, 3000 mm, 4000 mm. The standard profile length tolerance is +20 mm. More details >> 1.08.
Dostępne długości: 1000 mm, 2000 mm, 3000 mm, 4000 mm. Standardowa tolerancja długości profili wynosi: +20 mm. Więcej informacji >> 1.08.

Dimensions to install light source / Wymiary przestrzeni do zamontowania źródła światła

PHIL53

C10 NARROW cover
klosz C10 NARROW

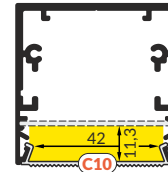
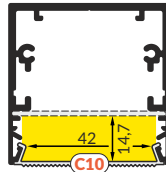
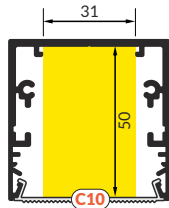

C10 OPAL cover
klosz C10 OPAL



C10 aluminium cover
ostona aluminiowa C10



C10 WIDE cover
klosz C10 WIDE

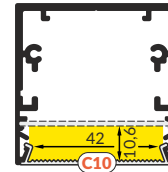
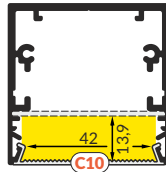
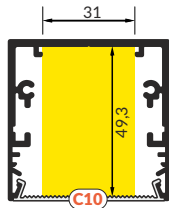

PHIL RECESSED / WPUST

C10 NARROW cover
klosz C10 NARROW

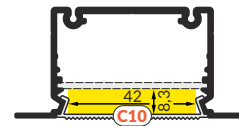
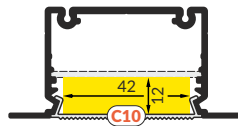
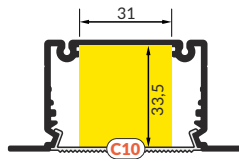

C10 OPAL cover
klosz C10 OPAL



C10 aluminium cover
ostona aluminiowa C10



C10 WIDE cover
klosz C10 WIDE

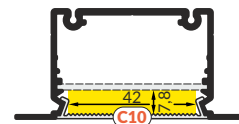
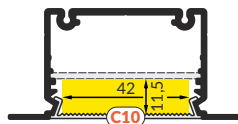
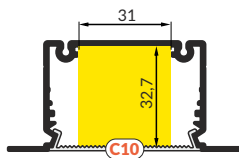

LOWI

C10 NARROW cover
klosz C10 NARROW

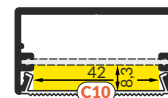
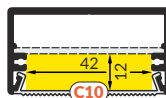
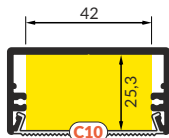

C10 OPAL cover
klosz C10 OPAL



C10 aluminium cover
ostona aluminiowa C10



C10 WIDE cover
klosz C10 WIDE

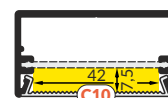
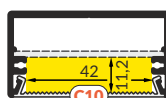
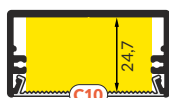



2020 LED PROFILES

PROFILE LED

LED ACCESSORIES / AKCESORIA LED



HIGH QUALITY LIGHT FOR THE MOST DEMANDING APPLICATIONS

WYSOKA JAKOŚĆ ŚWIATŁA DO NAJBARDZIEJ WYMAGAJĄCYCH ZASTOSOWAŃ

NEW

3
SDCM111-150
lm/W

50.000 h

durability
trwałość5
yearswarranty
gwarancja

CE

- even illuminating thanks to stabilisation of the voltage along the entire length of the strip
- a unique Premium White version is available for brilliantly reproduced, saturated colours
- high luminous flux values, can also be used as primary lighting
- ideal solution for lighting shops and exhibitions
- available in 5 and 50 metre reels
- high-quality adhesive backing tape for adhesive bonding

- równomierne świecenie dzięki stabilizacji napięcia na całej długości taśmy
- dostępna unikalna wersja Premium White dla doskonale odwzorowanych, nasyconych kolorów
- wysokie wartości strumienia świetlnego, do zastosowania również jako oświetlenie główne
- idealne rozwiązanie do oświetlania sklepów i ekspozycji
- dostępne rolki 5 i 50 metrów
- wysokiej klasy taśma podkładowa do przyklejania



Comparison of lighting effects with standard light sources (left) and Premium White light sources (right)

Porównanie efektu oświetlenia z wykorzystaniem standardowych źródeł światła (po lewej) oraz źródeł Premium White (po prawej)

Ra>90

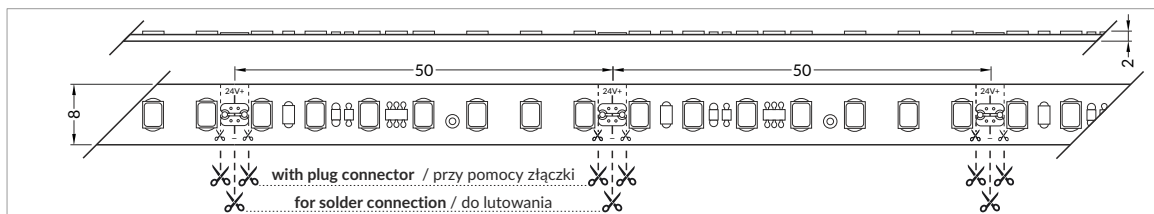

Ra>80

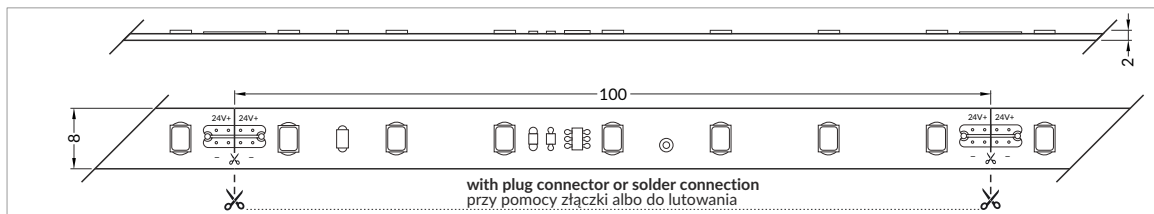

2500
lm/m

	voltage	P/m	luminous flux	colour	reel length	standard	power	index
	napięcie	P/m	strumień	barwa	długość rolki	standard	moc	indeks
PHILIPS Fortimo LEDFlex	24V	140 P/m	2500 lm/m	927	5 m	(P)	22,5 W/m	B4995800
PHILIPS Fortimo LEDFlex	24V	140 P/m	2500 lm/m	930PW	5 m	(P)	21,2 W/m	B4995600
PHILIPS Fortimo LEDFlex	24V	140 P/m	2500 lm/m	940PW	5 m	(P)	20 W/m	B4995700
PHILIPS Fortimo LEDFlex	24V	140 P/m	2500 lm/m	965	5 m	(P)	20 W/m	B4995900
PHILIPS Fortimo LEDFlex	24V	70 P/m	2500 lm/m	830	5 m	(P)	18,9 W/m	B4996000
PHILIPS Fortimo LEDFlex	24V	70 P/m	2500 lm/m	830	50 m	(P)	18,9 W/m	B4996200
PHILIPS Fortimo LEDFlex	24V	70 P/m	2500 lm/m	840	5 m	(P)	17,6 W/m	B4996100
PHILIPS Fortimo LEDFlex	24V	70 P/m	2500 lm/m	840	50 m	(P)	17,6 W/m	B4996300

MOQ = 1 reel / minimalna ilość zamówienia = 1 rolka

2000
lm/m

	voltage	P/m	luminous flux	colour	reel length	standard	power	index
	napięcie	P/m	strumień	barwa	długość rolki	standard	moc	indeks
PHILIPS Fortimo LEDFlex	24V	140 P/m	2000 lm/m	927	5 m	(P)	18 W/m	B4996600
PHILIPS Fortimo LEDFlex	24V	140 P/m	2000 lm/m	930PW	5 m	(P)	17,1 W/m	B4996400
PHILIPS Fortimo LEDFlex	24V	140 P/m	2000 lm/m	930PW	50 m	(P)	17,1 W/m	B4997200
PHILIPS Fortimo LEDFlex	24V	140 P/m	2000 lm/m	940PW	5 m	(P)	16 W/m	B4996500
PHILIPS Fortimo LEDFlex	24V	140 P/m	2000 lm/m	940PW	50 m	(P)	16 W/m	B4997300
PHILIPS Fortimo LEDFlex	24V	140 P/m	2000 lm/m	965	5 m	(P)	16 W/m	B4996700
PHILIPS Fortimo LEDFlex	24V	70 P/m	2000 lm/m	827	5 m	(P)	15,6 W/m	B4996800
PHILIPS Fortimo LEDFlex	24V	70 P/m	2000 lm/m	830	5 m	(P)	14,9 W/m	B4996900
PHILIPS Fortimo LEDFlex	24V	70 P/m	2000 lm/m	830	50 m	(P)	14,9 W/m	B4997400
PHILIPS Fortimo LEDFlex	24V	70 P/m	2000 lm/m	840	5 m	(P)	13,8 W/m	B4997000
PHILIPS Fortimo LEDFlex	24V	70 P/m	2000 lm/m	840	50 m	(P)	13,8 W/m	B4997500
PHILIPS Fortimo LEDFlex	24V	70 P/m	2000 lm/m	865	5 m	(P)	13,8 W/m	B4997100

MOQ = 1 reel / minimalna ilość zamówienia = 1 rolka

1500
lm/m

	voltage	P/m	luminous flux	colour	reel length	standard	power	index
	napięcie	P/m	strumień	barwa	długość rolki	standard	moc	indeks
PHILIPS Fortimo LEDFlex	24V	140 P/m	1500 lm/m	927	5 m	(P)	13,2 W/m	B4997800
PHILIPS Fortimo LEDFlex	24V	140 P/m	1500 lm/m	930PW	5 m	(P)	12,6 W/m	B4997600
PHILIPS Fortimo LEDFlex	24V	140 P/m	1500 lm/m	930PW	50 m	(P)	12,6 W/m	B4998400
PHILIPS Fortimo LEDFlex	24V	140 P/m	1500 lm/m	940PW	5 m	(P)	11,8 W/m	B4997700
PHILIPS Fortimo LEDFlex	24V	140 P/m	1500 lm/m	940PW	50 m	(P)	11,8 W/m	B4998500
PHILIPS Fortimo LEDFlex	24V	140 P/m	1500 lm/m	965	5 m	(P)	11,8 W/m	B4997900
PHILIPS Fortimo LEDFlex	24V	70 P/m	1500 lm/m	827	5 m	(P)	11,2 W/m	B4997800
PHILIPS Fortimo LEDFlex	24V	70 P/m	1500 lm/m	830	5 m	(P)	10,9 W/m	B4998100
PHILIPS Fortimo LEDFlex	24V	70 P/m	1500 lm/m	830	50 m	(P)	10,9 W/m	B4998600
PHILIPS Fortimo LEDFlex	24V	70 P/m	1500 lm/m	840	5 m	(P)	10 W/m	B4998200
PHILIPS Fortimo LEDFlex	24V	70 P/m	1500 lm/m	840	50 m	(P)	10 W/m	B4998700
PHILIPS Fortimo LEDFlex	24V	70 P/m	1500 lm/m	865	5 m	(P)	10 W/m	B4998300

MOQ = 1 reel / minimalna ilość zamówienia = 1 rolka

1000
lm/m

	voltage	P/m	luminous flux	colour	reel length	standard	power	index
	napięcie	P/m	strumień	barwa	długość rolki	standard	moc	indeks
PHILIPS Fortimo LEDFlex	24V	140 P/m	1000 lm/m	927	5 m	(P)	8,6 W/m	B4999400
PHILIPS Fortimo LEDFlex	24V	140 P/m	1000 lm/m	930PW	5 m	(P)	8,2 W/m	B4998800
PHILIPS Fortimo LEDFlex	24V	140 P/m	1000 lm/m	930PW	50 m	(P)	8,2 W/m	B4999600
PHILIPS Fortimo LEDFlex	24V	140 P/m	1000 lm/m	940PW	5 m	(P)	7,6 W/m	B4998900
PHILIPS Fortimo LEDFlex	24V	140 P/m	1000 lm/m	940PW	50 m	(P)	7,6 W/m	B4999700
PHILIPS Fortimo LEDFlex	24V	140 P/m	1000 lm/m	965	5 m	(P)	7,6 W/m	B4999500
PHILIPS Fortimo LEDFlex	24V	70 P/m	1000 lm/m	827	5 m	(P)	7,4 W/m	B4999000
PHILIPS Fortimo LEDFlex	24V	70 P/m	1000 lm/m	830	5 m	(P)	7,1 W/m	B4999100
PHILIPS Fortimo LEDFlex	24V	70 P/m	1000 lm/m	830	50 m	(P)	7,1 W/m	B4999800
PHILIPS Fortimo LEDFlex	24V	70 P/m	1000 lm/m	840	5 m	(P)	6,6 W/m	B4999200
PHILIPS Fortimo LEDFlex	24V	70 P/m	1000 lm/m	840	50 m	(P)	6,6 W/m	B4999900
PHILIPS Fortimo LEDFlex	24V	70 P/m	1000 lm/m	865	5 m	(P)	6,6 W/m	B4999300

MOQ = 1 reel / minimalna ilość zamówienia = 1 rolka

PROFESSIONAL LIGHTING PARAMETERS

PROFESJONALNE PARAMETRY OŚWIETLENIOWE

Ra>80

4
SDCM≤115
lm/W

20.000 h

durability
trwałośćwarranty
gwarancja

CE

RoHS

240
P/m

The 240 P/m thick strip allows a continuous line of light to be achieved even in combination with the shallow GROOVE10 LED profile.

Gęsta taśma 240 pkt./m umożliwia osiągnięcie ciągłej linii światła nawet w połączeniu z płytkim profilem LED GROOVE10.

Luminent FLEX 900

8,5 W/m
880 lm/m
104 lm/W

8,5
W/m

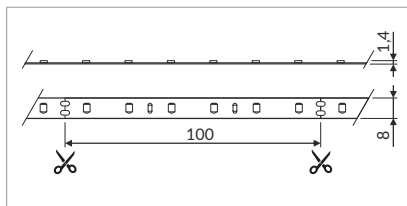

voltage	P/m	IP	colour	standard	index
napięcie	P/m	IP	barwa	standard	indeks

OSRAM LMNT-FX 900	24V	60 P/m	-	827 (P)	B4000100
OSRAM LMNT-FX 900	24V	60 P/m	-	830 (P)	B4000200
OSRAM LMNT-FX 900	24V	60 P/m	-	840 (P)	B4000300

MOQ = 1 reel = 5 m / minimalna ilość zamówienia = 1 rolka = 5 m

Luminent FLEX 1400

12 W/m
1380 lm/m
115 lm/W

115
lm/W

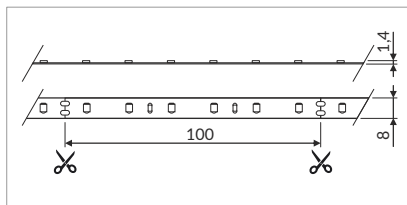

voltage	P/m	IP	colour	standard	index
napięcie	P/m	IP	barwa	standard	indeks

OSRAM LMNT-FX 1400	24V	70 P/m	-	827 (P)	B4000400
OSRAM LMNT-FX 1400	24V	70 P/m	-	830 (P)	B4000500
OSRAM LMNT-FX 1400	24V	70 P/m	-	840 (P)	B4000600

MOQ = 1 reel = 5 m / minimalna ilość zamówienia = 1 rolka = 5 m

Luminent FLEX 1000 Special

9,6 W/m
1000 lm/m
104 lm/W

240
P/m

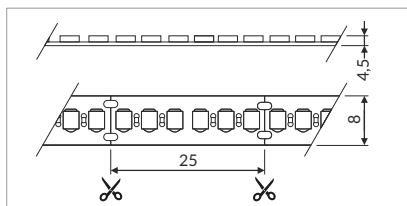

voltage	P/m	IP	colour	standard	index
napięcie	P/m	IP	barwa	standard	indeks

OSRAM LMNT-FX 1000	24V	240 P/m	-	830 (P)	B4000700
OSRAM LMNT-FX 1000	24V	240 P/m	-	840 (P)	B4000800

MOQ = 1 reel = 5 m / minimalna ilość zamówienia = 1 rolka = 5 m

Luminent FLEX 900 Protected

8,5 W/m
880 lm/m
104 lm/W

IP65

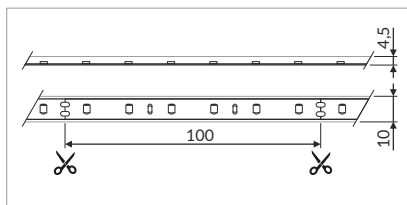

voltage	P/m	IP	colour	standard	index
napięcie	P/m	IP	barwa	standard	indeks

OSRAM LMNT-FX 900	24V	60 P/m	IP65	830 (P)	B4000900
OSRAM LMNT-FX 900	24V	60 P/m	IP65	840 (P)	B4001000

MOQ = 1 reel = 5 m / minimalna ilość zamówienia = 1 rolka = 5 m

Luminent FLEX 1400 Protected

12,5 W/m
1380 lm/m
110 lm/W

IP65

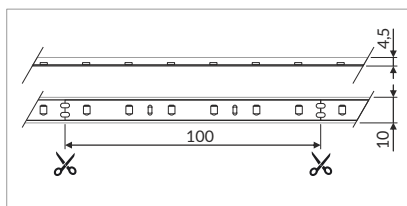

voltage	P/m	IP	colour	standard	index
napięcie	P/m	IP	barwa	standard	indeks

OSRAM LMNT-FX 1400	24V	70 P/m	IP65	830 (P)	B4001100
OSRAM LMNT-FX 1400	24V	70 P/m	IP65	840 (P)	B4001200

MOQ = 1 reel = 5 m / minimalna ilość zamówienia = 1 rolka = 5 m

High-quality LED chips, adapted to TOPMET LED profiles / Wysokiej jakości diody, dopasowanie do profili LED TOPMET



LG Innotech LED chips
diody LED LG Innotech

Ra>80

3
SDCM

138
lm/W

5
years

warranty
gwarancja

LED module LG 20 / Moduł LED LG 20

14,4 W

Fits to profiles: / Pasuje do profili:

- LINEA20 >> 02.29
- LINEA-IN20 >> 03.37
- LINEA-IN20 TRIMLESS >> 03.45
- VARIO30 >> 07.06, 07.14
- PHIL53 >> 08.01
- PHIL RECESSED / WPUST >> 08.02
- LOWI >> 08.02

	voltage napięcie	lumen output strumień świetlny	colour barwa	index indeks
LED module / moduł LED LG 20	24V	2000 lm	830	85670000
LED module / moduł LED LG 20	24V	2000 lm	840	85680000

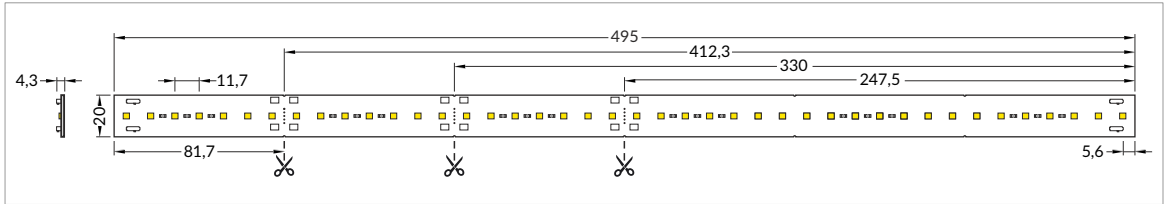

LED module LG 30 / Moduł LED LG 30

14,5 W

Fits to profiles: / Pasuje do profili:

- VARIO30 >> 07.06, 07.14
- PHIL53 >> 08.01
- PHIL RECESSED / WPUST >> 08.02
- LOWI >> 08.02

	voltage napięcie	lumen output strumień świetlny	colour barwa	index indeks
LED module / moduł LED LG 30	24V	2000 lm	830	85650000
LED module / moduł LED LG 30	24V	2000 lm	840	85660000

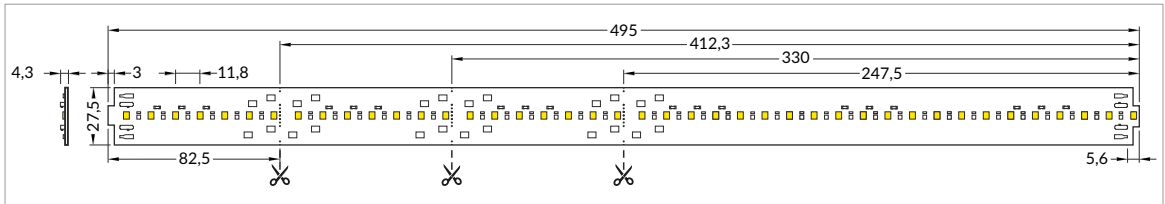

LED module LG 50 / Moduł LED LG 50

19,2 W

Fits to profiles: / Pasuje do profili:

- PHIL53 >> 08.01
- PHIL RECESSED / WPUST >> 08.02
- LOWI >> 08.02

	voltage napięcie	lumen output strumień świetlny	colour barwa	index indeks
LED module / moduł LED LG 50	24V	2650 lm	830	85630000
LED module / moduł LED LG 50	24V	2650 lm	840	85640000

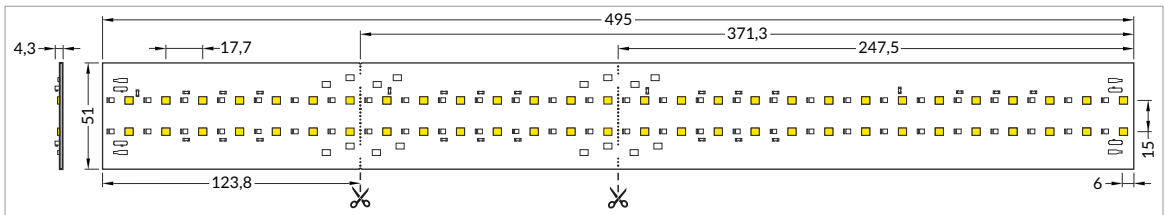

accessories / akcesoria



WAGO connecting element for LED modules
element łączący WAGO do modułów LED

pitch 6 mm; 2-pole; length 30 mm
raster 6 mm; 2-bieg.; długość 30 mm

85690000



operating tool WAGO
przyrząd montażowy WAGO

85700000

Do you need a different colour of light?

On special request we may also prepare light sources with the colour of 820, 860 or other specified by the customer. Ask our sales representative for details.

Potrzebujesz inną barwę światła?

Na specjalne zamówienie możemy przygotować również źródła o barwie 820, 860 lub innej wskazanej przez klienta. O szczegóły zapytaj naszego przedstawiciela handlowego.

TOPMET PREMIUM LED modules (P) / moduły LED TOPMET z serii PREMIUM (P)

50.000 h durability / trwałość 50.000 h

69x10 mm

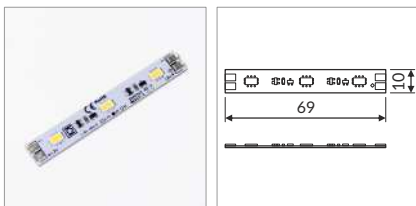
1,5 W
146 lm (827)
148 lm (830)
155 lm (840)

dimensions	voltage	P/module	colour	index
wymiary	napięcie	P/moduł	barwa	indeks
69x10 mm	12 V	3 LED	827	85600300
69x10 mm	12 V	3 LED	830	85610300
69x10 mm	12 V	3 LED	840	85620300

fi30 mm

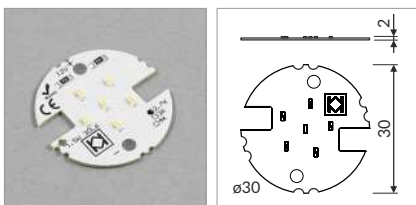
1,5 W
106 lm (827)
110 lm (830)
115 lm (840)

dimensions	voltage	P/module	colour	index
wymiary	napięcie	P/moduł	barwa	indeks
fi30 mm	12 V	6 LED	827	85414072
fi30 mm	12 V	6 LED	830	85414074
fi30 mm	12 V	6 LED	840	85414073

STANDARD LED strips (S) / taśmy LED z serii STANDARD (S)

60 P/m

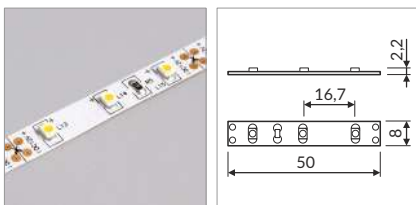
3528
6-7 lm/LED
4,8 W/m
360 lm/m ± 10%

voltage	P/m	colour	IP	standard	index
napięcie	P/m	barwa	IP	standard	indeks
12V	60 P/m	828-832	-	(S)	B4200000
12V	60 P/m	840-845	-	(S)	B4210000

MOQ = 1 reel = 5 m / minimalna ilość zamówienia = 1 rolka = 5 m

120 P/m

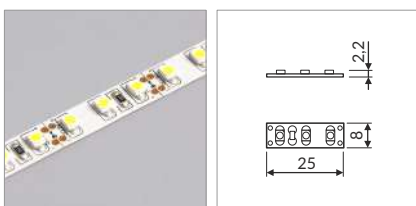
3528
6-7 lm/LED
9,6 W/m
720 lm/m ± 10%

voltage	P/m	colour	IP	standard	index
napięcie	P/m	barwa	IP	standard	indeks
12V	120 P/m	828-832	-	(S)	B4240000
12V	120 P/m	840-845	-	(S)	B4250000

MOQ = 1 reel = 5 m / minimalna ilość zamówienia = 1 rolka = 5 m

BUDGET LED strips (B) / taśmy LED z serii BUDGET (B)

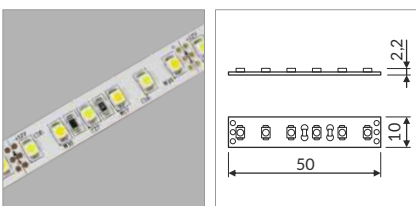
warm-cool
ciepła-zimna
120 P/m3528
9,6 W/m

voltage	P/m	colour	IP	standard	index
napięcie	P/m	barwa	IP	standard	indeks
12V	120 P/m	warm-cool white biała ciepła-zimna	-	(B)	84509900

MOQ = 1 reel = 5 m / minimalna ilość zamówienia = 1 rolka = 5 m

Vario white controlling / sterowanie Vario white >> 9.13

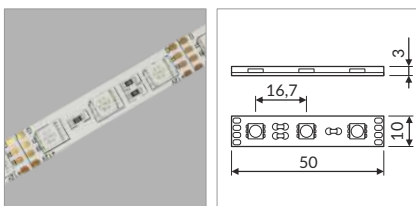
RGB
60 P/m
IP655050
14,4 W/m

voltage	P/m	colour	IP	standard	index
napięcie	P/m	barwa	IP	standard	indeks
12V	120 P/m	RGB	65	(B)	85414077

MOQ = 1 reel = 5 m / minimalna ilość zamówienia = 1 rolka = 5 m

RGB controlling / sterowanie RGB >> 9.14

OSRAM IP66, IP67

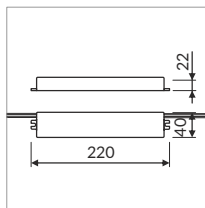
**30 W**24 V / 220-240 V
IP66; OT; P

53500000

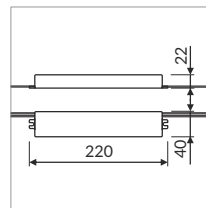
**50 W**24 V / 220-240 V
IP66; OT; P

53510000

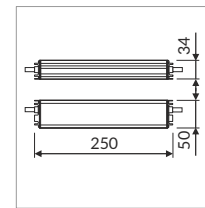
**80 W**24 V / 220-240 V
IP67; OT; P

53520000

OSRAM ELEMENT

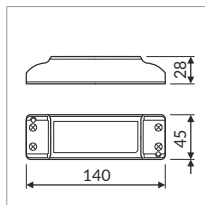
**30 W**

24 V / 220-240 V

99463776

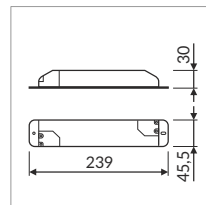
**60 W**

24 V / 220-240 V

99463790

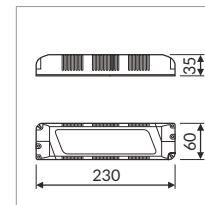
**90 W**

24 V / 220-240 V

99463813

OSRAM LED strips / taśmy LED OSRAM

>> 9.03-9.04

TOPMET fit30

Fit30 power supplies are suitable to profiles: / Zasilacze fit30 pasują do profili:

- VARIO30 >> 07.06 / 07.14
- PHIL53 >> 08.01
- PHIL RECESSED / WPUST >> 08.02
- LOWI >> 08.02

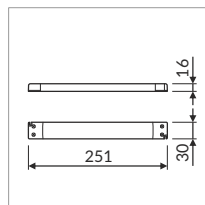
**30 W**

24 V / 200-240 V

15860000

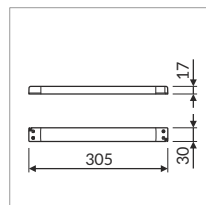
**60 W**

24 V / 200-240 V

15870000

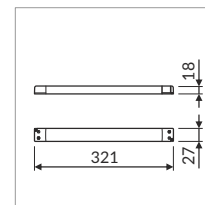
**100 W**

24 V / 100-240 V

15880000

TOPMET

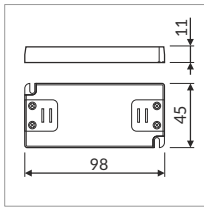

6 W
12 V / 200-240 V

15700000

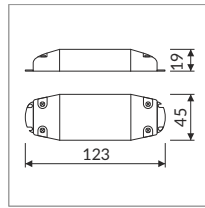

15 W
12 V / 200-240 V

15850000

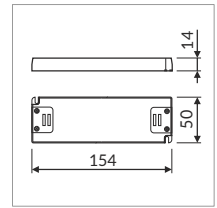
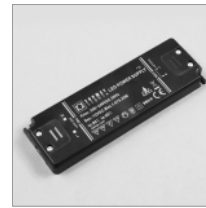

20 W
12 V / 200-240 V

15640000

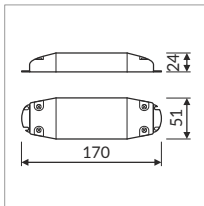

30 W
12 V / 200-240 V

15810000

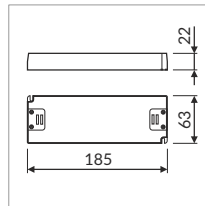

50 W
12 V / 200-240 V

15650000

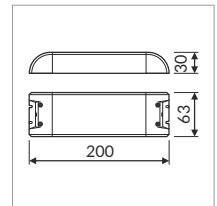

75 W
12 V / 200-240 V

15800000

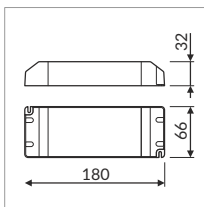

100 W
12 V / 100-240 V

15760000

TOPMET reserves the right to change the appearance of individual power supplies and slightly change the parameters.
Topmet zastrzega sobie prawo do zmiany wyglądu poszczególnych zasilaczy i nieznacznej zmiany parametrów.

others / pozostałe

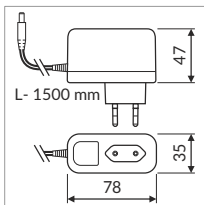

18 W
12 V / 100-240 V
AC adapter / zasilacz wtyczkowy

15820002

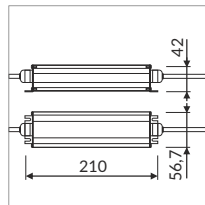

100 W
12 V / 200-240 V
IP68

15710000

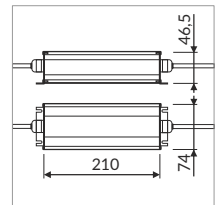

150 W
12 V / 200-240 V
IP68

15720000

48 x 12 x 100

white	anodized	black
biały	anodowany	czarny
67160001	67160020	67160002

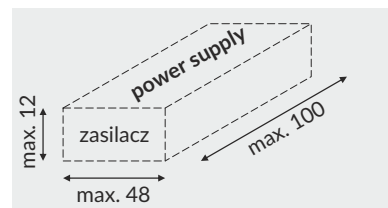
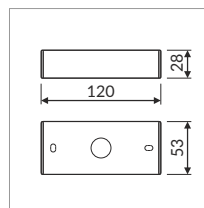

120 x 27 x 216

white	anodized	black
biały	anodowany	czarny
67170001	67170020	67170002

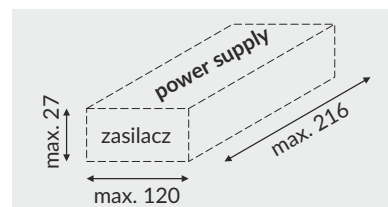
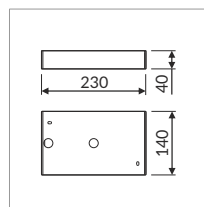

31 x 23 x 286

white	anodized	black
biały	anodowany	czarny
67180001	67180020	67180002

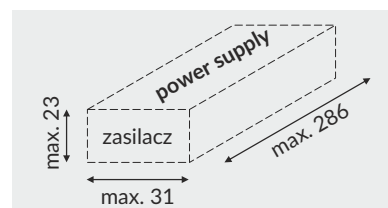
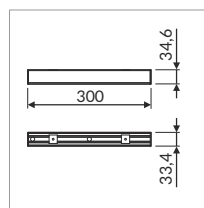
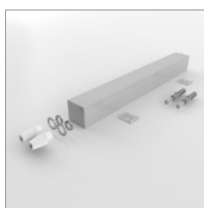

31 x 23 x 386

white	anodized	black
biały	anodowany	czarny
67190001	67190020	67190002

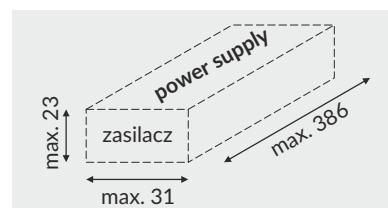
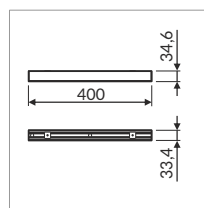
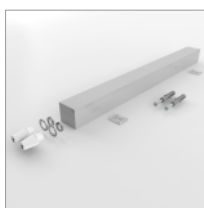

36 x 46 x 474

white	anodized	black
biały	anodowany	czarny
67200001	67200020	67200002

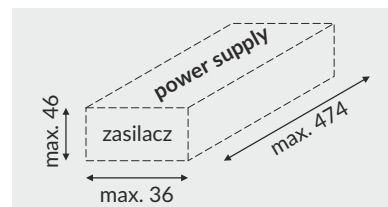
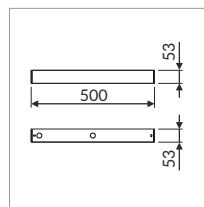
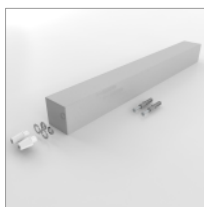



LED switch SU/GR/CO dimmable
włącznik LED SU/GR/CO ściemniający
12-24 V; 60-100 W

53850000



LED switch SU/GR/CO touchless dimmable
włącznik LED SU/GR/CO bezdotykowy ściemniający
12-24 V; 60-100 W

53860000

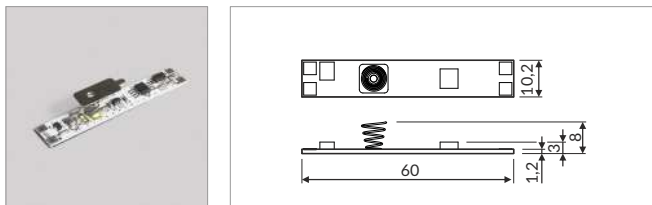

LED switch INSIDE touch dimmable
włącznik LED INSIDE dotykowy ściemniający
12-24 V; 60-100 W

C5010000

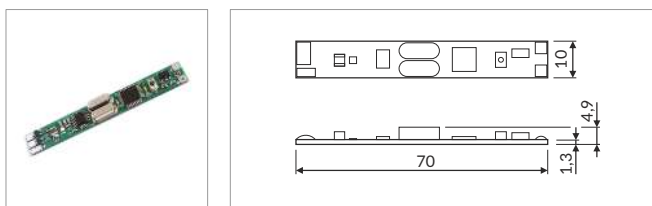
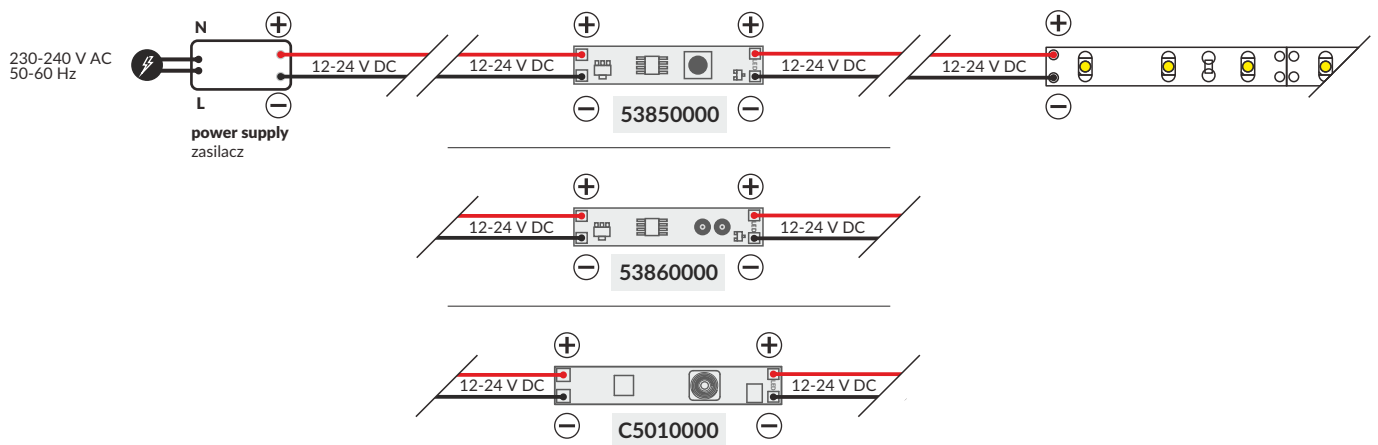

LED receiver basic 1 channel
moduł sterujący LED podstawowy 1-kanalowy
12-24 V; 60-100 W

C5020000



LED remote controller basic 4 channel
pilot sterujący LED podstawowy 4-kanalowy

C5030000

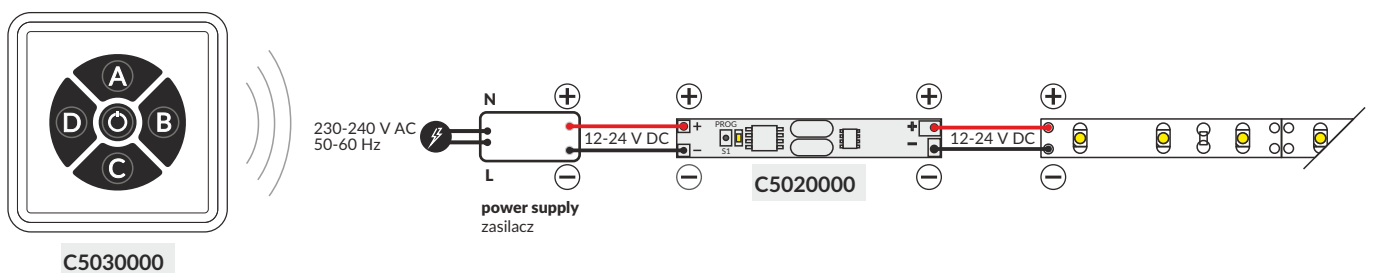

C5030000



LED switch door operated sensor
włącznik LED drzwiowy bezdotkowy
12-24 V; 30 W

15530000

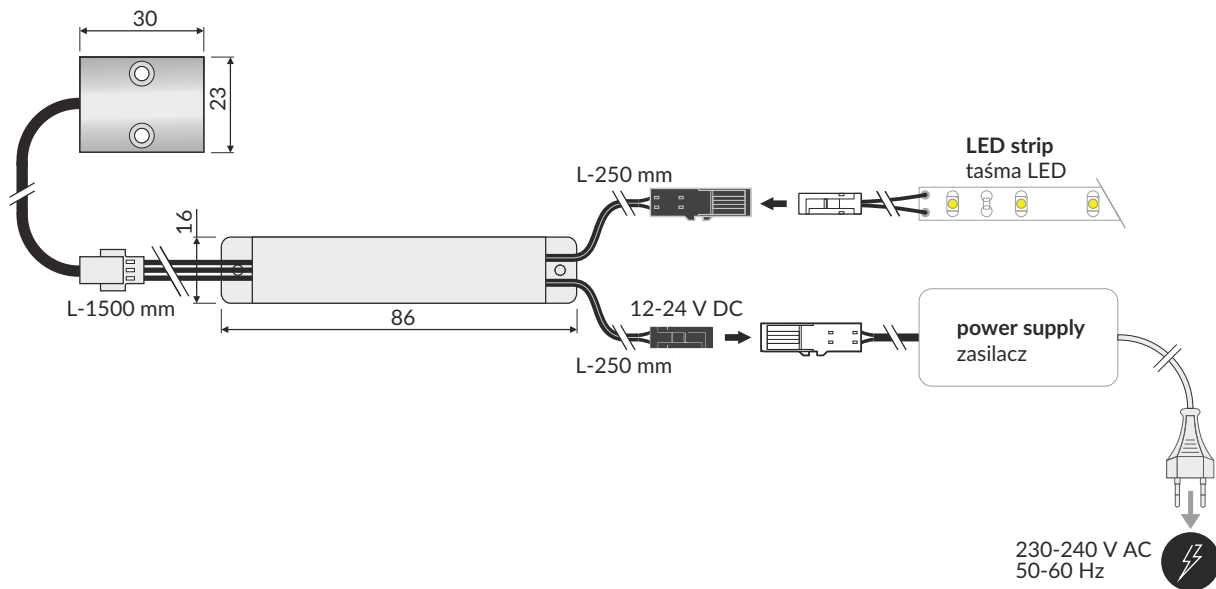
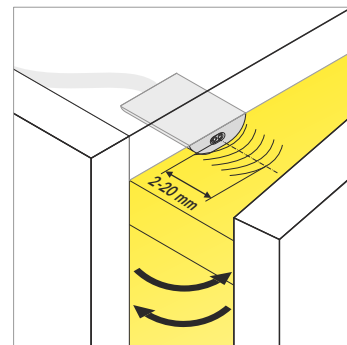

LED switch hand operated sensor
włącznik LED ręczny bezdotkowy
12-24 V; 30 W

15540000

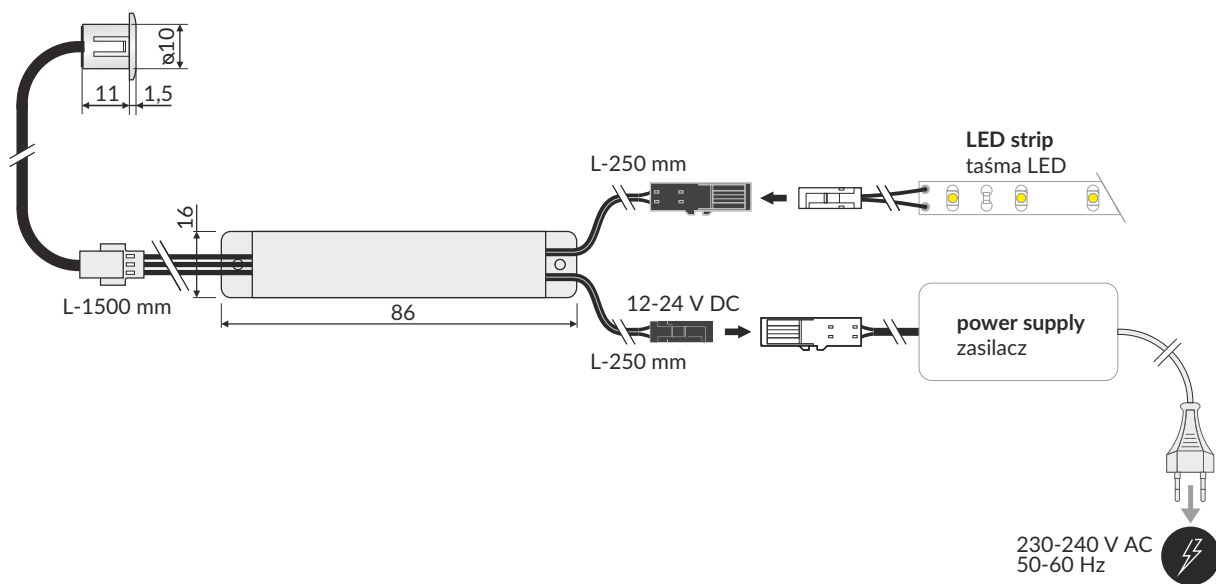
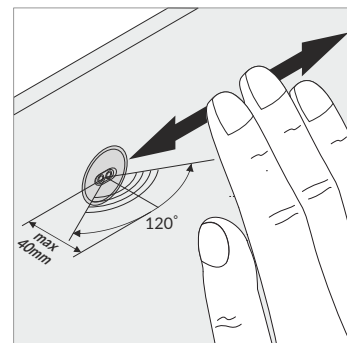



LED switch touch sensor ON/OFF
 włącznik LED dotykowy ON/OFF
 12 V; 30 W

15630000

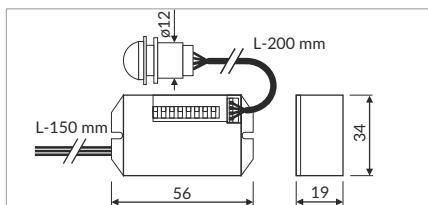
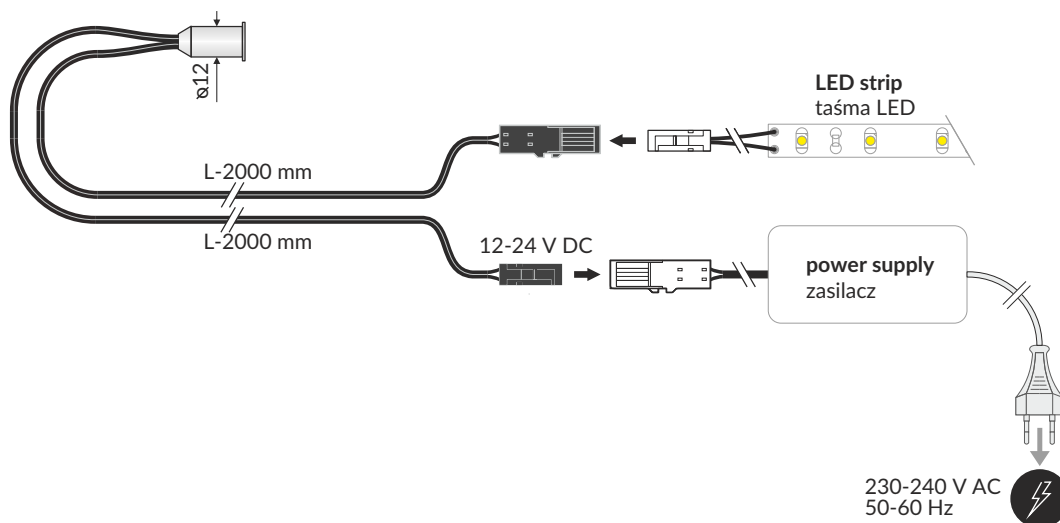
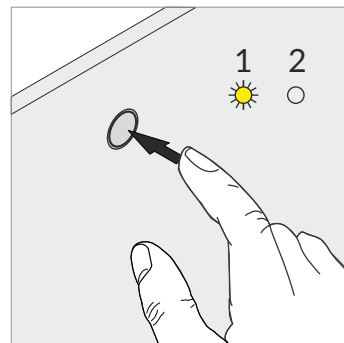

movement sensor YCB1050
 czujnik ruchu YCB1050
 230 V; 800 W

85414061

Vario white lighting system / system oświetlenia Vario white

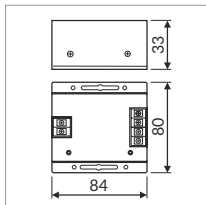

LED receiver warm-cold 2 channel
moduł sterujący LED ciepły-zimny
2-kanalowy
12V/24VDC; 144W/288W

78300000

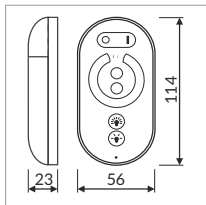

LED remote controller warm-cold
pilot sterujący LED ciepły-zimny

78290000

LED remote controller operates with multiple drivers.
Pilot może obsługiwać kilka sterowników jednocześnie.

TOPMET reserves the right to change the appearance of individual power supplies and slightly change the parameters.

Topmet zastrzega sobie prawo do zmiany wyglądu poszczególnych zasilaczy i nieznacznej zmiany parametrów.

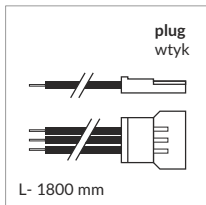

LED cable / przewód LED

3x0,22
1800 mm
1xMIKRO3 plug / 1xWtyk MIKRO3

67030000

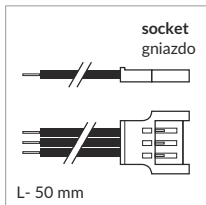
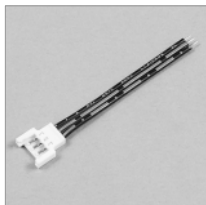

LED cable / przewód LED

3x0,22
50 mm
1xMIKRO3 socket / 1xGniazdo MIKRO3

67020000

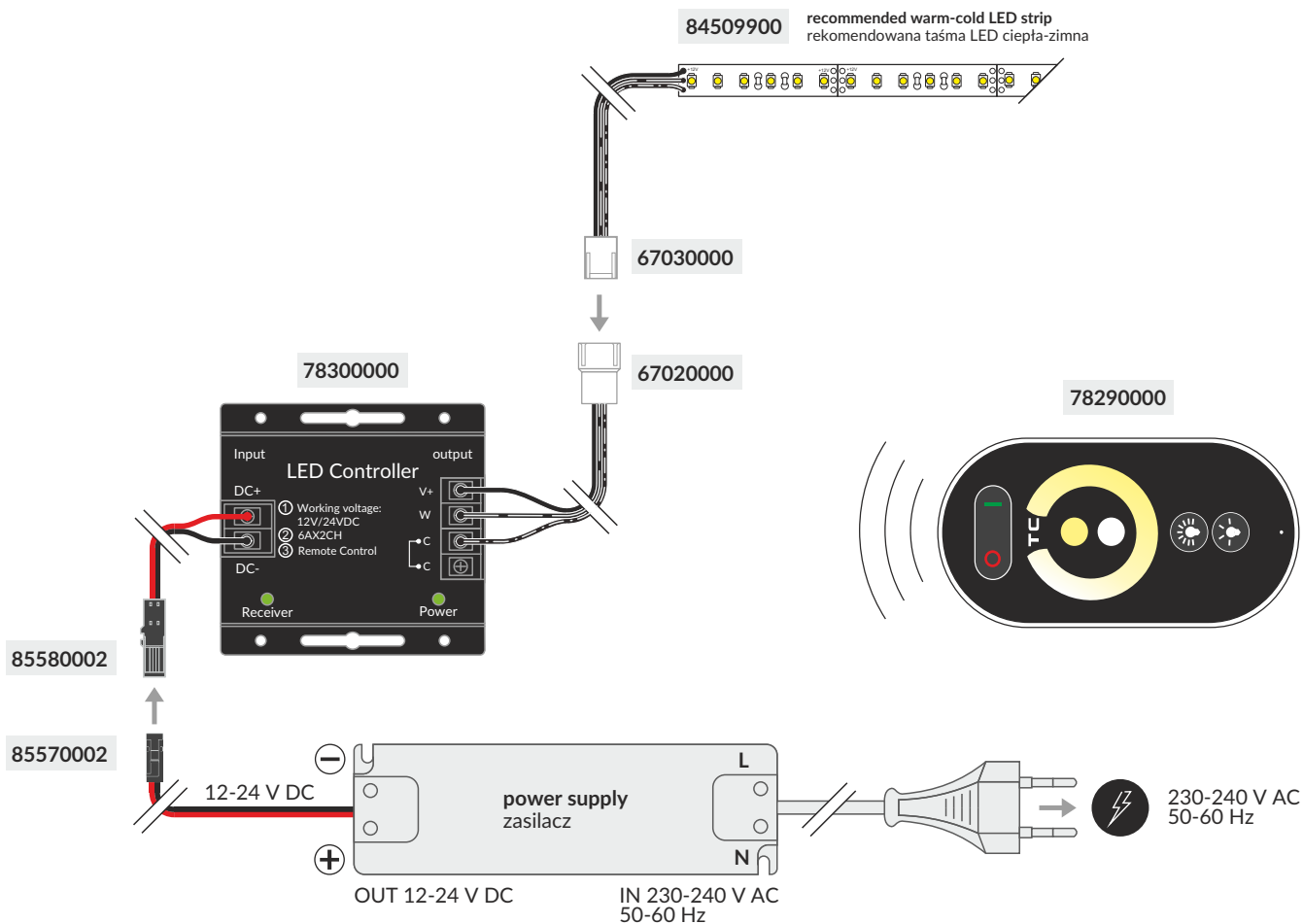

RGB lighting system / system oświetlenia RGB

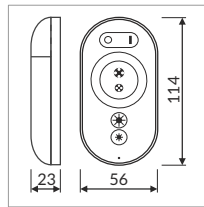
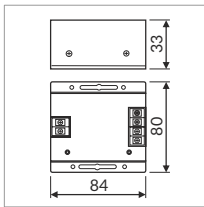

LED RGB remote controller operates with multiple drivers.
Pilot może obsługiwać kilka sterowników jednocześnie.

LED receiver RGB 3 channel
moduł sterujący LED RGB
3-kanalowy
12V/24VDC; 216W/432W

78450000

LED remote controller RGB
pilot sterujący LED RGB

78460000

TOPMET reserves the right to change the appearance of individual power supplies and slightly change the parameters.

Topmet zastrzega sobie prawo do zmiany wyglądu poszczególnych zasilaczy i nieznacznej zmiany parametrów.

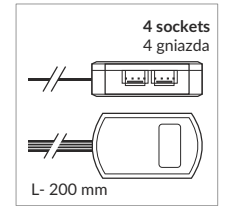
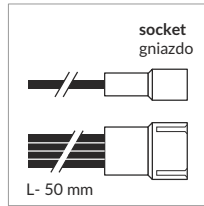
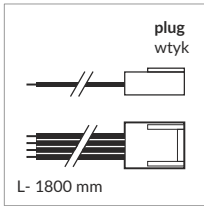

RGB LED cable / przewód LED RGB

4x0,5
1800 mm
1xMIKRO4 plug / 1xWtyk MIKRO4

67060000

RGB LED cable / przewód LED RGB

4x0,5
50 mm
1xMIKRO4 socket / 1xGniazdo MIKRO4

67050000

RGB LED distribution box
rozdzielacz LED zintegrowany RGB

4x0,5
200 mm
4xMIKRO4 socket / 4xGniazdo MIKRO4

67040000

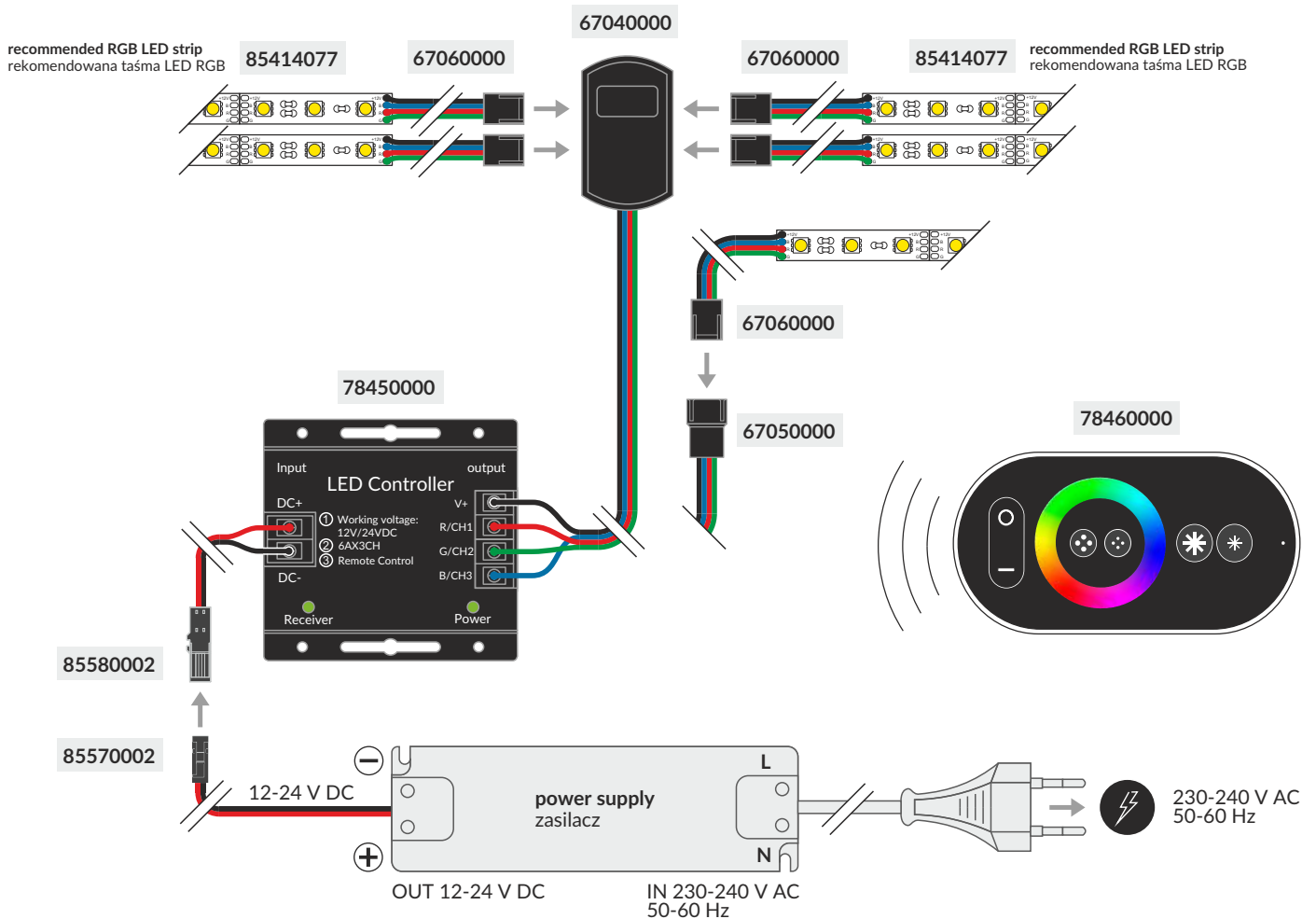

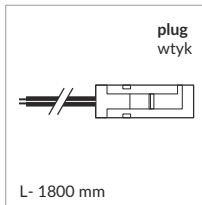

LED cable / przewód LED

2x0,35
1800 mm
1xMINI plug / 1xWtyk MINI
black / czarny

85430002

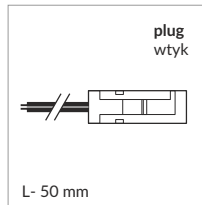

LED cable / przewód LED

2x0,35
50 mm
1xMINI plug / 1xWtyk MINI
black / czarny

85570002

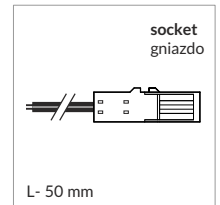

LED cable / przewód LED

2x0,35
50 mm
1xMINI socket / 1xGniazdo MINI
black / czarny

85580002

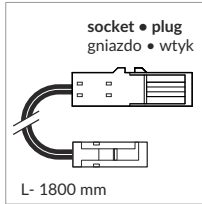

**LED extension cable
przedłużacz LED**

2x0,35
1800 mm
1xMINI socket / 1xGniazdo MINI
1xMINI plug / 1xWtyk MINI
black / czarny

85460002

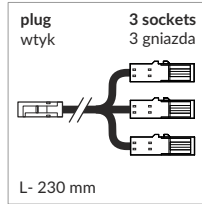

LED cable / rozdzielacz LED

2x0,35
230 mm
3xMINI socket / 3xGniazdo MINI
1xMINI plug / 1xWtyk MINI
black / czarny

85470002

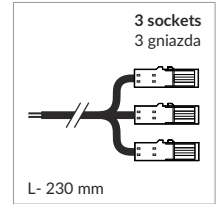

LED cable / rozdzielacz LED

2x0,35
230 mm
3xMINI socket / 3xGniazdo MINI
black / czarny

85590002

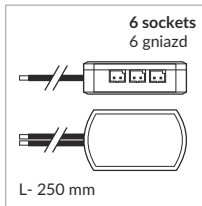

**LED distribution box
rozdzielacz LED zintegrowany**

2x0,5
250 mm
6xMINI socket / 6xGniazdo MINI
black / czarny

85366900

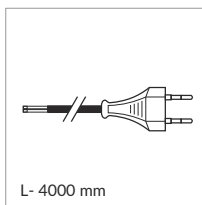

cabl e / przewód

250 V
2x0,75
4000 mm
1xPlug / 1xWtyk
black / czarny
2,5 A

67100002

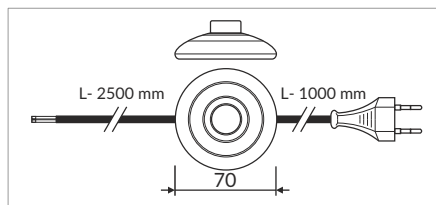

cabl e with footswitch / przewód z włącznikiem nożnym

250 V
2x0,75
1000/2500 mm
1xPlug / 1xWtyk
black / czarny
2,5 A

67110002

LED profile slings / zawiesia od profili LED

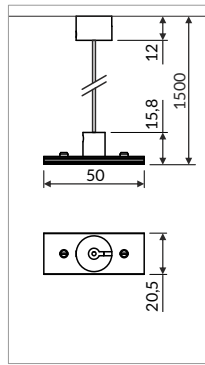

SELV sling
zawiesie SELV
50 V; 1500

white	silver	black
biały	srebrny	czarny
67120001	67120022	67120002

INDEX = 1 set = 2 pcs , package > check the pricelist
INDEKS = 1 kpl = 2 szt., opakowanie > patrz cennik

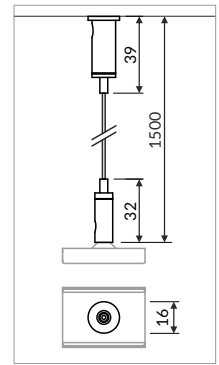

sling for LED mounting
zawiesie do uchwytu LED
1500

chrome
chrom
67140003

INDEX = 1 set = 2 pcs , package > check the pricelist
INDEKS = 1 kpl = 2 szt., opakowanie > patrz cennik

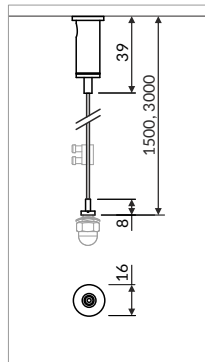

large sling
zawiesie duże

chrome 1500 mm	chrome 3000 mm
chrom 1500 mm	chrom 3000 mm
43100003	43110003

INDEX = 1 set = 2 pcs , package > check the pricelist
INDEKS = 1 kpl = 2 szt., opakowanie > patrz cennik

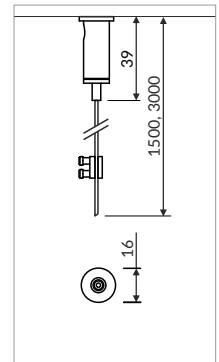

SKB sling
zawiesie SKB

chrome 1500 mm	chrome 3000 mm
chrom 1500 mm	chrom 3000 mm
67160003	67170003

INDEX = 1 set = 1 pc , package > check the pricelist
INDEKS = 1 kpl = 1 szt., opakowanie > patrz cennik

tilted bracket for LED profiles / uchwyt uchylny do profili LED

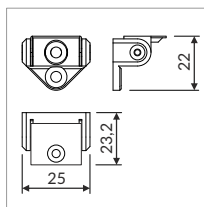

compatible with cone flexible mounting plates:
U4, U6, U, W, Y, Z
mounting plates not included

kompatybilny z uchwytami sprężystymi cone:
U4, U6, U, W, Y, Z
komplet nie zawiera uchwytów

tilted bracket
uchwyt uchylny

white	silver	black	grey
biały	srebrny	czarny	szary
67230001	67230040	67230002	67230022

INDEX = 10 sets = 20 pcs , package > check the pricelist
INDEKS = 10 kpl = 20 szt., opakowanie > patrz cennik

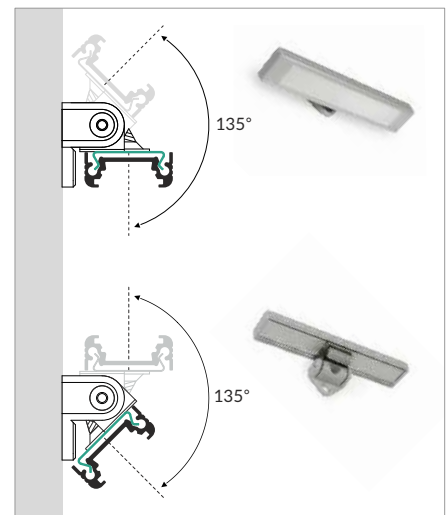

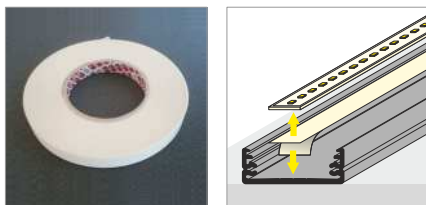

adhesive tape double-sided thermally conductive
taśma dwustronna termoprzewodząca

15 mm x 50 m

67990000

1 reel / 1 rolka

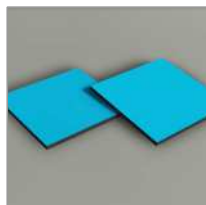

adhesive tape double-sided nonconductive
taśma dwustronna nieprzewodząca

25 x 25 mm

76340000

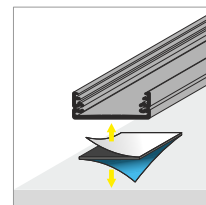
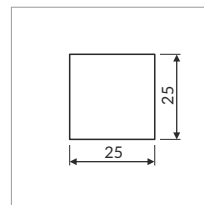

silicone housing for 8 mm LED strip
osłona silikonowa do taśmy LED 8 mm

11 mm x 5 mm x 5 mm

67980000

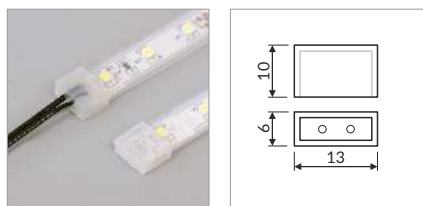

ending for silicone housing for 8 mm LED strip
zaślepka do osłony silikonowej do taśmy LED 8 mm

67970000s

INDEX = 1 set, package > check the pricelist
INDEKS = 1 kpl, opakowanie > patrz cennik



cleaning rubber for anodized surfaces
gumka do czyszczenia powierzchni anodowanych

25250000

2020 LED PROFILES

PROFILE LED

Why LED profiles? / Dlaczego profile LED?

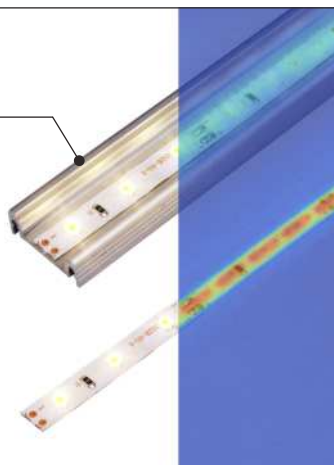
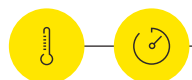

HEAT DISSIPATION

An aluminium profile is a radiator - it dissipates heat from the LED source. Lower temperature means better operating conditions for the diodes, therefore, extension of the LED lifespan and better illumination parameters. It also translates to economic considerations - LED does not require such frequent replacement of light sources. An aluminium profile is an investment, which pays off.



Some LED sources available on the market may exceed radiation capabilities of a given aluminium profile. In order to ensure correct operation, a LED source with appropriate parameters needs to be matched to an aluminium profile.

ODPROWADZANIE CIEPŁA

Profil aluminiowy jest radiatorom - odprowadza ciepło ze źródła LED. Niższa temperatura to lepsze warunki pracy dla diod, a tym samym przedłużenie żywotności LED i lepsze parametry świetlne. Przekłada się to również na względy ekonomiczne - LED nie wymaga tak częstych wymian źródeł światła. Profil aluminiowy to inwestycja, która się opłaca.



Niektóre źródła LED dostępne na rynku mogą przekraczać radiacyjne możliwości wybranego profilu aluminiowego. W celu zapewnienia poprawnego działania, należy dobrać do profilu aluminiowego źródło LED o odpowiednich parametrach.



AESTHETICS / STRIP PROTECTION

An aluminium profile is a protection for a LED source against mechanical damage. The assembly is much more durable in comparison to gluing a LED strip directly to the surface. Using a profile increases aesthetics and facilitates maintaining cleanliness.

ESTETYKA / OCHRONA TAŚMY

Profil aluminiowy stanowi zabezpieczenie źródła LED przed mechanicznym uszkodzeniem. Montaż jest znacznie trwalszy w porównaniu z przyklejeniem taśmy LED bezpośrednio do podłoża. Użycie profilu podwyższa estetykę oraz ułatwia utrzymanie czystości.



ANODIZED COATING / COLOUR VERSIONS

In the standard TOPMET offer, aluminium LED profiles are available in 4 basic finishes:
white painted - powder coated,
anodised aluminium in silver colour,
anodised aluminium in black colour,
raw aluminium - economic version, not resistant to damage.

The most eagerly used ones are the anodized versions with a high degree of scratch resistance. The thickness of the anodic coating on all our profiles is about 15 μm .

ANODOWANA POWŁOKA / WERSJE KOLORYSTYCZNE

W standardowej ofercie TOPMET profile aluminiowe LED występują w 4 podstawowych wykończeniach:
biały malowany - powłoka farby proszkowej,
aluminium anodowane w kolorze srebrnym,
aluminium anodowane w kolorze czarnym,
aluminium surowe - wersja ekonomiczna, nieodporna na uszkodzenia.

Najchętniej stosowane są wersje anodowane o wysokim stopniu odporności na zarysowania. Grubość powłoki anodowej na wszystkich naszych profilach to około 15 μm .



ACCESSORIES

The design department is constantly working on expanding the offer with further components, which facilitate the assembly and multiply the possibilities of combinations, connections and assembly. Apart from system mounting plates, which match different profiles, many collections also have dedicated solutions for more advanced, specialist needs. The accessories for LED profiles include, i.a.: endings, covers, mounting plates, holders, extension arms, connectors, clamps, slings and many more.

AKCESORIA

Dział projektowy stale pracuje nad wzbogaceniem oferty w kolejne komponenty, które ułatwiają montaż i wielokrotnie zwiększają możliwości kombinacji, połączeń, montażu. Poza uchwytami systemowymi, pasującymi do różnych profili, wiele kolekcji ma także dedykowane rozwiązania do bardziej zaawansowanych, specjalistycznych potrzeb. Wśród akcesoriów do profili LED są m.in.: zaślepki, klosze, uchwyty, wysięgniki, łączniki, dociski, zawieszaki i wiele innych.



EU-registered industrial design
Wzory przemysłowe EU



Made in Poland
Wyprodukowane w Polsce

DESING / PRODUCTION

All profiles are unique - designed by TOPMET designers.
All the designs are registered - legally protected throughout the European Union.
TOPMET profiles, accessories and luminaires are manufactured in Poland.

PROJEKT / PRODUKCJA

Wszystkie profile są unikatowe – zaprojektowane przez projektantów TOPMET.
Wszystkie wzory są zarejestrowane – chronione prawnie na terenie całej Unii Europejskiej.
Profile, akcesoria i oprawy TOPMET wyprodukowane są w Polsce.



Why is it worth to choose LED technology? Dlaczego warto wybrać technologię LED?

ECONOMY / EKONOMIA

Comparison of light sources of similar lumen output / Porównanie źródeł światła o zbliżonej wartości strumienia świetlnego



traditional bulb
żarówka tradycyjna
power / moc: 100 W
price / cena: 0,78 €



halogen source
żarówka halogenowa
power / moc: 70 W
price / cena: 1,19 €



LED source
źródło LED
power / moc: 11,5 W
price / cena: 9,50 €

Energy / Energia

Watts necessary to obtain lumen output of 1000 lm / Ilość watów potrzebna do uzyskania światła o strumieniu 1000 lm

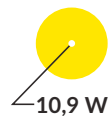
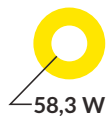
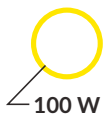

Lifespan / Żywotność

Time in hours for which one light source will glow until the lumen output decreases by 20 - 30% compared to the initial value

Czas podany w godzinach, w którym będzie świecić jedna żarówka zanim wartość strumienia świetlnego zmniejszy się o 20 - 30% w stosunku do wartości początkowej



Expenses / Wydatki

Amount and costs of worn-out light sources during one LED source lifespan / Ilość i koszt zużytych źródeł światła w okresie żywotności jednego źródła LED

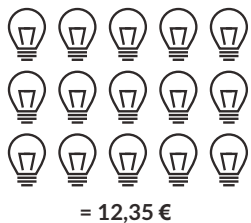

Daily costs of energy if the light glows for 8h* / Koszt energii z jednego dnia przy świetle zapalonym przez 8 h*

0,11 €

0,07 €

0,01 €

Costs of energy throughout the LED source lifespan* / Koszt energii z całego okresu żywotności źródła LED*

203,58 €

142,50 €

23,41 €

Total cost / Suma kosztów

of operation and light source prices** / eksploatacji oraz ceny źródła światła**

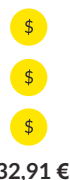
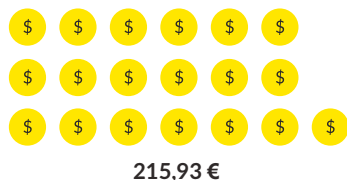

How much can you save by using a LED light source? ** / Ile można zaoszczędzić stosując źródło LED? **



In relation to traditional bulb
W stosunku do tradycyjnej żarówki
183,01 €



In relation to halogen source
W stosunku do żarówki halogenowej
118,55 €

* assuming the rate per 1 kWh at a level of: 0,14 € / przy założeniu stawki za 1 kWh na poziomie 0,14 €

** throughout the LED source lifespan / w całym okresie żywotności źródła LED

ECOLOGY / EKOLOGIA



What we should pay particular attention to is the impact of everyday use devices on the natural environment.

And so, lights using the LED technology are biodegradable, have a longer lifespan compared to traditional sources and consume less energy. Moreover, LED does not contain mercury.

less source replacements = less waste reaching the environment

To, na co powinniśmy zwrócić największą uwagę, to oddziaływanie na środowisko naturalne urządzeń codziennego użytku. I tak, światła wykorzystujące technologię LED są biodegradowalne, mają większą żywotność w stosunku do tradycyjnych źródeł oraz zużywają mniej energii. Ponadto LED nie zawiera rtęci.

mniej wymian źródeł = mniej odpadów trafiających do środowiska





2020 LED PROFILES

PROFILE LED

Sales support / Wsparcie sprzedaży

LED PROFILES SAMPLE BOX



LED PROFILES SAMPLE CASE



LED PROFILES SAMPLE BOARD



LED profiles / profile LED



VARIO30



big profiles / duże profile



LED PROFILES DISPLAY STAND

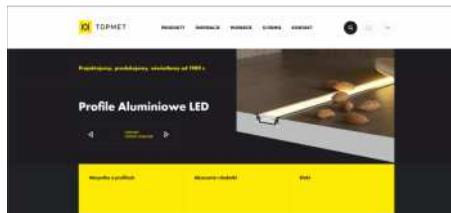

www.topmet.pl/en
www.topmet.pl



LED profile sets
Sety profili LED



LED luminaires catalogues
Karty katalogowe opraw LED



Professional consultancy service
Profesjonalne doradztwo

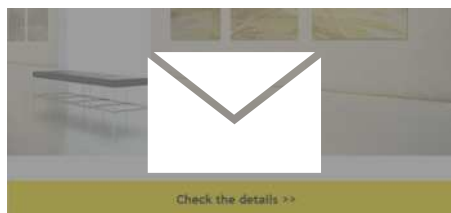

Newsletter



Photos
Zdjęcia

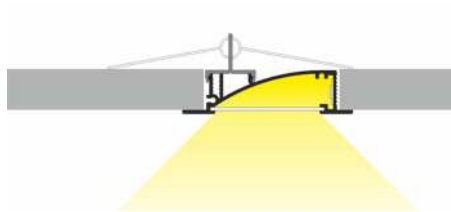

Graphics
Grafiki



We encourage to follow our social media accounts.
Zapraszamy do śledzenia naszych kont w mediach społecznościowych.

General terms and conditions available on website: <http://www.topmet.pl/en/tc/>
Ogólne warunki gwarancji dostępne są na stronie: <http://www.topmet.pl/pl/polityka-prywatnosci/>

See also / Zobacz również



TOPMET LED Luminaires

Oprawy LED TOPMET

SURFACE / NAWIERZCHNIOWE

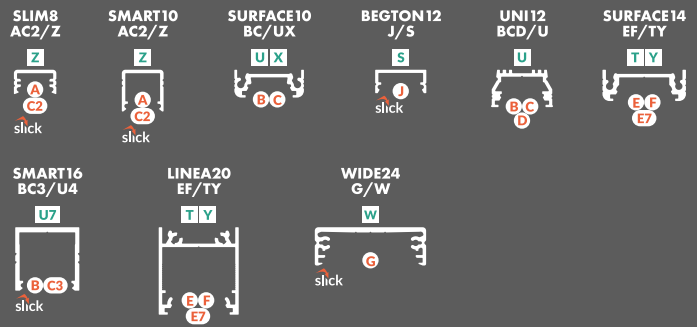

RECESSED / WPUSTOWE

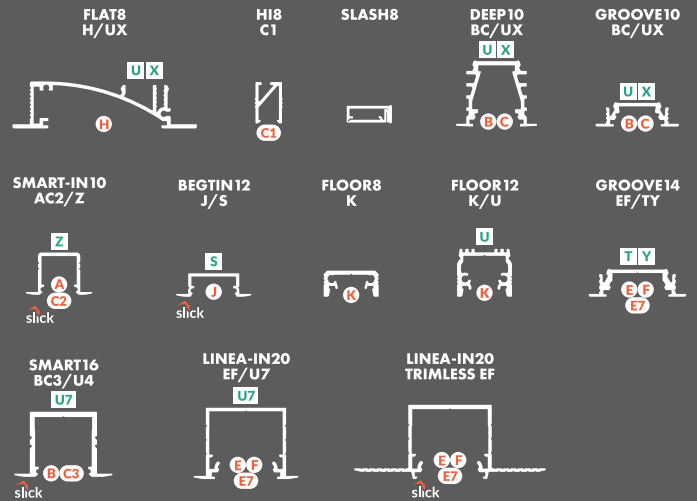

CORNER / KĄTOWE

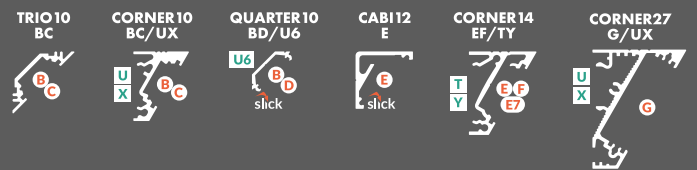

SPECIAL APPLICATION / SPECJALNE

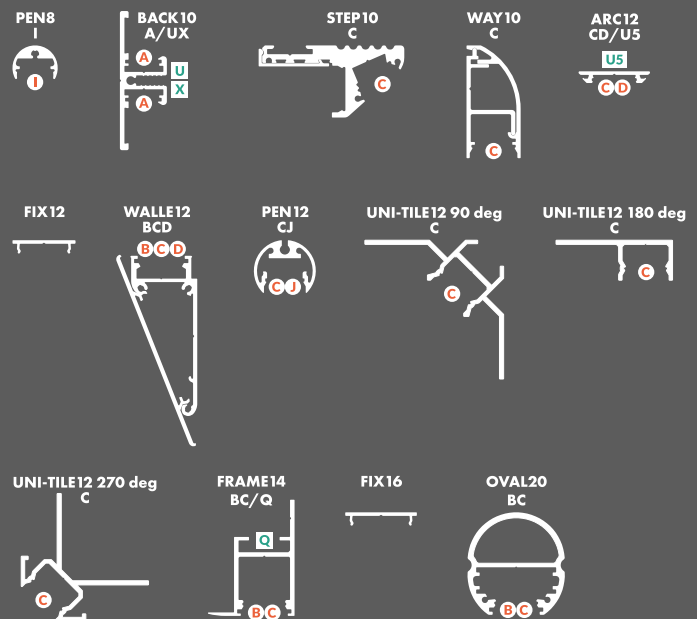

GLASS APPLICATION / DO SZKŁA

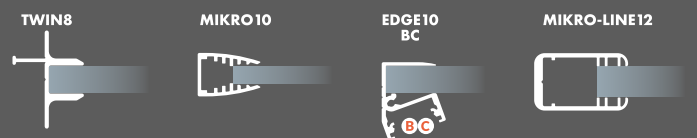



Made in Poland
Wyprodukowane w Polsce



EU-registered industrial design
Wzory przemysłowe EU

TOPMET Light Kłosowicz Wiśniewski i Wspólnik Sp. j.

HEADQUARTERS / SIEDZIBA GŁÓWNA: Ostrowska 354, 61-312 Poznań, POLAND

FACTORY & WAREHOUSE / PRODUKCJA I MAGAZYN: Ostrowska 532A, 61-312 Poznań, POLAND

tel. +48 61 87 27 500, biuro@topmet.pl, www.topmet.pl

The catalogue is not an offer under Polish Civil Code regulations. Colours of particular products may vary slightly from colours shown in pictures. The dimensions given are approximate and can not be a reason for complaint. TOPMET Company reserves the right to make technical changes.

Katalog nie stanowi oferty w myśl przepisów Kodeksu Cywilnego. Aktualną ofertę firmy stanowi cennik. Kolory poszczególnych produktów mogą się nieznacznie różnić od kolorów prezentowanych na zdjęciach. Podane wymiary są wymiarami orientacyjnymi i nie mogą stanowić podstawy reklamacji. Firma TOPMET zastrzega sobie prawo do wprowadzania zmian technicznych.

catalogue designer • proj. folderu: M. Kędziora, A. Szafran 12.2019, photo • fot.: K. Samulska, A. Szafran, S. Wawrzyn, L. Wesołowski, A. Wierdak
visualisations • wizualizacje: M. Kędziora, A. Szafran, P. Woś

Distributor / Dystrybutor

X-ON Electronics

Largest Supplier of Electrical and Electronic Components

Click to view similar products for [Topmet](#) manufacturer:

Other Similar products are found below :

[89160022](#) [C9990002](#) [C9990022](#) [86340022](#) [89060039](#) [76990022](#) [86490040](#) [89980001](#) [77260021](#) [77260001](#) [V4900022](#) [V4900040](#) [SMART-IN16 A/U4 ANOD 1M SET STD](#) [GROOVE10 C/U WH 1M SET STD](#) [BEGTON12 J/S WH 1M SET STD](#) [FLAT8 H/U ANOD 1M SET STD](#) [MIKRO10 ANOD 1M SET STD](#) [SMART10 A/Z WH 1M SET STD](#) [GROOVE14 F/Y WH 1M SET STD](#) [LINEA-IN20 F/U7 ANOD 1M SET STD](#) [SLIM8 A/Z ANOD 1M SET PRM](#) [FLAT8 H/U BK 1M SET PRM](#) [F9009902](#) [23070038P020](#) [23080038](#) [76510002](#) [83160001](#) [A2030038](#) [98070001](#) [83990001](#) [A1910001](#) [B8910001](#) [E3010001](#) [V4880022](#) [V4920002](#) [V3090020S](#) [FLAT8 H/U BK 1M SET STD](#) [SLIM8 A/Z WH 1M SET STD](#) [ARC12 D/U5 ANOD 1M SET STD](#) [CORNER14 F/Y ANOD 1M SET STD](#) [DEEP10 C/U BK 1M SET STD](#) [67120022](#) [A2050038](#) [92040022](#) [A1080040](#) [A2040016](#) [A2080002](#) [77990022](#) [83980002](#) [98050040](#)