

REV	ECN	DESCRIPTION	DRFT	DATE
-----	-----	-------------	------	------

NOTES1:

UL Standard

1. Rated voltage/current : 300V / 8A
2. Withstanding voltage : AC1600V/1Min.
3. Torque value : M2 , 1.77Lb.in
4. Wire range : 28~16AWG

IEC Standard

1. Pollution degree	2
Overvoltage category	II
Rate impulse voltage(KV)	2.5KV
Rate voltage(V)	250V
Rate current(A)	7A

2. Torque value : M2 , 0.2N•m
3. Wire range : 0.5~1.5mm<sup>2</sup>

NOTES2:

1. Dimension shall be interpreted per ASME Y14.5-2009
2. Pitch : 3.5/3.81mm, Poles : N=02~24P
3. Stripping length : 6~7mm
4. Operating temperature: -40°C~+105°C
5. Undimensioned tolerances:

Pitch range in mm		Nominal dimension range in mm				-	∩	∇
To	Over	To	Over	To	Over	To	To	To
6	10	10	24	30	60	100	150	0.1/10
±0.15	±0.20	±0.30	±0.30	±0.50	±0.70	±1.00	±1.30	±2'

6. RoHS Compliance

15ET YKM - 3.5/3.81 - XXP - 1Y - 00A (H)

(Series No.) (Pitch) (Poles) (Color): 1. (Grey)  
 2. (Blue)  
 3. (Black)  
 4. (Green)  
 5. (Orange)  
 6. (Red)  
 7. (Transparent)  
 8. (Yellow)  
 9. (White)

(RoHS)  
 00A-(Standard)

(Single Pitch)

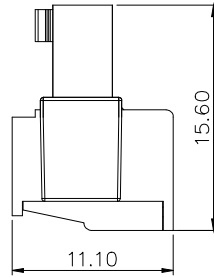
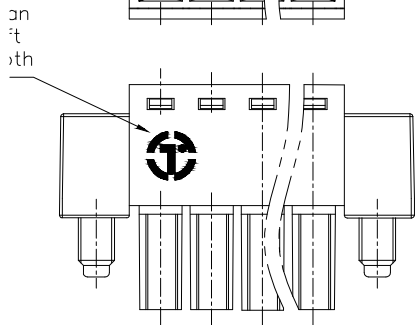
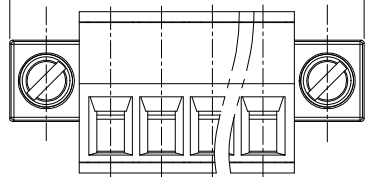
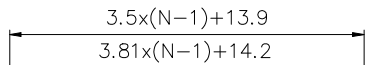
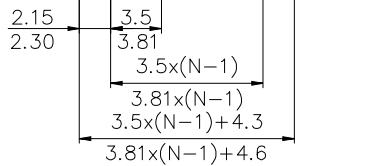
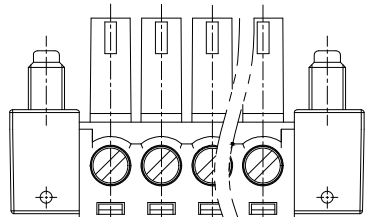
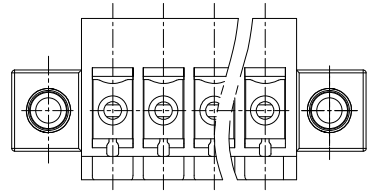

DETACHED LISTS	PART NO.:	拓宜 (上海) 工控电器设备有限公司			
	APPD:	NAME: 15ET YKM-3.5/3.81-XXP-1Y-00AH			
	CHKD:	TITLE: CUSTOMER DRAWING			
	DRFT:	DRAWING NO.:		REV	DO
THIRD ANGLE PROJECTION		MM (INCH)	DO NOT SCALE DRAWING	SHEET	1/1
			SCALE	1:1	

## X-ON Electronics

Largest Supplier of Electrical and Electronic Components

*Click to view similar products for [Pluggable Terminal Blocks](#) category:*

*Click to view products by [Toponelec](#) manufacturer:*

Other Similar products are found below :

[57.510.0053](#) [MC 1.5/ 6-ST-3.5 GY AU](#) [ET02015000J0G](#) [734-104](#) [734-302](#) [860505](#) [860516](#) [860810](#) [GBPACX-12](#) [93.731.4953.0](#) [PV05-5,08-K](#) [PVP03-3,50](#) [PVP04-3,50](#) [PVS02-5,00](#) [1-1986160-3](#) [1377680000](#) [1531000000](#) [1546228-5](#) [ELFP03110](#) [ELFT07250](#) [ELVD12100](#) [ELVF09400](#) [ELVP03100](#) [ELXH071G0E](#) [1700410](#) [1702246](#) [1705229](#) [1714537](#) [1717806](#) [1719600](#) [1728941](#) [1734692](#) [1734795](#) [1740291](#) [1740628](#) [1746952](#) [1750207](#) [1752865](#) [1754115](#) [1754144](#) [1756913](#) [1760051](#) [1760336](#) [1765111](#) [1776388](#) [1777701](#) [1783410](#) [1800227](#) [1801080](#) [1809474](#)