

REV	ECN	DESCRIPTION	DRFT	DATE
-----	-----	-------------	------	------

NOTES1:

UL Standard

1. Rated voltage/current : 300V / 8A
2. Withstanding voltage : AC1600V/1Min.
3. Torque value : M2 , 1.77Lb.in
4. Wire range : 28~16AWG

IEC Standard

1. Pollution degree	2
Overvoltage category	II
Rate impulse voltage(KV)	2.5KV
Rate voltage(V)	250V
Rate current(A)	7A

2. Torque value : M2 , 0.2N•m
3. Wire range : 0.5~1.5mm²

NOTES2:

1. Dimension shall be interpreted per ASME Y14.5-2009
2. Pitch : 3.5/3.81mm, Poles : N=02~24P
3. Stripping length : 6~7mm
4. Operating temperature: -40°C~+105°C
5. Undimensioned tolerances:

Pitch range in mm		Nominal dimension range in mm				-	∩	∇
To	Over	To	Over	To	Over	To	To	To
6	10	10	24	30	60	100	150	0.1/10
±0.15	±0.20	±0.30	±0.30	±0.50	±0.70	±1.00	±1.30	±2'

6. RoHS Compliance

15ET YKM - 3.5/3.81 - XXP - 1Y - 00A (H)

(Series No.) (Pitch) (Poles) (Color): 1. (Grey)
 2. (Blue)
 3. (Black)
 4. (Green)
 5. (Orange)
 6. (Red)
 7. (Transparent)
 8. (Yellow)
 9. (White)

(RoHS)
 00A-(Standard)

(Single Pitch)

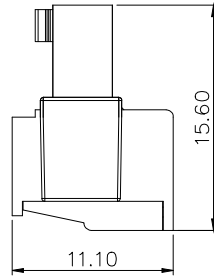
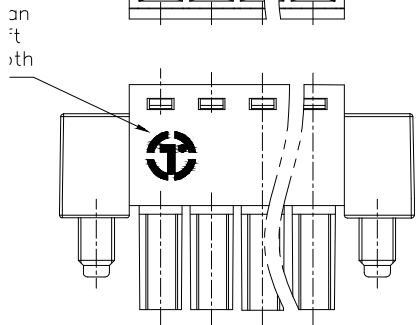
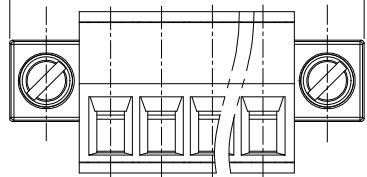
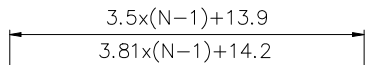
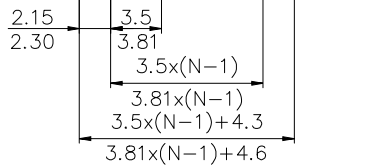
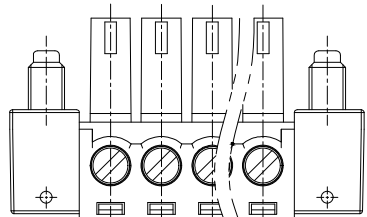
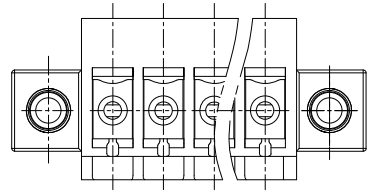

DETACHED LISTS	PART NO.:	拓宜 (上海) 工控电器设备有限公司		
	APPD:	NAME: 15ET YKM-3.5/3.81-XXP-1Y-00AH		
	CHKD:	TITLE: CUSTOMER DRAWING		
	DRFT:	REV	DO	
DRAWING NO.:		SHEET	1/1	
THIRD ANGLE PROJECTION		SCALE	1:1	

X-ON Electronics

Largest Supplier of Electrical and Electronic Components

Click to view similar products for [Pluggable Terminal Blocks](#) category:

Click to view products by [Toponelec](#) manufacturer:

Other Similar products are found below :

[57.510.0053](#) [MC 1.5/ 6-ST-3.5 GY AU](#) [ET02015000J0G](#) [860505](#) [860516](#) [860810](#) [GBPACX-12](#) [93.731.4953.0](#) [PV05-5,08-K](#) [PVP03-3,50](#)
[PVS02-5,00](#) [1-1986160-3](#) [1377680000](#) [1531000000](#) [1546228-5](#) [ELFP03110](#) [ELFP10210](#) [ELFT07250](#) [ELVD12100](#) [ELVF09400](#)
[ELVP03100](#) [ELXH071G0E](#) [1700410](#) [1746952](#) [1760336](#) [1800272](#) [1809474](#) [1855000000](#) [19346](#) [1946309](#) [1950227](#) [1973592](#) [19892](#) [2-](#)
[1546857-6](#) [25.320.4053.1](#) [25.320.4553.9](#) [25.320.4753.1](#) [25.320.5453.1](#) [25.340.0353.1](#) [25.340.1053.1](#) [25.345.3553.0M001](#) [25.640.3553.1](#)
[SH02-5,08](#) [SH06-3,81](#) [SH08-5,08](#) [SH08-5,08-K](#) [SH12-5,08](#) [SHS04-5,00](#) [30.303](#) [30.305](#)