

REVISION RECORD				
REV	ECN	DESCRIPTION	DRFT	DATE

NOTES1:

UL Standard

- 1.Rated voltage/current : 300V / 8A
- 2.Withstanding voltage : AC1600V/1Min.

IEC Standard

1. Pollution Degree	2
Overvoltage Category	<b>II</b>
Rate Impulse Voltage(KV)	2.5KV
Rate Voltage(V)	250V
Rate Current(A)	7A

NOTES2:

- 1.Dimension shall be interpreted per ASME Y14.5-2009
- 2.Pitch : 3.5/3.81mm, Poles : N=02~22P
- 3.Operating temperature: -40°C~+105°C
- 4.Undimensioned tolerances:

Pitch range in mm	Nominal dimension range in mm							0.1/10
	Over 6 TO 10	Over 10 TO 24	Over 30 TO 60	Over 60 TO 100	Over 100 TO 150	Over 150 TO 300	Over 300 TO 600	
±0.15	±0.20	±0.30	±0.30	±0.50	±0.70	±1.00	±1.30	±2*

5.RoHS Compliance

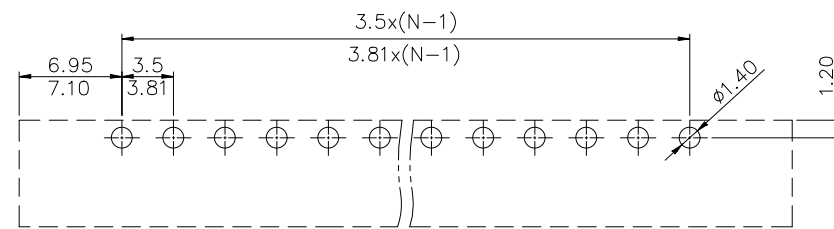
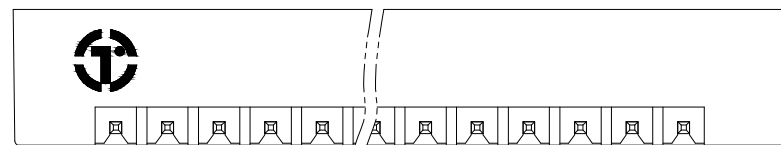
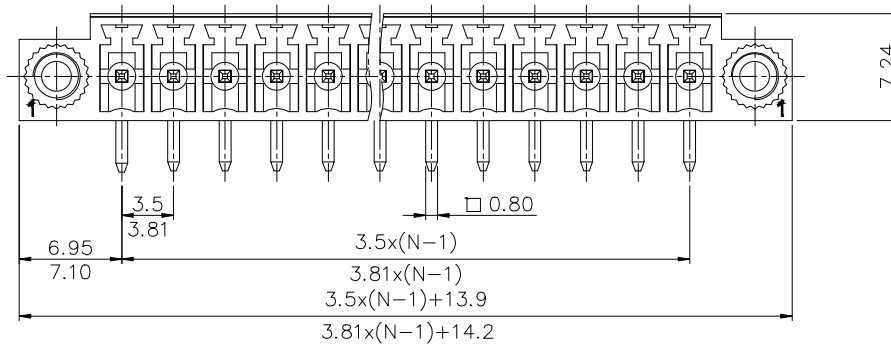
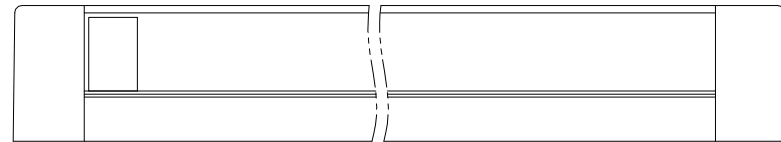
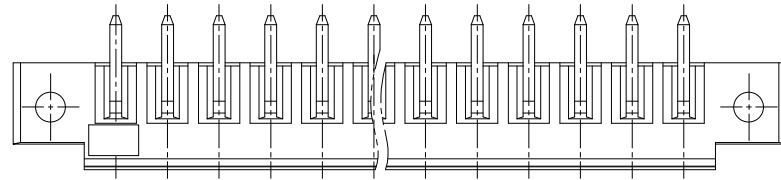
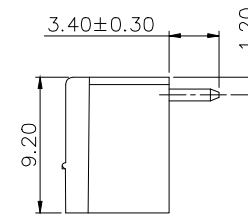

PCB LAYOUT

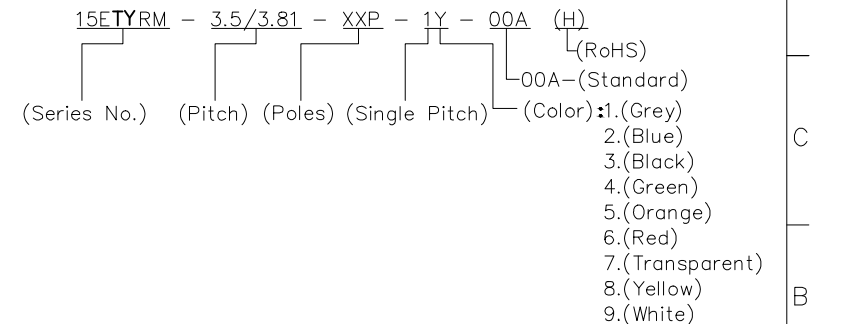

DETACHED LISTS	PART NO.:	拓宜 (上海) 工控电器设备有限公司			
	APPD:	NAME: 15ETYRM-3.5/3.81-XXP-1Y-00A(H)			
	CHKD:	TITLE: CUSTOMER DRAWING		REV	DO
	DRFT:	DRAWING NO.:		SHEET	1/1
THIRD ANGLE PROJECTION		DO NOT SCALE DRAWING		SCALE	1:1

## X-ON Electronics

Largest Supplier of Electrical and Electronic Components

*Click to view similar products for [Pluggable Terminal Blocks](#) category:*

*Click to view products by [Toponelec](#) manufacturer:*

Other Similar products are found below :

[57.510.0053](#) [MC 1.5/ 6-ST-3.5 GY AU](#) [ET02015000J0G](#) [734-104](#) [734-302](#) [860505](#) [860516](#) [860810](#) [GBPACX-12](#) [93.731.4953.0](#) [PV05-5,08-K](#) [PVP03-3,50](#) [PVP04-3,50](#) [PVS02-5,00](#) [1-1986160-3](#) [1377680000](#) [1531000000](#) [1546228-5](#) [ELFP03110](#) [ELFT07250](#) [ELVD12100](#) [ELVF09400](#) [ELVP03100](#) [ELXH071G0E](#) [1700410](#) [1702246](#) [1705229](#) [1714537](#) [1717806](#) [1719600](#) [1728941](#) [1734692](#) [1734795](#) [1740291](#) [1740628](#) [1746952](#) [1750207](#) [1752865](#) [1754115](#) [1754144](#) [1756913](#) [1760051](#) [1760336](#) [1765111](#) [1776388](#) [1777701](#) [1783410](#) [1800227](#) [1801080](#) [1809474](#)