

Material :

- (a) Cover : PA66(UL94V-0)
- (b) Contact : Phosphor Bronze
- (c) Cage : Brass , Ni Plated
- (d) Housing : PA66(UL94V-0)
- (e) Screws : Steel , Cr³⁺Zn Plated

Electrical :

- | | | |
|------------------------------|------------------|--------------------|
| | UL | IEC |
| 1.Rated Voltage : | 300V | 320V |
| 2.Rated Current : | 15A | 10A |
| 3.Torque Value : | M2.5 , 3.54Lb.in | M2.5 , 0.4N.m |
| 4.Wire Range: | 28-12AWG | 2.5mm ² |
| 5.Stripping Length : | 7-8mm | |
| 6.Withstanding Voltage : | AC1600V/1Min. | |
| 7.Operating Temperature : | -40 °C~+105 °C | |
| 8.RoHS Compliance | | |
| 9.Safety Approval : | cULus | |
| 10.Undimensioned Tolerances: | | |

Pitch Range In mm		Nominal Dimension Range In mm					- / □ / ▽	
≤6	6 ~ 10	10 ~ 24	≤30	30 ~ 60	60 ~ 100	100 ~ 150	>150	0.05/10
±0.10	±0.15	±0.25	±0.20	±0.30	±0.50	±0.70	±1.00	±0.1°

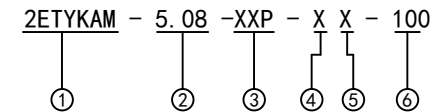
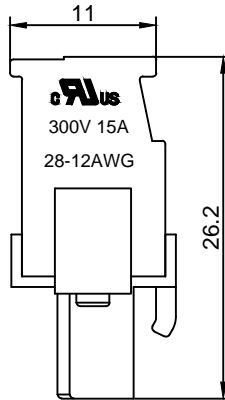
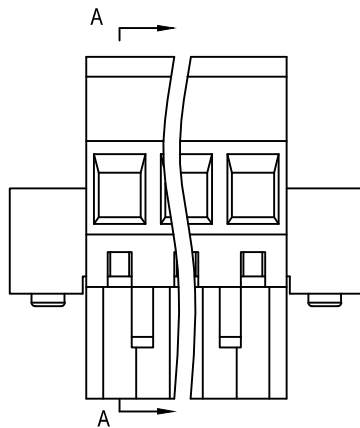
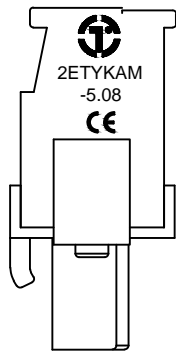

- ① Series NO.
- ② Pitch
- ③ Poles
- ④ 1 Single Pitch
2 Double Pitch
- ⑤ Color: 1 Grey
2 Blue
3 Black
4 Green(Standard For AH)
5 Orange
6 Red
7 Transparent
8 Yellow
9 White
- ⑥ Customer Request:
100--Standard M2.5

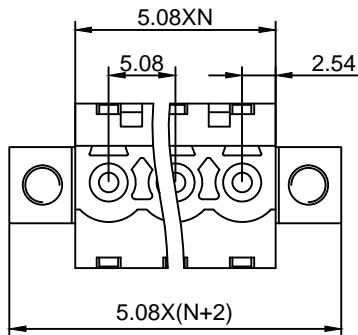
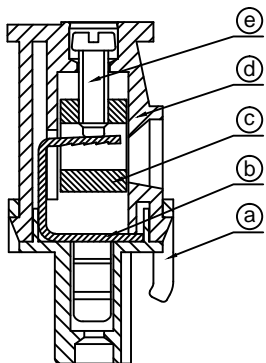

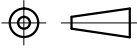
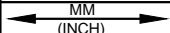
DETACHED LISTS	 拓宜(上海)工控电器设备有限公司 Topone(Shanghai) Industrial Control Electrical Equipment Co., LTD.	
	APPD: MA_9/16/16 '	PART NO. 2ETYKAM-5.08-XXP-XX-100
	CHKD: Yu_9/15/16 '	
	DRFT: Chen_9/14/16 '	
 THIRD ANGLE PROJECTION		DRAWING NO. _____ REV 1 SHEET 1/1 SCALE 1/1
 MM (INCH)		DO NOT SCALE DRAWING

X-ON Electronics

Largest Supplier of Electrical and Electronic Components

Click to view similar products for [Pluggable Terminal Blocks](#) category:

Click to view products by [Toponelec](#) manufacturer:

Other Similar products are found below :

[57.510.0053](#) [721-104/026-047](#) [721-204/026-045](#) [MC 1.5/ 6-ST-3.5 GY AU](#) [ET02015000J0G](#) [860505](#) [860516](#) [860810](#) [GBPACX-12](#)
[93.731.4953.0](#) [PVP03-3,50](#) [PVS02-5,00](#) [1-1986160-3](#) [1377680000](#) [1531000000](#) [1546228-5](#) [ELFP03110](#) [ELFP10210](#) [ELFT07250](#)
[ELVD12100](#) [ELVF09400](#) [ELXH071G0E](#) [1725220000](#) [1760336](#) [1855000000](#) [19346](#) [1946309](#) [1973592](#) [19892](#) [25.320.4053.1](#) [25.320.4553.9](#)
[25.320.4753.1](#) [25.320.5453.1](#) [25.340.0353.1](#) [25.340.1053.1](#) [25.345.3553.0M001](#) [25.640.3553.1](#) [SH02-5,08](#) [SH06-3,81](#) [SH08-5,08](#) [SH08-](#)
[5,08-K](#) [SH12-5,08](#) [SHS04-5,00](#) [30.303](#) [30.305](#) [30.306](#) [PHP09-5,08](#) [25.193.0453.0](#) [25.320.4653.1](#) [25.332.2453.1](#)