

High Current, High Speed LDO Regulators

■ GENERAL DESCRIPTION

The XC6210 series are precise, low noise, high current, positive voltage low dropout regulators. They are fabricated using Torex's CMOS process.

The series features a voltage reference, an error amplifier, a current limiter, and a phase compensation circuit plus a driver transistor. With a low ON resistance driver transistor built into, batteries can be used until input-output voltage differential is minimal and can accordingly be used for a longer time.

The series is also compatible with low ESR ceramic capacitors which give added output stability.

The output voltage of the LDO is selectable in 0.05V increments within the range of 0.80V to 5.00V.

The current limiter's foldback circuit also operates as the output current limiter and the output pin protection.

The IC's internal regulator circuit can be placed in stand-by mode via the CE function. In the stand-by mode, power consumption is greatly reduced.

■ APPLICATIONS

- Optical disk drive
- Magnetic disk drive
- Digital still cameras / Camcorders
- Digital audio equipments
- Multi-function power supplies

■ FEATURES

- Maximum Output Current** : More than 700mA
(800mA limit, TYP.)
($1.60V \leq V_{OUT} \leq 5.00V$)
- Dropout Voltage** : 50mV @ 100mA
: 100mV @ 200mA
- Operating Voltage Range** : 1.50V ~ 6.00V
- Output Voltage Range** : 0.80V ~ 5.00V (0.05V increments)
- Highly Accurate** : $\pm 2\%$ ($1.55V \leq V_{OUT} \leq 5.00V$)
: $\pm 30mV$ ($0.80V \leq V_{OUT} \leq 1.50V$)
- Low Power Consumption** : 35 μ A (TYP.)
- High Ripple Rejection** : 60dB @ 1kHz
- Operational Ambient Temperature** : -40°C ~ 85°C

CMOS

Low ESR Capacitor Compatible

- Packages** : SOT-25
: SOT-89-5
: USP-6B

Environmentally Friendly : EU RoHS Compliant, Pb Free

■ TYPICAL APPLICATION CIRCUIT



■ TYPICAL PERFORMANCE CHARACTERISTICS

- Dropout Voltage vs. Output Current



■ BLOCK DIAGRAM

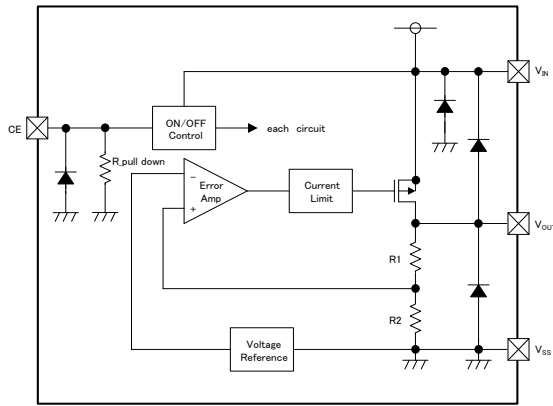

XC6210A Series



XC6210B/D Series

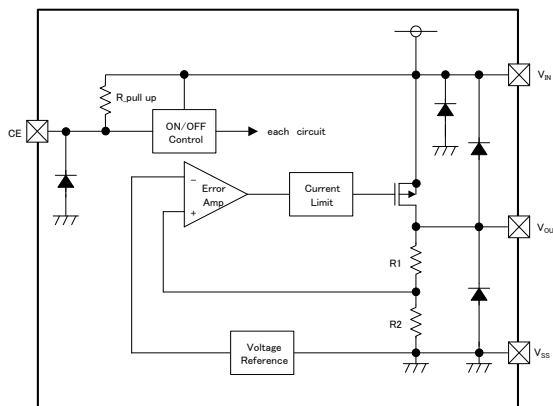

XC6210C Series

*Diodes shown in the above circuit are ESD protection diodes and parasitic diodes

■ PRODUCT CLASSIFICATION

● Ordering Information

XC6210 ①②③④⑤⑥-⑦^(*)

| DESIGNATOR | ITEM | SYMBOL | DESCRIPTION |
|---------------------|-------------------------|---------|--|
| ① | Type | A | Refer to Selection Guide |
| | | B | |
| | | C | |
| | | D | |
| ②③ | Output Voltage | 08 ~ 50 | e.g. 3.00V → ②=3, ③=0 |
| ④ | Output Voltage Accuracy | 2 | Output voltage {x.x0v} (the 2nd decimal place is "0") $0.80V \leq V_{OUT(T)} \leq 1.50V : V_{OUT(T)} \pm 30mV$ $1.60V \leq V_{OUT(T)} \leq 5.00V : V_{OUT(T)} \pm 2\%$ e.g. 3.00V → ②=3, ③=0, ④=2 |
| | | A | Output voltage {x.x5v} (the 2nd decimal place is "5") $0.85V \leq V_{OUT(T)} \leq 1.45V : V_{OUT(T)} \pm 30mV$ $1.55V \leq V_{OUT(T)} \leq 4.95V : V_{OUT(T)} \pm 2\%$ e.g. 3.05V → ②=3, ③=0, ④=A |
| ⑤⑥-⑦ ^(*) | Packages | MR | SOT-25 (3,000pcs/Reel) |
| | | MR-G | SOT-25 (3,000pcs/Reel) |
| | | PR | SOT-89-5 (1,000pcs/Reel) |
| | | PR-G | SOT-89-5 (1,000pcs/Reel) |
| | | DR | USP-6B (3,000pcs/Reel) |
| | | DR-G | USP-6B (3,000pcs/Reel) |

^(*) The "-G" suffix indicates that the products are Halogen and Antimony free as well as being fully EU RoHS compliant.

● Selection Guide

| TYPE | CE High Active | CE Low Active | CE PULL-DOWN RESISTOR | CE PULL-UP RESISTOR |
|------|----------------|---------------|-----------------------|---------------------|
| A | Yes | No | Yes | No |
| B | Yes | No | No | No |
| C | No | Yes | No | Yes |
| D | No | Yes | No | No |

PIN CONFIGURATION



SOT-25
(TOP VIEW)

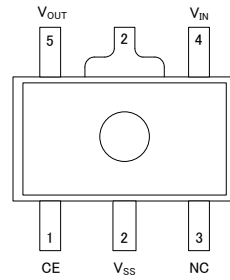

SOT-89-5
(TOP VIEW)

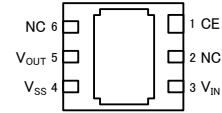

USP-6B
(BOTTOM VIEW)

*The dissipation pad for the USP-6B package should be solder-plated in reference mount pattern and metal masking so as to enhance mounting strength and heat release. If the pad needs to be connected to other pins, it should be connected to the Vss pins.

PIN ASSIGNMENT

| PIN NUMBER | | | PIN NAME | FUNCTION |
|------------|----------|--------|------------------|----------------|
| SOT-25 | SOT-89-5 | USP-6B | | |
| 3 | 1 | 1 | CE | ON/OFF Control |
| 1 | 4 | 3 | V _{IN} | Power Input |
| 2 | 2 | 4 | V _{SS} | Ground |
| 5 | 5 | 5 | V _{OUT} | Output |
| 4 | 3 | 2, 6 | NC | No Connection |

■ PIN FUNCTION ASSIGNMENT

1) XC6210 Series A Type (CE High Active, CE pull-down resistor)

| PIN NAME | SIGNAL | STATUS |
|----------|--------|----------|
| CE | H | Active |
| | L | Stand-by |
| | OPEN | |

2) XC6210 Series B Type (CE High Active, CE no pull-down resistor)

| PIN NAME | SIGNAL | STATUS |
|----------|--------|-----------------|
| CE | H | Active |
| | L | Stand-by |
| | OPEN | Undefined state |

3) XC6210 Series C Type (CE Low Active, CE pull-up resistor)

| PIN NAME | SIGNAL | STATUS |
|----------|--------|----------|
| CE | H | Stand-by |
| | L | Active |
| | OPEN | Stand-by |

4) XC6210 Series D Type (CE Low Active, CE no pull-up resistor)

| PIN NAME | SIGNAL | STATUS |
|----------|--------|-----------------|
| CE | H | Stand-by |
| | L | Active |
| | OPEN | Undefined state |

■ ABSOLUTE MAXIMUM RATINGS

| PARAMETER | SYMBOL | RATINGS | UNITS |
|---|-----------|--|------------------|
| Input Voltage | V_{IN} | 6.5 | V |
| Output Current * | I_{OUT} | 900 | mA |
| Output Voltage | V_{OUT} | $V_{SS} - 0.3 \sim V_{IN} + 0.3$ | V |
| CE Pin Voltage | V_{CE} | $V_{SS} - 0.3 \sim 6.5$ | V |
| Power Dissipation ($T_a=25^\circ\text{C}$) | SOT-25 | 250 | mW |
| | | 600 (40mm x 40mm standard board) ^(*)2) | |
| | | 760 (JESD51-7 board) ^(*)2) | |
| | SOT-89-5 | 500 | |
| | | 1300 (40mm x 40mm standard board) ^(*)2) | |
| | USP-6B | 1750 (JESD51-7 board) ^(*)2) | |
| | | 1000 (40mm x 40mm standard board) ^(*)2) | |
| Operating Temperature Range | T_{opr} | -40 ~ 85 | $^\circ\text{C}$ |
| Storage Temperature Range | T_{stg} | -55 ~ 125 | $^\circ\text{C}$ |

(*) $I_{OUT}=P_d / (V_{IN} - V_{OUT})$

(*)2) The power dissipation figure shown is PCB mounted and is for reference only.
The mounting condition is please refer to PACKAGING INFORMATION.

ELECTRICAL CHARACTERISTICS

●XC6210 series

Ta=25°C

| PARAMETER | SYMBOL | CONDITIONS | MIN. | TYP. | MAX. | UNIT | CIRCUIT |
|--|---|---|---------|-------------------------------------|---------|------------|---------|
| Output Voltage | V _{OUT(E)} ^{(*)3} | V _{IN} =V _{OUT(T)} +1.0V, I _{OUT} =30mA V _{CE} =ON (V _{IN} or V _{SS}) (V _{OUT(T)} > 1.50V) | x 0.98 | V _{OUT(T)} ^{(*)2} | x 1.02 | V | ① |
| | | V _{IN} =V _{OUT(T)} +1.0V, I _{OUT} =30mA, V _{CE} =ON(V _{IN} or V _{SS})(V _{OUT(T)} ≤ 1.50V) | (-30mV) | V _{OUT(T)} ^{(*)2} | (+30mV) | | |
| Maximum Output Current | I _{OUTMAX} | V _{IN} =V _{OUT(T)} +1.0V, V _{CE} =ON(V _{IN} or V _{SS}) (V _{OUT(T)} > 1.50V) | 700 | - | - | mA | ① |
| | | V _{IN} =V _{OUT(T)} +1.0V, V _{CE} =ON(V _{IN} or V _{SS}) (V _{OUT(T)} ≤ 1.50V) | 500 | - | - | | |
| Load Regulation | ΔV _{OUT} | 1mA≤I _{OUT} ≤100mA, V _{CE} =ON(V _{IN} or V _{SS}) | - | 15 | 60 | mV | ① |
| Dropout Voltage | V _{dif1} ^{(*)4} | I _{OUT} =30mA, V _{CE} =ON(V _{IN} or V _{SS}) | E-1 | | | mV | ① |
| | V _{dif2} ^{(*)4} | I _{OUT} =100mA, V _{CE} =ON(V _{IN} or V _{SS}) | E-2 | | | | |
| Supply Current (A type) | I _{DD} | V _{IN} =V _{CE} =V _{OUT(T)} +1.0V | E-3 | | | μA | ② |
| Supply Current (B type) | | V _{IN} =V _{CE} =V _{OUT(T)} +1.0V | - | 35 | 55 | | |
| Supply Current (C type) | | V _{IN} =V _{OUT(T)} +1.0V, V _{CE} =V _{SS} | E-3 | | | | |
| Supply Current (D type) | | V _{IN} =V _{OUT(T)} +1.0V, V _{CE} =V _{SS} | - | 35 | 55 | | |
| Stand-by Current | I _{STBY} | V _{IN} =6.0V, V _{CE} =OFF(V _{IN} or V _{SS}) | -0.10 | - | 0.10 | μA | ② |
| Line Regulation | $\frac{\Delta V_{OUT}}{\Delta V_{IN} \cdot V_{OUT}}$ | V _{OUT(T)} +1.0V≤V _{IN} ≤6.0V V _{CE} =ON(V _{IN} or V _{SS}), I _{OUT} =30mA V _{OUT(T)} <4.50V | - | 0.01 | 0.20 | % / V | ① |
| | | 5.5V≤V _{IN} ≤6.0V V _{CE} =ON(V _{IN} or V _{SS}), I _{OUT} =30mA V _{OUT(T)} ≥4.50V | | | | | |
| Input Voltage | V _{IN} | - | 1.5 | - | 6.0 | V | - |
| Output Voltage Temperature Characteristics | $\frac{\Delta V_{OUT}}{\Delta T_{opr} \cdot V_{OUT}}$ | I _{OUT} =30mA, V _{CE} =ON (V _{IN} or V _{SS}) -40°C≤T _{opr} ≤85°C | - | ±100 | - | ppm/ °C | ① |
| Ripple Rejection Rate | PSRR | V _{IN} =[V _{OUT(T)} +1.0]V _{DC} +0.5V _{P-PAC} V _{CE} =ON(V _{IN} or V _{SS}), I _{OUT} =30mA, f=1kHz V _{OUT(T)} <4.75V | - | 60 | - | dB | ③ |
| | | V _{IN} =5.75V _{DC} +0.5V _{P-PAC} V _{CE} =ON(V _{IN} or V _{SS}), I _{OUT} =30mA, f=1kHz V _{OUT(T)} ≥4.75V | | | | | |
| Current Limiter | I _{LIM} | V _{IN} =V _{OUT(T)} +1.0V, V _{CE} =ON(V _{IN} or V _{SS}) V _{OUT(T)} >1.50V | 700 | 800 | - | mA | ① |
| | | V _{IN} =V _{OUT(T)} +1.0V, V _{CE} =ON(V _{IN} or V _{SS}) V _{OUT(T)} ≤1.50V | - | 800 | - | | |
| Short-Circuit Current | I _{SHORT} | V _{IN} =V _{OUT(T)} +1.0V, V _{CE} =ON(V _{IN} or V _{SS}) | - | 50 | - | mA | ① |
| CE "H" Level Voltage | V _{CEH} | - | 1.3 | - | 6.0 | V | ① |
| CE "L" Level Voltage | V _{CEL} | - | - | - | 0.25 | | |
| CE "H" Level Current | I _{CEH} | V _{CE} =V _{IN} =V _{OUT(T)} +1.0V (Type A) | E-4 | - | E-4 | μA | ① |
| | | V _{CE} =V _{IN} =V _{OUT(T)} +1.0V (Type B/C/D) | - 0.10 | - | 0.10 | | |
| CE "L" Level Current | I _{CEL} | V _{IN} =V _{OUT(T)} +1.0V, V _{CE} =V _{SS} (Type C) | E-5 | - | E-5 | μA | ① |
| | | V _{IN} =V _{OUT(T)} +1.0V, V _{CE} =V _{SS} (Type A/B/D) | - 0.10 | - | 0.10 | | |

NOTE:

*1: Unless otherwise stated, V_{IN}=V_{OUT(T)}+1.0V

*2: V_{OUT(T)}=Specified output voltage

*3: V_{OUT(E)}=Effective output voltage

(i.e. the output voltage when "V_{OUT(T)}+1.0V" is provided while maintaining a certain I_{OUT} value).

4: V_{dif}={V_{IN1}^{()6}-V_{OUT1}^{(*)5}}

*5: A voltage equal to 98% of the output voltage whenever a stabilized V_{OUT1}=I_{OUT}{V_{OUT(T)}+1.0V} is input.

*6: V_{IN1}= the input voltage when V_{OUT1}, which appears as input voltage is gradually decreased.

*7: V_{CE} conditions: XC6210 Series A / B type: ON=V_{IN}, OFF=V_{SS}
XC6210 Series C / D type: ON=V_{SS}, OFF=V_{IN}

VOLTAGE CHART

● Dropout Voltage, Supply Current, CE "H / L" Level Current Chart

Ta=25°C

| SETTING OUTPUT VOLTAGE | Output Voltage | | E-1 | | E-2 | | E-3 | | E-4 | | E-5 | |
|------------------------------|------------------|-------|---|-------|--|-------|-----------------|------|-------------------------|-------|-------------------------|-------|
| | | | Dropout Voltage (I _{OUT} =30mA) | | Dropout Voltage (I _{OUT} =100mA) | | Supply Current | | CE "H" Level Current | | CE "L" Level Current | |
| (V) | (V) | | (mV) | | (mV) | | (μA) | | (μA) | | (μA) | |
| V _{OUT(T)} | V _{OUT} | | Vdif1 | | Vdif2 | | I _{DD} | | I _{CEH} | | I _{CEL} | |
| | MIN. | MAX. | TYP. | MAX. | TYP. | MAX. | TYP. | MAX. | MIN. | MAX. | MIN. | MAX. |
| 0.80 | 0.770 | 0.830 | 100.0 | 700.0 | 250.0 | 800.0 | 38.0 | 60.0 | 1.50 | 5.00 | -5.00 | -1.50 |
| 0.85 | 0.820 | 0.880 | | | | | | | | | | |
| 0.90 | 0.870 | 0.930 | | | | | | | | | | |
| 0.95 | 0.920 | 0.980 | | | | | | | | | | |
| 1.00 | 0.970 | 1.030 | 50.0 | 500.0 | 150.0 | 600.0 | 38.5 | 61.5 | 2.00 | 6.50 | -6.50 | -2.00 |
| 1.05 | 1.020 | 1.080 | | | | | | | | | | |
| 1.10 | 1.070 | 1.130 | | | | | | | | | | |
| 1.15 | 1.120 | 1.180 | | | | | | | | | | |
| 1.20 | 1.170 | 1.230 | 30.0 | 300.0 | 100.0 | 400.0 | 39.0 | 63.0 | 2.50 | 8.00 | -8.00 | -2.50 |
| 1.25 | 1.220 | 1.280 | | | | | | | | | | |
| 1.30 | 1.270 | 1.330 | | | | | | | | | | |
| 1.35 | 1.320 | 1.380 | | | | | | | | | | |
| 1.40 | 1.370 | 1.430 | 27.0 | 41.0 | 90.0 | 135.0 | 39.5 | 64.5 | 3.00 | 9.50 | -9.50 | -3.00 |
| 1.45 | 1.420 | 1.480 | | | | | | | | | | |
| 1.50 | 1.470 | 1.530 | | | | | | | | | | |
| 1.55 | 1.519 | 1.581 | | | | | | | | | | |
| 1.60 | 1.568 | 1.632 | | | | | | | | | | |
| 1.65 | 1.617 | 1.683 | | | | | | | | | | |
| 1.70 | 1.666 | 1.734 | | | | | | | | | | |
| 1.75 | 1.715 | 1.785 | | | | | | | | | | |
| 1.80 | 1.764 | 1.836 | | | | | | | | | | |
| 1.85 | 1.813 | 1.887 | | | | | | | | | | |
| 1.90 | 1.862 | 1.938 | 25.0 | 37.0 | 80.0 | 120.0 | 40.0 | 66.0 | 3.50 | 11.00 | -11.00 | -3.50 |
| 1.95 | 1.911 | 1.989 | | | | | | | | | | |
| 2.00 | 1.960 | 2.040 | | | | | | | | | | |
| 2.05 | 2.009 | 2.091 | | | | | | | | | | |
| 2.10 | 2.058 | 2.142 | | | | | | | | | | |
| 2.15 | 2.107 | 2.193 | | | | | | | | | | |
| 2.20 | 2.156 | 2.244 | | | | | | | | | | |
| 2.25 | 2.205 | 2.295 | | | | | | | | | | |
| 2.30 | 2.254 | 2.346 | | | | | | | | | | |
| 2.35 | 2.303 | 2.397 | | | | | | | | | | |
| 2.40 | 2.352 | 2.448 | 18.0 | 28.0 | 60.0 | 90.0 | 40.0 | 66.0 | 3.50 | 11.00 | -11.00 | -3.50 |
| 2.45 | 2.401 | 2.499 | | | | | | | | | | |
| 2.50 | 2.450 | 2.550 | | | | | | | | | | |
| 2.55 | 2.499 | 2.601 | | | | | | | | | | |
| 2.60 | 2.548 | 2.652 | | | | | | | | | | |
| 2.65 | 2.597 | 2.703 | | | | | | | | | | |
| 2.70 | 2.646 | 2.754 | | | | | | | | | | |
| 2.75 | 2.695 | 2.805 | | | | | | | | | | |
| 2.80 | 2.744 | 2.856 | | | | | | | | | | |
| 2.85 | 2.793 | 2.907 | | | | | | | | | | |
| 2.90 | 2.842 | 2.958 | | | | | | | | | | |
| 2.95 | 2.891 | 3.009 | | | | | | | | | | |

VOLTAGE CHART (Continued)

● Dropout Voltage, Supply Current, CE "H / L" Level Current Chart

Ta=25°C

| SETTING OUTPUT VOLTAGE | Output Voltage | | E-1 | | E-2 | | E-3 | | E-4 | | E-5 | |
|------------------------------|------------------|-------|---|------|--|------|-----------------|------|-------------------------|-------|-------------------------|-------|
| | | | Dropout Voltage (I _{OUT} =30mA) | | Dropout Voltage (I _{OUT} =100mA) | | Supply Current | | CE "H" Level Current | | CE "L" Level Current | |
| (V) | (V) | | (mV) | | (mV) | | (μA) | | (μA) | | (μA) | |
| V _{OUT(T)} | V _{OUT} | | Vdif1 | | Vdif2 | | I _{DD} | | I _{CEH} | | I _{CEL} | |
| | MIN. | MAX. | TYP. | MAX. | TYP. | MAX. | TYP. | MAX. | MIN. | MAX. | MIN. | MAX. |
| 3.00 | 2.940 | 3.060 | 15.0 | 23.0 | 50.0 | 75.0 | 40.5 | 67.5 | 4.00 | 12.50 | -12.50 | -4.00 |
| 3.05 | 2.989 | 3.111 | | | | | | | | | | |
| 3.10 | 3.038 | 3.162 | | | | | | | | | | |
| 3.15 | 3.087 | 3.213 | | | | | | | | | | |
| 3.20 | 3.136 | 3.264 | | | | | | | | | | |
| 3.25 | 3.185 | 3.315 | | | | | | | | | | |
| 3.30 | 3.234 | 3.366 | | | | | | | | | | |
| 3.35 | 3.283 | 3.417 | | | | | | | | | | |
| 3.40 | 3.332 | 3.468 | | | | | | | | | | |
| 3.45 | 3.381 | 3.519 | | | | | | | | | | |
| 3.50 | 3.430 | 3.570 | 15 | 23 | 50 | 75 | 41.0 | 69.0 | 4.40 | 14.00 | -14.00 | -4.40 |
| 3.55 | 3.479 | 3.621 | | | | | | | | | | |
| 3.60 | 3.528 | 3.672 | | | | | | | | | | |
| 3.65 | 3.577 | 3.723 | | | | | | | | | | |
| 3.70 | 3.626 | 3.774 | | | | | | | | | | |
| 3.75 | 3.675 | 3.825 | | | | | | | | | | |
| 3.80 | 3.724 | 3.876 | | | | | | | | | | |
| 3.85 | 3.773 | 3.927 | | | | | | | | | | |
| 3.90 | 3.822 | 3.978 | | | | | | | | | | |
| 3.95 | 3.871 | 4.029 | | | | | | | | | | |
| 4.00 | 3.920 | 4.080 | 15.0 | 23.0 | 50.0 | 75.0 | 41.5 | 70.5 | 4.85 | 15.50 | -15.50 | -4.85 |
| 4.05 | 3.969 | 4.131 | | | | | | | | | | |
| 4.10 | 4.018 | 4.182 | | | | | | | | | | |
| 4.15 | 4.067 | 4.233 | | | | | | | | | | |
| 4.20 | 4.116 | 4.284 | | | | | | | | | | |
| 4.25 | 4.165 | 4.335 | | | | | | | | | | |
| 4.30 | 4.214 | 4.386 | | | | | | | | | | |
| 4.30 | 4.214 | 4.386 | | | | | | | | | | |
| 4.40 | 4.312 | 4.488 | | | | | | | | | | |
| 4.45 | 4.361 | 4.539 | | | | | | | | | | |
| 4.50 | 4.410 | 4.590 | | | | | | | | | | |
| 4.55 | 4.459 | 4.641 | | | | | | | | | | |
| 4.60 | 4.508 | 4.692 | | | | | | | | | | |
| 4.65 | 4.557 | 4.743 | | | | | | | | | | |
| 4.70 | 4.606 | 4.794 | | | | | | | | | | |
| 4.75 | 4.655 | 4.845 | | | | | | | | | | |
| 4.80 | 4.704 | 4.896 | | | | | | | | | | |
| 4.85 | 4.753 | 4.947 | | | | | | | | | | |
| 4.90 | 4.802 | 4.998 | | | | | | | | | | |
| 4.95 | 4.851 | 5.049 | | | | | | | | | | |
| 5.00 | 4.900 | 5.100 | | | | | 42.0 | 72.0 | 5.30 | 17.00 | -17.00 | -5.30 |

TEST CIRCUITS

● Circuit ①

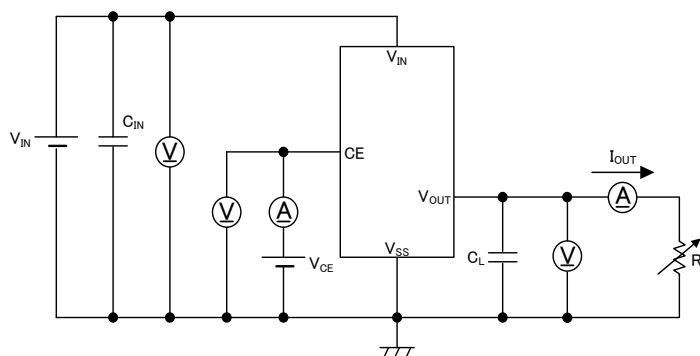

● Circuit ②



● Circuit ③



● Output Capacitor Corresponding Chart(MIN)

| OUTPUT VOLTAGE | C_L |
|----------------|-----------------------|
| 0.80V ~ 1.45V | More than 6.8 μ F |
| 1.50V ~ 1.75V | More than 4.7 μ F |
| 1.80V ~ 5.00V | More than 1.0 μ F |

OPERATIONAL EXPLANATION

<Output Voltage Regulator Control>

The voltage, divided by resistors R1 & R2, which are connected to the V_{OUT} pin is compared with the internal reference voltage by the error amplifier. The P-channel MOSFET, which is connected to the V_{OUT} pin, is then driven by the subsequent output signal. The output voltage at the V_{OUT} pin is controlled & stabilized by negative feedback. The constant current limit circuit and short circuit protection operate in relation to the level of output current.



<Low ESR Capacitor>

With the XC6210 series regulator, a stable output voltage is achievable even if low ESR capacitors are used, as a phase compensation circuit is built into the regulator. In order to ensure the effectiveness of the phase compensation, we suggest that an output capacitor (C_L) be connected as close as possible, between the output pin (V_{OUT}) and the V_{SS} pin. Please use an output capacitor (C_L) with a capacitance, based on the chart below. We also suggest an input capacitor (C_{IN}) of 1.0μF: this should be connected between V_{IN} and V_{SS} in order to stabilize input power source.

Output Capacitor Corresponding Chart(MIN)

| OUTPUT VOLTAGE RANGE | OUTPUT CAPACITOR |
|----------------------|-------------------|
| 0.80V ~ 1.45V | More than 6.8 μ F |
| 1.50V ~ 1.75V | More than 4.7 μ F |
| 1.80V ~ 5.00V | More than 1.0 μ F |

<Current Limiter, Short-Circuit Protection>

The XC6210 series regulator offers a combination of current limit and short circuit protection by means of a built-in fixed current limiter circuit and a foldback circuit. When the load current reaches the current limit level, the fixed current limiter circuit operates and output voltage drops. As a result of this drop in output voltage, the foldback circuit operates, the output voltage drops further and output current decreases. When the output pin is shorted, a current of about 50mA flows.

<CE Pin>

The IC's internal regulator circuitry can be shut down via the signal from the CE pin with the XC6210 series. In shutdown mode, output at the V_{OUT} pin will be pulled down to the V_{SS} level via R1 & R2. Options are available for the CE pin logic (See the product classification). Note that as the XC6210 series B types are 'High Active / No Pull-Down', operations will become unstable with the CE pin open. Although the CE pin is equal to an inverter input with CMOS hysteresis, with either the pull-up or pull-down options, the CE pin input current will increase when the IC is in operation.

We suggest that you use this IC with either a V_{IN} voltage or a V_{SS} voltage input at the CE pin. If this IC is used with the correct specifications for the CE pin, the IC will operate normally. However, supply current may increase as a result of through current in the IC's internal circuitry if a voltage other than V_{IN} or V_{SS} is applied.

■ NOTES ON USE

1. Please use this IC within the stated maximum ratings. For temporary, transitional voltage drop or voltage rising phenomenon, the IC is liable to malfunction should the ratings be exceeded.
2. Where wiring impedance is high, operations may become unstable due to noise and/or phase lag depending on output current. Please strengthen V_{IN} and V_{SS} wiring in particular.
3. Please wire the input capacitor (C_{IN}) and the output capacitor (C_L) as close to the IC as possible. If rapid input fluctuation or load fluctuation should occur, please increase the capacitor value such as C_{IN} or C_L more than the recommended values to stabilize the operation.
4. Torex places an importance on improving our products and its reliability. However, by any possibility, we would request user fail-safe design and post-aging treatment on system or equipment.

TYPICAL PERFORMANCE CHARACTERISTICS

(1) Output Voltage vs. Output Current

XC6210x082xx

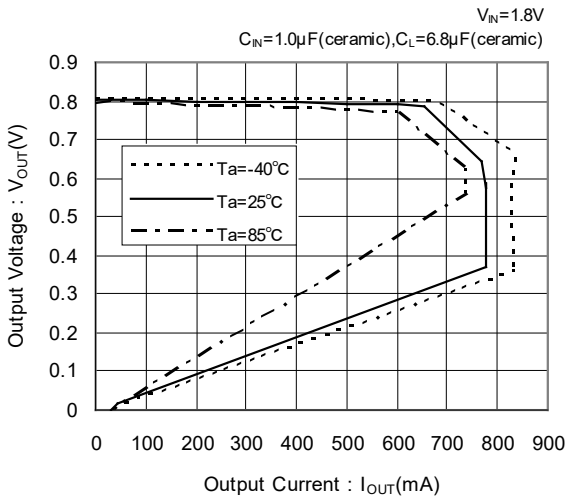

XC6210x082xx

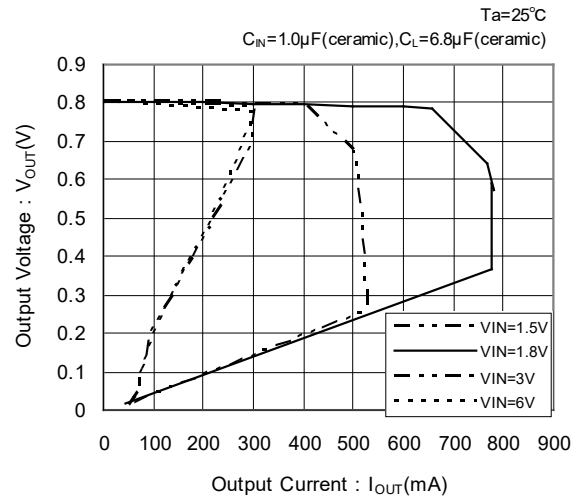

XC6210x302xx

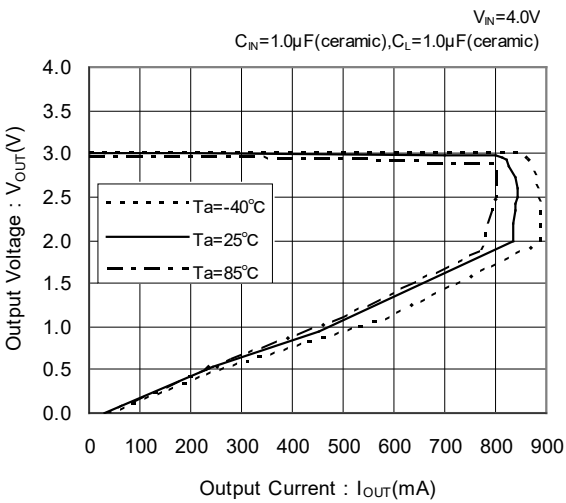

XC6210x302xx

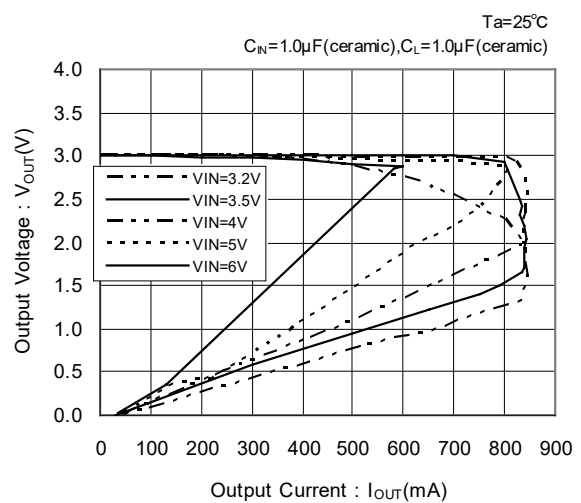

XC6210x502xx

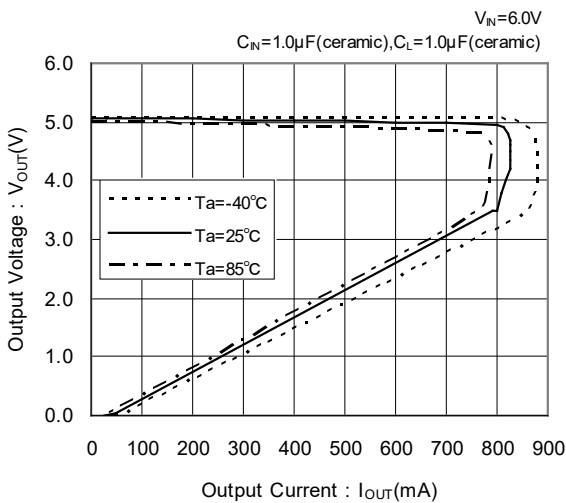

XC6210x502xx

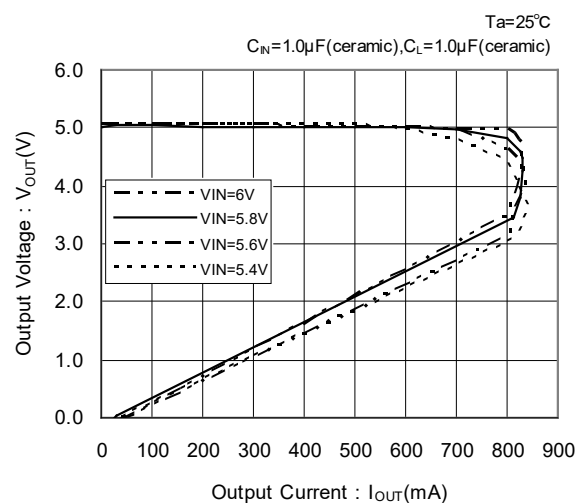

■ TYPICAL PERFORMANCE CHARACTERISTICS (Continued)

(2) Output Voltage vs. Input Voltage

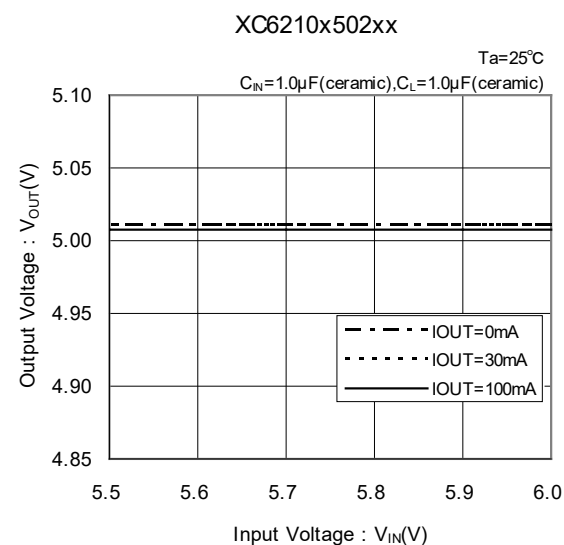
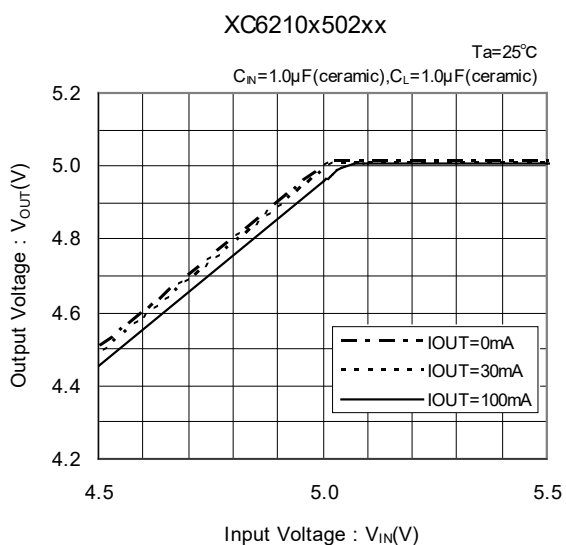
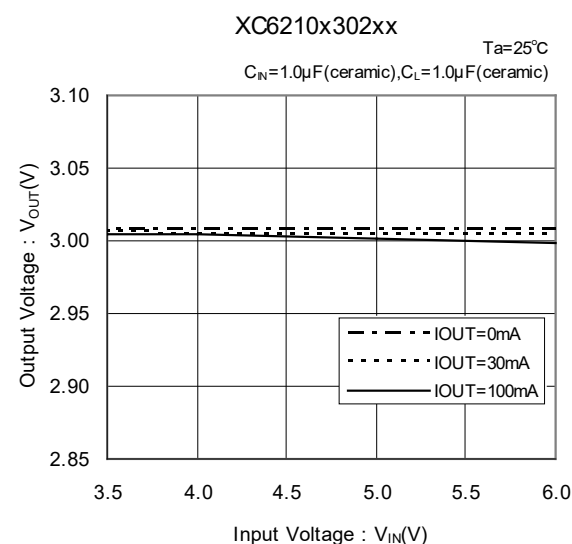
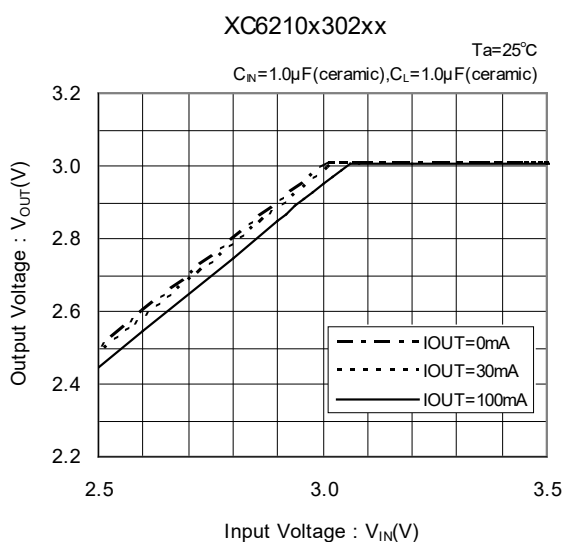
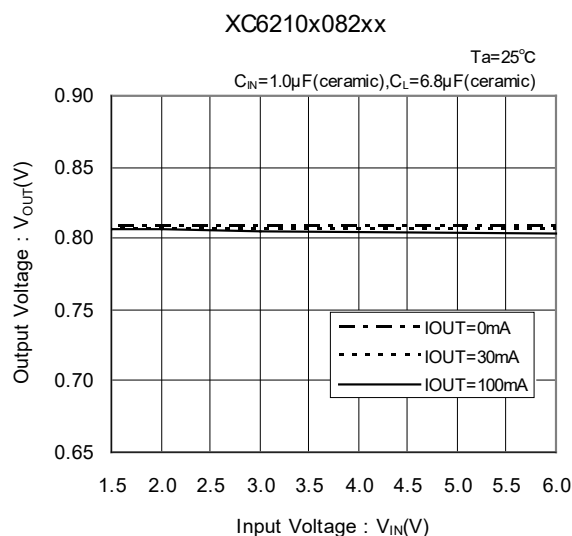
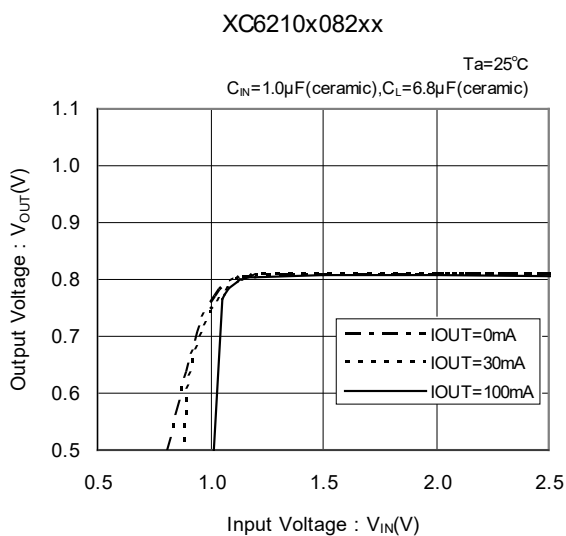

TYPICAL PERFORMANCE CHARACTERISTICS (Continued)

(3) Dropout Voltage vs. Output Current

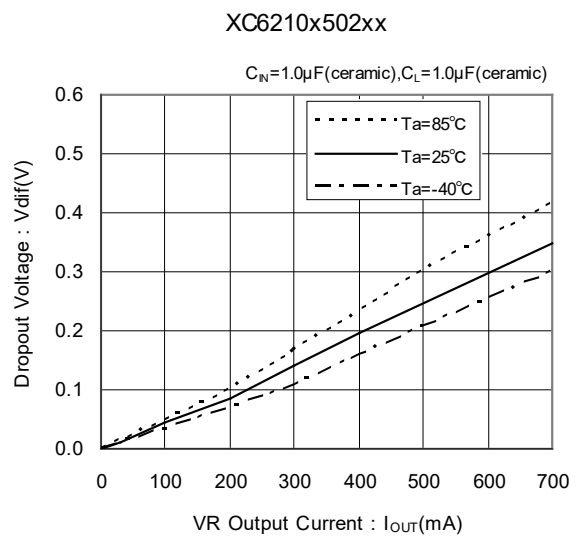
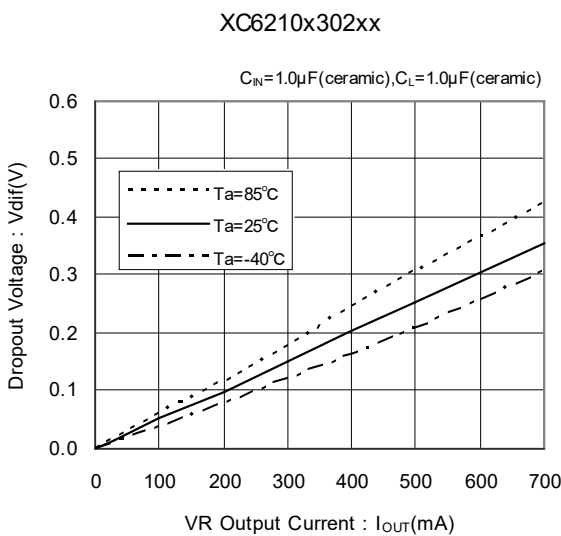
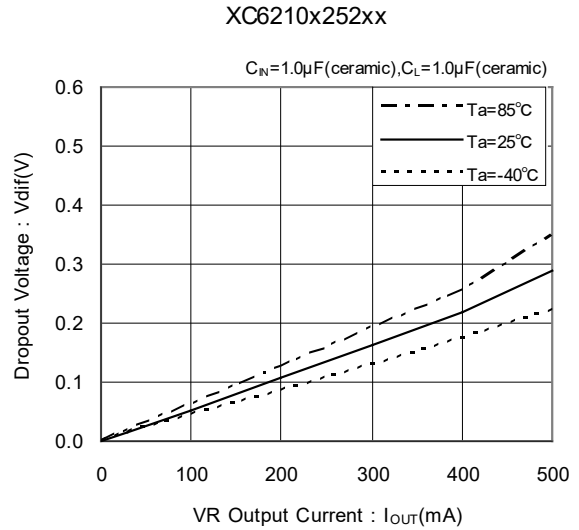
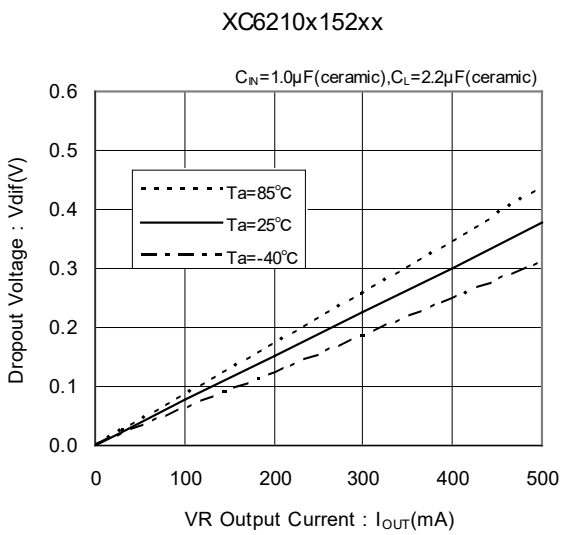
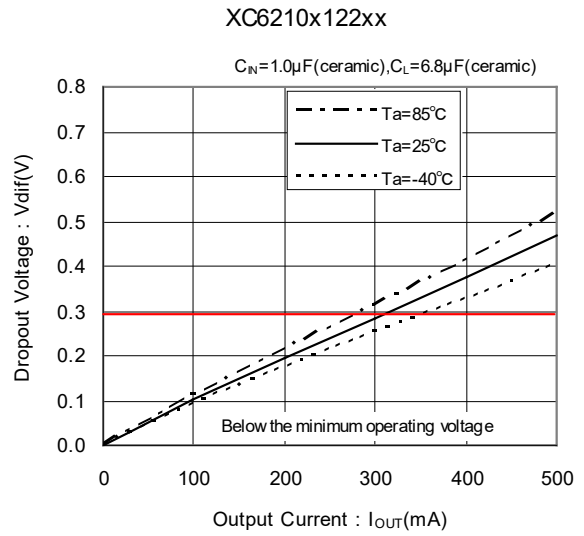
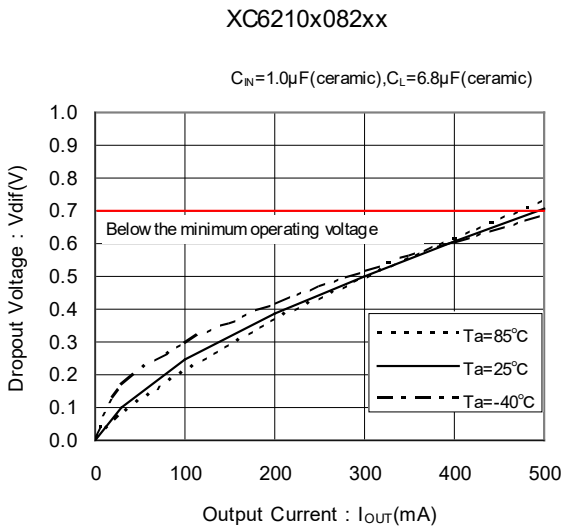

■ TYPICAL PERFORMANCE CHARACTERISTICS (Continued)

(4) Supply Current vs. Input Voltage



(5) Output Voltage vs. Ambient Temperature

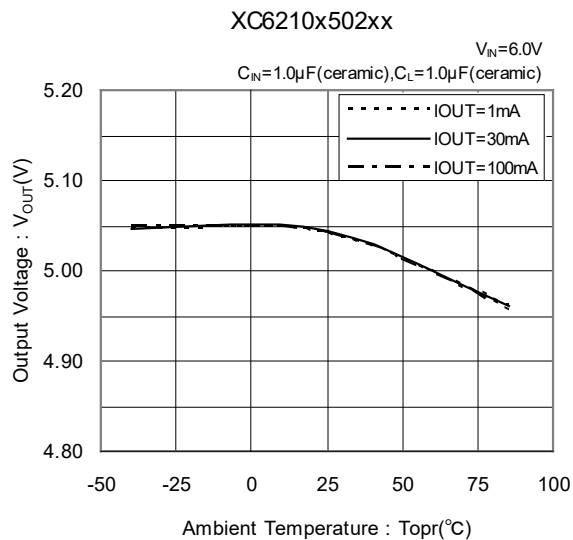
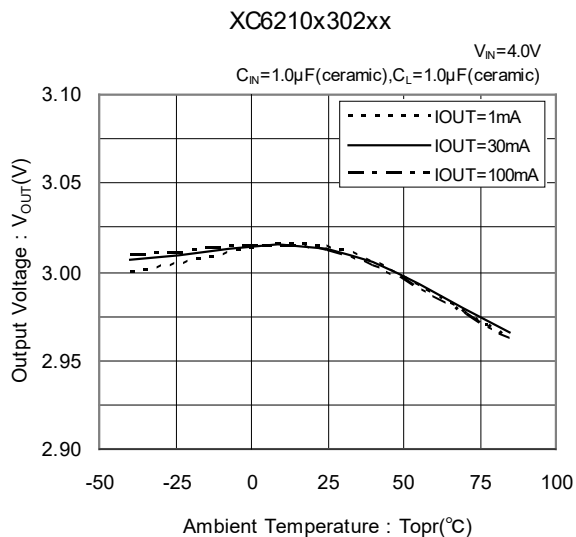
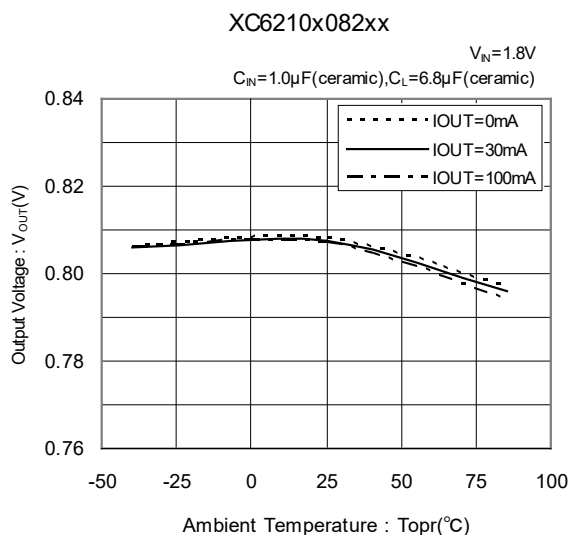
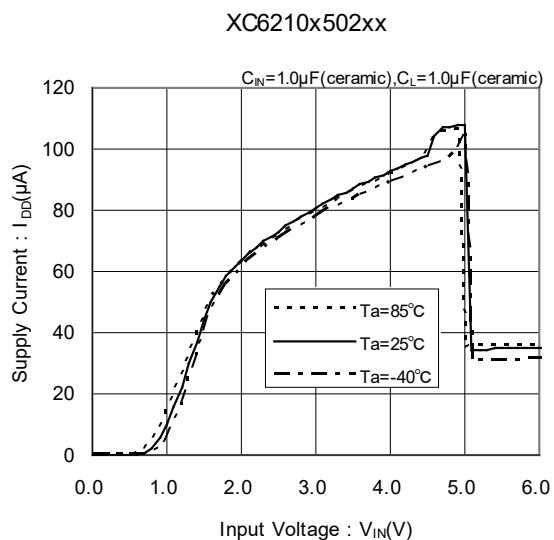

TYPICAL PERFORMANCE CHARACTERISTICS (Continued)

(6) Supply Current vs. Ambient Temperature



(7) CE Pin Threshold Voltage vs. Ambient Temperature

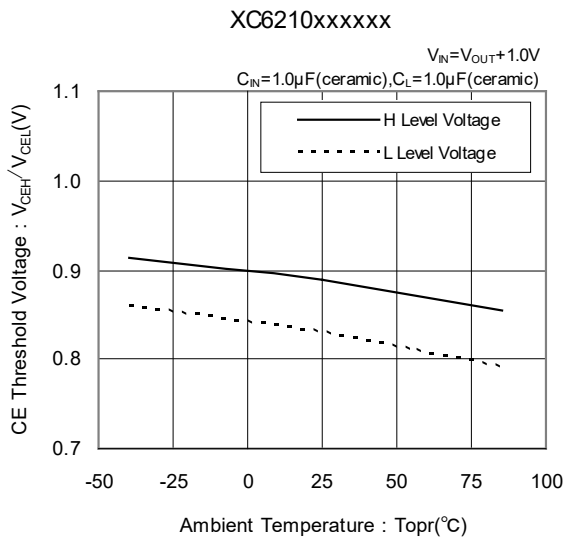

■ TYPICAL PERFORMANCE CHARACTERISTICS (Continued)

(8) Input Transient Response 1

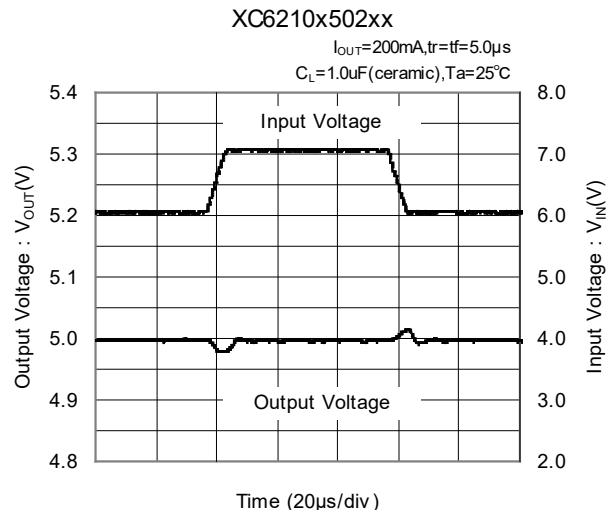
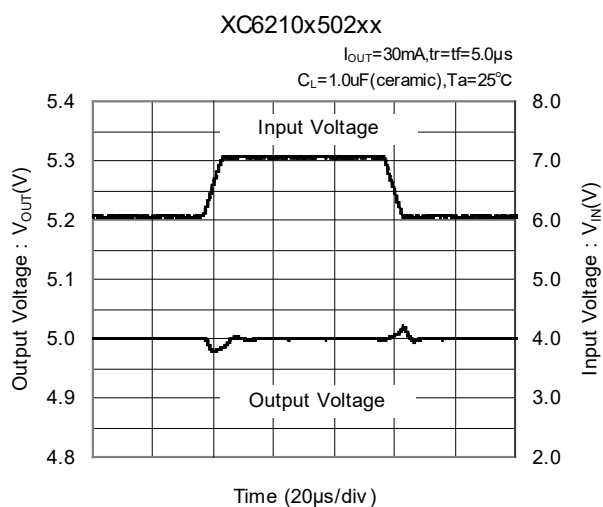

TYPICAL PERFORMANCE CHARACTERISTICS (Continued)

(9) Load Transient Response

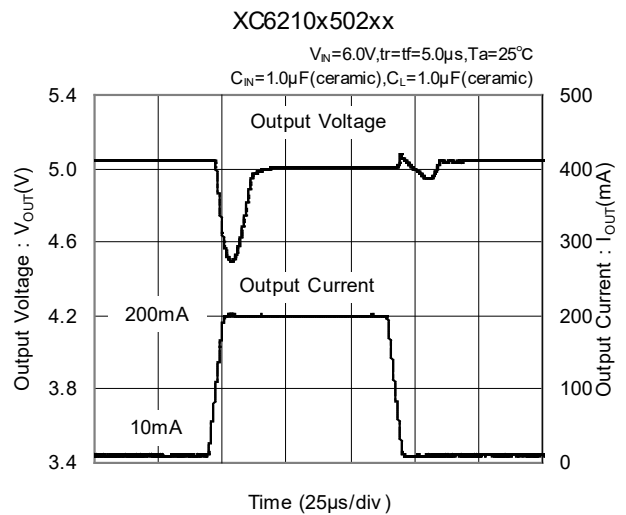
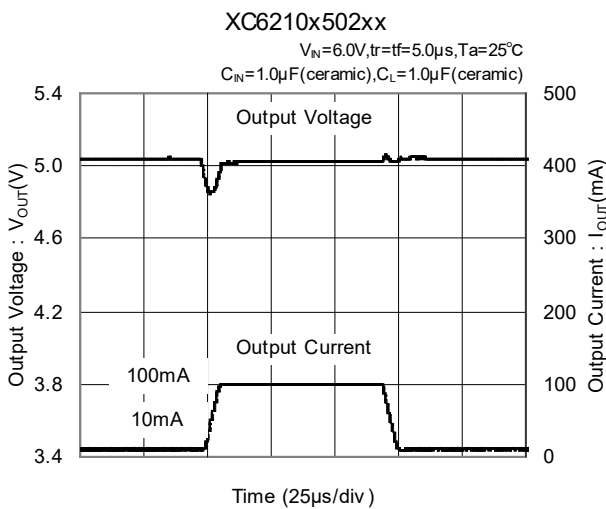
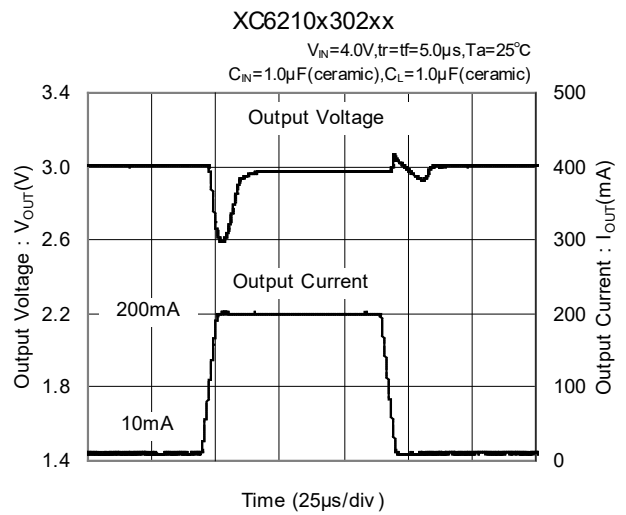
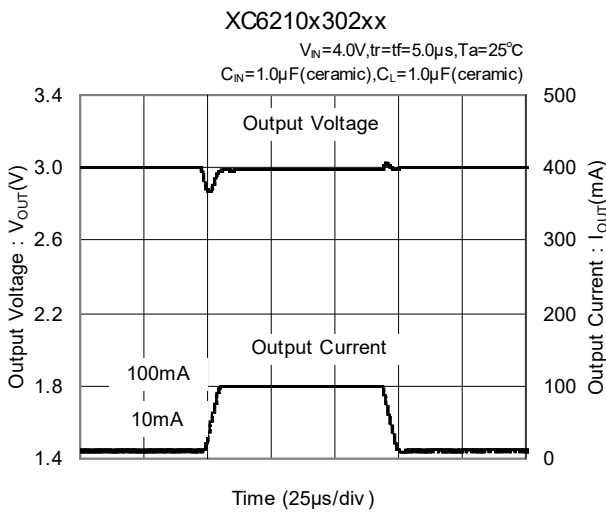
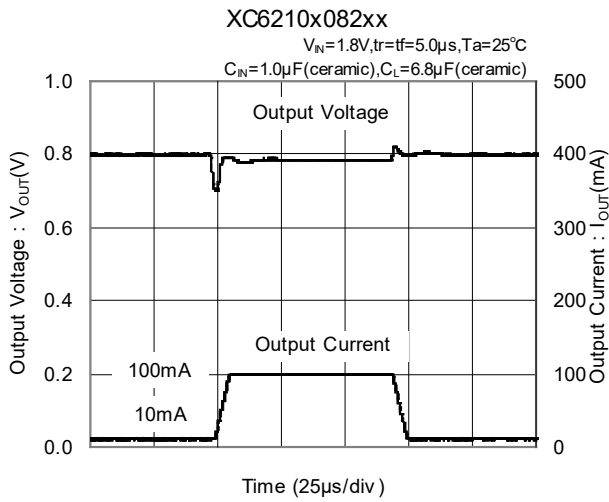

■ TYPICAL PERFORMANCE CHARACTERISTICS (Continued)

(10) Ripple Rejection Rate

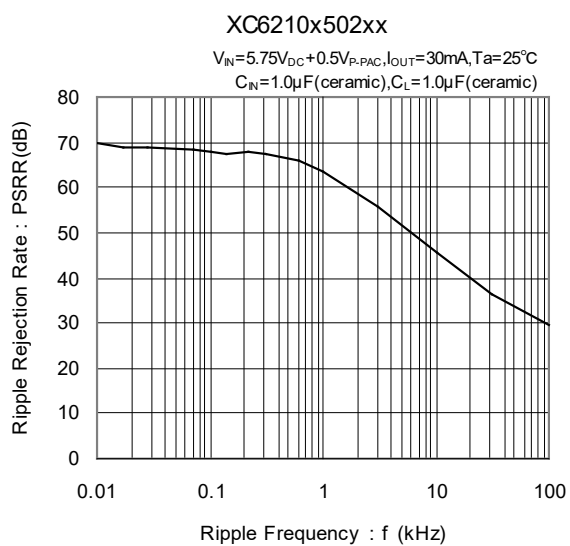
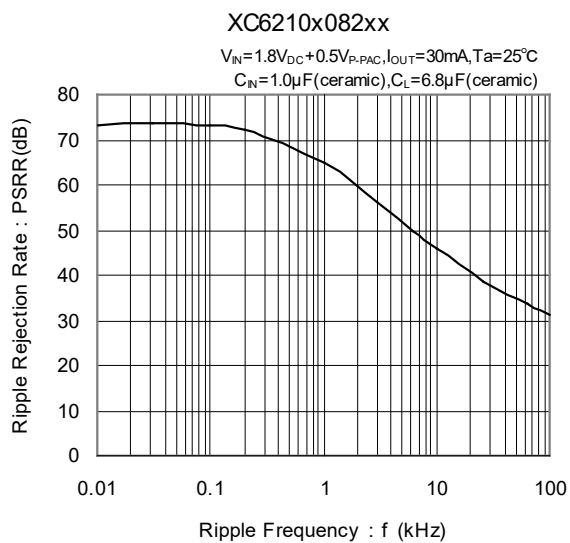

TYPICAL PERFORMANCE CHARACTERISTICS (Continued)

(11) Input Transient Response 2

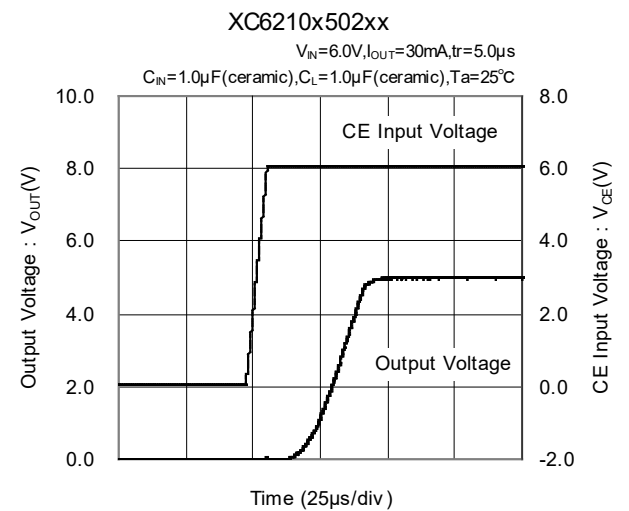
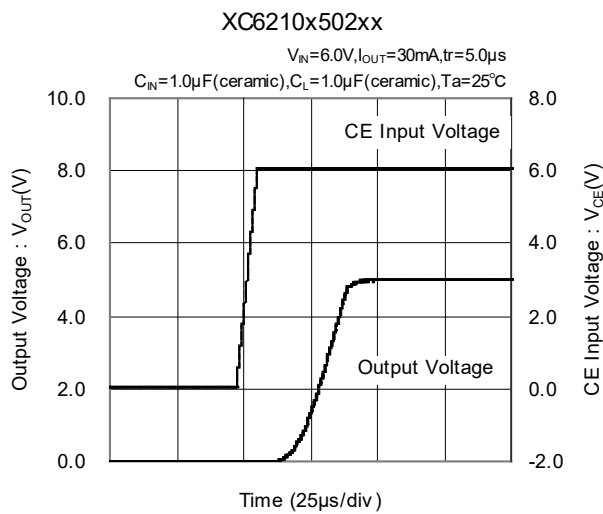
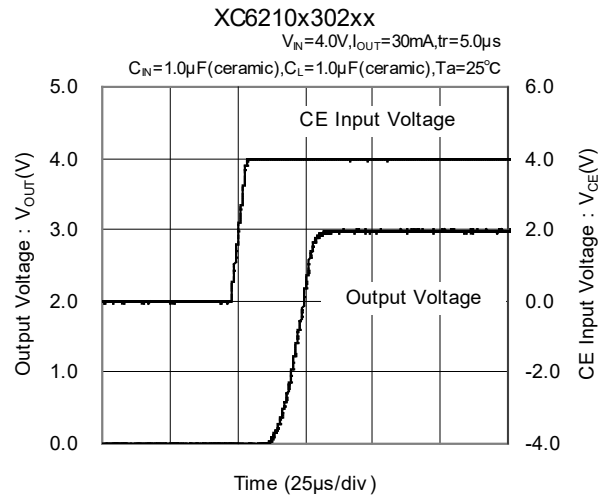
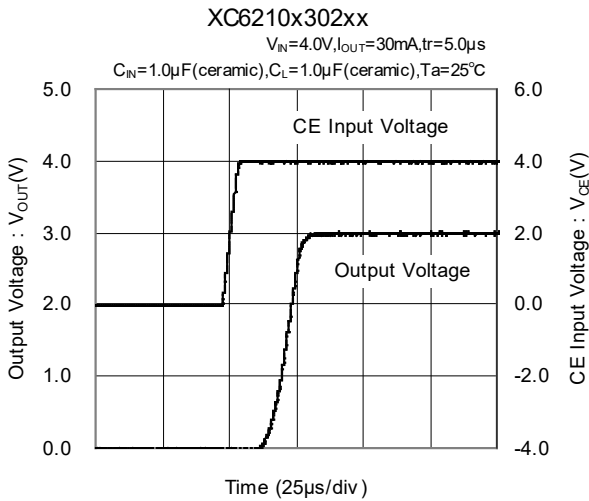
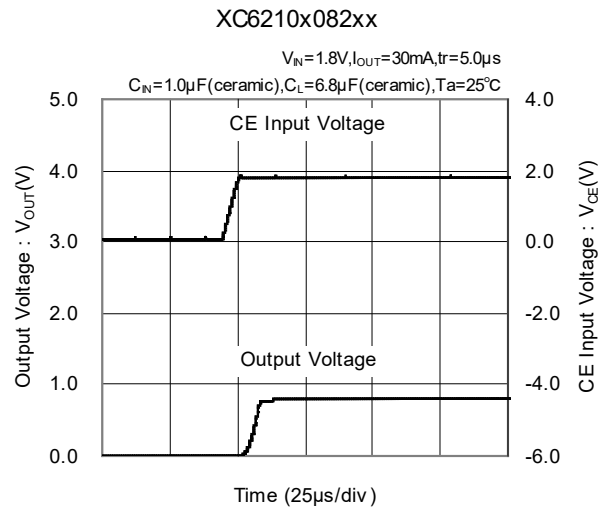
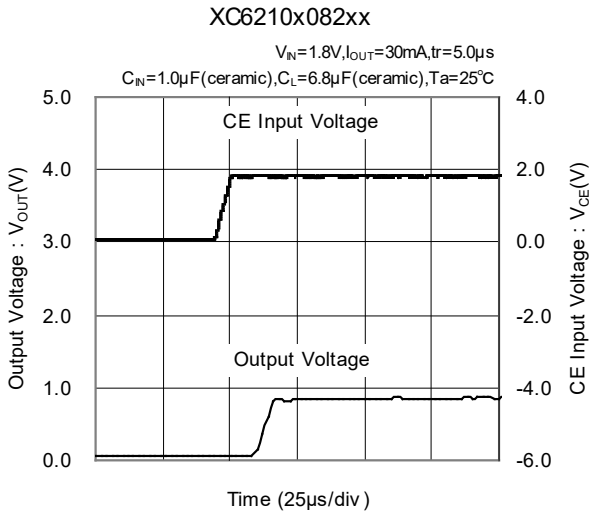

■ PACKAGING INFORMATION

For the latest package information go to, www.torexsemi.com/technical-support/packages

| PACKAGE | OUTLINE / LAND PATTERN | THERMAL CHARACTERISTICS | |
|----------|------------------------------|-------------------------|--|
| SOT-25 | SOT-25 PKG | Standard Board | SOT-25 Power Dissipation |
| | | JESD51-7 Board | |
| SOT-89-5 | SOT-89-5 PKG | Standard Board | SOT-89-5 Power Dissipation |
| | | JESD51-7 Board | |
| USP-6B | USP-6B PKG | Standard Board | USP-6B Power Dissipation |

MARKING RULE

● SOT-25

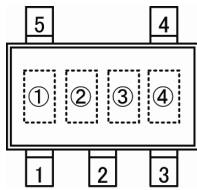

SOT-25
(TOP VIEW)

● SOT-89-5

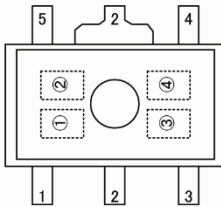

SOT-89-5
(TOP VIEW)

① represents product series

| MARK | PRODUCT SERIES |
|------|----------------|
| 0 | XC6210xxxxxx |

② represents CE function

| MARK | | | | PRODUCT SERIES |
|----------------------------|----------------------------|----------------------------|----------------------------|----------------|
| OUTPUT VOLTAGE= 0.80~3.00V | OUTPUT VOLTAGE= 3.10~5.00V | OUTPUT VOLTAGE= 0.85~3.05V | OUTPUT VOLTAGE= 3.15~4.95V | |
| V | A | E | L | XC6210Axxxxx |
| X | B | F | M | XC6210Bxxxxx |
| Y | C | H | N | XC6210Cxxxxx |
| Z | D | K | P | XC6210Dxxxxx |

③ represents output voltage

| MARK | OUTPUT VOLTAGE (V) | | | | MARK | OUTPUT VOLTAGE (V) | | | |
|------|--------------------|------|------|------|------|--------------------|------|------|------|
| | - | 3.10 | - | 3.15 | | 1.60 | 4.60 | 1.65 | 4.65 |
| 0 | - | 3.10 | - | 3.15 | F | 1.60 | 4.60 | 1.65 | 4.65 |
| 1 | - | 3.20 | - | 3.25 | H | 1.70 | 4.70 | 1.75 | 4.75 |
| 2 | - | 3.30 | - | 3.35 | K | 1.80 | 4.80 | 1.85 | 4.85 |
| 3 | - | 3.40 | - | 3.45 | L | 1.90 | 4.90 | 1.95 | 4.95 |
| 4 | - | 3.50 | - | 3.55 | M | 2.00 | 5.00 | 2.05 | - |
| 5 | - | 3.60 | - | 3.65 | N | 2.10 | - | 2.15 | - |
| 6 | - | 3.70 | - | 3.75 | P | 2.20 | - | 2.25 | - |
| 7 | 0.80 | 3.80 | 0.85 | 3.85 | R | 2.30 | - | 2.35 | - |
| 8 | 0.90 | 3.90 | 0.95 | 3.95 | S | 2.40 | - | 2.45 | - |
| 9 | 1.00 | 4.00 | 1.05 | 4.05 | T | 2.50 | - | 2.55 | - |
| A | 1.10 | 4.10 | 1.15 | 4.15 | U | 2.60 | - | 2.65 | - |
| B | 1.20 | 4.20 | 1.25 | 4.25 | V | 2.70 | - | 2.75 | - |
| C | 1.30 | 4.30 | 1.35 | 4.35 | X | 2.80 | - | 2.85 | - |
| D | 1.40 | 4.40 | 1.45 | 4.45 | Y | 2.90 | - | 2.95 | - |
| E | 1.50 | 4.50 | 1.55 | 4.55 | Z | 3.00 | - | 3.05 | - |

④ represents production lot number

0 to 9, A to Z reverse character 0 to 9, A to Z repeated (G, I, J, O, Q, W excluded)

MARKING RULE (Continued)

● USP-6B

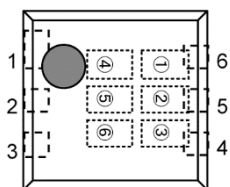

USP-6B
(TOP VIEW)

①② represents product series

| MARK | | PRODUCT SERIES |
|------|---|----------------|
| ① | ② | |
| 1 | 0 | XC6210xxxxxx |

③ represents CE Function

| MARK | TYPE | PRODUCT SERIES |
|------|---|----------------|
| A | CE High Active with pull-down resistor | XC6210AxxxDx |
| B | CE High Active with no pull-down resistor | XC6210BxxxDx |
| C | CE Low Active with pull-up resistor | XC6210CxxxDx |
| D | CE Low Active with no pull-up resistor | XC6210DxxxDx |

④ represents the integer number of output voltage
ex.)

| MARK | VOLTAGE (V) | PRODUCT SERIES |
|------|-------------|----------------|
| 3 | 3.x | XC6210x3xxDx |
| 5 | 5.x | XC6210x5xxDx |

⑤ represents the decimal point of output voltage

| MARK | VOLTAGE (V) | PRODUCT SERIES | MARK | VOLTAGE (V) | PRODUCT SERIES |
|------|-------------|----------------|------|-------------|----------------|
| 0 | x.00 | XC6210xx02Dx | A | x.05 | XC6210xx0ADx |
| 1 | x.10 | XC6210xx12Dx | B | x.15 | XC6210xx1ADx |
| 2 | x.20 | XC6210xx22Dx | C | x.25 | XC6210xx2ADx |
| 3 | x.30 | XC6210xx32Dx | D | x.35 | XC6210xx3ADx |
| 4 | x.40 | XC6210xx42Dx | E | x.45 | XC6210xx4ADx |
| 5 | x.50 | XC6210xx52Dx | F | x.55 | XC6210xx5ADx |
| 6 | x.60 | XC6210xx62Dx | H | x.65 | XC6210xx6ADx |
| 7 | x.70 | XC6210xx72Dx | K | x.75 | XC6210xx7ADx |
| 8 | x.80 | XC6210xx82Dx | L | x.85 | XC6210xx8ADx |
| 9 | x.90 | XC6210xx92Dx | M | x.95 | XC6210xx9ADx |

⑥ represents production lot number
0 to 9, A to Z repeated (G, I, J, O, Q, W, excluded)
Note: No character inversion used.

1. The product and product specifications contained herein are subject to change without notice to improve performance characteristics. Consult us, or our representatives before use, to confirm that the information in this datasheet is up to date.
2. The information in this datasheet is intended to illustrate the operation and characteristics of our products. We neither make warranties or representations with respect to the accuracy or completeness of the information contained in this datasheet nor grant any license to any intellectual property rights of ours or any third party concerning with the information in this datasheet.
3. Applicable export control laws and regulations should be complied and the procedures required by such laws and regulations should also be followed, when the product or any information contained in this datasheet is exported.
4. The product is neither intended nor warranted for use in equipment of systems which require extremely high levels of quality and/or reliability and/or a malfunction or failure which may cause loss of human life, bodily injury, serious property damage including but not limited to devices or equipment used in 1) nuclear facilities, 2) aerospace industry, 3) medical facilities, 4) automobile industry and other transportation industry and 5) safety devices and safety equipment to control combustions and explosions. Do not use the product for the above use unless agreed by us in writing in advance.
5. Although we make continuous efforts to improve the quality and reliability of our products; nevertheless Semiconductors are likely to fail with a certain probability. So in order to prevent personal injury and/or property damage resulting from such failure, customers are required to incorporate adequate safety measures in their designs, such as system fail safes, redundancy, and fire prevention features.
6. Our products are not designed to be Radiation-resistant.
7. Please use the product listed in this datasheet within the specified ranges.
8. We assume no responsibility for damage or loss due to abnormal use.
9. All rights reserved. No part of this datasheet may be copied or reproduced unless agreed by Torex Semiconductor Ltd in writing in advance.

TOREX SEMICONDUCTOR LTD.

X-ON Electronics

Largest Supplier of Electrical and Electronic Components

Click to view similar products for [LDO Voltage Regulators](#) category:

Click to view products by [Torex Semiconductor](#) manufacturer:

Other Similar products are found below :

[L79M05TL-E](#) [PT7M8202B12TA5EX](#) [TCR3DF185,LM\(CT](#) [TCR3DF24,LM\(CT](#) [TCR3DF285,LM\(CT](#) [TCR3DF31,LM\(CT](#)
[TCR3DF45,LM\(CT](#) [MP2013GQ-33-Z](#) [059985X](#) [NCP4687DH15T1G](#) [701326R](#) [TCR2EN28,LF\(S](#) [NCV8170AXV250T2G](#)
[TCR3DF27,LM\(CT](#) [TCR3DF19,LM\(CT](#) [TCR3DF125,LM\(CT](#) [TCR2EN18,LF\(S](#) [AP2112R5A-3.3TRG1](#) [AP7315-25W5-7](#)
[IFX30081LDVGRNXUMA1](#) [AP2111H-1.2TRG1](#) [ZLDO1117QK50TC](#) [AZ1117ID-ADJTRG1](#) [TCR3DG12,LF](#) [MIC5514-3.3YMT-T5](#)
[MIC5512-1.2YMT-T5](#) [MIC5317-2.8YM5-T5](#) [SCD7912BTG](#) [NCP154MX180270TAG](#) [SCD33269T-5.0G](#) [NCV8170BMX330TCG](#)
[NCV8170AMX120TCG](#) [NCP706ABMX300TAG](#) [NCP153MX330180TCG](#) [NCP114BMX075TCG](#) [MC33269T-3.5G](#) [CAT6243-ADJCMT5T](#)
[TCR3DG33,LF](#) [AP2127N-1.0TRG1](#) [BD3021HFP-MTR](#) [TCR4DG35,LF](#) [LT1117CST-3.3](#) [TAR5S15U\(TE85L,F\)](#) [TAR5S18U\(TE85L,F\)](#)
[TCR3UG19A,LF](#) [TCR4DG105,LF](#) [NCV8170AMX360TCG](#) [MIC94310-NYMT-T5](#) [NCV4266-2CST33T3G](#) [NCV8186BMN175TAG](#)