

10V Input, 500mA, High Speed LDO Regulators

■ GENERAL DESCRIPTION

XC6231 series are highly precise, low noise, positive voltage LDO regulators which features high ripple rejection and low dropout. Output voltage is selectable within a range of 0.9V ~ 5.5V.

The series is also compatible with low ESR ceramic capacitors which give added output stability.

This stability can be maintained even during load fluctuations due to the excellent transient response of the series.

The current limiter's foldback circuit operates as a short-circuit protection as well as the output current limiter for the output pin.

■ APPLICATIONS

- Reference voltage sources
- Multi-function power supplies

■ FEATURES

Maximum Output Current	: 500mA (600mA limit) ($2.5V \leq V_{OUT} \leq 5.5V$)
Dropout Voltage	: 200mV @ 100mA
Operating Voltage Range	: 2.0V ~ 10.0V
Output Voltage Range	: 0.9V ~ 5.5V (0.1V increments)
Output Voltage Accuracy	: $\pm 2\%$
Temperature Coefficient	: $\pm 100\text{ppm}/^\circ\text{C}$ (TYP.)
Low Power Consumption	: 35 μA (TYP.)
High Ripple Rejection	: 65dB @ 10kHz
Protection circuits	: Current Limiting
Low ESR Capacitor	: Ceramic Capacitor Compatible
Operating Ambient Temperature	: $-40^\circ\text{C} \sim +85^\circ\text{C}$
Package	: SOT-89-5
Environmentally Friendly	: EU RoHS Compliant, Pb Free

■ TYPICAL APPLICATION CIRCUITS

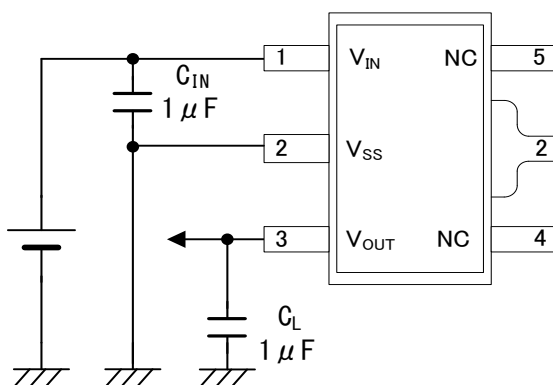

■ TYPICAL PERFORMANCE CHARACTERISTICS

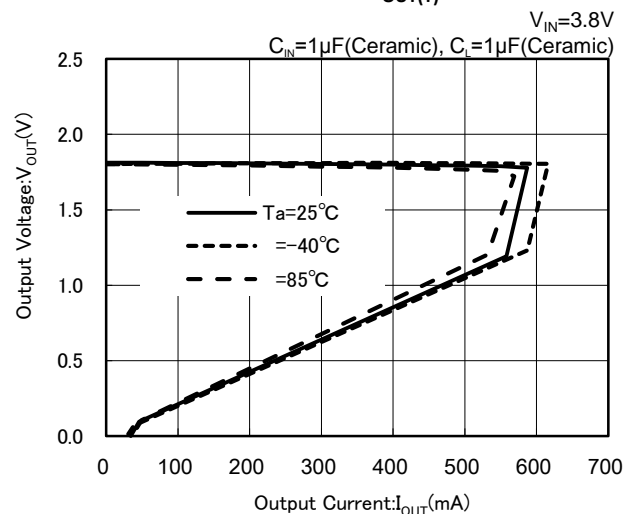
XC6231A182PR-G ($V_{OUT(T)}=1.8V$)

■ BLOCK DIAGRAM

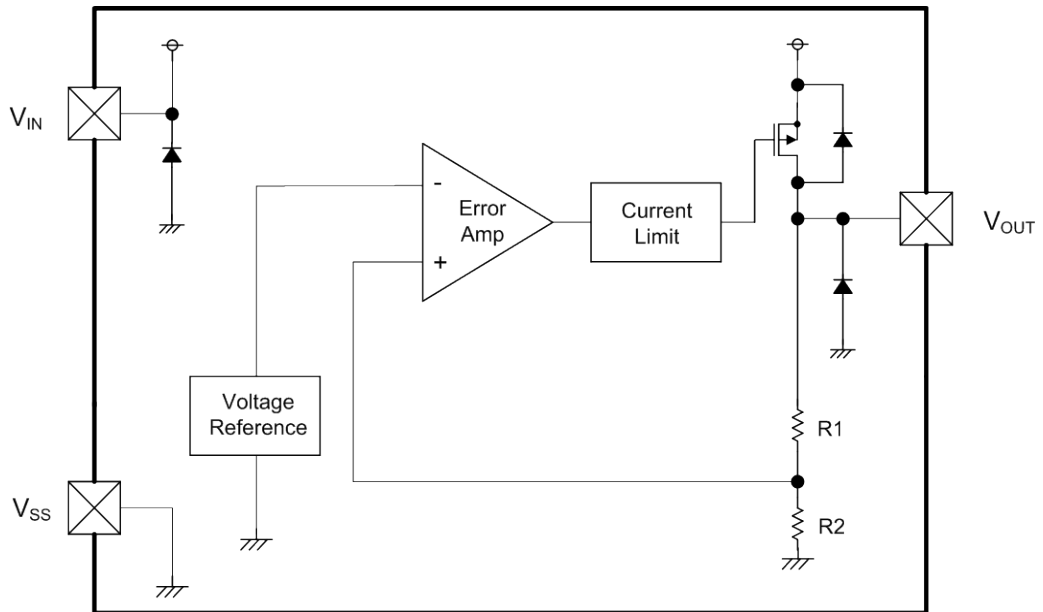

* Diodes inside the circuit are an ESD protection diode and parasitic diodes.

■ PRODUCT CLASSIFICATION

● Ordering Information

XC6231A①②③④⑤-⑥

DESIGNATOR	ITEM	SYMBOL	DESCRIPTION
①②	Output Voltage	09~55	0.9V ~ 5.5V (100mV step)
③	Output Voltage Accuracy	2	±2%
④⑤-⑥ ^(*)	Package (Order Unit)	PR-G	SOT-89-5 (1,000pcs/Reel)

^(*) The "G" suffix denotes Halogen and Antimony free as well as being fully EU RoHS compliant.

■ PIN CONFIGURATION

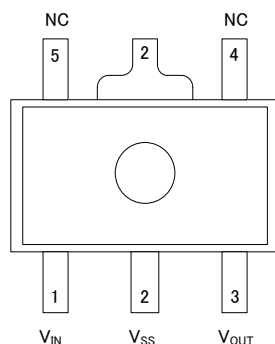

SOT-89-5
(TOP VIEW)

■ PIN ASSIGNMENT

PIN NUMBER SOT-89-5	PIN NAME	FUNCTIONS
1	V _{IN}	Power Supply Input
2	V _{SS}	Ground
3	V _{OUT}	Output
4,5	NC	No connection

■ ABSOLUTE MAXIMUM RATINGS

T_a=25°C

PARAMETER	SYMBOL	RATINGS	UNITS
Input Voltage	V _{IN}	-0.3 ~ +12.0	V
Output Current	I _{OUT}	700 ^{(*)1}	mA
Output Voltage	V _{OUT}	- 0.3 ~ V _{IN} + 0.3 or +12.0 ^{(*)2}	V
Power Dissipation	SOT-89-5	P _d	1300 (40mm × 40mm Standard board) ^{(*)3}
			1750 (JE5D51-7 board) ^{(*)3}
Operating Ambient Temperature	T _{opr}	-40 ~ +85	°C
Storage Temperature	T _{stg}	-55 ~ +125	°C

All voltage ratings are relative to V_{SS}

^{(*)1} Use with I_{OUT} less than P_d/(V_{IN}-V_{OUT})

^{(*)2} The maximum value should be either V_{IN} + 0.3 or +12.0 in the lowest

^{(*)3} The power dissipation figure shown is PCB mounted and is for reference only.

The mounting condition is please refer to PACKAGING INFORMATION.

Ta=25°C

PARAMETER	SYMBOL	CONDITIONS	MIN.	TYP.	MAX.	UNIT	CIRCUIT
Output Voltage	$V_{OUT(E)}$	$I_{OUT}=30mA$	$\times 0.98$	$V_{OUT(T)}$	$\times 1.02$	V	①
Maximum Output Current	I_{OUTMAX}	$V_{OUT(T)} \geq 2.5V, V_{IN}=V_{OUT(T)}+2.0V$	500	-	-	mA	①
		$V_{OUT(T)} < 2.5V, V_{IN}=V_{OUT(T)}+2.0V$	400	-	-		
Load Regulation	ΔV_{OUT}	$1mA \leq I_{OUT} \leq 100mA$		15	50	mV	①
Dropout Voltage1	V_{dif1}	$I_{OUT}=30mA$	-	E-1		mV	①
Dropout Voltage2	V_{dif2}	$I_{OUT}=100mA$	-	E-2			
Supply Current	I_{DD}	$V_{IN}=V_{OUT(T)}+1.0V$ $V_{OUT(T)} \leq 0.90V \nmid V_{IN}=2.0V$	-	35	70	μA	②
Line Regulation	$\frac{\Delta V_{OUT}}{(\Delta V_{IN} \cdot V_{OUT})}$	$V_{OUT(T)}+1.0V \leq V_{IN} \leq 10.0V$ $V_{OUT(T)} \leq 0.90V, V_{IN} \geq 2.0V \sim$ $I_{OUT}=30mA,$ $V_{OUT(T)} \leq 1.75V, I_{OUT}=10mA$	-	0.01	0.20	%/V	①
Input Voltage	V_{IN}		2		10	V	-
Output Temperature Characteristics	$\frac{\Delta V_{OUT}}{(\Delta T_{OP} \cdot V_{OUT})}$	$I_{OUT}=30mA$ $-40^{\circ}C \leq T_{OP} \leq 85^{\circ}C$	-	± 100	-	ppm/ $^{\circ}C$	①
Power Supply Rejection Rate	PSRR	$V_{IN}=[V_{OUT(T)}+1.0]V+0.5V_{P-PAC}$ $V_{OUT(T)} \leq 1.25V$ $V_{IN}=2.25+0.5V_{P-PAC}$ $I_{OUT}=50mA, f=10kHz$	-	65	-	dB	③
Current Limit	I_{lim}	$V_{OUT(T)} \geq 2.5V, V_{IN}=V_{OUT(T)}+2.0V$	500	600	-	mA	①
		$V_{OUT(T)} < 2.5V, V_{IN}=V_{OUT(T)}+2.0V$	-	600	-		
Short Circuit Current	I_{shot}	$V_{IN}=V_{OUT(T)}+2.0V$ $V_{OUT} \leq 1.5, V_{IN}=3.5V$	-	30	-	mA	①

NOTE

(¹) Unless otherwise stated, $V_{IN}=V_{ROUT(T)}+1.0V$. however $V_{OUT} \leq 0.9V : V_{IN}=2.0V$

(²) $V_{OUT(T)}$: Set output voltage value

(³) $V_{OUT(E)}$: Effective output voltage value.

(The output voltage when an amply stabilized " $V_{OUT(T)}+1.0V$ " is provided at the V_{IN} pin while maintaining a certain I_{OUT} Value)

(⁴) V_{dif} is defined as follows: $V_{dif}=\{V_{IN1}-V_{OUT1}\}$.

- V_{OUT1} : 98% of output voltage when V_{IN} is input after stabilizing sufficiently at each I_{OUT} .
- V_{IN1} : As input voltage is gradually reduced, the input voltage at which V_{OUT1} is output.

■ ELECTRICAL CHARACTERISTICS

SYMBOL	E-0		E-1		E-2	
	Output Voltage (V)		Dropout Voltage1 I _{OUT} =30mA (mV)		Dropout Voltage2 I _{OUT} =100mA (mV)	
	V _{OUT}		V _{dif1}		V _{dif2}	
V _{OUT(T)}	MIN	MAX	TYP	MAX	TYP	MAX
0.90	0.870	0.930	1100	1110	1150	1200
1.00	0.970	1.030	1000	1010	1050	1100
1.10	1.070	1.130	900	910	950	1000
1.20	1.170	1.230	800	810	850	900
1.30	1.270	1.330	700	710	750	800
1.40	1.370	1.430	600	610	650	700
1.50	1.470	1.530	500	510	550	600
1.60	1.568	1.632	400	410	500	550
1.70	1.666	1.734	300	310	400	450
1.80	1.764	1.836	200	300	300	400
1.90	1.862	1.938	120	150	280	380
2.00	1.960	2.040	80	120	240	350
2.10	2.058	2.142	80	120	240	330
2.20	2.156	2.244	80	120	240	330
2.30	2.254	2.346	80	120	240	310
2.40	2.352	2.448	80	120	240	310
2.50	2.450	2.550	70	100	220	290
2.60	2.548	2.652	70	100	220	290
2.70	2.646	2.754	70	100	220	290
2.80	2.744	2.856	70	100	220	270
2.90	2.842	2.958	70	100	220	270
3.00	2.940	3.060	60	90	200	270
3.10	3.038	3.162	60	90	200	250
3.20	3.136	3.264	60	90	200	250
3.30	3.234	3.366	60	90	200	250
3.40	3.332	3.468	60	90	200	250
3.50	3.430	3.570	60	90	200	250
3.60	3.528	3.672	60	90	200	250
3.70	3.626	3.774	60	90	200	250
3.80	3.724	3.876	60	90	200	250
3.90	3.822	3.978	60	90	200	250
4.00	3.920	4.080	60	80	180	230
4.10	4.018	4.182	60	80	180	230
4.20	4.116	4.284	60	80	180	230
4.30	4.214	4.386	60	80	180	230
4.40	4.312	4.488	60	80	180	230
4.50	4.410	4.590	60	80	180	230
4.60	4.508	4.692	60	80	180	230
4.70	4.606	4.794	60	80	180	230
4.80	4.704	4.896	60	80	180	230
4.90	4.802	4.998	60	80	180	230
5.00	4.900	5.100	50	70	160	210
5.10	4.998	5.202	50	70	160	210
5.20	5.096	5.304	50	70	160	210
5.30	5.194	5.406	50	70	160	210
5.40	5.292	5.508	50	70	160	210
5.50	5.390	5.610	50	70	160	210

TEST CIRCUITS

Circuit ①

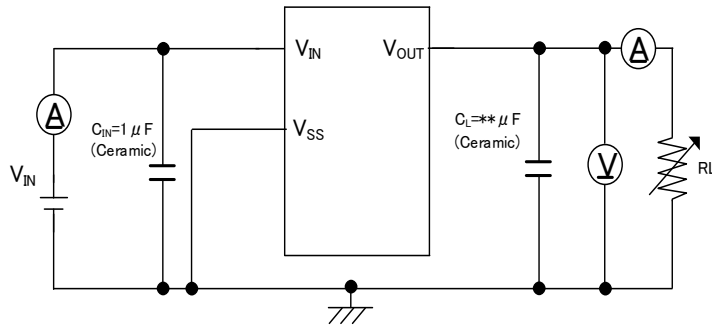

Circuit ②

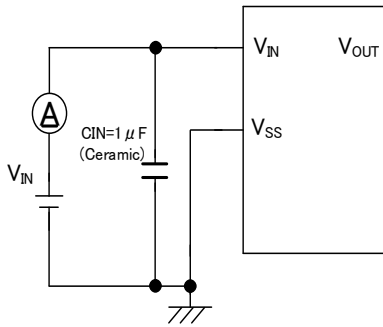

Circuit ③

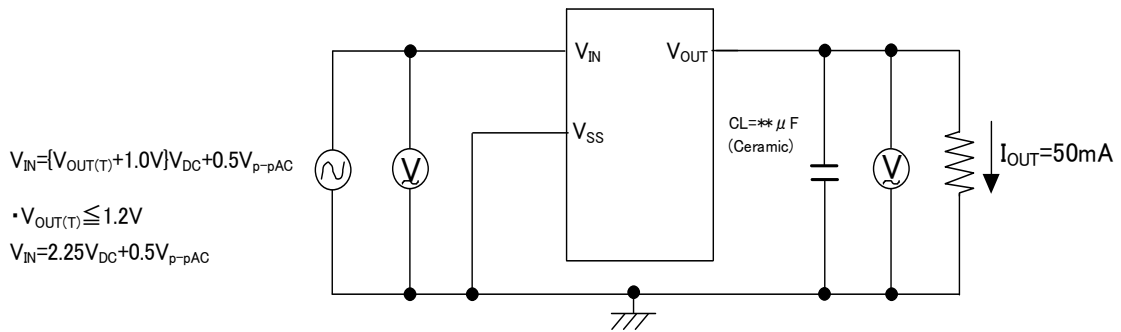

* Output Capacitor (C_L) Corresponding Chart

V _{OUT}	C _L
0.9 ~ 1.2V	More than equal to 4.7μF
1.3 ~ 1.7V	More than equal to 2.2μF
1.8 ~ 5.5V	More than equal to 1.0μF

■ OPERATIONAL EXPLANATION

The XC6231 series controls the output voltage, divided by resistors R1 & R2 which are connected to the V_{OUT} pin is compared with the internal reference voltage by the error amplifier.

The P-channel MOSFET connected to the V_{OUT} pin, is then driven by the subsequent output signal. The output voltage at the V_{OUT} pin is controlled & stabilized by negative feedback.

The current limit circuit and short protect circuit operate in relation to the level of output current.

<Low ESR Capacitors>

With the XC6231series regulator, a stable output voltage is achievable even if low ESR capacitors are used, as a phase compensation circuit is built-in to the regulator. In order to ensure the effectiveness of the phase compensation, we suggest that an output capacitor (C_L) be connected as close as possible, between the output pin (V_{OUT}) and the V_{SS} pin. Please use an output capacitor (C_L) with a capacitance, based on the chart below. We also suggest an input capacitor (C_{IN}) of 1μF : this should be connected between V_{IN} and V_{SS} in order to stabilize input power source.

Output Capacitor Corresponding Chart

V _{OUT}	C _L
0.9 ~ 1.2V	More than equal to 4.7μF
1.3 ~ 1.7V	More than equal to 2.2μF
1.8 ~ 5.5V	More than equal to 1.0μF

<Current Limiter, Short-Circuit Protection>

XC6231series regulator offers a combination of current limit and circuit protection by means of a built-in fixed current limiter circuit and a foldback circuit. When the load current reaches the current limit level, the fixed current limiter circuit operates and output voltage drops. As a result of this drop in output voltage, the foldback circuit operates, the output voltage drops further and output current decreases. When the output pin is shorted, a current of about 50mA flows.

■ NOTES ON USE

- 1) Please use this IC within the stated absolute maximum ratings. The IC is liable to malfunction should the ratings be exceeded.
- 2) Where wiring impedance is high, operations may become unstable due to noise and/or phase lag depending on output current. Please strengthen V_{IN} and V_{SS} wiring in particular.
- 3) Please wire the input capacitor (C_{IN}) and the output capacitor (C_L) as close to the IC as possible. Should rapid input fluctuation or load fluctuation occur, please increase the capacitor value such as C_{IN} or C_L to stabilize the operation.
- 4) Torex places an importance on improving our products and its reliability. However, by any possibility, we would request user fail-safe design and post-aging treatment on system or equipment.

TYPICAL PERFORMANCE CHARACTERISTICS

(1) Output Voltage vs. Output Current

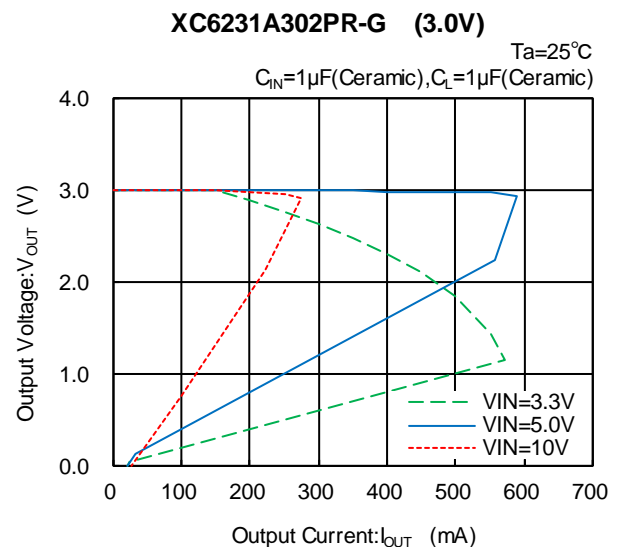
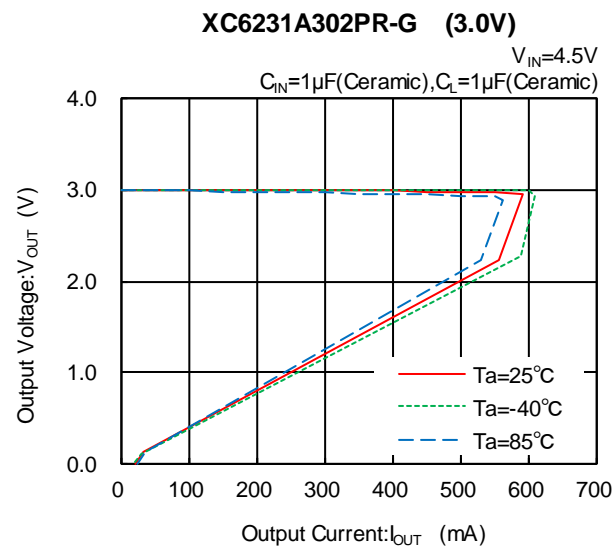
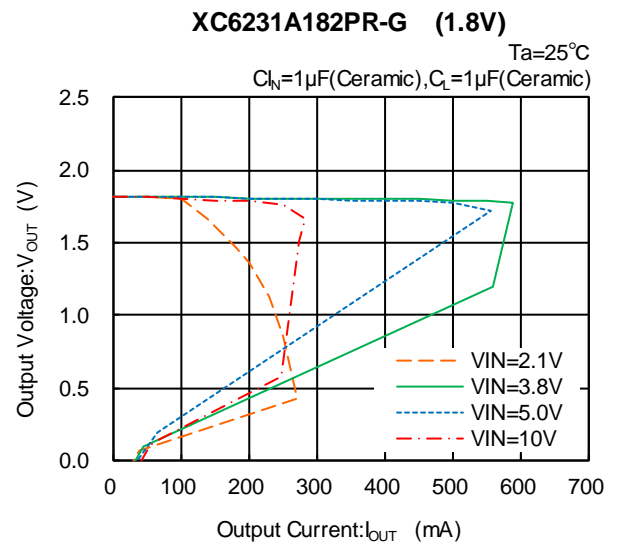
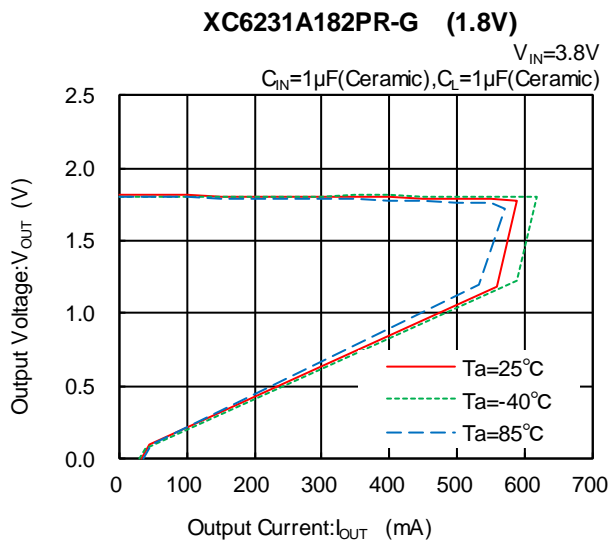
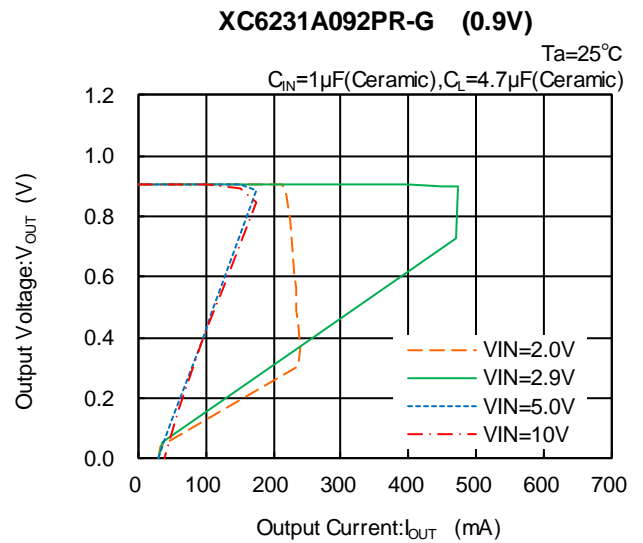
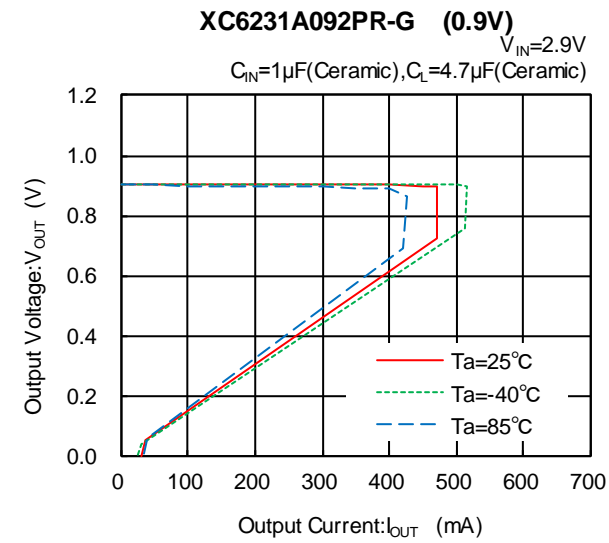

■ TYPICAL PERFORMANCE CHARACTERISTICS

(1) Output Voltage vs. Output Current (Continued)

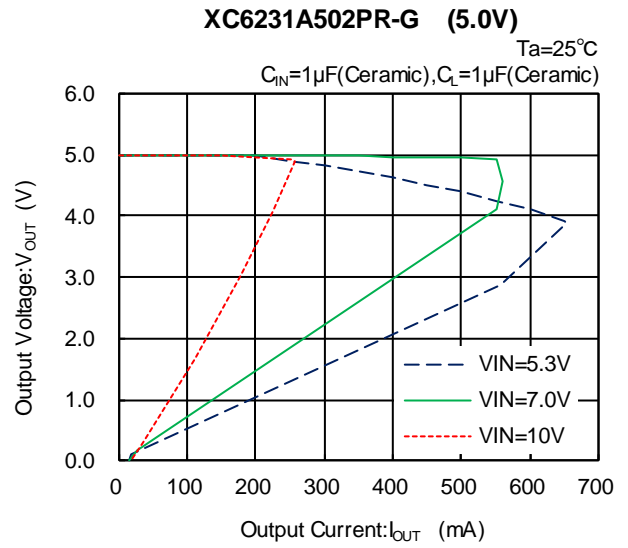
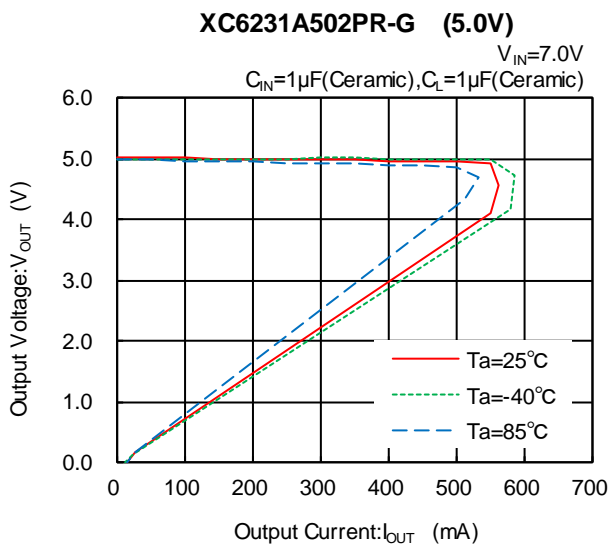

TYPICAL PERFORMANCE CHARACTERISTICS

(2) Output Voltage vs. Input Voltage

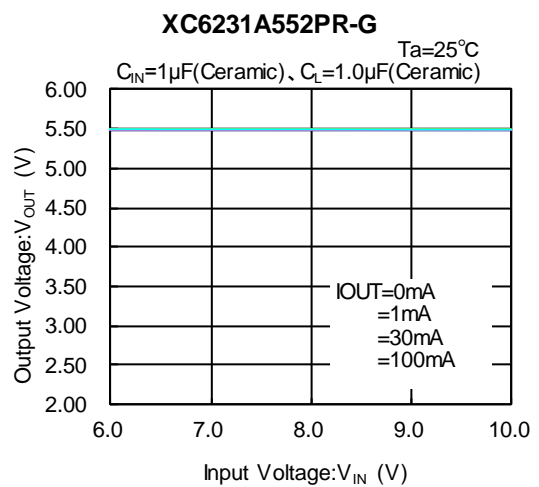
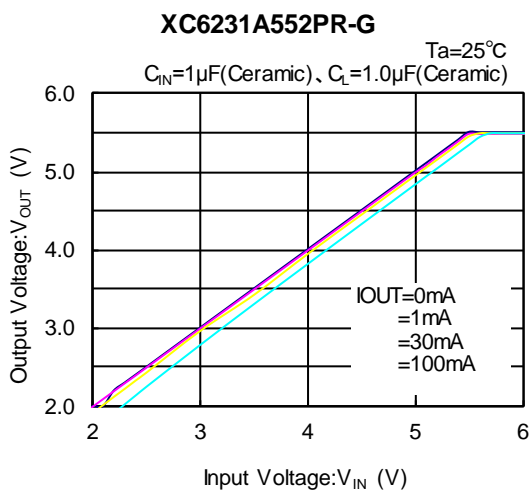
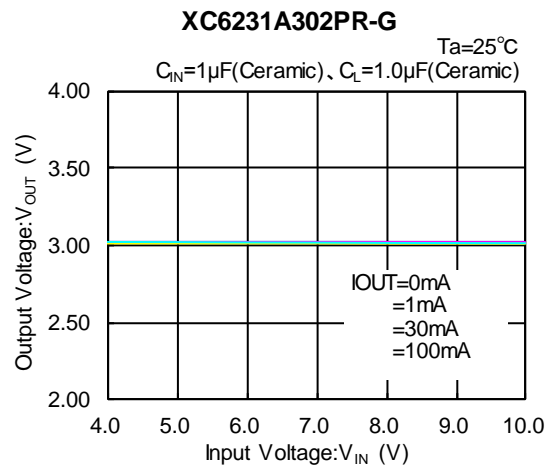
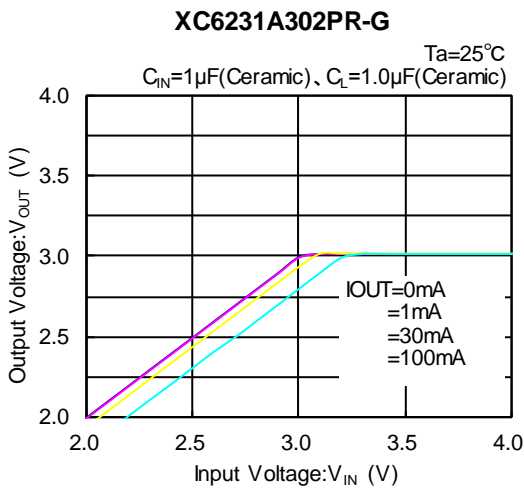
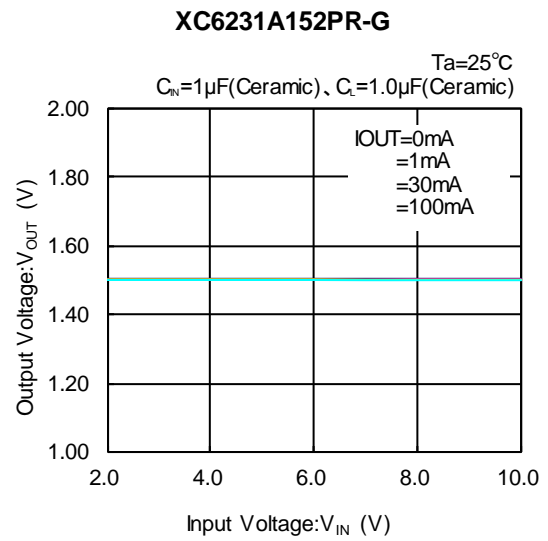
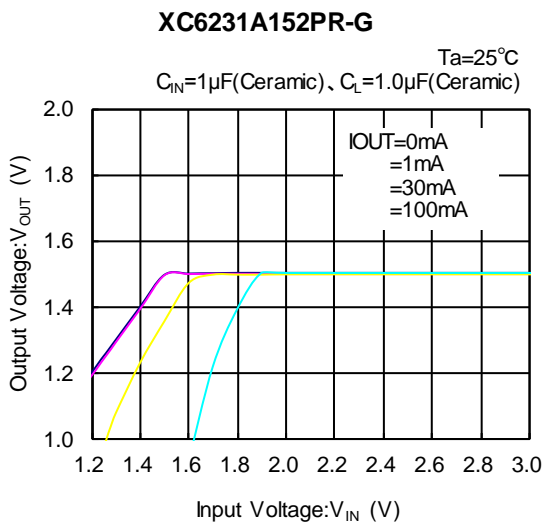

■ TYPICAL PERFORMANCE CHARACTERISTICS

(3) Dropout Voltage vs. Output Current

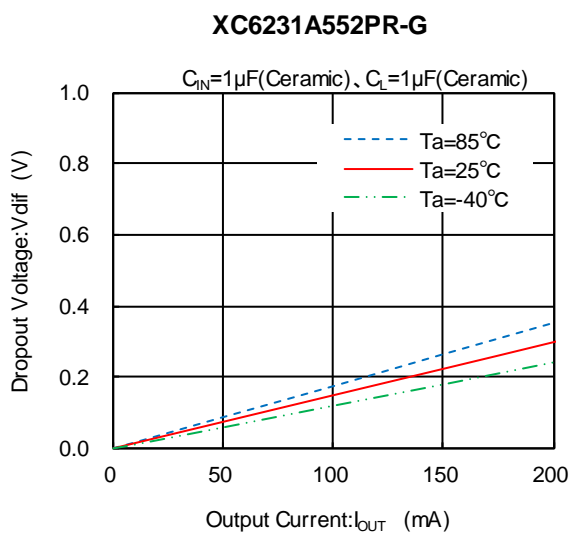
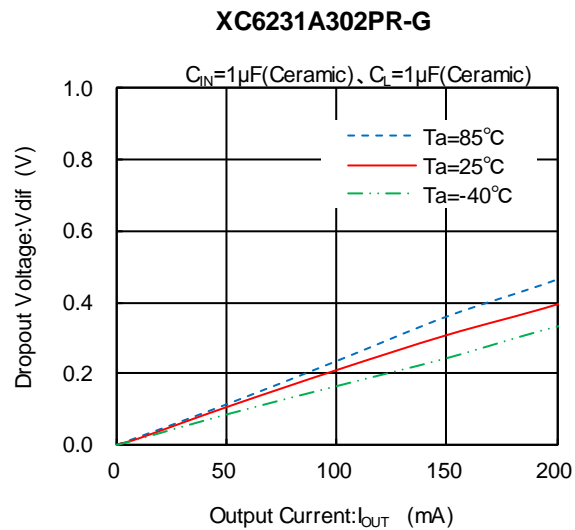
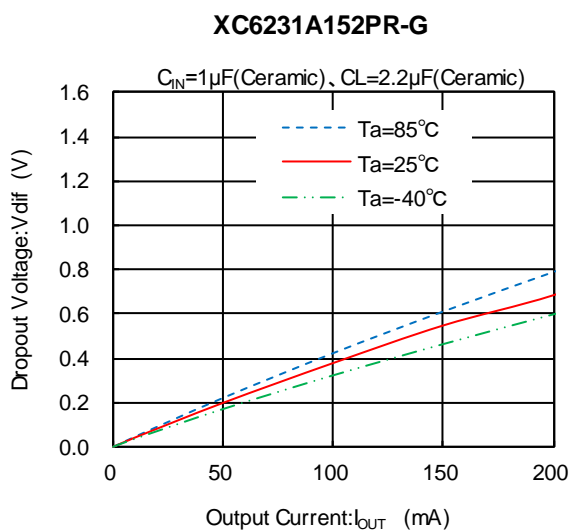

TYPICAL PERFORMANCE CHARACTERISTICS

(4) Supply Current vs. Input Voltage

XC6231A092PR-G

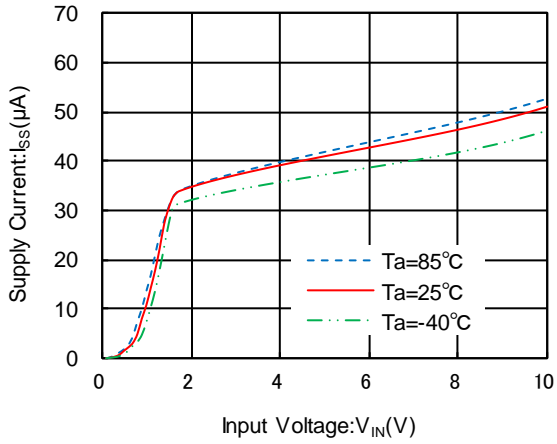

XC6231A182PR-G

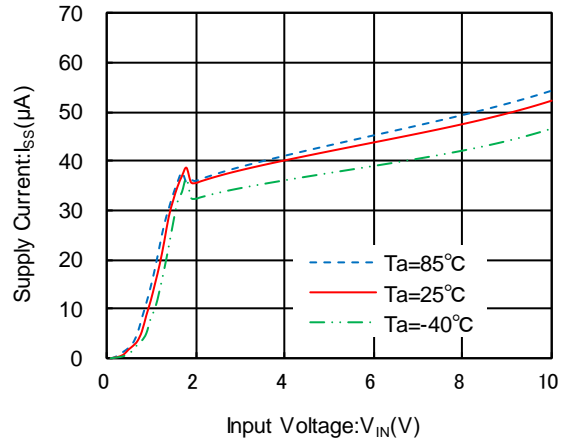

XC6231A252PR-G

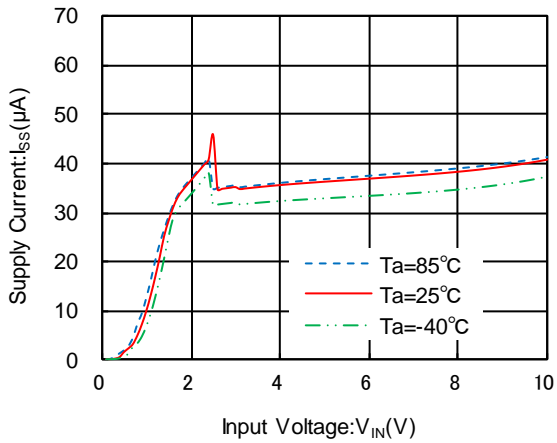

XC6231A302PR-G

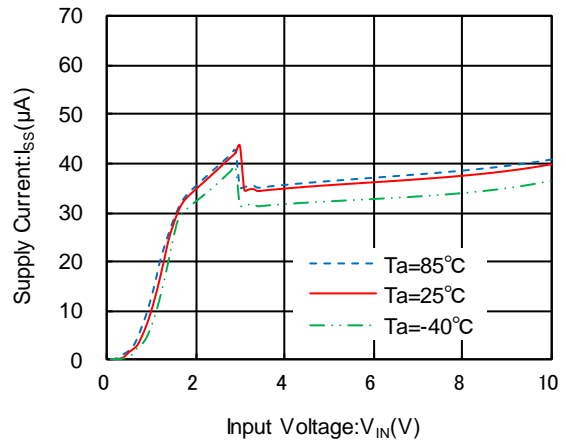

XC6231A502PR-G

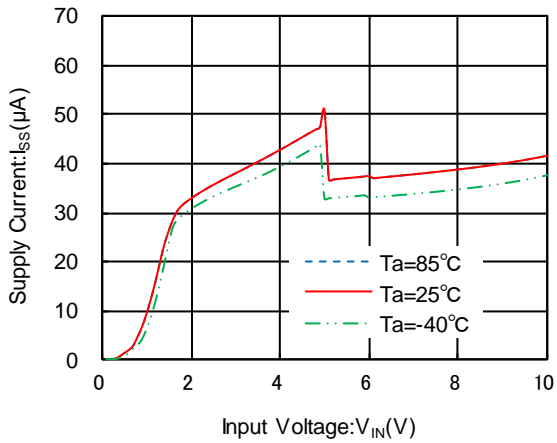

■ TYPICAL PERFORMANCE CHARACTERISTICS

(5) Rising Response Time

XC6231A152PR-G

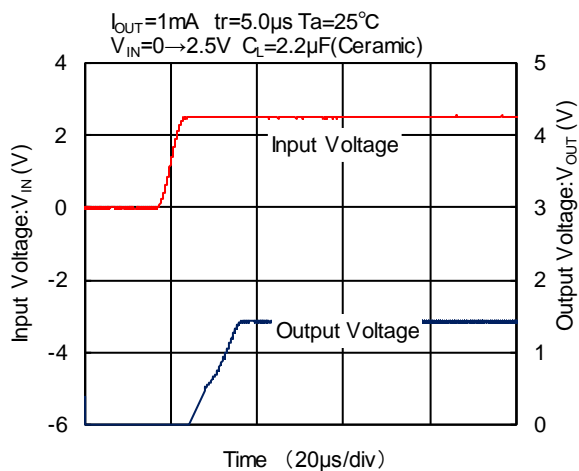

XC6231A152PR-G

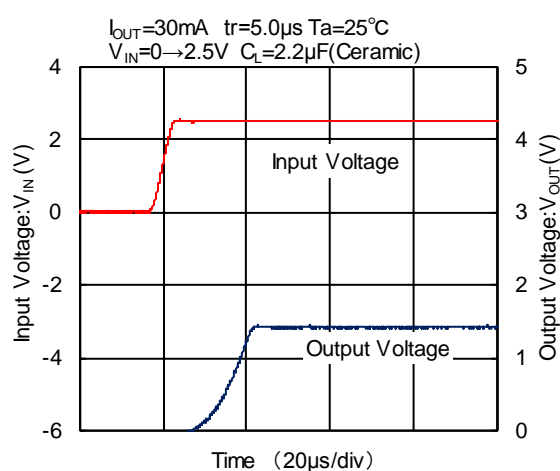

XC6231A152PR-G

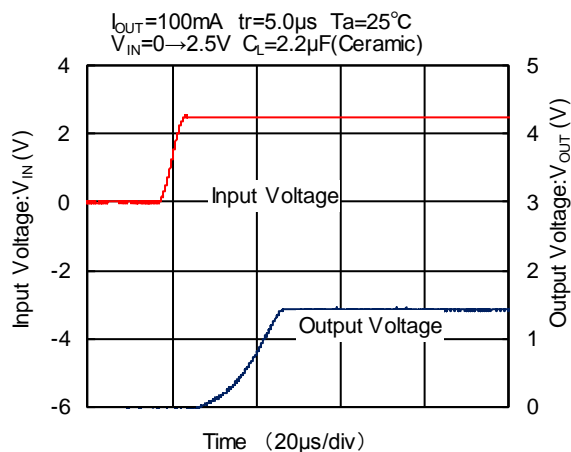

XC6231A302PR-G

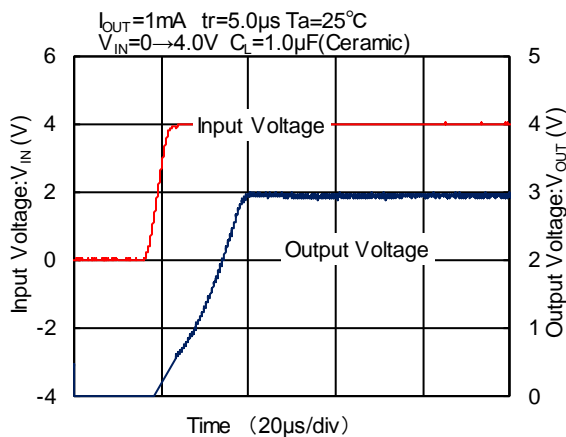

XC6231A302PR-G

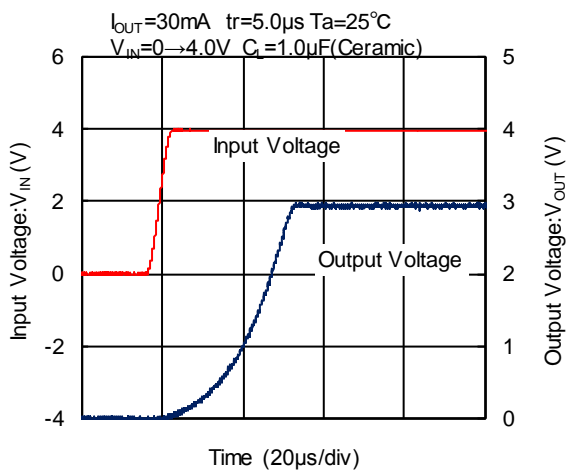

XC6231A302PR-G

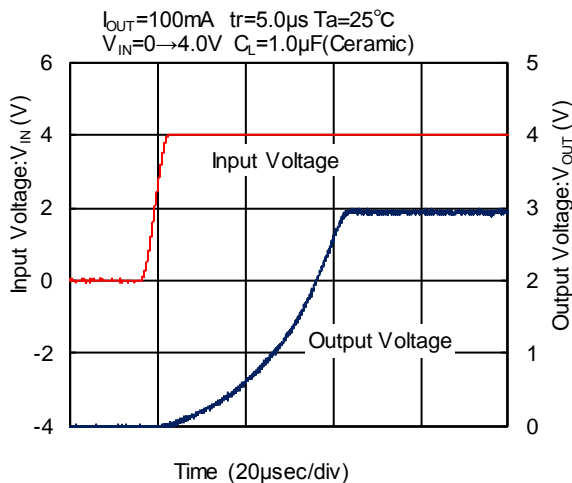

TYPICAL PERFORMANCE CHARACTERISTICS

(5) Rising Response Time(Continued)

XC6231A552PR-G

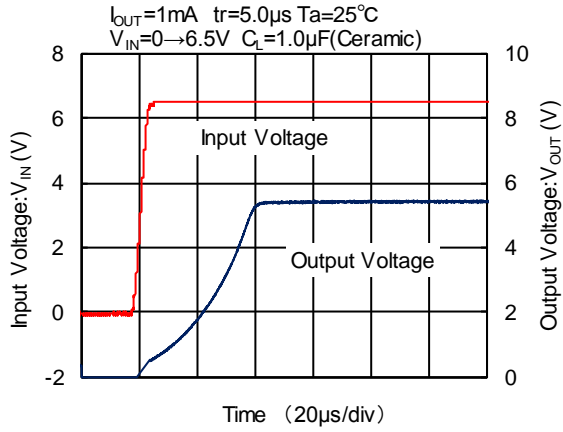

XC6231A552PR-G

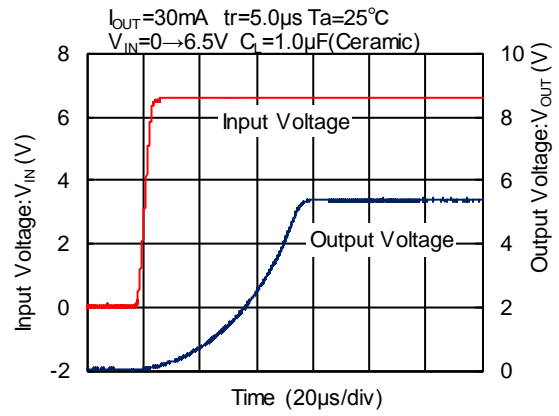

XC6231A552PR-G

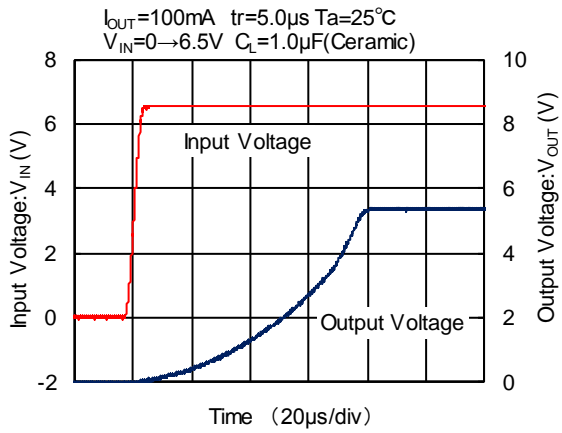

TYPICALPERFOTMANCE CHARACTERISTICS

(6)Input Transient Response

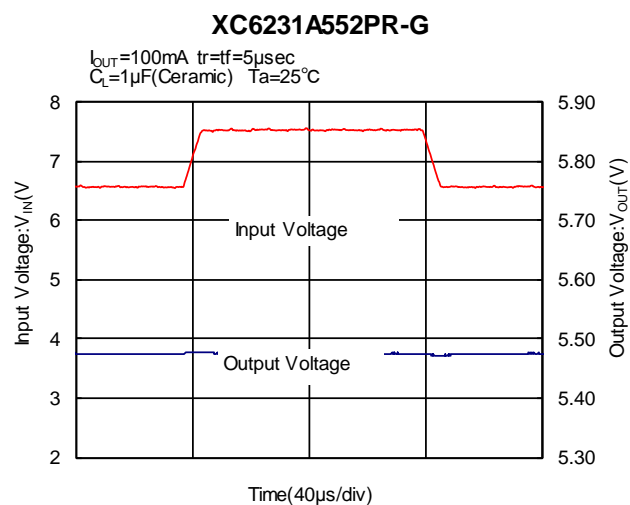
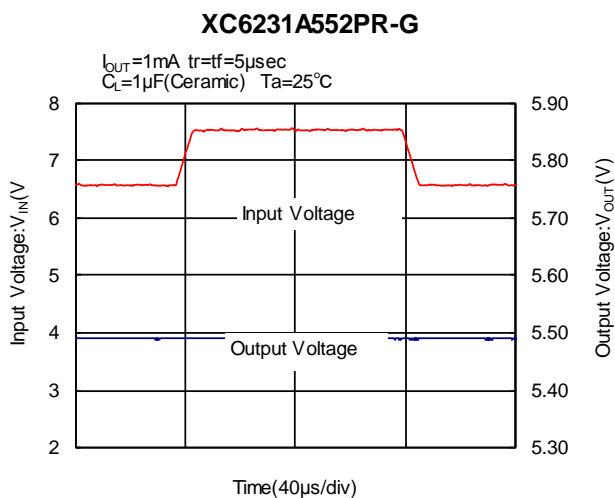
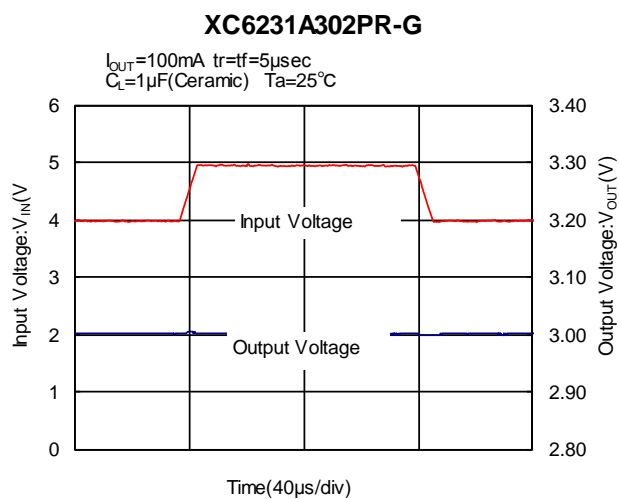
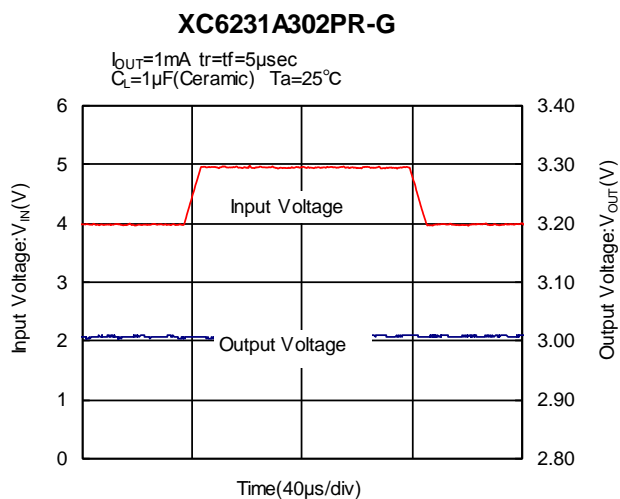
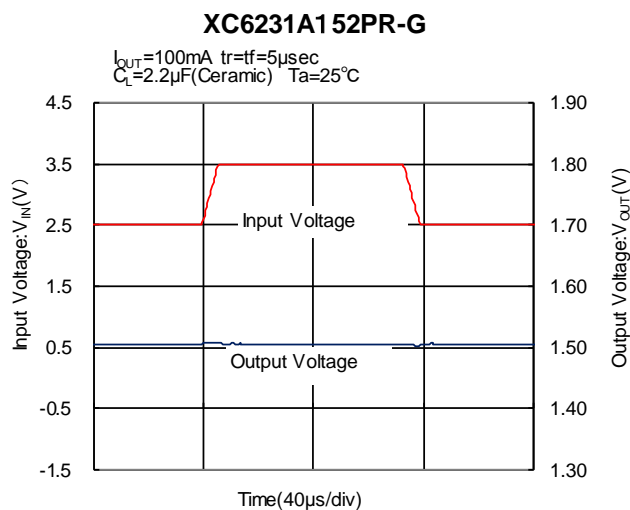
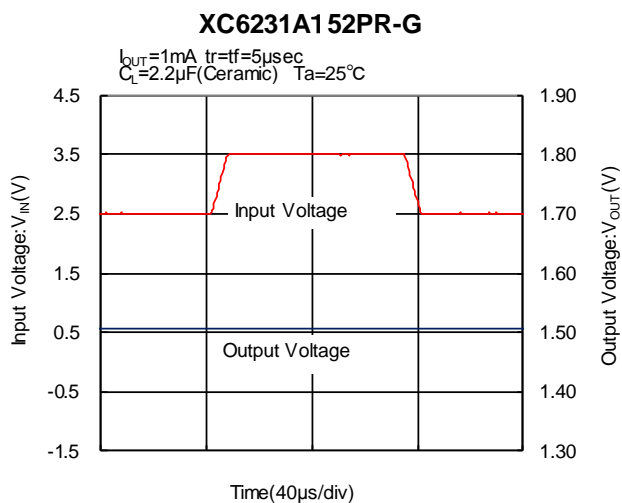

TYPICAL PERFORMANCE CHARACTERISTICS

(7) Load Transient Response

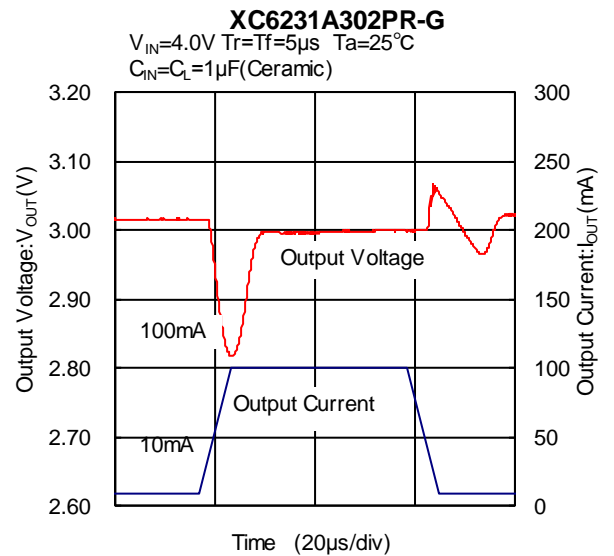
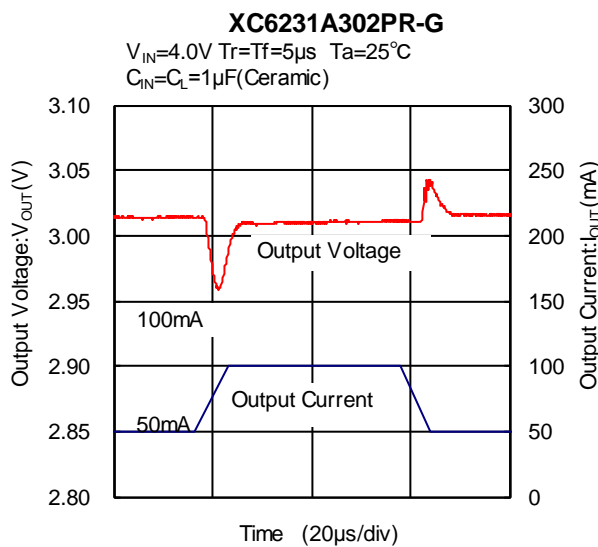
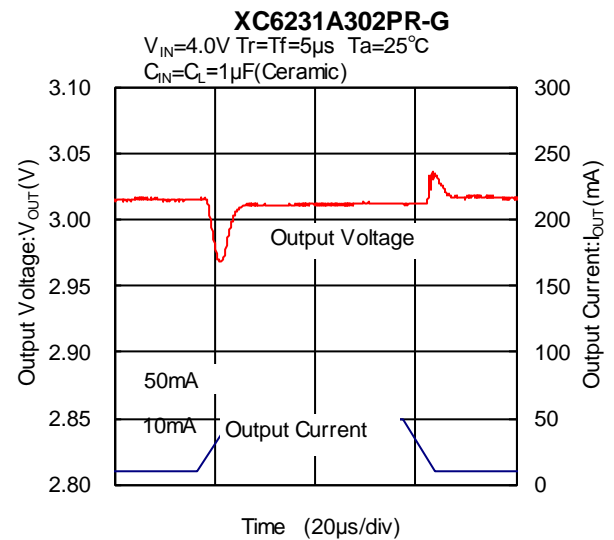
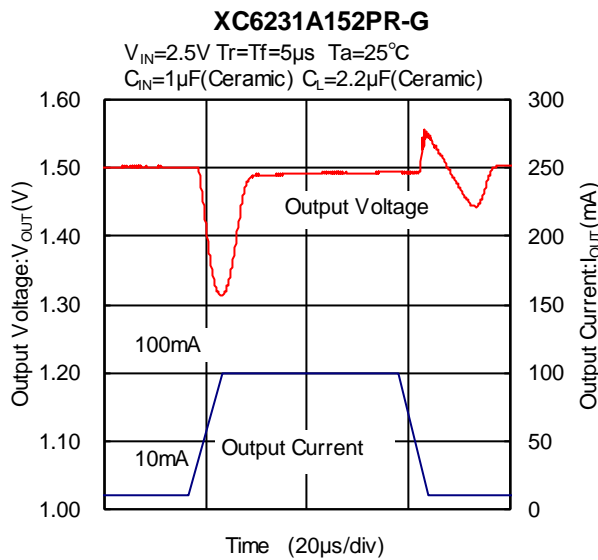
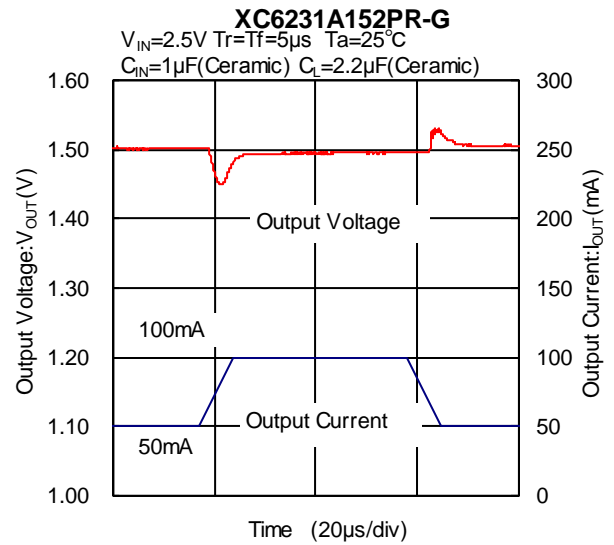
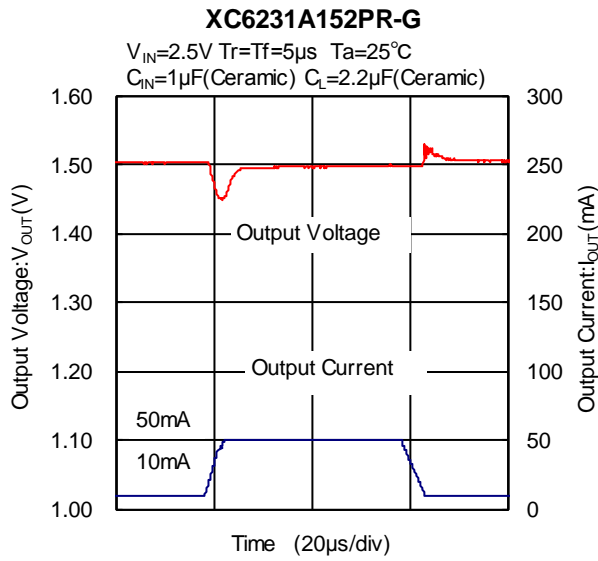

■ TYPICAL PERFORMANCE CHARACTERISTICS

(7) Load Transient Response (Continued)

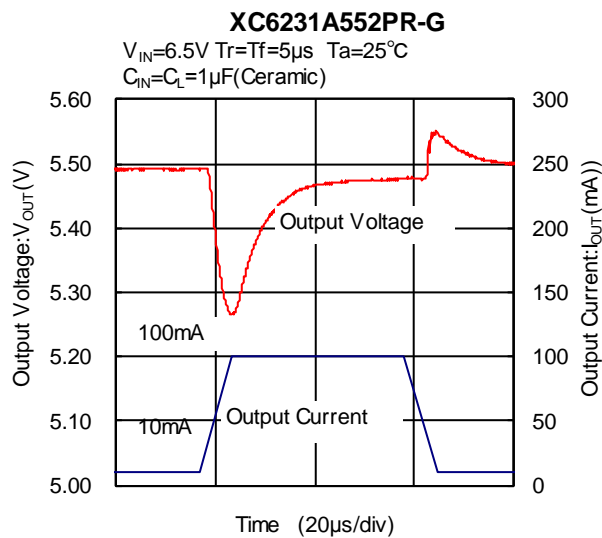
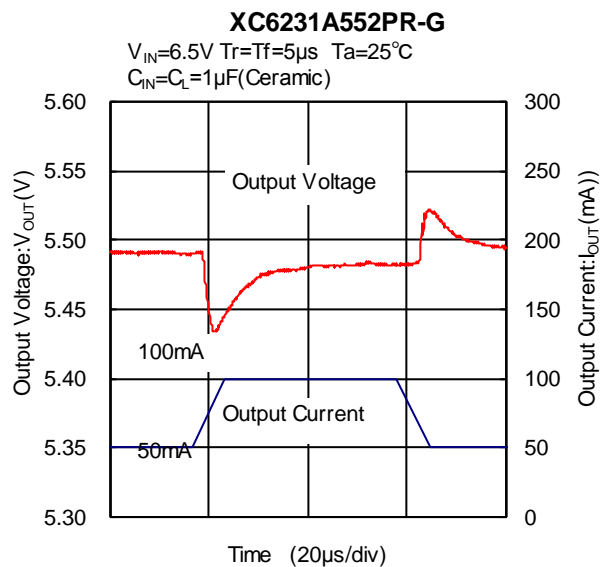
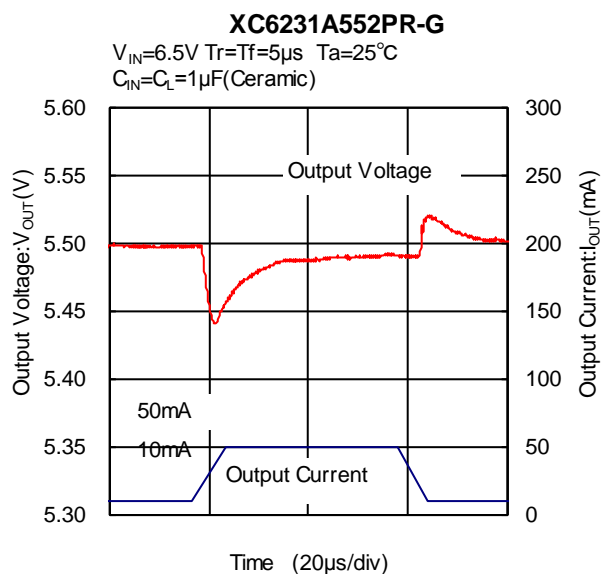

TYPICAL PERFORMANCE CHARACTERISTICS

(8) Power Supply Rejection Ratio

XC6231A302PR-G

$V_{IN}=4.0V_{DC}+1.0V_{p-pAC}$, $I_{OUT}=50mA$, $C_L=1.0\mu F$ (Ceramic), $T_a=25^\circ C$

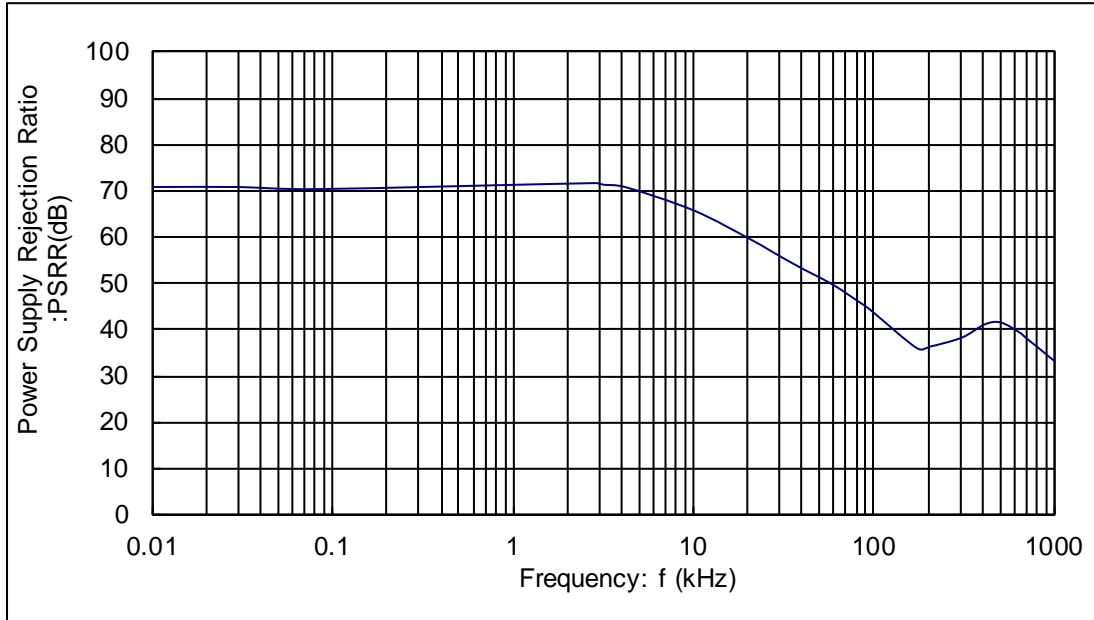

XC6231A502PR-G

$V_{IN}=6.0V_{DC}+1.0V_{p-pAC}$, $I_{OUT}=50mA$, $C_L=1.0\mu F$ (Ceramic), $T_a=25^\circ C$

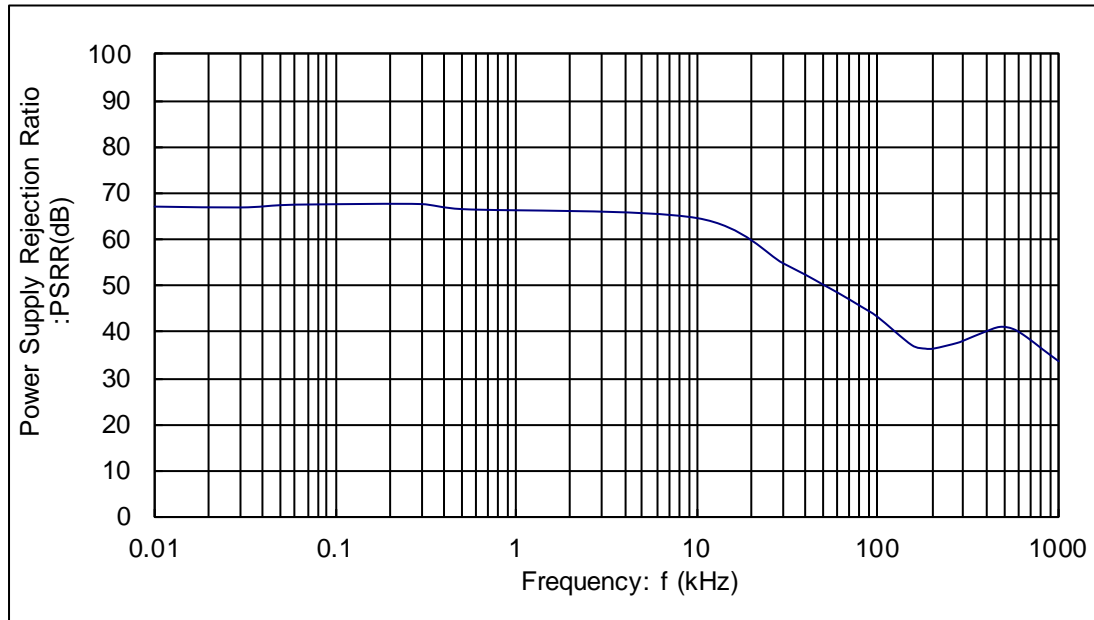

■ TYPICAL PERFORMANCE CHARACTERISTICS

(9) Output Noise Density

XC6231A302PR-G

$V_{IN}=4.0V$, $I_{OUT}=30mA$, $C_{IN}=C_L=1.0\mu F$ (Ceramic), $T_a=25^\circ C$

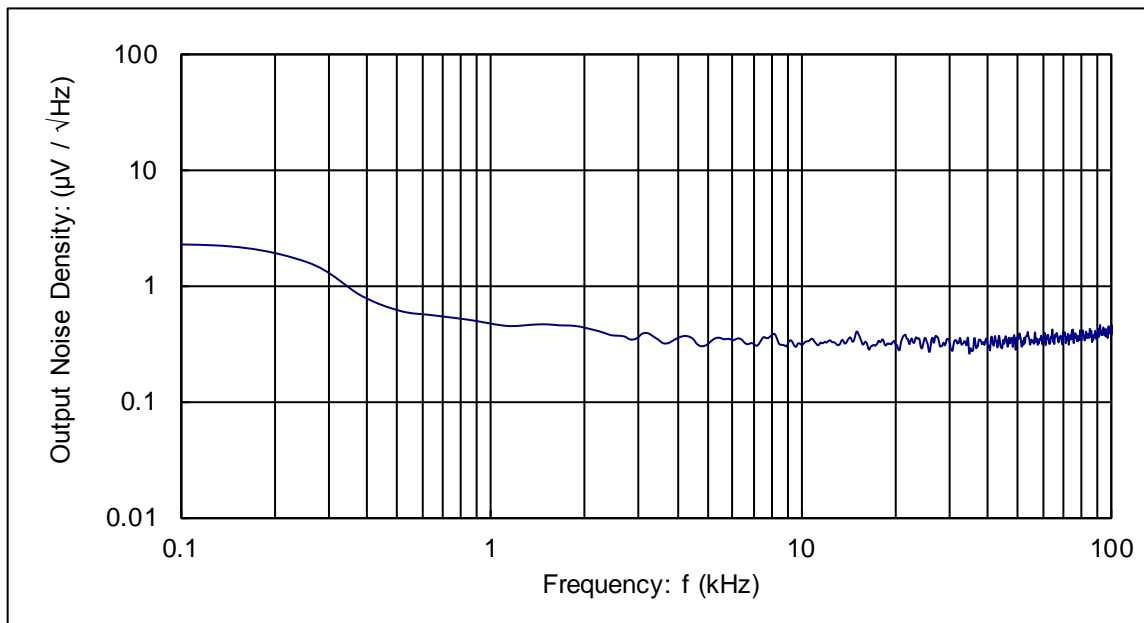

XC6231A502PR-G

$V_{IN}=6.0V$, $I_{OUT}=30mA$, $C_{IN}=C_L=1.0\mu F$ (Ceramic), $T_a=25^\circ C$

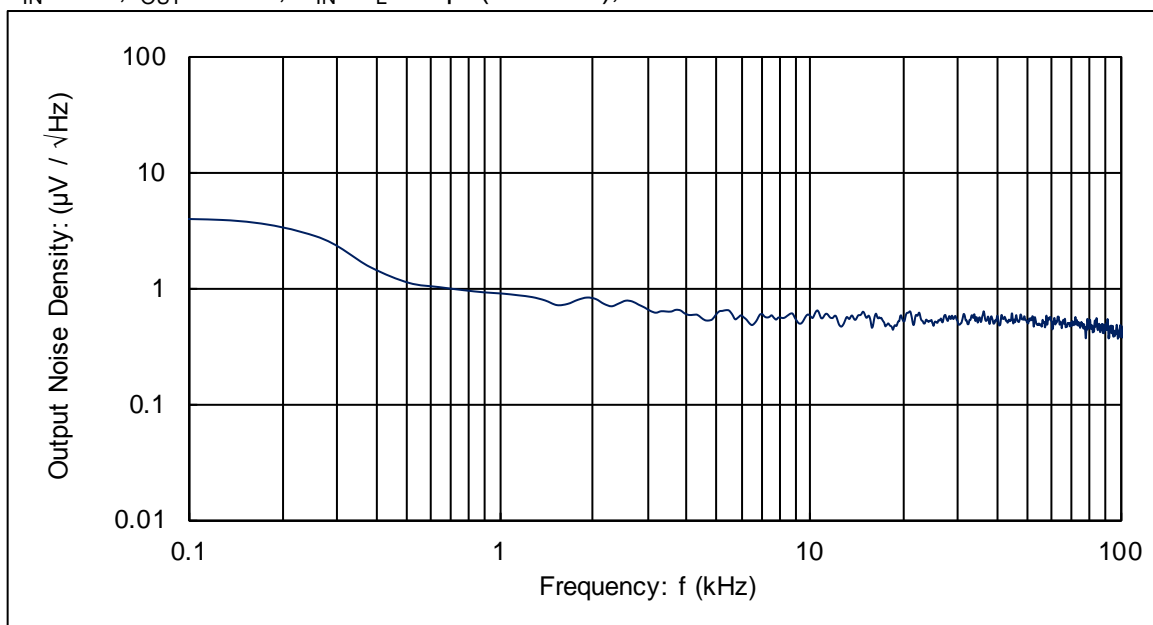

■ PACKAGING INFORMATION

For the latest package information go to, www.torexsemi.com/technical-support/packages

PACKAGE	OUTLIN / LAND PATTERN	THERMAL CHARACTERISTICS	
SOT-89-5	SOT-89-5 PKG	Standard Board	SOT-89-5 Power Dissipation
		JESD51-7 Board	

MARKING RULE

● SOT-89-5

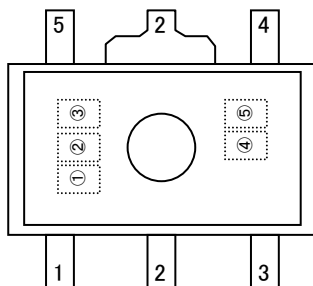

① represents product series

MARK	PRODUCT SERIES
1	XC6231A****-G

② represents regulator type and output voltage range

MARK	OUTPUT VOLTAGE (V)	PRODUCT SERIES
H	0.9~3.8	XC6231A****-G
K	3.9~5.5	

③ represents output voltage

MARK	OUTPUT VOLTAGE (V)		MARK	OUTPUT VOLTAGE (V)	
0	0.9	3.9	F	2.4	5.4
1	1.0	4.0	H	2.5	5.5
2	1.1	4.1	K	2.6	-
3	1.2	4.2	L	2.7	-
4	1.3	4.3	M	2.8	-
5	1.4	4.4	N	2.9	-
6	1.5	4.5	P	3.0	-
7	1.6	4.6	R	3.1	-
8	1.7	4.7	S	3.2	-
8	1.8	4.8	T	3.3	-
A	1.9	4.9	U	3.4	-
B	2.0	5.0	V	3.5	-
C	2.1	5.1	X	3.6	-
D	2.2	5.2	Y	3.7	-
E	2.3	5.3	Z	3.8	-

④⑤ represents production lot number

01~09, 0A~0Z, 11~9Z, A1~A9, AA~AZ, B1~ZZ in order.

(G, I, J, O, Q, W excluded)

1. The product and product specifications contained herein are subject to change without notice to improve performance characteristics. Consult us, or our representatives before use, to confirm that the information in this datasheet is up to date.
2. The information in this datasheet is intended to illustrate the operation and characteristics of our products. We neither make warranties or representations with respect to the accuracy or completeness of the information contained in this datasheet nor grant any license to any intellectual property rights of ours or any third party concerning with the information in this datasheet.
3. Applicable export control laws and regulations should be complied and the procedures required by such laws and regulations should also be followed, when the product or any information contained in this datasheet is exported.
4. The product is neither intended nor warranted for use in equipment of systems which require extremely high levels of quality and/or reliability and/or a malfunction or failure which may cause loss of human life, bodily injury, serious property damage including but not limited to devices or equipment used in 1) nuclear facilities, 2) aerospace industry, 3) medical facilities, 4) automobile industry and other transportation industry and 5) safety devices and safety equipment to control combustions and explosions. Do not use the product for the above use unless agreed by us in writing in advance.
5. Although we make continuous efforts to improve the quality and reliability of our products; nevertheless Semiconductors are likely to fail with a certain probability. So in order to prevent personal injury and/or property damage resulting from such failure, customers are required to incorporate adequate safety measures in their designs, such as system fail safes, redundancy and fire prevention features.
6. Our products are not designed to be Radiation-resistant.
7. Please use the product listed in this datasheet within the specified ranges.
8. We assume no responsibility for damage or loss due to abnormal use.
9. All rights reserved. No part of this datasheet may be copied or reproduced unless agreed by Torex Semiconductor Ltd in writing in advance.

TOREX SEMICONDUCTOR LTD.

X-ON Electronics

Largest Supplier of Electrical and Electronic Components

Click to view similar products for [LDO Voltage Regulators](#) category:

Click to view products by [Torex Semiconductor](#) manufacturer:

Other Similar products are found below :

[L79M05TL-E](#) [PT7M8202B12TA5EX](#) [TCR3DF185,LM\(CT](#) [TCR3DF24,LM\(CT](#) [TCR3DF285,LM\(CT](#) [TCR3DF31,LM\(CT](#)
[TCR3DF45,LM\(CT](#) [MP2013GQ-33-Z](#) [059985X](#) [NCP4687DH15T1G](#) [701326R](#) [TCR2EN28,LF\(S](#) [NCV8170AXV250T2G](#)
[TCR3DF27,LM\(CT](#) [TCR3DF19,LM\(CT](#) [TCR3DF125,LM\(CT](#) [TCR2EN18,LF\(S](#) [AP2112R5A-3.3TRG1](#) [AP7315-25W5-7](#)
[IFX30081LDVGRNXUMA1](#) [AP2113KTR-G1](#) [AP2111H-1.2TRG1](#) [ZLDO1117QK50TC](#) [AZ1117ID-ADJTRG1](#) [TCR3DG12,LF](#) [MIC5514-](#)
[3.3YMT-T5](#) [MIC5512-1.2YMT-T5](#) [MIC5317-2.8YM5-T5](#) [SCD7912BTG](#) [NCP154MX180270TAG](#) [SCD33269T-5.0G](#)
[NCV8170BMX330TCG](#) [NCV8170AMX120TCG](#) [NCP706ABMX300TAG](#) [NCP153MX330180TCG](#) [NCP114BMX075TCG](#) [MC33269T-3.5G](#)
[CAT6243-ADJCMT5T](#) [TCR3DG33,LF](#) [AP2127N-1.0TRG1](#) [TCR4DG35,LF](#) [LT1117CST-3.3](#) [TAR5S15U\(TE85L,F\)](#) [TAR5S18U\(TE85L,F\)](#)
[TCR3UG19A,LF](#) [TCR4DG105,LF](#) [NCV8170AMX360TCG](#) [MIC94310-NYMT-T5](#) [NCV4266-2CST33T3G](#) [NCV8186BMN175TAG](#)