

10V Input, 200mA Low Consumption Current Regulator

■ GENERAL DESCRIPTION

The XC62FJ series is a highly precise, low power consumption, positive voltage regulator manufactured with CMOS and laser trimming technologies.

The series provides large currents with a significantly small dropout voltage.

The XC62FJ consists of a current limiter circuit, a driver transistor, a precision reference voltage and an error amplifier.

The output voltage is selectable in 0.1V steps between 1.7V ~ 6.0V.

■ APPLICATIONS

- Smart meter
- Walky-talky
- Blood pressure manometer
- Applications with 2Li-ion batteries

■ FEATURES

Maximum Output Current	: 200mA
Dropout Voltage	: 160mV@I _{OUT} =100mA (V _{OUT} =5.0V)
Operating Voltage Range	: 1.8V ~ 10V
Output Voltage Range	: 1.7V ~ 6.0V (±2.0%) 0.1V increments
Consumption Current	: 2.0µA (TYP.)
External Capacitor	: Ceramic Capacitor
Operating Ambient Temperature	: -40°C ~ 85°C
Package	: SOT-89
Environmentally Friendly	: EU RoHS Compliant, Pb Free

■ TYPICAL APPLICATION CIRCUIT

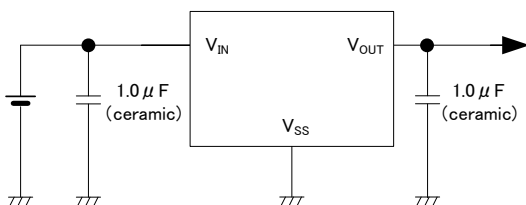

■ TYPICAL PERFORMANCE CHARACTERISTICS

- Consumption Current vs. Input Voltage

XC62FJ3302PR-G

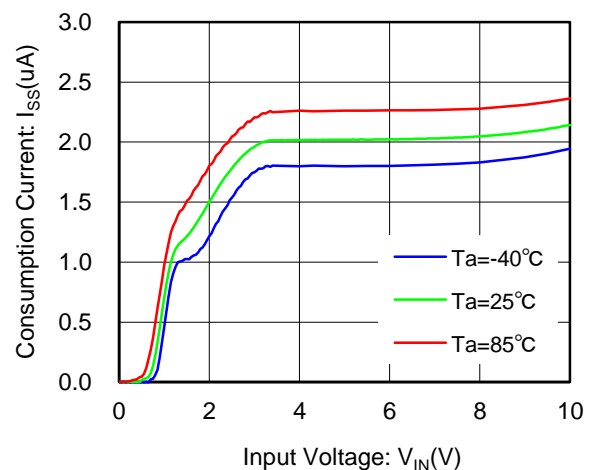

■ BLOCK DIAGRAM

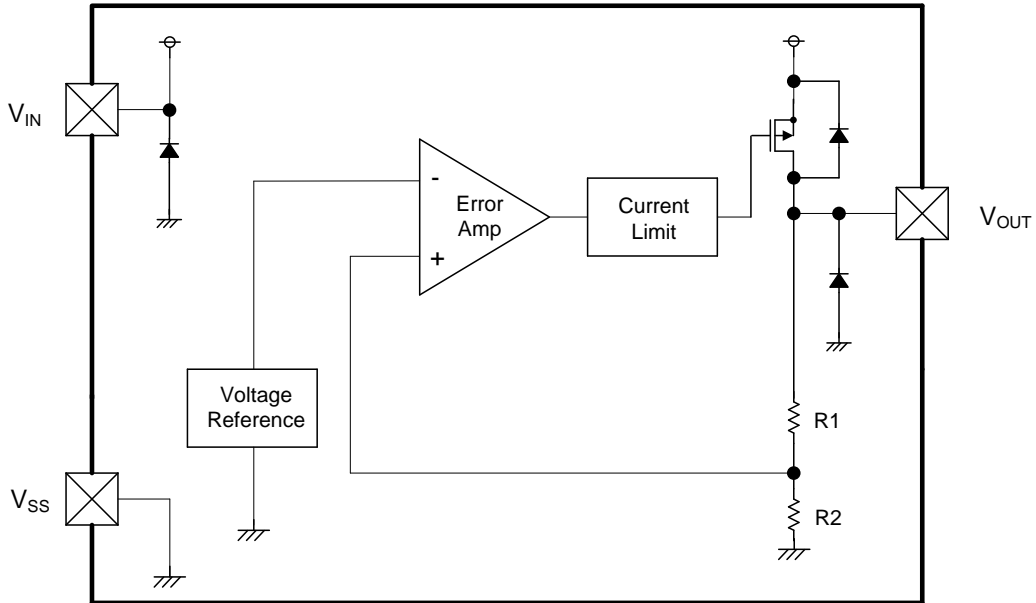

* Diodes inside the circuits are ESD protection diodes and parasitic diodes.

■ PIN CONFIGURATION

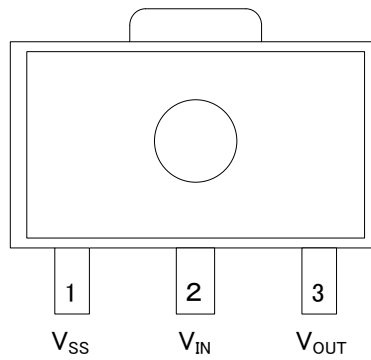

SOT-89
(TOP VIEW)

■ PIN ASSIGNMENT

PIN NUMBER	PIN NAME	FUNCTION
SOT-89		
1	V _{SS}	Ground
2	V _{IN}	Power Supply Input
3	V _{OUT}	Output

■ PRODUCT CLASSIFICATION

● Ordering Information

XC62FJ①②③④⑤⑥-⑦

DESIGNATOR	DESCRIPTION	SYMBOL	DESCRIPTION
①②	Output Voltage	17 ~ 60	e.g. 30: 3.0V, 50: 5.0V
③④	Output Voltage Accuracy	02	±2.0%
⑤⑥-⑦ ^(*)	Package (Order Unit)	PR-G	SOT-89 (1,000 pcs/Reel)

^(*) The “-G” suffix denotes Halogen and Antimony free as well as being fully EU RoHS compliant.

■ ABSOLUTE MAXIMUM RATINGS

Ta=25°C

PARAMETER		SYMBOL	RATINGS	UNITS
Input Voltage		V _{IN}	-0.3 ~ 12.0	V
Output Current		I _{OUT}	500 ^(*)	mA
Output Voltage		V _{OUT}	-0.3 ~ V _{IN} + 0.3 or 12.0 ^(**)	V
Power Dissipation ^(***)	SOT-89	Pd	1000 (40mm x 40mm Standard Board) ^(***)	mW
Operating Ambient Temperature		Topr	-40 ~ 85	°C
Storage Temperature		Tstg	-55 ~ 125	°C

All voltages are described based on V_{SS}.

^(*) I_{OUT} ≤ Pd / (V_{IN} - V_{OUT})

^(**) The maximum value should be either V_{IN}+0.3V or 12.0V in the lowest

^(***) The allowable loss figure shown is PCB mounted and is for reference only.

Please refer to PACKAGING INFORMATION for the mounting condition.

ELECTRICAL CHARACTERISTICS

Ta=25°C

PARAMETER	SYMBOL	CONDITIONS	MIN	TYP	MAX	UNIT	CIRCUIT
Output Voltage	$V_{OUT(E)}$ ⁽²⁾	$V_{IN}=V_{OUT(T)}+1.0V$, $I_{OUT}=\{C1\}^{(6)}$ mA	E-1 ⁽⁵⁾	$V_{OUT(T)}$	E-1 ⁽⁵⁾	V	②
Maximum Output Current	I_{OUTMAX}	$V_{IN}=V_{OUT(T)}+1.0V$ $V_{OUT(E)} \geq V_{OUT(T)} \times 0.9$	E-2 ⁽⁵⁾	-	-	mA	②
Load Regulation	ΔV_{OUT}	$V_{IN}=V_{OUT(T)}+1.0V$ $1mA \leq I_{OUT} \leq \{C2\}^{(6)}$ mA	-	E-3 ⁽⁵⁾		mV	②
Dropout Voltage1	V_{dif1} ⁽³⁾	$I_{OUT}=\{C3\}^{(6)}$ mA	-	E-4 ⁽⁵⁾		mV	②
Dropout Voltage2	V_{dif2} ⁽³⁾	$I_{OUT}=\{C4\}^{(6)}$ mA	-	E-5 ⁽⁵⁾		mV	②
Consumption current	I_{SS}	$V_{IN}=V_{OUT(T)}+1.0V$	-	2.0	E-6 ⁽⁵⁾	μA	①
Line Regulation	$\frac{\Delta V_{OUT}}{(\Delta V_{IN} \cdot V_{OUT})}$	$V_{OUT(T)}+1.0V \leq V_{IN} \leq 10.0V$ $I_{OUT}=\{C5\}^{(6)}$ mA	-	0.2	0.3	%/V	②
Input Voltage ⁽⁶⁾	V_{IN}	-	1.8	-	10	V	-
Output Voltage Temperature Characteristics	$\frac{\Delta V_{OUT}}{(\Delta T_{opr} \cdot V_{OUT})}$	$I_{OUT}=\{C1\}^{(6)}$ mA $-40^{\circ}C \leq T_{opr} \leq 85^{\circ}C$	-	±100	-	ppm/°C	②

⁽¹⁾ $V_{OUT(T)}$ is Nominal output voltage

⁽²⁾ $V_{OUT(E)}$ is Effective output voltage

(i.e. the output voltage when " $(V_{OUT(T)} + 1.0V)$ " is provided at the V_{IN} pin while maintaining a certain I_{OUT} value.)

⁽³⁾ $V_{dif}=\{V_{IN1}-V_{OUT1}\}$

V_{IN1} is the input voltage when V_{OUT1} appears at the V_{OUT} pin while input voltage is gradually decreased.

V_{OUT1} is the voltage equal to 98% of the normal output voltage when amply stabilized $V_{OUT(T)} + 1.0V$ is input at the V_{IN} pin.

⁽⁴⁾ Over 1.8V input voltage (Minimum operation voltage) is required when the V_{OUT} is lower than 1.8V.

⁽⁵⁾ Refer to the VOLTAGE CHART

⁽⁶⁾ Refer to the VOLTAGE CONDITIONS CHART

■ ELECTRICAL CHARACTERISTICS

VOLTAGE CHART

SYMBOL	E-1		E-2	E-3		E-4		E-5		E-6
NOMINAL OUTPUT VOLTAGE	OUTPUT VOLTAGE (V)		MAXIMUM OUTPUT CURRENT (mA)	LOAD REGULATION (mV)		DROPOUT VOLTAGE1 (mV)		DROPOUT VOLTAGE2 (mV)		CONSUMPTION CURRENT (μ A)
$V_{OUT(T)}$	$V_{OUT(E)}$		I_{OUTMAX}	ΔV_{OUT}		V_{dif1}		V_{dif2}		I_{SS}
	MIN.	MAX.		MIN.	TYP.	MAX.	TYP.	MAX.	TYP.	
1.7	1.666	1.734	80	10	30	200	370	450	710	5.0
1.8	1.764	1.836	80	10	30	200	370	450	710	5.0
1.9	1.862	1.938	80	10	30	200	370	450	710	5.0
2.0	1.960	2.040	100	15	40	200	370	450	710	5.0
2.1	2.058	2.142	100	15	40	200	370	450	710	5.0
2.2	2.156	2.244	100	15	40	200	370	450	710	5.0
2.3	2.254	2.346	100	15	40	200	370	450	710	5.0
2.4	2.352	2.448	100	15	40	200	370	450	710	5.0
2.5	2.450	2.550	100	15	40	200	370	450	710	5.0
2.6	2.548	2.652	100	15	40	200	370	450	710	5.0
2.7	2.646	2.754	100	15	40	200	370	450	710	5.0
2.8	2.744	2.856	100	15	40	200	370	450	710	5.0
2.9	2.842	2.958	100	15	40	200	370	450	710	5.0
3.0	2.940	3.060	150	20	50	200	360	450	700	5.0
3.1	3.038	3.162	150	20	50	200	360	450	700	5.0
3.2	3.136	3.264	150	20	50	200	360	450	700	5.0
3.3	3.234	3.366	150	20	50	200	360	450	700	5.0
3.4	3.332	3.468	150	20	50	200	360	450	700	5.0
3.5	3.430	3.570	150	20	50	200	360	450	700	5.0
3.6	3.528	3.672	150	20	50	200	360	450	700	5.0
3.7	3.626	3.774	150	20	50	200	360	450	700	5.0
3.8	3.724	3.876	150	20	50	200	360	450	700	5.0
3.9	3.822	3.978	150	20	50	200	360	450	700	5.0
4.0	3.920	4.080	180	25	60	180	350	420	630	6.0
4.1	4.018	4.182	180	25	60	180	350	420	630	6.0
4.2	4.116	4.284	180	25	60	180	350	420	630	6.0
4.3	4.214	4.386	180	25	60	180	350	420	630	6.0
4.4	4.312	4.488	180	25	60	180	350	420	630	6.0
4.5	4.410	4.590	180	25	60	180	350	420	630	6.0
4.6	4.508	4.692	180	25	60	180	350	420	630	6.0
4.7	4.606	4.794	180	25	60	180	350	420	630	6.0
4.8	4.704	4.896	180	25	60	180	350	420	630	6.0
4.9	4.802	4.998	180	25	60	180	350	420	630	6.0
5.0	4.900	5.100	200	30	70	160	340	400	600	6.0
5.1	4.998	5.202	200	30	70	160	340	400	600	6.0
5.2	5.096	5.304	200	30	70	160	340	400	600	6.0
5.3	5.194	5.406	200	30	70	160	340	400	600	6.0
5.4	5.292	5.508	200	30	70	160	340	400	600	6.0
5.5	5.390	5.610	200	30	70	160	340	400	600	6.0
5.6	5.488	5.712	200	30	70	160	340	400	600	6.0
5.7	5.586	5.814	200	30	70	160	340	400	600	6.0
5.8	5.684	5.916	200	30	70	160	340	400	600	6.0
5.9	5.782	6.018	200	30	70	160	340	400	600	6.0
6.0	5.880	6.120	200	30	70	150	330	400	600	6.0

■ ELECTRICAL CHARACTERISTICS (Continued)

VOLTAGE CONDITIONS CHART

NOMINAL OUTPUT VOLTAGE	C1	C2	C3	C4	C5
	OUTPUT VOLTAGE	LOAD REGULATION	DROPOUT VOLTAGE1	DROPOUT VOLTAGE2	LINE REGULATION
$V_{OUT(T)}$	I_{OUT} (mA)	I_{OUT} (mA)	I_{OUT} (mA)	I_{OUT} (mA)	I_{OUT} (mA)
1.7	40	40	40	80	40
1.8	40	40	40	80	40
1.9	40	40	40	80	40
2.0	40	60	60	120	40
2.1	40	60	60	120	40
2.2	40	60	60	120	40
2.3	40	60	60	120	40
2.4	40	60	60	120	40
2.5	40	60	60	120	40
2.6	40	60	60	120	40
2.7	40	60	60	120	40
2.8	40	60	60	120	40
2.9	40	60	60	120	40
3.0	40	80	80	160	40
3.1	40	80	80	160	40
3.2	40	80	80	160	40
3.3	40	80	80	160	40
3.4	40	80	80	160	40
3.5	40	80	80	160	40
3.6	40	80	80	160	40
3.7	40	80	80	160	40
3.8	40	80	80	160	40
3.9	40	80	80	160	40
4.0	40	100	100	200	40
4.1	40	100	100	200	40
4.2	40	100	100	200	40
4.3	40	100	100	200	40
4.4	40	100	100	200	40
4.5	40	100	100	200	40
4.6	40	100	100	200	40
4.7	40	100	100	200	40
4.8	40	100	100	200	40
4.9	40	100	100	200	40
5.0	40	100	100	200	40
5.1	40	100	100	200	40
5.2	40	100	100	200	40
5.3	40	100	100	200	40
5.4	40	100	100	200	40
5.5	40	100	100	200	40
5.6	40	100	100	200	40
5.7	40	100	100	200	40
5.8	40	100	100	200	40
5.9	40	100	100	200	40
6.0	40	100	100	200	40

■ TEST CIRCUITS

CIRCUIT①

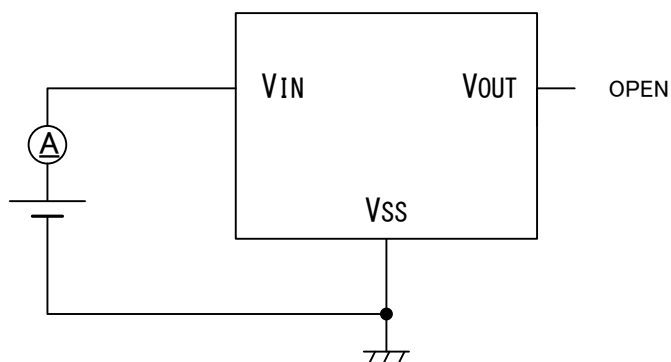

CIRCUIT②

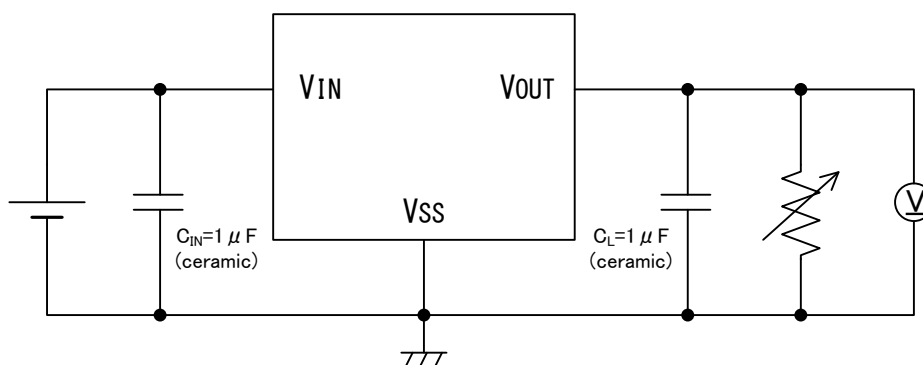

■ OPERATIONAL EXPLANATION

<External Capacitor>

The XC62FJ series needs an output capacitor C_L for phase compensation. In order to ensure the stable phase compensation, please place an output capacitor of $1.0\ \mu\text{F}$ or bigger at the V_{OUT} pin and V_{SS} pin as close as possible. For a stable power input, please connect an input capacitor (C_{IN}) of $1.0\ \mu\text{F}$ between the input pin (V_{IN}) and the ground pin (V_{SS}).

■ NOTES ON USE

1. For temporary, transitional voltage drop or voltage rising phenomenon, the IC is liable to malfunction should the ratings be exceeded.
2. Where wiring impedance is high, operations may become unstable due to noise and/or phase lag depending on output current.
3. An oscillation may occur by the impedance between a power supply and the input of the IC. Where the impedance is 10Ω or more, please use an input capacitor (C_{IN}) of at least $1\mu\text{F}$. In case of high output current, operation can be stabilized by increasing the input capacitor value. Also an oscillation may occur if the input capacitor value is smaller than the input impedance when the output capacitance (C_L) is large. In such cases, operations can be stabilized by either increasing the input capacitor value or reducing the output capacitor value.
4. Torex places an importance on improving our products and their reliability.
We request that users incorporate fail-safe designs and post-aging prevention treatment when using Torex products in their systems.

TYPICAL PERFORMANCE CHARACTERISTICS

(1) Output Voltage vs. Output Current

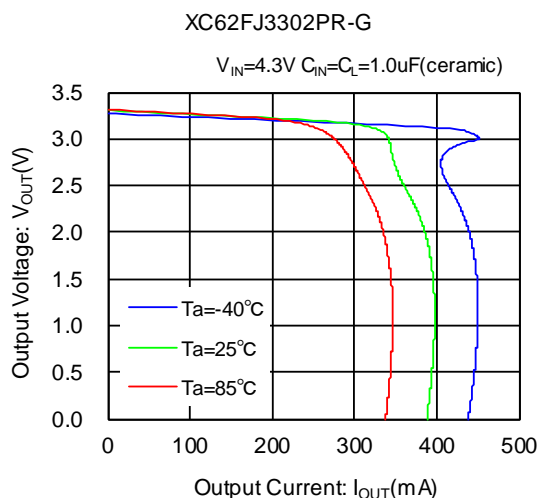

(2) Output Voltage vs. Input Voltage

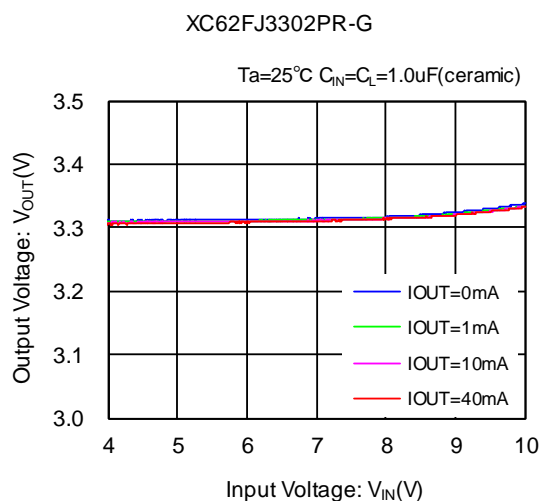
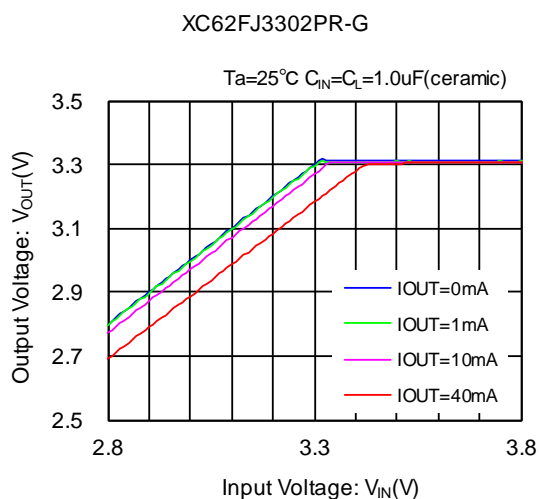

(3) Dropout Voltage vs. Output Current

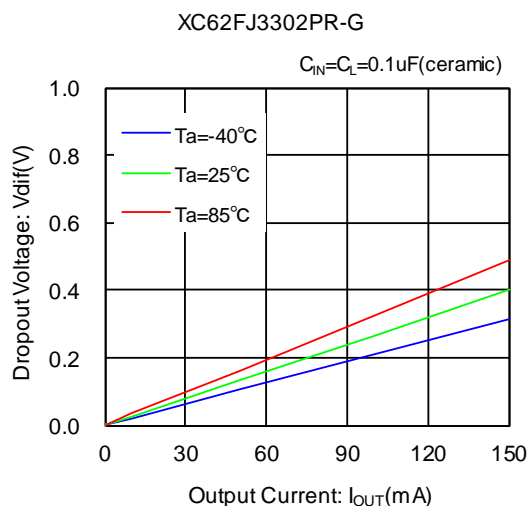

(4) Consumption Current vs. Input Voltage

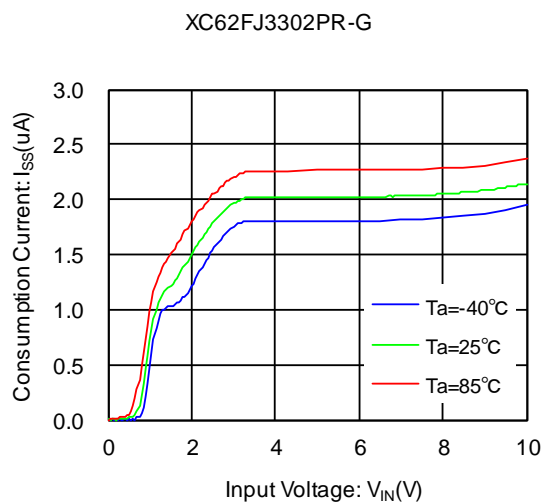

TYPICAL PERFORMANCE CHARACTERISTICS (Continued)

(5) Output Voltage vs. Ambient Temperature

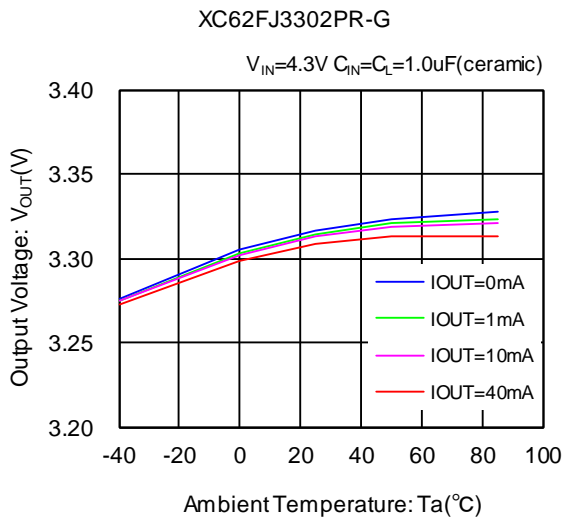

(6) Consumption Current vs. Ambient Temperature

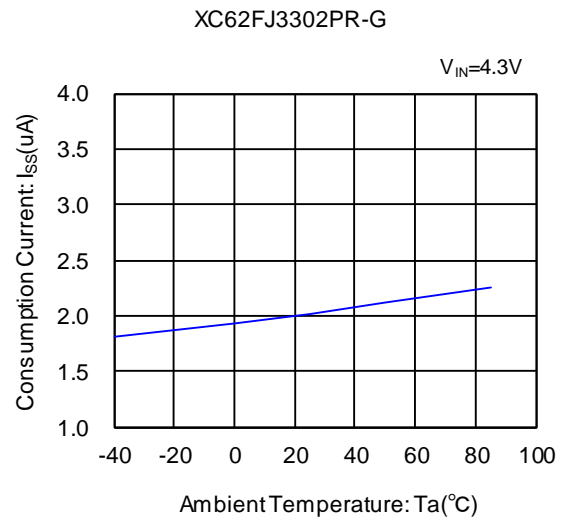

■ TYPICAL PERFORMANCE CHARACTERISTICS (Continued)

(7) Input Transient Response

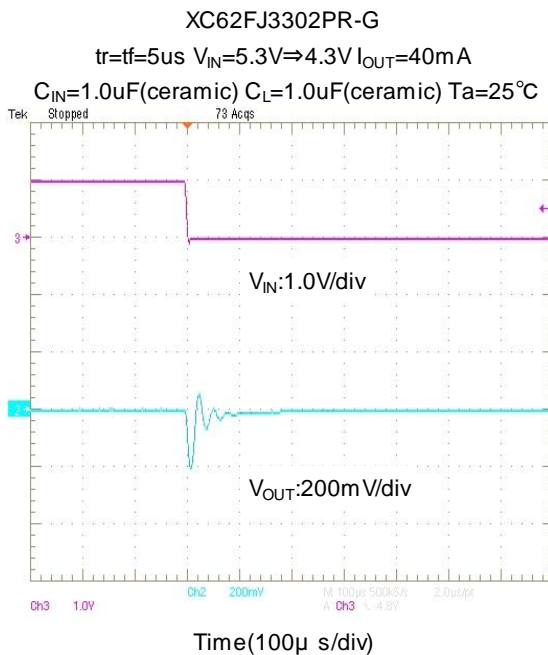
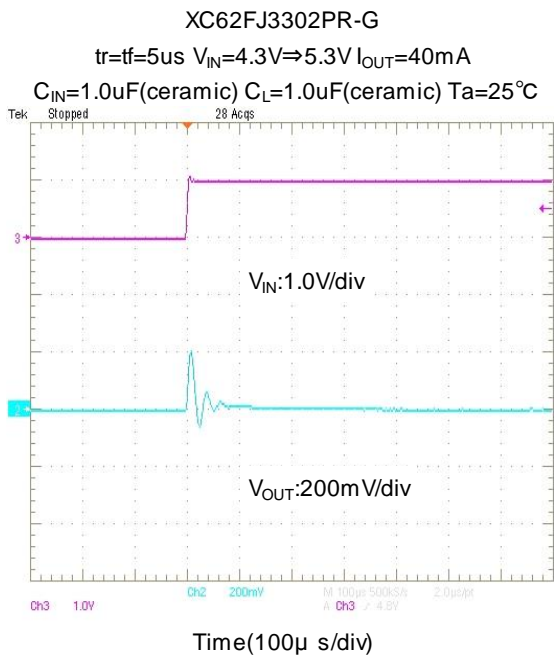

(8) Load Transient Response

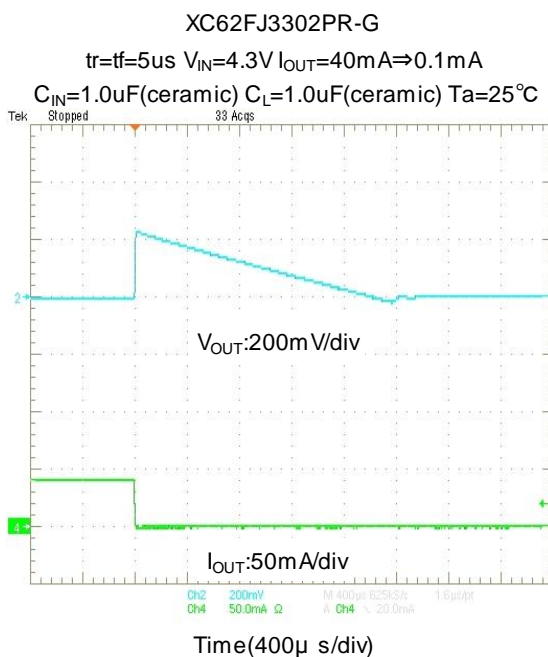
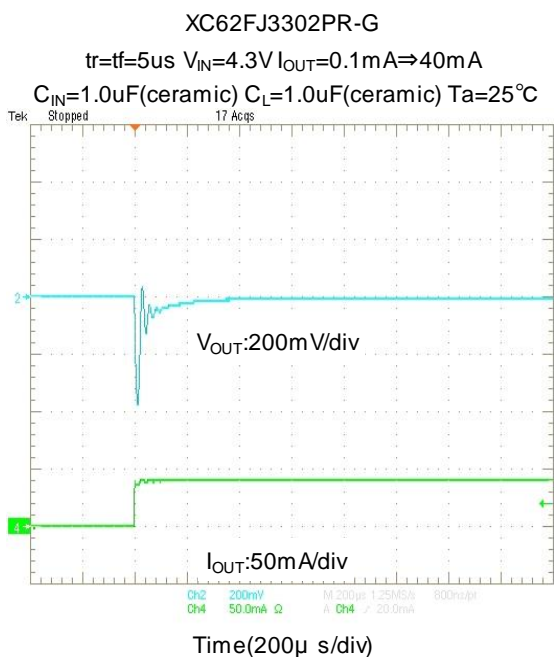

TYPICAL PERFORMANCE CHARACTERISTICS (Continued)

(9) Rising Response Time

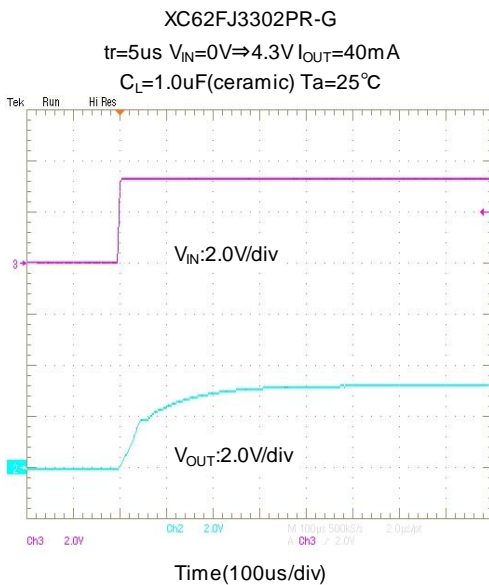
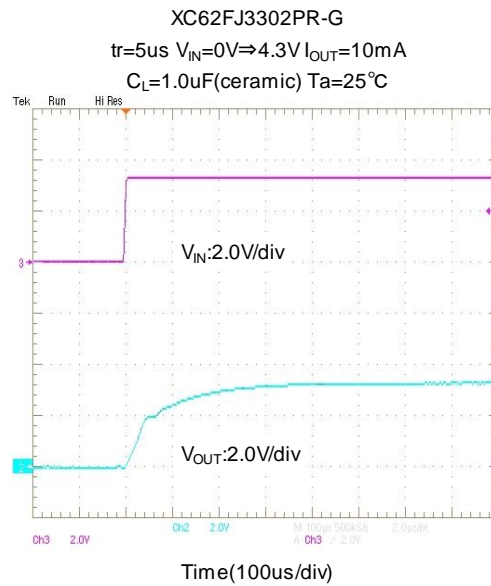
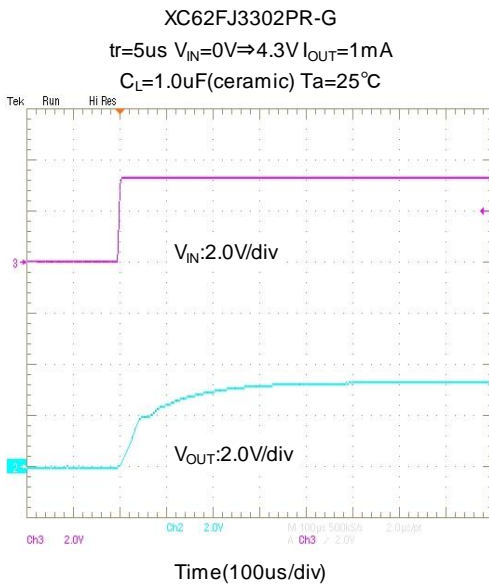

(10) Power Supply Rejection Ratio

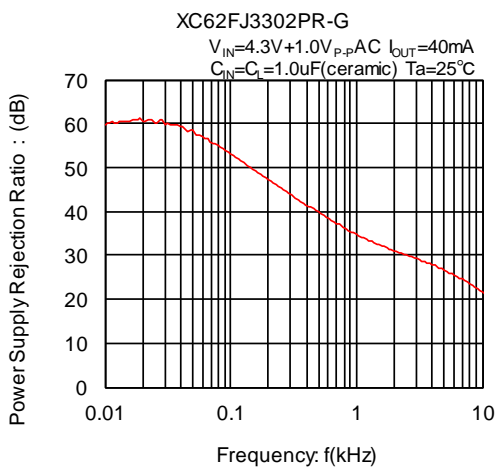

(11) Output Noise Density

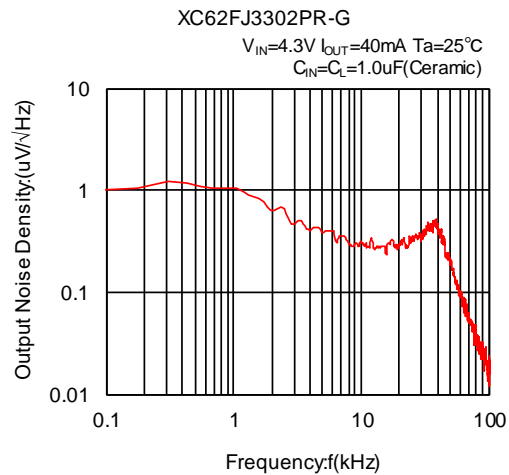

■ PACKAGING INFORMATION

For the latest package information, please visit www.torex.co.jp/technical-support/packages/

PACKAGE	OUTLINE / LAND PATTERN	THERMAL CHARACTERISTICS
SOT-89	SOT-89 PKG	SOT-89 Power Dissipation

MARKING RULE

● SOT-89

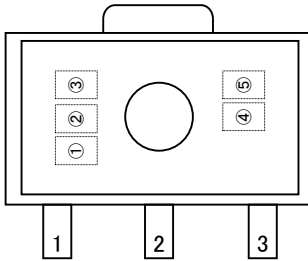

SOT-89
(TOP VIEW)

① represents product series

MARK	PRODUCT SERIES
7	XC62FJ*****-G

② represents output voltage range

MARK	OUTPUT VOLTAGE RANGE (V)	PRODUCT SERIES
0	1.7~3.0	XC62FJ*****-G
1	3.1~6.0	

③ represents output voltage range

MARK	OUTPUT VOLTAGE(V)		MARK	OUTPUT VOLTAGE(V)	
0	—	3.1	F	—	4.6
1	—	3.2	H	1.7	4.7
2	—	3.3	K	1.8	4.8
3	—	3.4	L	1.9	4.9
4	—	3.5	M	2.0	5.0
5	—	3.6	N	2.1	5.1
6	—	3.7	P	2.2	5.2
7	—	3.8	R	2.3	5.3
8	—	3.9	S	2.4	5.4
9	—	4.0	T	2.5	5.5
A	—	4.1	U	2.6	5.6
B	—	4.2	V	2.7	5.7
C	—	4.3	X	2.8	5.8
D	—	4.4	Y	2.9	5.9
E	—	4.5	Z	3.0	6.0

④,⑤ represents assembly lot number

01~09, 0A~0Z, 11~9Z, A1~A9, AA~AZ, B1~ZZ in repeated
(G, I, J, O, Q, W excluded)

* No character inversion used.

1. The product and product specifications contained herein are subject to change without notice to improve performance characteristics. Consult us, or our representatives before use, to confirm that the information in this datasheet is up to date.
2. The information in this datasheet is intended to illustrate the operation and characteristics of our products. We neither make warranties or representations with respect to the accuracy or completeness of the information contained in this datasheet nor grant any license to any intellectual property rights of ours or any third party concerning with the information in this datasheet.
3. Applicable export control laws and regulations should be complied and the procedures required by such laws and regulations should also be followed, when the product or any information contained in this datasheet is exported.
4. The product is neither intended nor warranted for use in equipment of systems which require extremely high levels of quality and/or reliability and/or a malfunction or failure which may cause loss of human life, bodily injury, serious property damage including but not limited to devices or equipment used in 1) nuclear facilities, 2) aerospace industry, 3) medical facilities, 4) automobile industry and other transportation industry and 5) safety devices and safety equipment to control combustions and explosions. Do not use the product for the above use unless agreed by us in writing in advance.
5. Although we make continuous efforts to improve the quality and reliability of our products; nevertheless Semiconductors are likely to fail with a certain probability. So in order to prevent personal injury and/or property damage resulting from such failure, customers are required to incorporate adequate safety measures in their designs, such as system fail safes, redundancy and fire prevention features.
6. Our products are not designed to be Radiation-resistant.
7. Please use the product listed in this datasheet within the specified ranges.
8. We assume no responsibility for damage or loss due to abnormal use.
9. All rights reserved. No part of this datasheet may be copied or reproduced unless agreed by Torex Semiconductor Ltd in writing in advance.

TOREX SEMICONDUCTOR LTD.

X-ON Electronics

Largest Supplier of Electrical and Electronic Components

Click to view similar products for [LDO Voltage Regulators](#) category:

Click to view products by [Torex Semiconductor](#) manufacturer:

Other Similar products are found below :

[L79M05TL-E](#) [PT7M8202B12TA5EX](#) [TCR3DF185,LM\(CT](#) [TCR3DF24,LM\(CT](#) [TCR3DF285,LM\(CT](#) [TCR3DF31,LM\(CT](#)
[TCR3DF45,LM\(CT](#) [MP2013GQ-33-Z](#) [059985X](#) [NCP4687DH15T1G](#) [701326R](#) [TCR2EN28,LF\(S](#) [NCV8170AXV250T2G](#)
[TCR3DF27,LM\(CT](#) [TCR3DF19,LM\(CT](#) [TCR3DF125,LM\(CT](#) [TCR2EN18,LF\(S](#) [AP2112R5A-3.3TRG1](#) [AP7315-25W5-7](#)
[IFX30081LDVGRNXUMA1](#) [AP2111H-1.2TRG1](#) [ZLDO1117QK50TC](#) [AZ1117ID-ADJTRG1](#) [TCR3DG12,LF](#) [MIC5514-3.3YMT-T5](#)
[MIC5512-1.2YMT-T5](#) [MIC5317-2.8YM5-T5](#) [SCD7912BTG](#) [NCP154MX180270TAG](#) [SCD33269T-5.0G](#) [NCV8170BMX330TCG](#)
[NCV8170AMX120TCG](#) [NCP706ABMX300TAG](#) [NCP153MX330180TCG](#) [NCP114BMX075TCG](#) [MC33269T-3.5G](#) [CAT6243-ADJCMT5T](#)
[TCR3DG33,LF](#) [AP2127N-1.0TRG1](#) [BD3021HFP-MTR](#) [TCR4DG35,LF](#) [LT1117CST-3.3](#) [TAR5S15U\(TE85L,F\)](#) [TAR5S18U\(TE85L,F\)](#)
[TCR3UG19A,LF](#) [TCR4DG105,LF](#) [NCV8170AMX360TCG](#) [MIC94310-NYMT-T5](#) [NCV4266-2CST33T3G](#) [NCV8186BMN175TAG](#)