

## CL Capacitor-Less 500mA Low Power Consumption High Speed LDO Regulator

### ■ GENERAL DESCRIPTION

The XC6503 series is a 500mA high speed CMOS LDO regulator that can provide stable output voltages even without a load capacitor  $C_L$ . The devices are available in fixed output voltage from 1.2V to 5.0V in 0.05V increments

The  $C_L$  capacitor-less is possible because phase compensation is carried out internally unlike other LDOs where it is done externally. It results in saving board design space. The current limit fold-back circuit and thermal shutdown circuit work as protection circuit. The XC6503P is a 3-Terminal regulator and the XC6503A/B/C/D has a chip enable function, which enables the entire circuit to be turned off by a low level input signal to the CE pin.

When a  $C_L$  capacitor is used, the IC can discharge the electric charge stored at the output capacitor through the internal switch while in standby state, and as a result the  $V_{OUT}$  quickly returns to the  $V_{SS}$  level.

### ■ APPLICATIONS

- Smart phones / Mobile phones
- Portable game consoles
- Modules (wireless, camera, etc.)
- Bluetooth modules
- Digital TV tuner modules

### ■ FEATURES

Maximum Output Current	: 500mA
Input Voltage Range	: 1.7V ~ 6.0V
Output Voltage Range	: 1.2V ~ 5.0V (0.05V increments)
Output Accuracy	: $\pm 1.0\%$ (2.0V~5.0V) $\pm 20\text{mV}$ (1.2V~1.95V)
Temperature Stability	: $\pm 30\text{ppm}/^\circ\text{C}$
Dropout Voltage	: 190mV@ $V_{OUT}=2.8\text{V}$ , $I_{OUT}=300\text{mA}$
Low Power Consumption	: 15 $\mu\text{A}$ (TYP.), 0.1 $\mu\text{A}$ (in standby)
High PSRR	: 55dB@1kHz, $V_{OUT}=2.8\text{V}$
Protection Current	: Current Limiter (630mA TYP.) Short-circuit Protection Thermal Shutdown
$C_L$ Capacitor-Less	: Internal Phase Compensation
Operating Ambient Temperature	: $-40^\circ\text{C} \sim +85^\circ\text{C}$
Packages	: USP-4, SOT-25, SOT-89-5 (XC6503A-D) SOT-89 (XC6503P)
Environmentally Friendly	: EU RoHS Compliant, Pb Free

### ■ TYPICAL APPLICATION CIRCUIT

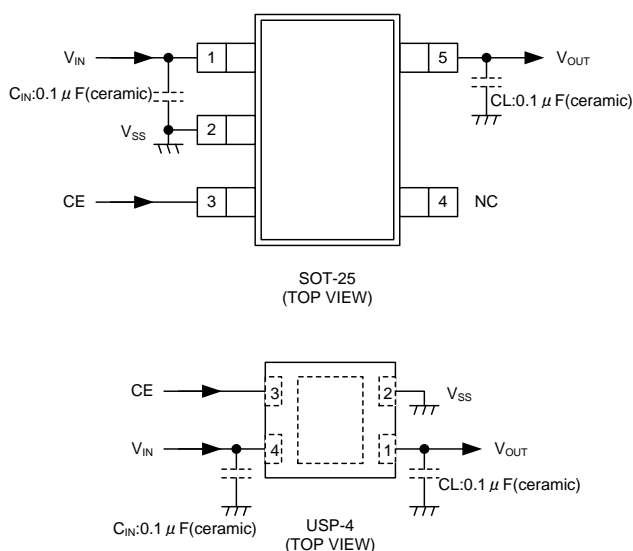

### ■ TYPICAL PERFORMANCE CHARACTERISTICS

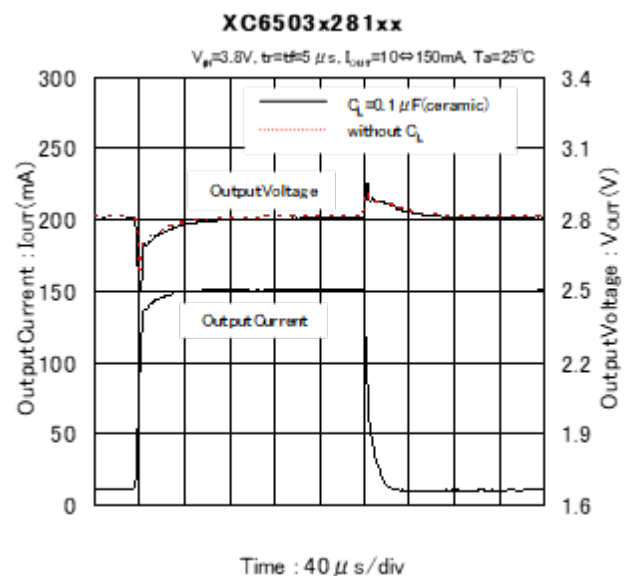

# XC6503 Series

## ■ BLOCK DIAGRAMS

XC6503 A Series

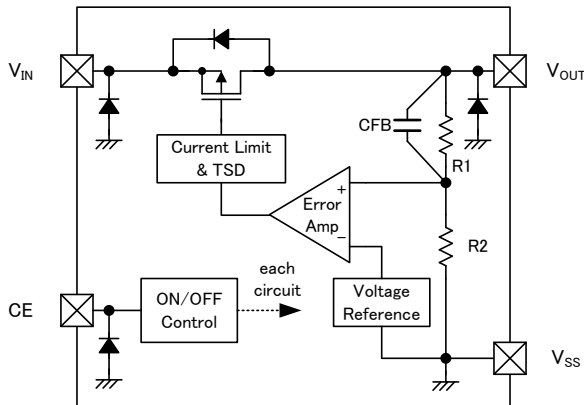

XC6503 B Series

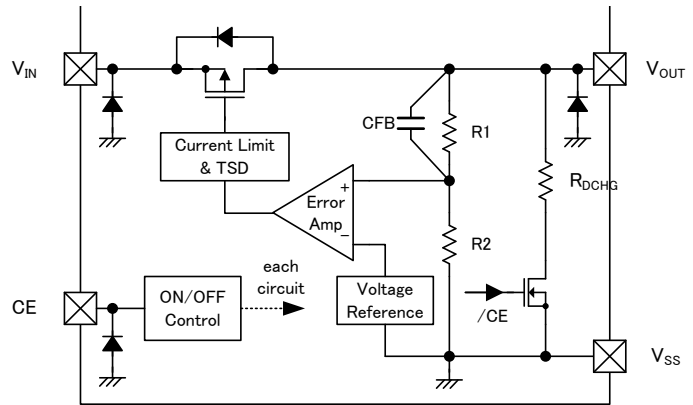

XC6503 C Series

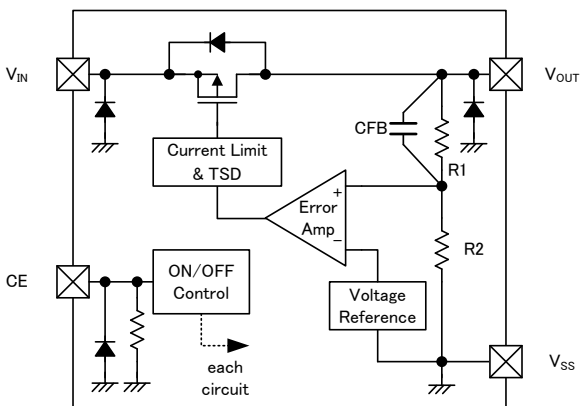

XC6503 D Series

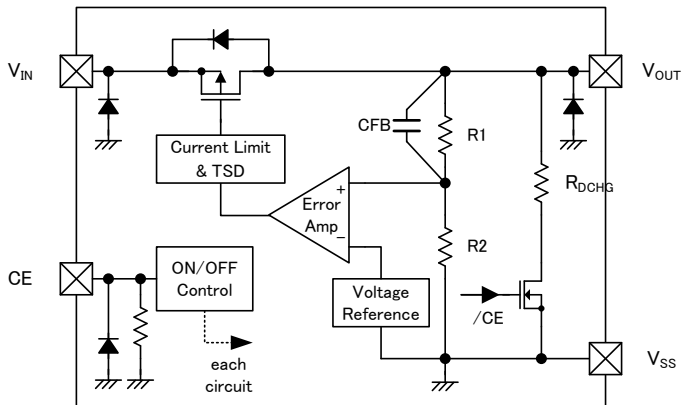

XC6503 P Series

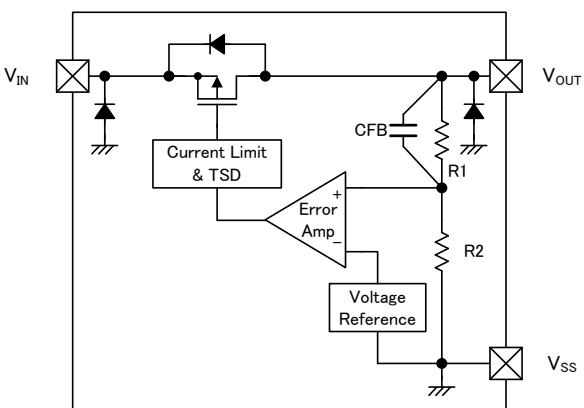

\* Diodes inside the circuits are ESD protection diodes and parasitic diodes.

## ■ PRODUCT CLASSIFICATION

### 1) Ordering Information

XC6503①②③④⑤⑥-⑦<sup>(\*)</sup>

DESIGNATOR	ITEM	SYMBOL	DESCRIPTION
①	Type of Regulator	A	Selection Guide
		B	
		C	
		D	
		P	
②③	Output Voltage	12~50	ex.) ②=2, ③=8 → 2.8V
④	Output Accuracy	1	0.1V increments
			±0.02V (1.2~1.9V)、±1% (2.0~5.0V)
			ex.) 1.80V → ②=1、③=8、④=1
		A	0.05V increments
			±0.02V(1.25~1.95V)、±1%(2.05~4.95V)
			ex.) 1.85V → ②=1、③=8、④=A
⑤⑥-⑦ <sup>(*)</sup>	Packages (Order Unit)	GR-G	USP-4 (3,000pcs/Reel) *A/B/C/D Type
		MR-G	SOT-25 (3,000pcs/Reel) *A/B/C/D Type
		PR-G	SOT-89 (1,000pcs/Reel) * P Type
			SOT-89-5 (1,000pcs/Reel) *A/B/C/D Type

(\*) The "-G" suffix denotes Halogen and Antimony free as well as being fully EU RoHS compliant.

### 2) Selection Guide

TYPE	CURRENT LIMITER	SHORT PROTECTION	THERMAL SHUTDOWN PROTECTION	CE Pull-down RESISTOR	C <sub>L</sub> DISCHARGE	CE PIN
A	Yes	Yes	Yes	No	No	Yes
B	Yes	Yes	Yes	No	Yes	Yes
C	Yes	Yes	Yes	Yes	No	Yes
D	Yes	Yes	Yes	Yes	Yes	Yes
P	Yes	Yes	Yes	No	No	No

## PIN CONFIGURATION

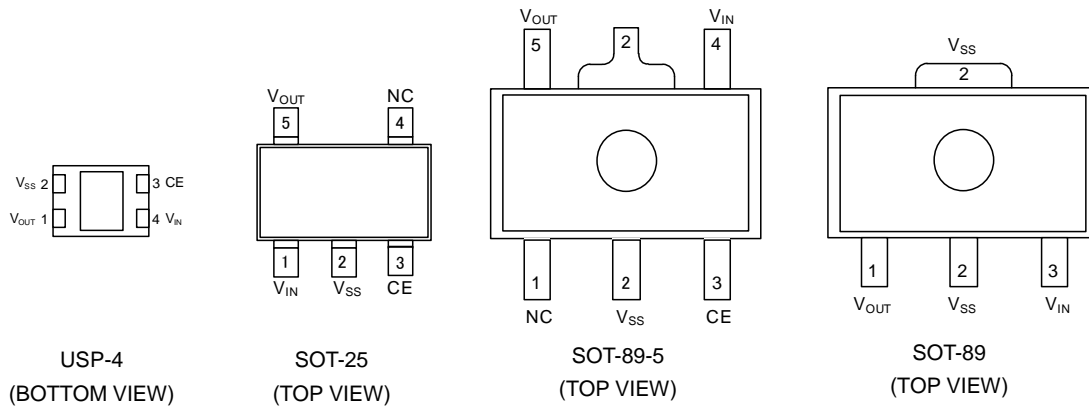

\*The dissipation pad for the USP-4 package should be solder-plated in reference mount pattern and metal masking so as to enhance mounting strength and heat release. If the pad needs to be connected to other pins, it should be connected to the  $V_{SS}$  (No. 2) pin.

## PIN ASSIGNMENT

PIN NUMBER				PIN NAME	FUNCTIONS
USP-4	SOT-25	SOT89-5	SOT-89		
4	1	4	3	$V_{IN}$	Power Input
1	5	5	1	$V_{OUT}$	Output
2	2	2	2	$V_{SS}$	Ground
3	3	3	-	CE	ON/OFF Control
-	4	1	-	NC	No Connection

## PIN FUNCTION ASSIGNMENT

XC6503 Series (A/B Type)

PIN NAME	LOGIC	IC OPERATION
CE	L	Operation OFF
	H	Operation ON
	OPEN	Unstable

XC6503 Series (C/D Type)

PIN NAME	LOGIC	IC OPERATION
CE	L	Operation OFF
	H	Operation ON
	OPEN	Operation OFF

\* Please avoid the state of OPEN, and connect CE pin to any arbitrary voltage.

## ■ ABSOLUTE MAXIMUM RATINGS

Ta=25°C

PARAMETER		SYMBOL	RATINGS	UNITS
Input Voltage		V <sub>IN</sub>	V <sub>SS</sub> -0.3~V <sub>SS</sub> +6.5	V
Output Current		I <sub>OUT</sub>	850 <sup>(*)</sup>	mA
Output Voltage		V <sub>OUT</sub>	V <sub>SS</sub> -0.3~V <sub>IN</sub> +0.3 ≤ V <sub>SS</sub> +6.5	V
CE Input Voltage		V <sub>CE</sub>	V <sub>SS</sub> -0.3~V <sub>SS</sub> +6.5	V
Power Dissipation	USP-4	Pd	120	mW
			1000(40mm x 40mm Standard) <sup>(**)</sup>	
	SOT-25		250	
			600(40mm x 40mm Standard) <sup>(**)</sup>	
	SOT-89		500	
			1000(40mm x 40mm Standard) <sup>(**)</sup>	
	SOT-89-5		500	
1300(40mm x 40mm Standard) <sup>(**)</sup>				
Operating Ambient Temperature		Topr	-40~+85	°C
Storage Temperature		Tstg	-55~+125	°C

<sup>(\*)</sup> Pd > (V<sub>IN</sub>-V<sub>OUT</sub>) × I<sub>OUT</sub>

<sup>(\*\*)</sup> The power dissipation figure shown is PCB mounted and is for reference only  
The mounting condition is please refer to PACKAGING INFORMATION.

## ELECTRICAL CHARACTERISTICS

### ●XC6503 A/B/C/D Type

Ta=25°C

PARAMETER	SYMBOL	CONDITIONS	MIN.	TYP.	MAX.	UNITS	CIRCUITS	
Output Voltage	$V_{OUT(E)}$ <sup>(2)</sup>	$2.0V > V_{OUT(T)}$ <sup>(3)</sup> , $V_{CE}=V_{IN}$ , $I_{OUT}=10mA$	-0.02 <sup>(4)</sup>	$V_{OUT(T)}$	+0.02 <sup>(4)</sup>	V	①	
		$2.0V \leq V_{OUT(T)}$ , $V_{CE}=V_{IN}$ , $I_{OUT}=10mA$	$\times 0.99$ <sup>(4)</sup>		$\times 1.01$ <sup>(4)</sup>			
Maximum Output Current	$I_{OUTMAX}$	$V_{CE}=V_{IN}$	500	-	-	mA	①	
Load Regulation	$\Delta V_{OUT}$	$V_{CE}=V_{IN}$ , $0.1mA \leq I_{OUT} \leq 300mA$	-	20	50	mV	①	
Dropout Voltage <sup>(5)</sup>	$V_{dif}$	$V_{CE}=V_{IN}$ , $I_{OUT}=300mA$	-	E-1 <sup>(6)</sup>		mV	①	
Supply Current	$I_{SS}$	$V_{IN}=V_{CE}=6.0V$ , $I_{OUT}=0mA$	-	15	30	$\mu A$	②	
Stand-by Current	$I_{STB}$	$V_{IN}=6.0V$ , $V_{CE}=V_{SS}$	-	0.01	0.1	$\mu A$	②	
Line Regulation	$\frac{\Delta V_{OUT}}{(\Delta V_{IN} \cdot V_{OUT})}$	$V_{OUT(T)}+0.5V \leq V_{IN} \leq 6.0V$ , $V_{CE}=V_{IN}$ , $I_{OUT}=30mA$	-	E-2 <sup>(9)</sup>		%/V	①	
Input Voltage	$V_{IN}$		1.7	-	6.0	V	①	
Output Voltage Temperature Characteristics	$\frac{\Delta V_{OUT}}{(\Delta T_{opr} \cdot V_{OUT})}$	$V_{CE}=V_{IN}$ , $I_{OUT}=30mA$ $-40^{\circ}C \leq T_{opr} \leq 85^{\circ}C$	-	$\pm 30$	-	ppm/ $^{\circ}C$	①	
Power Supply Rejection Ratio	PSRR	$V_{OUT(T)} \leq 4.75V$ $V_{IN} = \{V_{OUT(T)} + 1.0\} V_{DC} + 0.5V_{p-pAC}$ $V_{CE}=V_{IN}$ , $I_{OUT}=30mA$ , $f=1kHz$	-	55	-	dB	③	
		$V_{OUT(T)} \geq 4.80V$ $V_{IN} = 5.75V_{DC} + 0.5V_{p-pAC}$ $V_{CE}=V_{IN}$ , $I_{OUT}=30mA$ , $f=1kHz$						
Current Limit	$I_{LIM}$	$V_{CE}=V_{IN}$	510	630	750	mA	①	
Short-circuit Current	$I_{SHORT}$	$V_{CE}=V_{IN}$ Short $V_{OUT}$ to $V_{SS}$ level	-	120	210	mA	①	
CE High Level Voltage	$V_{CEH}$		1.0	-	6.0	V	①	
CE Low Level Voltage	$V_{CEL}$		$V_{SS}$	-	0.3	V	①	
CE High Level Current	$I_{CEH}$	$V_{IN}=V_{CE}=6.0V$	A/B type	-0.1	-	0.1	$\mu A$	①
			C/D type	3.5	6	10		
CE Low Level Current	$I_{CEL}$	$V_{CE}=V_{SS}$	-0.1	-	0.1	$\mu A$	①	
$C_L$ Discharge Resistance <sup>(10)</sup>	$R_{DCHG}$	$V_{IN}=6.0V$ , $V_{OUT}=5.0V$ , $V_{CE}=V_{SS}$	300	430	500	$\Omega$	①	
Thermal Shutdown Detect Temperature	$T_{TSD}$	Junction Temperature	-	150	-	$^{\circ}C$	-	
Thermal Shutdown Release Temperature	$T_{TSR}$	Junction Temperature	-	125	-	$^{\circ}C$	-	
Thermal Shutdown Hysteresis Width	$T_{HYS}$	$T_{TSD}-T_{TSR}$	-	25	-	$^{\circ}C$	-	

#### NOTE:

<sup>(1)</sup> Unless otherwise stated regarding input voltage conditions,  $V_{IN}=V_{OUT(T)}$  <sup>(3)</sup>+1.0V.

<sup>(2)</sup>  $V_{OUT(E)}$ : Effective output voltage  
(i.e. the output voltage when " $V_{OUT(T)}+1.0V$ " is provided at the  $V_{IN}$  pin while maintaining a certain  $I_{OUT}$  value.)

<sup>(3)</sup>  $V_{OUT(T)}$ : Nominal output voltage

<sup>(4)</sup> Characteristics of the actual  $V_{OUT(E)}$  by setting output voltage is shown in the voltage chart.

<sup>(5)</sup>  $V_{dif}=V_{IN1}$  <sup>(7)</sup>- $V_{OUT1}$  <sup>(6)</sup>

<sup>(6)</sup>  $V_{OUT1}$  is a voltage equal to 98% of the output voltage whenever an amply stabilized  $I_{OUT}$  ( $V_{OUT(T)}+1.0V$ ) is input

<sup>(7)</sup>  $V_{IN1}$  is an input voltage when  $V_{OUT1}$  appears at the  $V_{OUT}$  pin while the input voltage is gradually decreased.

<sup>(8)</sup> E-1:DROPOUT VOLTAGE (Refer to Voltage Chart.)

<sup>(9)</sup> E-2:LINE REGULATION (Refer to Voltage Chart.)

<sup>(10)</sup> This function is built in the XC6503B/D series only.

The XC6503A/C series discharges by only R1+ R2 resistors as shown in the block diagrams.

## ■ ELECTRICAL CHARACTERISTICS (Continued)

● XC6503P Type

Ta=25°C

PARAMETER	SYMBOL	CONDITIONS	MIN.	TYP.	MAX.	UNITS	CIRCUITS
Output Voltage	V <sub>OUT(E)</sub> <sup>(2)</sup>	2.0V > V <sub>OUT(T)</sub> <sup>(3)</sup> , I <sub>OUT</sub> =10mA	-0.02 <sup>(4)</sup>	V <sub>OUT(T)</sub>	+0.02 <sup>(4)</sup>	V	①
		2.0V ≤ V <sub>OUT(T)</sub> , I <sub>OUT</sub> =10mA	x0.99 <sup>(4)</sup>		x1.01 <sup>(4)</sup>		
Maximum Output Current	I <sub>OUTMAX</sub>		500	-	-	mA	①
Load Regulation	ΔV <sub>OUT</sub>	0.1mA ≤ I <sub>OUT</sub> ≤ 300mA	-	20	50	mV	①
Dropout Voltage <sup>(5)</sup>	V <sub>dif</sub>	I <sub>OUT</sub> =300mA	-	E-1 <sup>(8)</sup>		mV	①
Supply Current	I <sub>SS</sub>	V <sub>IN</sub> = 6.0V, I <sub>OUT</sub> =0mA	-	15	30	μA	②
Line Regulation	ΔV <sub>OUT</sub> / (ΔV <sub>IN</sub> · V <sub>OUT</sub> )	V <sub>OUT(T)</sub> +0.5V ≤ V <sub>IN</sub> ≤ 6.0V, I <sub>OUT</sub> =30mA	-	E-2 <sup>(9)</sup>		%/V	①
Input Voltage	V <sub>IN</sub>		1.7	-	6.0	V	①
Output Voltage Temperature Characteristics	ΔV <sub>OUT</sub> / (ΔT <sub>opr</sub> · V <sub>OUT</sub> )	I <sub>OUT</sub> =30mA -40°C ≤ T <sub>opr</sub> ≤ 85°C	-	±30	-	ppm/°C	①
Power Supply Rejection Ratio	PSRR	V <sub>OUT(T)</sub> ≤ 4.75V V <sub>IN</sub> = {V <sub>OUT(T)</sub> +1.0} V <sub>DC</sub> +0.5V <sub>p-pAC</sub> I <sub>OUT</sub> =30mA, f=1kHz	-	55	-	dB	③
		V <sub>OUT(T)</sub> ≥ 4.80V V <sub>IN</sub> = 5.75V <sub>DC</sub> +0.5V <sub>p-pAC</sub> I <sub>OUT</sub> =30mA, f=1kHz					
Current Limit	I <sub>LIM</sub>		510	630	750	mA	①
Short-circuit Current	I <sub>SHORT</sub>	Short V <sub>OUT</sub> to V <sub>SS</sub> level	-	120	210	mA	①
Thermal Shutdown Detect Temperature	T <sub>TSD</sub>	Junction Temperature	-	150	-	°C	-
Thermal Shutdown Release Temperature	T <sub>TSR</sub>	Junction Temperature	-	125	-	°C	-
Thermal Shutdown Hysteresis Width	T <sub>HYS</sub>	T <sub>TSD</sub> -T <sub>TSR</sub>	-	25	-	°C	-

NOTE:

(<sup>1</sup>) Unless otherwise stated regarding input voltage conditions, V<sub>IN</sub>=V<sub>OUT(T)</sub><sup>(3)</sup>+1.0V.

(<sup>2</sup>) V<sub>OUT(E)</sub>: Effective output voltage

(i.e. the output voltage when "V<sub>OUT(T)</sub>+1.0V" is provided at the V<sub>IN</sub> pin while maintaining a certain I<sub>OUT</sub> value.)

(<sup>3</sup>) V<sub>OUT(T)</sub>: Nominal output voltage

(<sup>4</sup>) Characteristics of the actual V<sub>OUT(E)</sub> by setting output voltage is shown in the voltage chart.

(<sup>5</sup>) V<sub>dif</sub>=V<sub>IN1</sub><sup>(7)</sup>-V<sub>OUT1</sub><sup>(6)</sup>

(<sup>6</sup>) V<sub>OUT1</sub> is a voltage equal to 98% of the output voltage whenever an amply stabilized I<sub>OUT</sub> {V<sub>OUT(T)</sub>+1.0V} is input

(<sup>7</sup>) V<sub>IN1</sub> is an input voltage when V<sub>OUT1</sub> appears at the V<sub>OUT</sub> pin while the input voltage is gradually decreased.

(<sup>8</sup>) E-1:DROPOUT VOLTAGE (Refer to Voltage Chart.)

(<sup>9</sup>) E-2:LINE REGULATION (Refer to Voltage Chart.)

# XC6503 Series

## ELECTRICAL CHARACTERISTICS (Continued)

### ● Voltage Chart

Ta=25°C

NOMINAL VOLTAGE (V)	E-0		E-1		E-2		NOMINAL VOLTAGE (V)	E-0		E-1		E-2	
	OUTPUT VOLTAGE (V)		DROPOUT VOLTAGE (mV)		LINE REGULATION (%/V)			OUTPUT VOLTAGE (V)		DROPOUT VOLTAGE (mV)		LINE REGULATION (%/V)	
	V <sub>OUT(E)</sub>		V <sub>dif</sub>		ΔV <sub>OUT</sub> / (ΔV <sub>IN</sub> ·V <sub>OUT</sub> )			V <sub>OUT(E)</sub>		V <sub>dif</sub>		ΔV <sub>OUT</sub> / (ΔV <sub>IN</sub> ·V <sub>OUT</sub> )	
V <sub>OUT(T)</sub>	MIN.	MAX.	TYP.	MAX.	TYP.	MAX.	V <sub>OUT(T)</sub>	MIN.	MAX.	TYP.	MAX.	TYP.	MAX.
1.200	1.1800	1.2200	555	660	0.1	0.25	3.150	3.1185	3.1815	190	250	0.1	0.2
1.250	1.2300	1.2700	↑	↑	↑	↑	3.200	3.1680	3.2320	170	230	↑	↑
1.300	1.2800	1.3200	↑	↑	↑	0.2	3.250	3.2175	3.2825	↑	↑	↑	↑
1.350	1.3300	1.3700	↑	↑	↑	↑	3.300	3.2670	3.3330	↑	↑	↑	↑
1.400	1.3800	1.4200	440	560	↑	↑	3.350	3.3165	3.3835	↑	↑	↑	↑
1.450	1.4300	1.4700	↑	↑	↑	↑	3.400	3.3660	3.4340	↑	↑	↑	↑
1.500	1.4800	1.5200	↑	↑	↑	↑	3.450	3.4155	3.4845	↑	↑	↑	↑
1.550	1.5300	1.5700	↑	↑	↑	↑	3.500	3.4650	3.5350	↑	↑	↑	↑
1.600	1.5800	1.6200	360	450	↑	↑	3.550	3.5145	3.5855	↑	↑	↑	↑
1.650	1.6300	1.6700	↑	↑	↑	↑	3.600	3.5640	3.6360	155	210	↑	↑
1.700	1.6800	1.7200	↑	↑	↑	↑	3.650	3.6135	3.6865	↑	↑	↑	↑
1.750	1.7300	1.7700	↑	↑	↑	↑	3.700	3.6630	3.7370	↑	↑	↑	↑
1.800	1.7800	1.8200	300	390	↑	↑	3.750	3.7125	3.7875	↑	↑	↑	↑
1.850	1.8300	1.8700	↑	↑	↑	↑	3.800	3.7620	3.8380	↑	↑	↑	↑
1.900	1.8800	1.9200	↑	↑	↑	↑	3.850	3.8115	3.8885	↑	↑	↑	↑
1.950	1.9300	1.9700	↑	↑	↑	↑	3.900	3.8610	3.9390	↑	↑	↑	↑
2.000	1.9800	2.0200	265	330	↑	↑	3.950	3.9105	3.9895	↑	↑	↑	↑
2.050	2.0295	2.0705	↑	↑	↑	↑	4.000	3.9600	4.0400	↑	↑	↑	↑
2.100	2.0790	2.1210	↑	↑	↑	↑	4.050	4.0095	4.0905	↑	↑	↑	↑
2.150	2.1285	2.1715	↑	↑	↑	↑	4.100	4.0590	4.1410	↑	↑	↑	↑
2.200	2.1780	2.2220	240	310	↑	↑	4.150	4.1085	4.1915	↑	↑	↑	↑
2.250	2.2275	2.2725	↑	↑	↑	↑	4.200	4.1580	4.2420	140	195	↑	↑
2.300	2.2770	2.3230	↑	↑	↑	↑	4.250	4.2075	4.2925	↑	↑	↑	↑
2.350	2.3265	2.3735	↑	↑	↑	↑	4.300	4.2570	4.3430	↑	↑	↑	↑
2.400	2.3760	2.4240	↑	↑	↑	↑	4.350	4.3065	4.3935	↑	↑	↑	↑
2.450	2.4255	2.4745	↑	↑	↑	↑	4.400	4.3560	4.4440	↑	↑	↑	↑
2.500	2.4750	2.5250	210	270	↑	↑	4.450	4.4055	4.4945	↑	↑	↑	↑
2.550	2.5245	2.5755	↑	↑	↑	↑	4.500	4.4550	4.5450	↑	↑	↑	↑
2.600	2.5740	2.6260	↑	↑	↑	↑	4.550	4.5045	4.5955	↑	↑	↑	↑
2.650	2.6235	2.6765	↑	↑	↑	↑	4.600	4.5540	4.6460	↑	↑	↑	↑
2.700	2.6730	2.7270	↑	↑	↑	↑	4.650	4.6035	4.6965	↑	↑	↑	↑
2.750	2.7225	2.7775	↑	↑	↑	↑	4.700	4.6530	4.7470	↑	↑	↑	↑
2.800	2.7720	2.8280	190	250	↑	↑	4.750	4.7025	4.7975	↑	↑	↑	↑
2.850	2.8215	2.8785	↑	↑	↑	↑	4.800	4.7520	4.8480	↑	↑	↑	↑
2.900	2.8710	2.9290	↑	↑	↑	↑	4.850	4.8015	4.8985	↑	↑	↑	↑
2.950	2.9205	2.9795	↑	↑	↑	↑	4.900	4.8510	4.9490	↑	↑	↑	↑
3.000	2.9700	3.0300	↑	↑	↑	↑	4.950	4.9005	4.9995	↑	↑	↑	↑
3.050	3.0195	3.0805	↑	↑	↑	↑	5.000	4.9500	5.0500	↑	↑	↑	↑
3.100	3.0690	3.1310	↑	↑	↑	↑							



## ■ TEST CIRCUITS

● Circuit ①

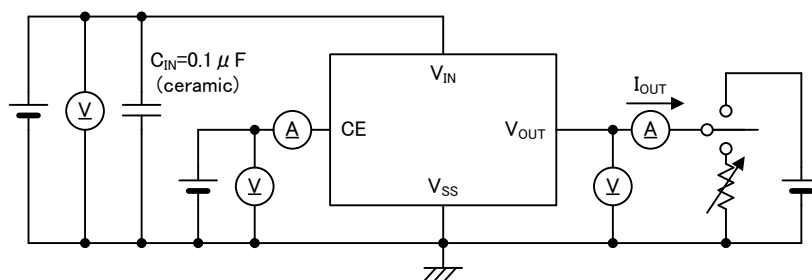

● Circuit ②

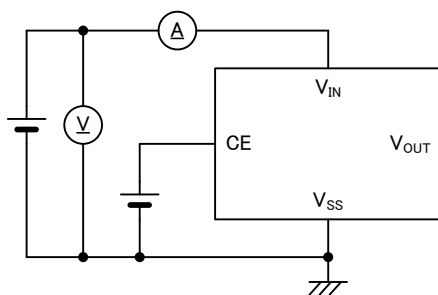

● Circuit ③

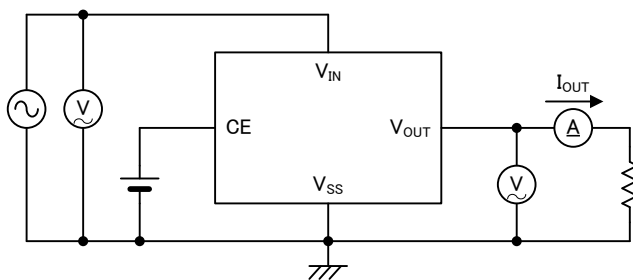

\* For the XC6503P series, CE pin is connected to the  $V_{IN}$  internally.

## OPERATIONAL EXPLANATION

The voltage divided by resistors R1 and R2 is compared with the internal reference voltage by the error amplifier. The P-channel MOSFET which is connected to the V<sub>OUT</sub> pin is then driven by the subsequent output signal. The output voltage at the V<sub>OUT</sub> pin is controlled and stabilized by a system of negative feedback. The current limit circuit and short circuit protection operate in relation to the level of output current and heat dissipation. Current limit circuit and short protection circuit operate with output current and thermal shutdown circuit will operate with heating. Further, the IC's internal circuitry can be shutdown via the CE pin signal.

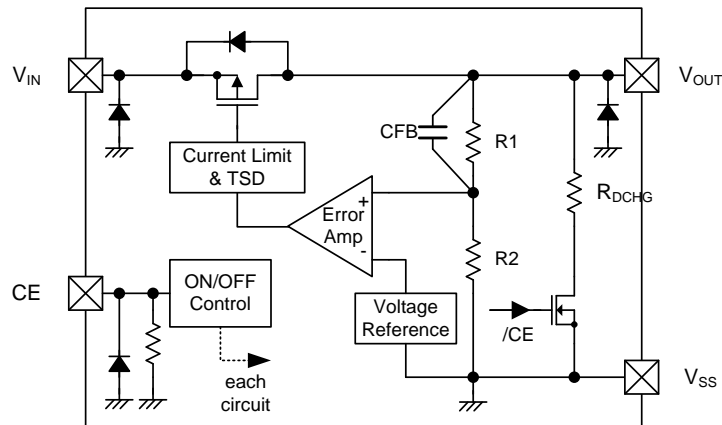

XC6503 Series D Type

XC6503D Series

### <C<sub>L</sub> Auto-Discharge Function>

XC6503 B/D can quickly discharge the electric charge at the output capacitor (C<sub>L</sub>), when a low signal to the CE pin, which enables a whole IC circuit put into OFF state, is inputted via the N-channel transistor located between the V<sub>OUT</sub> pin and the V<sub>SS</sub> pin (cf. BLOCK DIAGRAM). The C<sub>L</sub> discharge resistance is set to 430Ω when V<sub>IN</sub> is 6.0V (TYP.) and V<sub>OUT</sub> is 5.0V (TYP.). Moreover, discharge time of the output capacitor (C<sub>L</sub>) is set by the C<sub>L</sub> auto-discharge resistance (R<sub>DCHG</sub>) and the output capacitor (C<sub>L</sub>). By setting time constant of a C<sub>L</sub> auto-discharge resistance value (R<sub>DCHG</sub>) and an output capacitor value (C<sub>L</sub>) as  $\tau$  ( $\tau = C \times R$ ), the output voltage after discharge via the N-channel transistor is calculated by the following formula.

$$V = V_{OUT(E)} \times e^{-t/\tau}, \quad \text{or } t = \tau \ln(V_{OUT(E)} / V)$$

( V : Output voltage after discharge, V<sub>OUT(E)</sub> : Initial Output voltage, t: Discharge time,  
 $\tau$  : C<sub>L</sub> auto-discharge resistance R<sub>DCHG</sub> × C<sub>L</sub> Output capacitance

### <Current Limiter, Short-Circuit Protection>

The protection circuit operates as a combination of an output current limiter and fold-back short circuit protection. When load current reaches the current limit level, the output voltage drops. As a result, the load current starts to reduce with showing fold-back curve. The output current finally falls at the level of 120mA when the V<sub>OUT</sub> pin is short-circuited.

### <Thermal Shutdown>

When the junction temperature of the built-in driver transistor reaches the temperature limit, the thermal shutdown circuit operates and the driver transistor will be set to OFF. The IC resumes its operation when the thermal shutdown function is released and the IC's operation is automatically restored because the junction temperature drops to the level of the thermal shutdown release voltage.

### <CE Pin>

The IC's internal circuitry can be shutdown via the signal from the CE pin with the XC6503 A/B/C/D series. In shutdown mode, output at the V<sub>OUT</sub> pin will be pulled down to the V<sub>SS</sub> level via R1, R2 and C<sub>L</sub> auto-discharge resistance R<sub>DCHG</sub>. Please note the XC6503P does not have the CE pin.

The XC6503 C/D has a pulled down resistor at the CE pin in order to avoid an unstable operation with the CE pin open (the CE pin is left open, operation will be stopped). However, the CE pin input current will increase slightly through the pulled down resistor when operating. If the correct output voltage is applied to the CE pin, the logic is fixed and the IC will operate normally. However, if the medium voltage is input, supply current may increase as a result of an internal through current.

## ■ NOTES ON USE

1. For temporary, transitional voltage drop or voltage rising phenomenon, the IC is liable to malfunction should the ratings be exceeded.
2. The XC6503 series operates even if without attaching an output capacitor. However, when wiring impedance is high, operations may become unstable due to noise and/or phase lag depending on output current. Please wire the input capacitor ( $C_{IN}$ ) and the output capacitor ( $C_L$ ) as close to the IC as possible.
3. The XC6503 installs fold-back current limit circuits. When start-up, this fold-back load curve affects its start-up characteristics. The XC6503 having output current under 2.4V and Load Resistance ( $R_{LOAD}$ )  $\geq 4.8\Omega$  may not happen to start-up with the load conditions below. In these cases, sequence control should be taken for connecting a load after the start-up execution.

Start-up Condition : Load Resistance  $R_{LOAD} \geq 4.8\Omega$

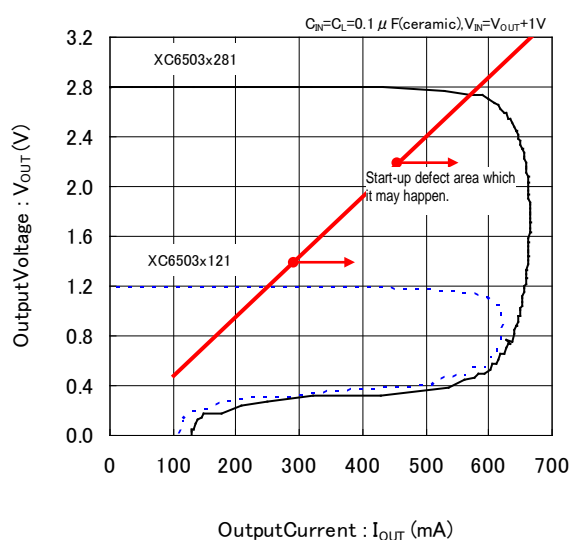

### ●CONDITION

Output Voltage	Load Resistance	Output Current
1.2V	$\geq 4.8\Omega$	$\leq 250mA$
1.5V	$\geq 4.8\Omega$	$\leq 312mA$
1.8V	$\geq 4.8\Omega$	$\leq 375mA$

4. Torex places an importance on improving our products and its reliability. However, by any possibility, we would request user fail-safe design and post-aging treatment on system or equipment.

## TYPICAL PERFORMANCE CHARACTERISTICS

### (1) OutputVoltage v.s. OutputCurrent

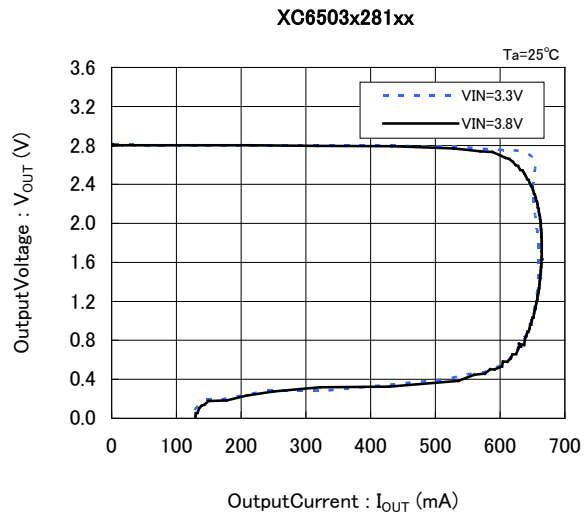
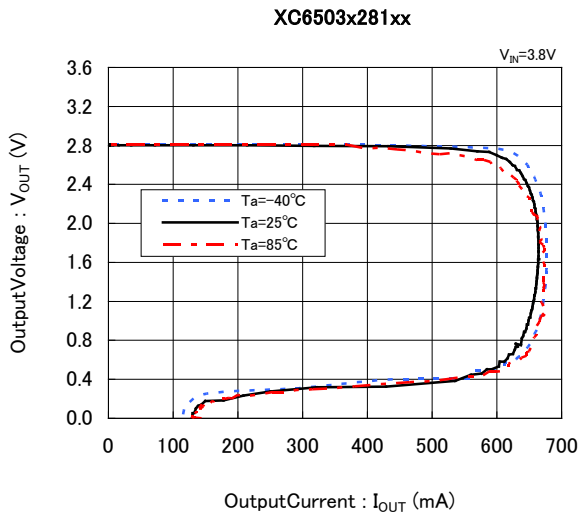
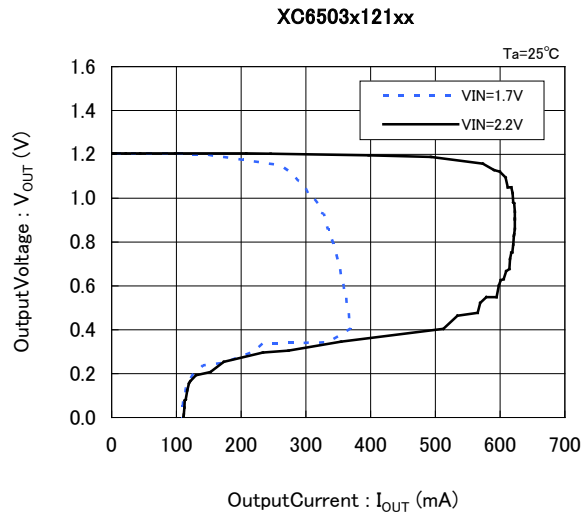
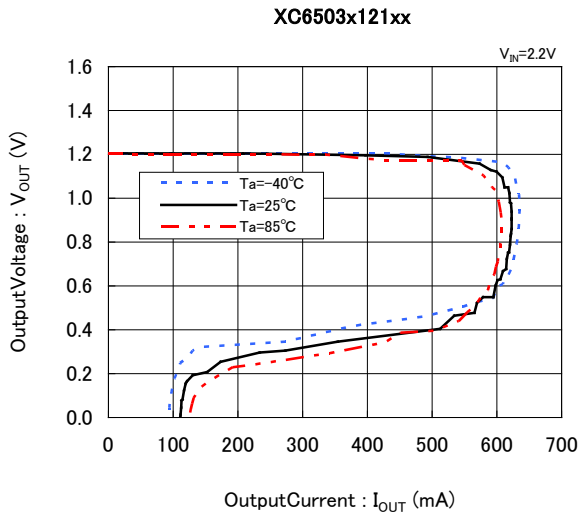

### (2) OutputVoltage v.s. InputVoltage

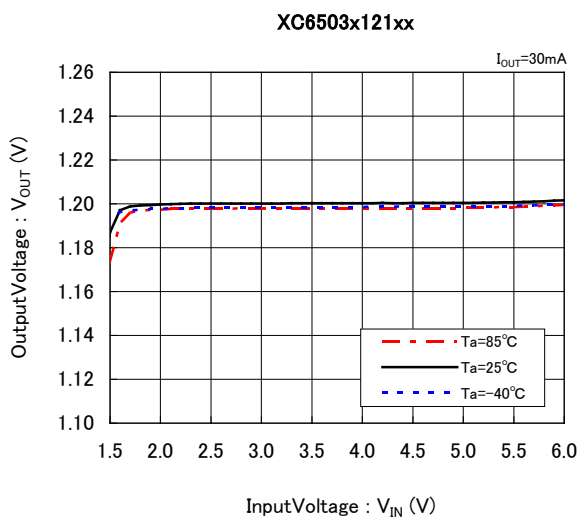
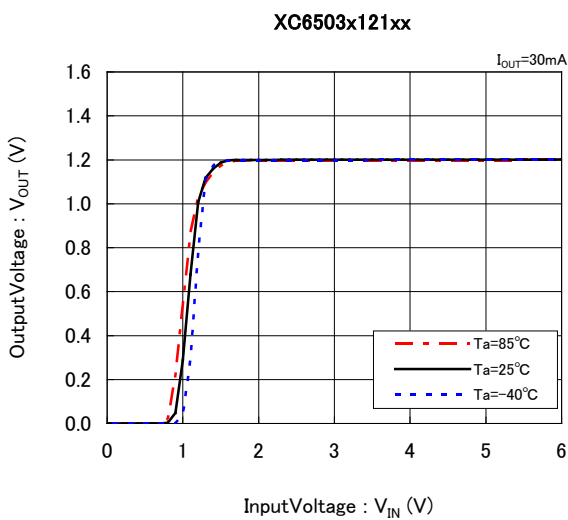

## ■ TYPICAL PERFORMANCE CHARACTERISTICS (Continued)

### (2) OutputVoltage v.s. InputVoltage

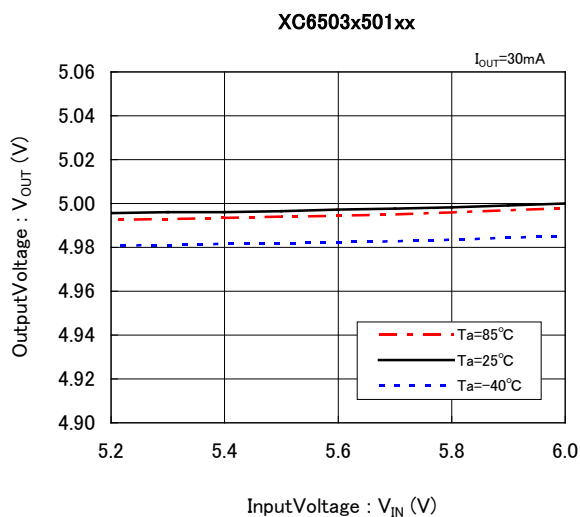
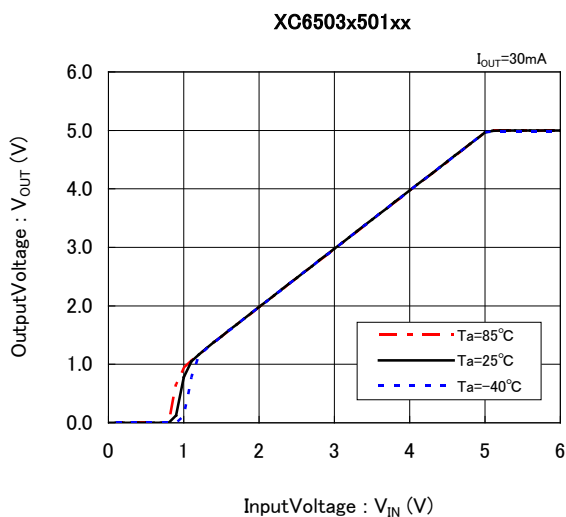
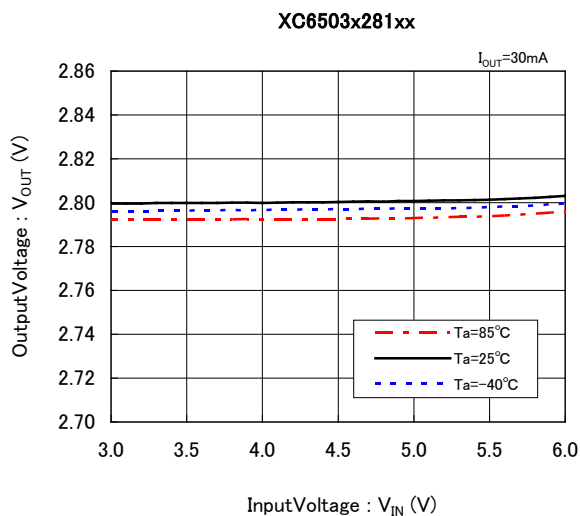
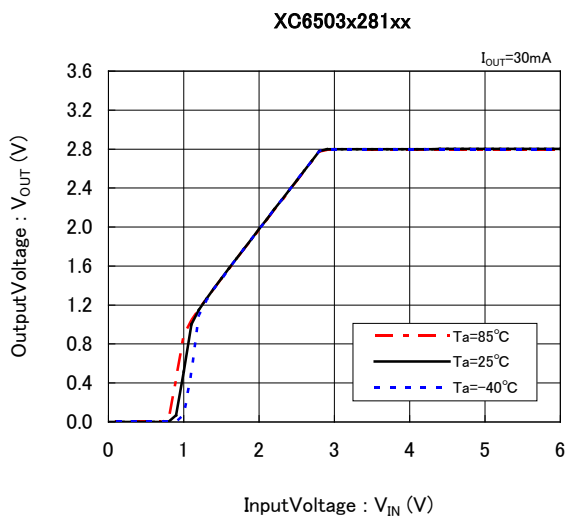

### (3) DropoutVoltage v.s. OutputCurrent

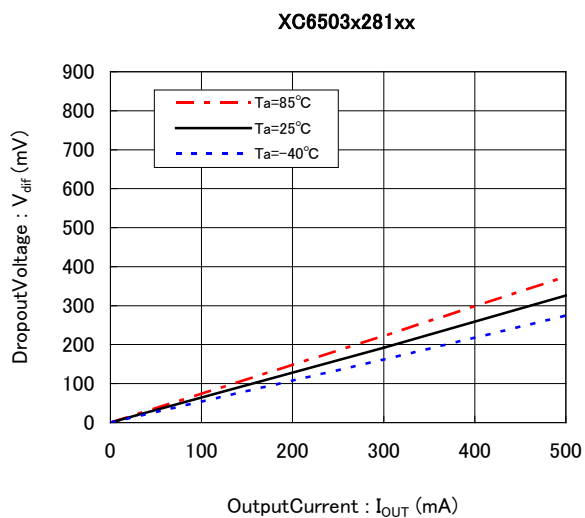
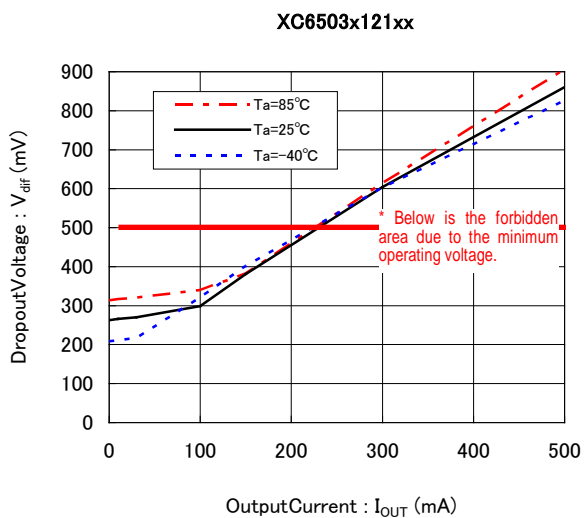

## TYPICAL PERFORMANCE CHARACTERISTICS (Continued)

### (3) Dropout Voltage v.s. Output Current

XC6503x501xx

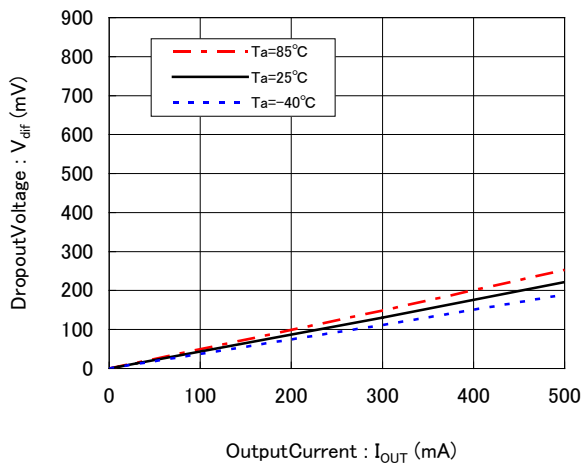

### (4) Supply Current v.s. Input Voltage

XC6503x121xx

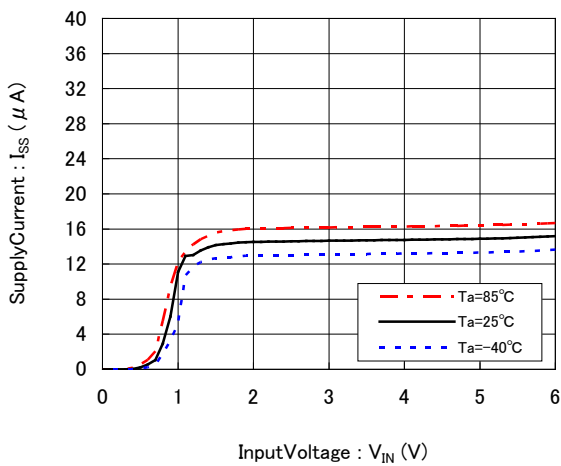

XC6503x281xx

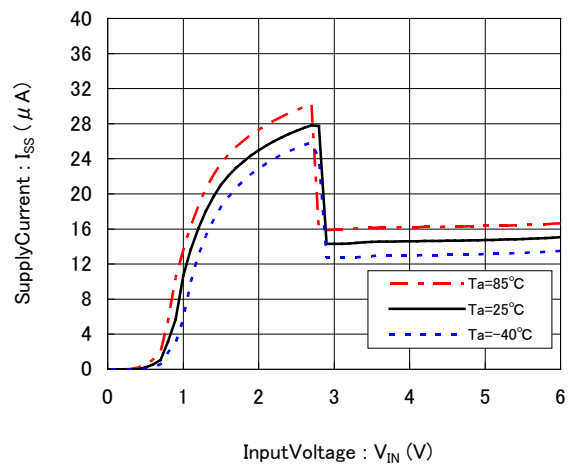

XC6503x501xx

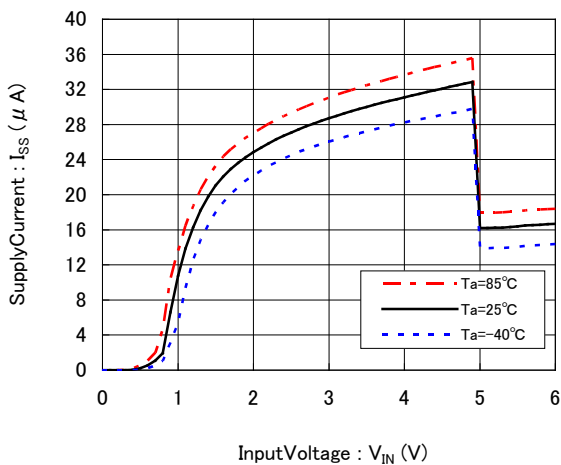

# ■ TYPICAL PERFORMANCE CHARACTERISTICS (Continued)

(5) Output Voltage v.s. Ambient Temperature

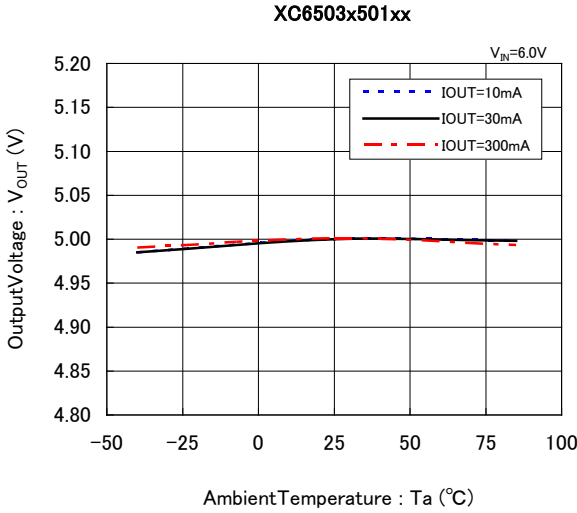
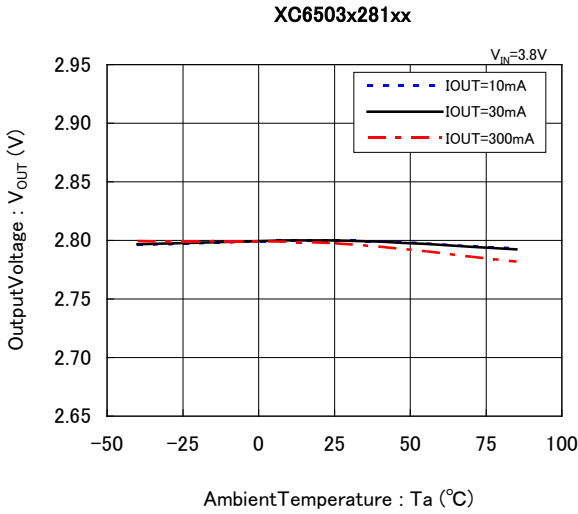
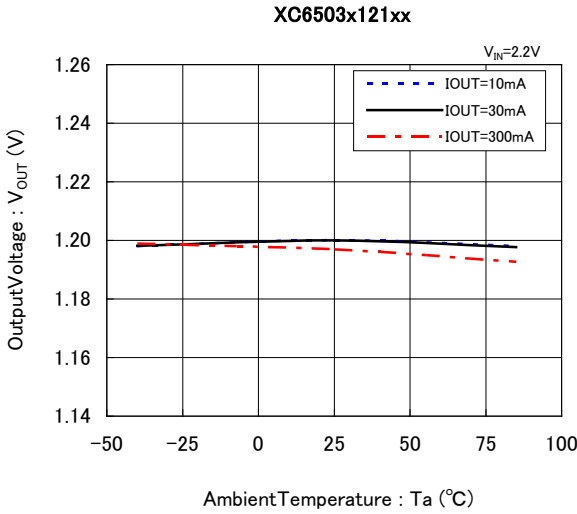

(6) Rising Response Time

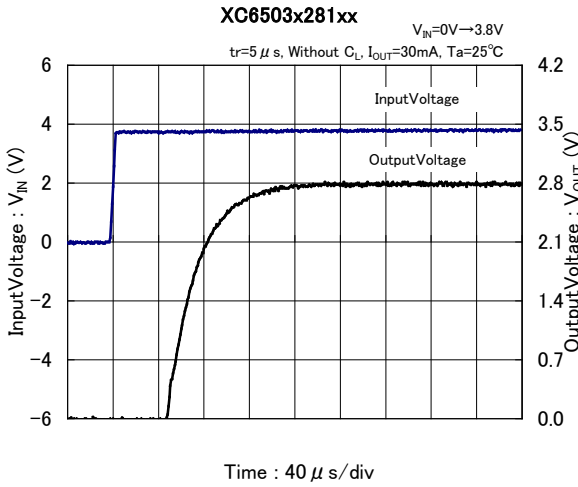
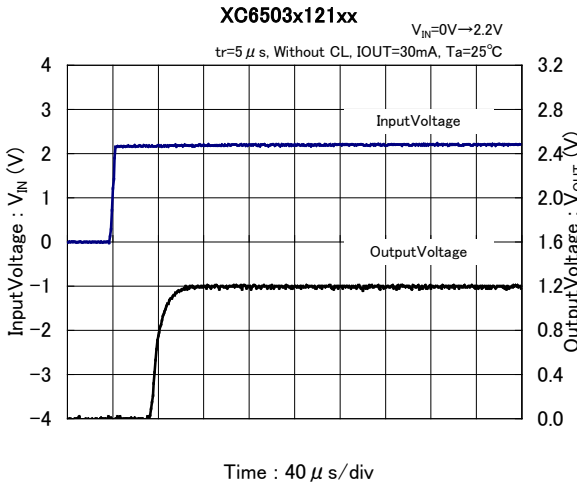

## TYPICAL PERFORMANCE CHARACTERISTICS (Continued)

### (6) Rising Response Time

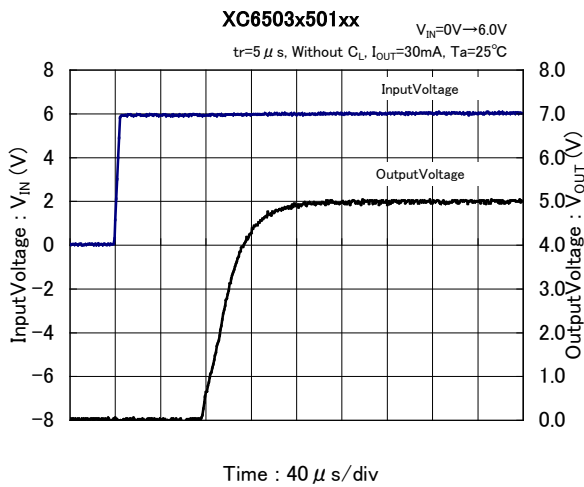

### (7) Rush Current

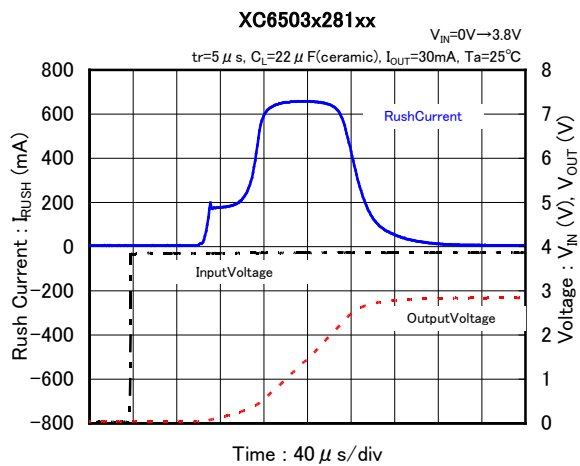
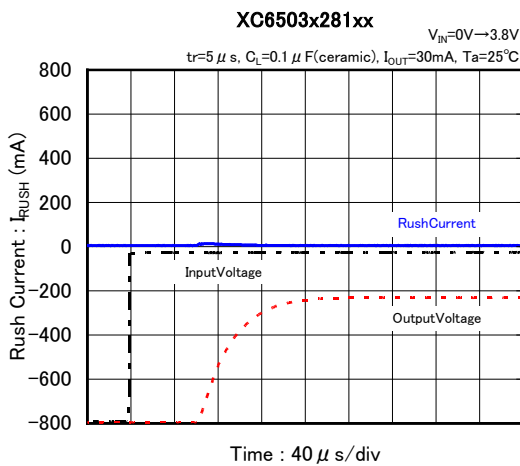

### (8) CE Rising Response Time

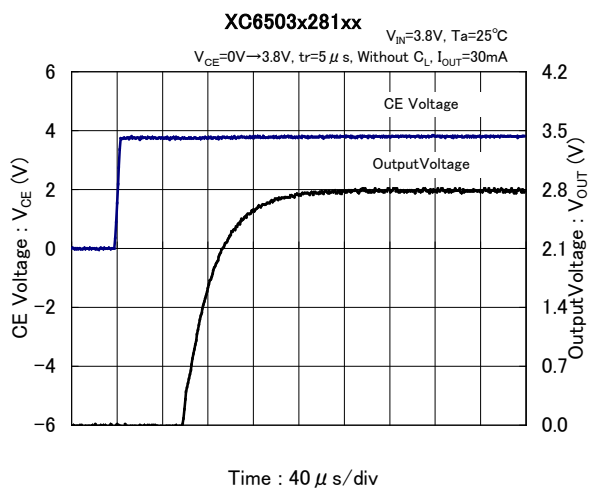
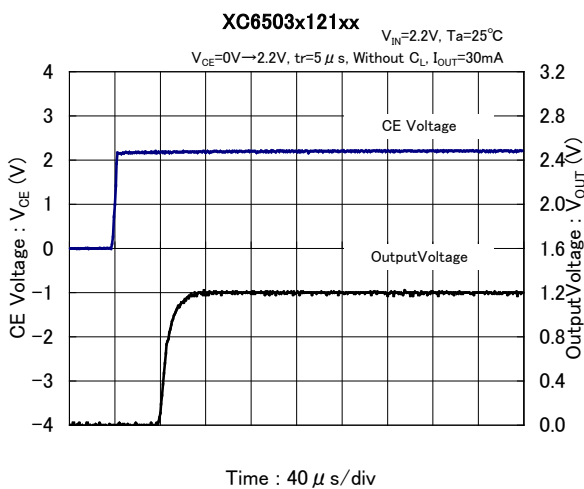



**■ TYPICAL PERFORMANCE CHARACTERISTICS (Continued)**

(8) CE Rising Respose Time

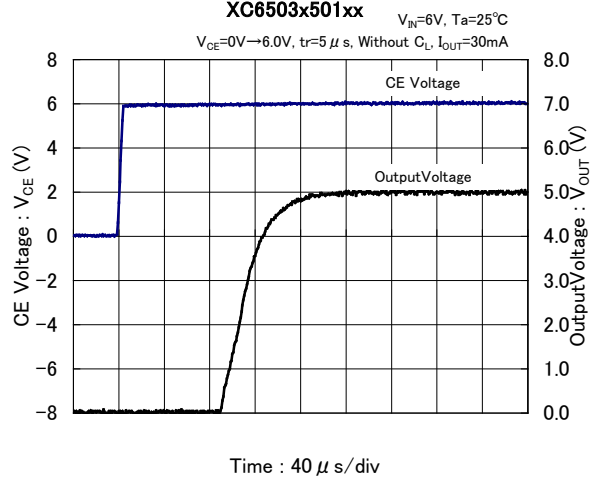

(9) Line transient response

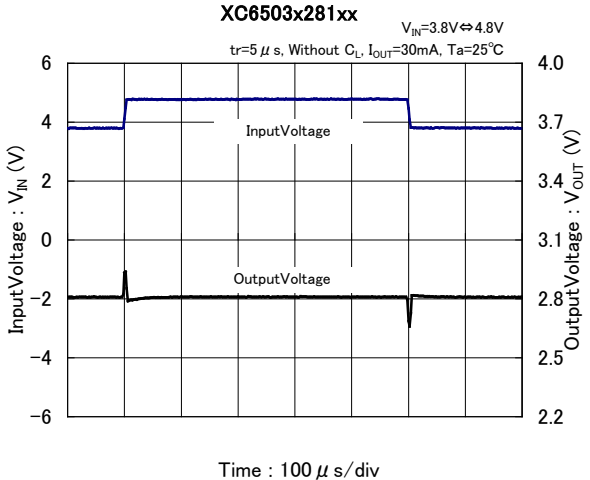
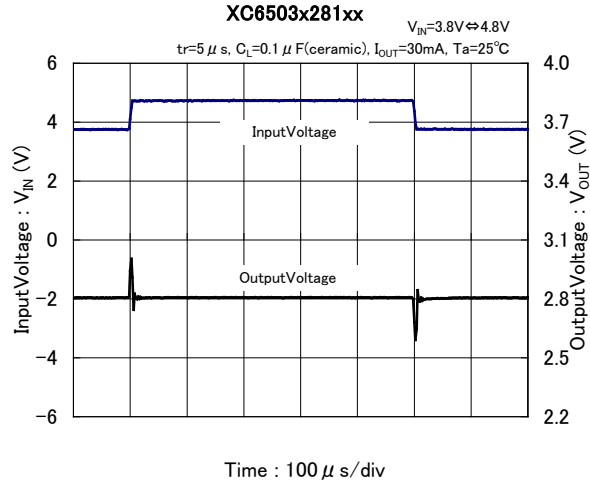
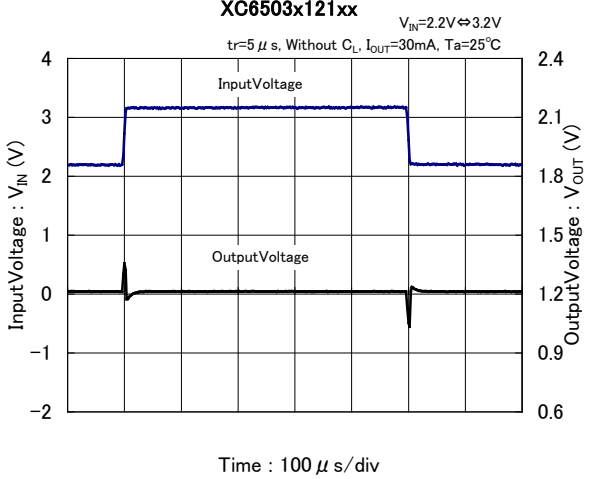
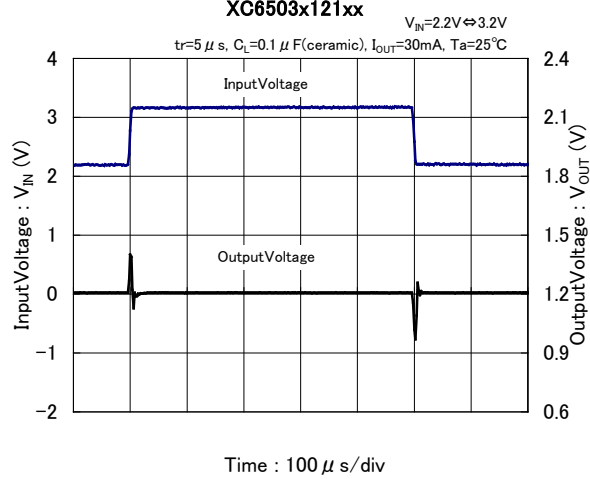

## TYPICAL PERFORMANCE CHARACTERISTICS (Continued)

### (9) Line transient response

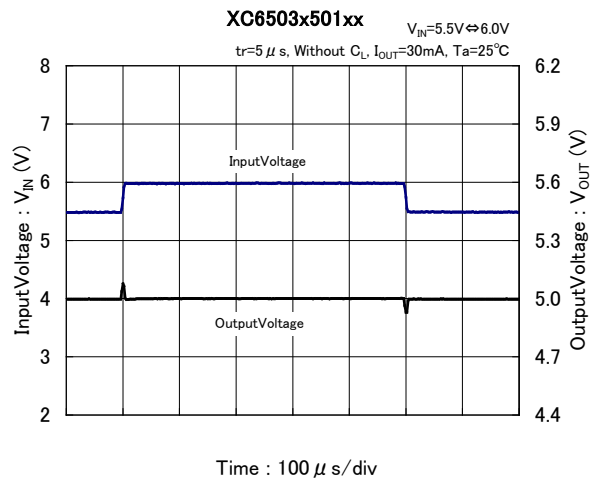
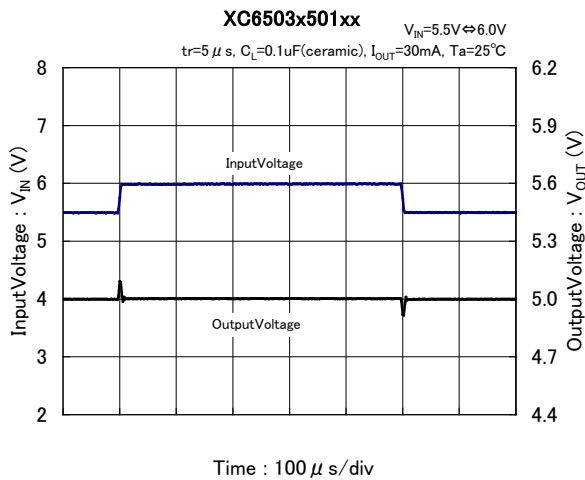

### (10) Load transient response

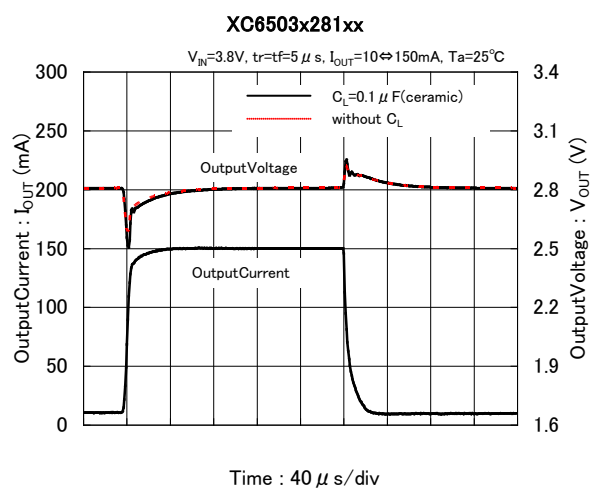
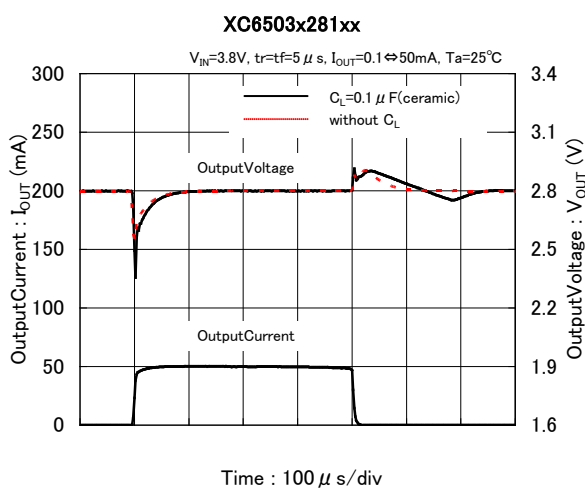
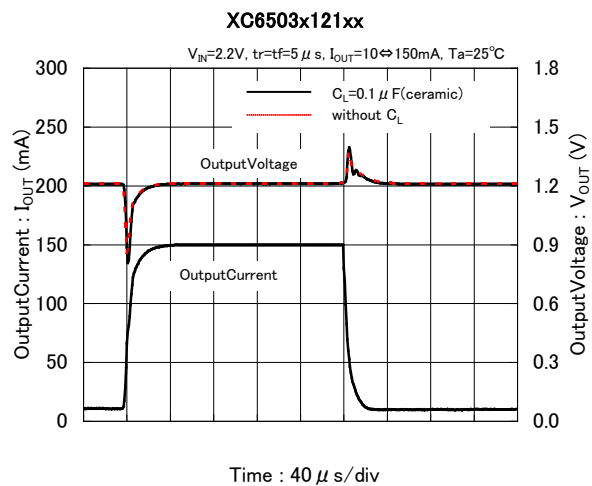
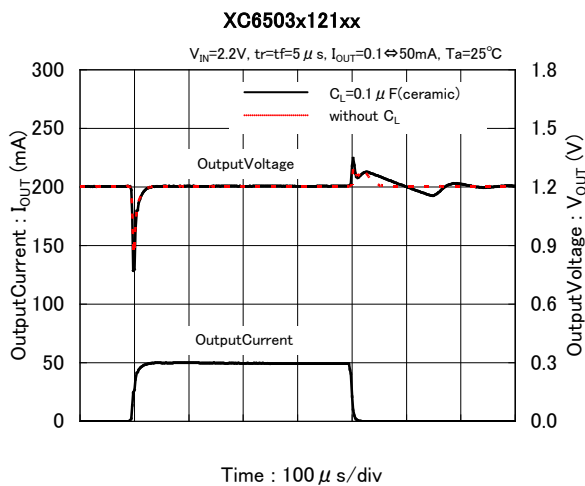

**TYPICAL PERFORMANCE CHARACTERISTICS (Continued)**

(10) Load transient response

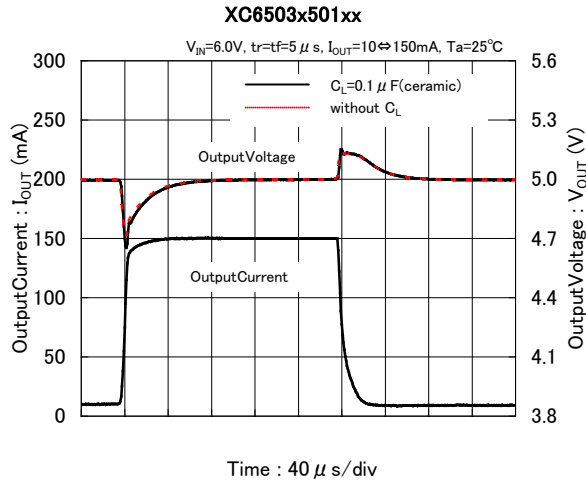
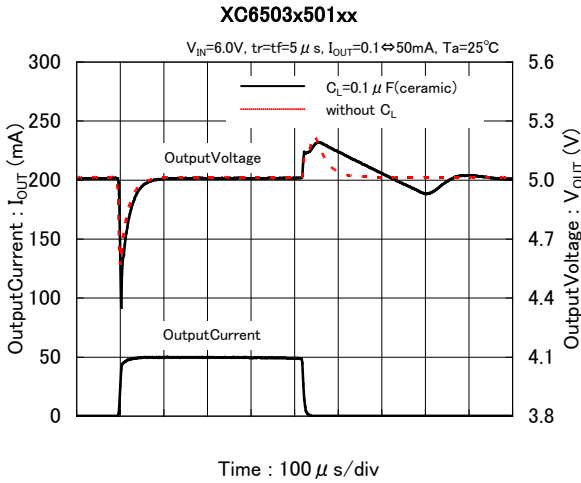

(11) Ripple Rejection Ratio

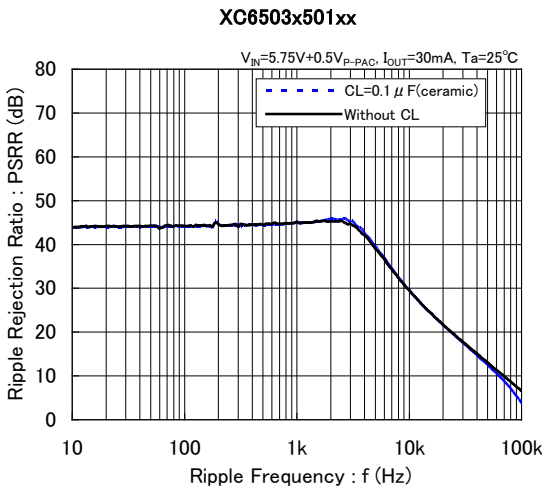
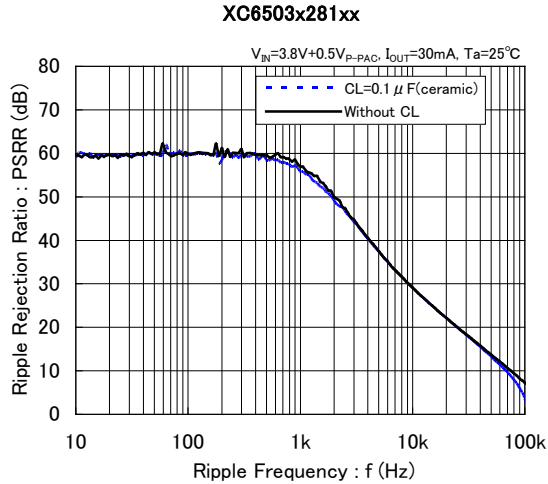
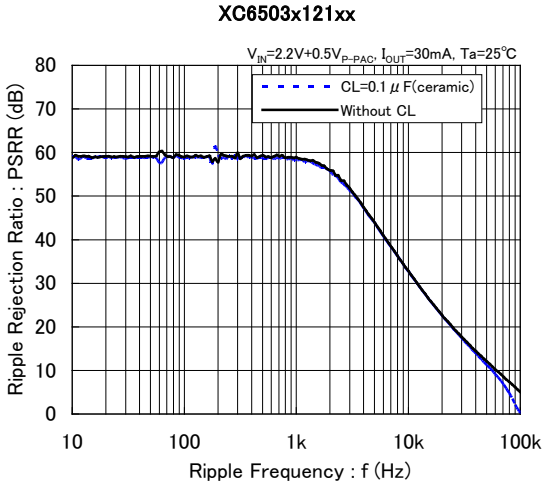

## ■ PACKAGING INFORMATION

For the latest package information go to, [www.torexsemi.com/technical-support/packages](http://www.torexsemi.com/technical-support/packages)

PACKAGE	OUTLIN / LAND PATTERN	THERMAL CHARACTERISTICS	
SOT-25	<a href="#">SOT-25 PKG</a>	Standard Board	<a href="#">SOT-25 Power Dissipation</a>
SOT-89	<a href="#">SOT-89 PKG</a>	Standard Board	<a href="#">SOT-89 Power Dissipation</a>
SOT-89-5	<a href="#">SOT-89-5 PKG</a>	Standard Board	<a href="#">SOT-89-5 Power Dissipation</a>
		JESD51-7 Board	
USP-4	<a href="#">USP-4 PKG</a>	Standard Board	<a href="#">USP-4 Power Dissipation</a>

## MARKING RULE

●SOT-25(Under dot), SOT-89, SOT-89-5, USP-4

① represents product series.

MARK	PRODUCT SERIES
1	XC6503*****-G

② represents type of regulators.

MARK				PRODUCT SERIES	PACKAGE
OUTPUT VOLTAGE 0.1V INCREMENTS		OUTPUT VOLTAGE 0.05V INCREMENTS			
VOLTAGE= 1.2~4.1V	VOLTAGE= 4.2~5.0V	VOLTAGE= 1.25~4.15V	VOLTAGE= 4.25~4.95V		
0	1	2	3	XC6503A*****-G	SOT-25/SOT-89-5/USP-4
				XC6503P*****-G	SOT-89
4	5	6	7	XC6503B*****-G	SOT-25/SOT-89-5/USP-4
8	9	A	B	XC6503C*****-G	SOT-25/SOT-89-5/USP-4
C	D	E	F	XC6503D*****-G	SOT-25/SOT-89-5/USP-4

③ represents output voltage.

MARK	OUTPUT VOLTAGE (V)				MARK	OUTPUT VOLTAGE (V)			
0	1.20	4.20	1.25	4.25	F	2.70	-	2.75	-
1	1.30	4.30	1.35	4.35	H	2.80	-	2.85	-
2	1.40	4.40	1.45	4.45	K	2.90	-	2.95	-
3	1.50	4.50	1.55	4.55	L	3.00	-	3.05	-
4	1.60	4.60	1.65	4.65	M	3.10	-	3.15	-
5	1.70	4.70	1.75	4.75	N	3.20	-	3.25	-
6	1.80	4.80	1.85	4.85	P	3.30	-	3.35	-
7	1.90	4.90	1.95	4.95	R	3.40	-	3.45	-
8	2.00	5.00	2.05	-	S	3.50	-	3.55	-
9	2.10	-	2.15	-	T	3.60	-	3.65	-
A	2.20	-	2.25	-	U	3.70	-	3.75	-
B	2.30	-	2.35	-	V	3.80	-	3.85	-
C	2.40	-	2.45	-	X	3.90	-	3.95	-
D	2.50	-	2.55	-	Y	4.00	-	4.05	-
E	2.60	-	2.65	-	Z	4.10	-	4.15	-

④⑤ represents production lot number

01 to 09, 0A to 0Z, 11 to 9Z, A1 to A9, AA to AZ, B1 to ZZ repeated. (G, I, J, O, Q, W excluded)

\* No character inversion used.

●SOT-25(Under dot)

●SOT-89-5

●USP-4

●SOT-89

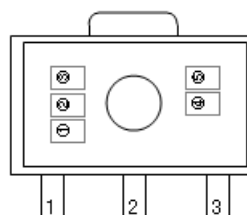
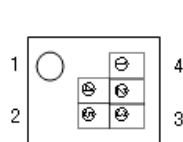
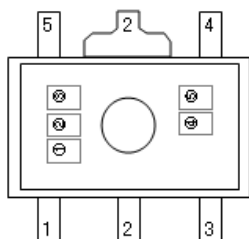
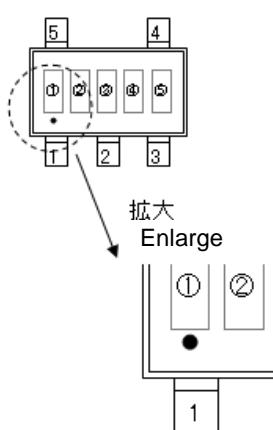

1. The product and product specifications contained herein are subject to change without notice to improve performance characteristics. Consult us, or our representatives before use, to confirm that the information in this datasheet is up to date.
2. The information in this datasheet is intended to illustrate the operation and characteristics of our products. We neither make warranties or representations with respect to the accuracy or completeness of the information contained in this datasheet nor grant any license to any intellectual property rights of ours or any third party concerning with the information in this datasheet.
3. Applicable export control laws and regulations should be complied and the procedures required by such laws and regulations should also be followed, when the product or any information contained in this datasheet is exported.
4. The product is neither intended nor warranted for use in equipment of systems which require extremely high levels of quality and/or reliability and/or a malfunction or failure which may cause loss of human life, bodily injury, serious property damage including but not limited to devices or equipment used in 1) nuclear facilities, 2) aerospace industry, 3) medical facilities, 4) automobile industry and other transportation industry and 5) safety devices and safety equipment to control combustions and explosions. Do not use the product for the above use unless agreed by us in writing in advance.
5. Although we make continuous efforts to improve the quality and reliability of our products; nevertheless Semiconductors are likely to fail with a certain probability. So in order to prevent personal injury and/or property damage resulting from such failure, customers are required to incorporate adequate safety measures in their designs, such as system fail safes, redundancy and fire prevention features.
6. Our products are not designed to be Radiation-resistant.
7. Please use the product listed in this datasheet within the specified ranges.
8. We assume no responsibility for damage or loss due to abnormal use.
9. All rights reserved. No part of this datasheet may be copied or reproduced unless agreed by Torex Semiconductor Ltd in writing in advance.

TOREX SEMICONDUCTOR LTD.

## X-ON Electronics

Largest Supplier of Electrical and Electronic Components

*Click to view similar products for [LDO Voltage Regulators](#) category:*

*Click to view products by [Torex Semiconductor](#) manufacturer:*

Other Similar products are found below :

[L79M05TL-E](#) [PT7M8202B12TA5EX](#) [TCR3DF185,LM\(CT](#) [TCR3DF24,LM\(CT](#) [TCR3DF285,LM\(CT](#) [TCR3DF31,LM\(CT](#)  
[TCR3DF45,LM\(CT](#) [MP2013GQ-33-Z](#) [059985X](#) [NCP4687DH15T1G](#) [701326R](#) [TCR2EN28,LF\(S](#) [NCV8170AXV250T2G](#)  
[TCR3DF27,LM\(CT](#) [TCR3DF19,LM\(CT](#) [TCR3DF125,LM\(CT](#) [TCR2EN18,LF\(S](#) [AP7315-25W5-7](#) [IFX30081LDVGRNXUMA1](#) [AP2111H-](#)  
[1.2TRG1](#) [ZLDO1117QK50TC](#) [AZ1117ID-ADJTRG1](#) [TCR3DG12,LF](#) [MIC5514-3.3YMT-T5](#) [MIC5512-1.2YMT-T5](#) [MIC5317-2.8YM5-T5](#)  
[SCD7912BTG](#) [NCP154MX180270TAG](#) [SCD33269T-5.0G](#) [NCV8703SN18T1G](#) [NCV8170BMX330TCG](#) [NCV8170AMX120TCG](#)  
[NCP706ABMX300TAG](#) [NCP153MX330180TCG](#) [NCP114BMX075TCG](#) [MC33269T-3.5G](#) [CAT6243-ADJCMT5T](#) [TCR3DG33,LF](#)  
[BD3021HFP-MTR](#) [TCR4DG35,LF](#) [LT1117CST-3.3](#) [TAR5S15U\(TE85L,F\)](#) [TAR5S18U\(TE85L,F\)](#) [TCR3UG19A,LF](#) [TCR4DG105,LF](#)  
[NCV8170AMX360TCG](#) [MIC94310-NYMT-T5](#) [NCV4266-2CST33T3G](#) [TLE4268GSXUMA2](#) [NCV8186BMN175TAG](#)