

XC6505 Series

Low Power Consumption, High Speed 200mA LDO Regulator - 10.5V Input

■ GENERAL DESCRIPTION

Even the XC6505 series is a low power consumption such as $5.5 \mu\text{A}$, the IC is a high speed CMOS LDO regulator that features high accurate, low noise, high ripple rejection, and low dropout. The series consists of a voltage reference, an error amplifier, a driver transistor, a current limiter, a phase compensation circuit and a thermal shutdown circuit.

The CE function enables the circuit to be in stand-by mode by inputting low level signal. In the stand-by mode, the series enables the electric charge at the output capacitor C_L to be discharged via the internal switch, and as a result the V_{OUT} pin quickly returns to the V_{SS} level.

The over current protection circuit and the thermal shutdown circuit are built-in. These two protection circuits will operate when the output current reaches current limit level or the junction temperature reaches temperature detection level.

■ APPLICATIONS

- Car navigation systems
- Car audios
- Digital still cameras / Camcorders

■ FEATURES

Maximum Output Current	:	200mA
Input Voltage	:	1.7V ~ 10.5V
Output Voltage	:	1.5V ~ 8.0V (0.1V increments)
Accuracy	:	$\pm 1.0\%$ (2.0V~8.0V) $\pm 20\text{mV}$ (1.5V~1.9V)
Temperature Stability	:	$\pm 30\text{ppm}/^\circ\text{C}$
Dropout Voltage	:	190mV @ $V_{\text{OUT}}=3.3\text{V}$, $I_{\text{OUT}}=100\text{mA}$
Low Power Consumption	:	5.5 μA (TYP.)
Chip Enable(CE)	:	Active High 0.1 μA (Stand-by)
High Ripple Rejection	:	60dB@1kHz
Protection	:	Current Limiter (300mA, TYP.) Short circuit protection (110mA, TYP.) Thermal Shutdown
Operating Ambient Temperature	:	-40~+105 $^\circ\text{C}$
Packages	:	USP-6C, SOT-25, SOT-89-5
Environmentally Friendly	:	EU RoHS Compliant, Pb Free

■ TYPICAL APPLICATION CIRCUIT ■ TYPICAL PERFORMANCE CHARACTERISTICS

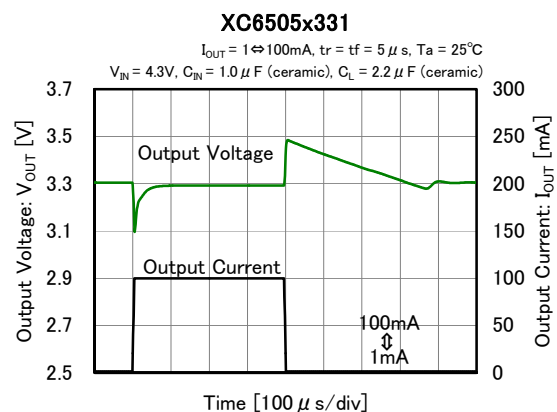
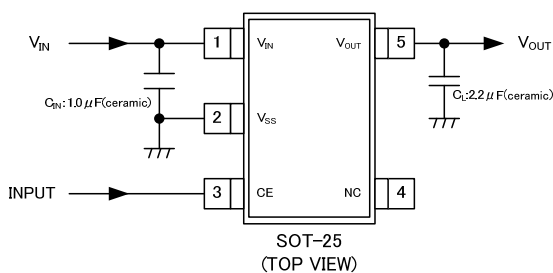

PIN CONFIGURATION

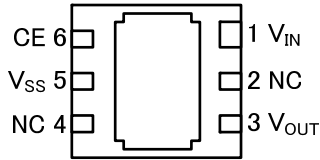

USP-6C
(BOTTOM VIEW)

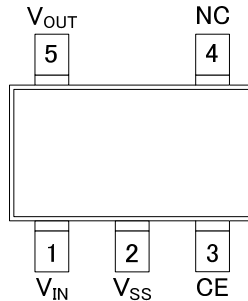

SOT-25
(TOP VIEW)

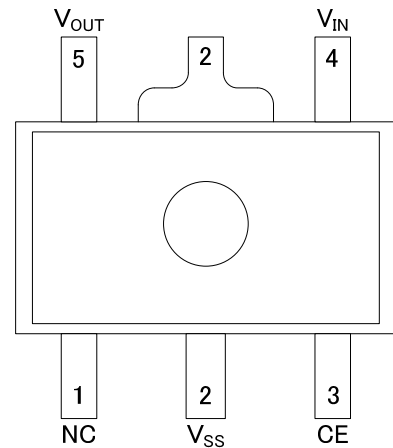

SOT-89-5
(TOP VIEW)

*The dissipation pad for the USP-6C package should be solder-plated in recommended mount pattern and metal masking so as to enhance mounting strength and heat release.

If the pad needs to be connected to other pins, it should be connected to the V_{SS} (No. 5) pin.

PIN ASSIGNMENT

PIN NUMBER			PIN NAME	FUNCTIONS
USP-6C	SOT-25	SOT-89-5		
1	1	4	V_{IN}	Power Input
3	5	5	V_{OUT}	Output
5	2	2	V_{SS}	Ground
6	3	3	CE	ON/OFF Control
2,4	4	1	NC	No connection

PRODUCT CLASSIFICATION

Ordering Information

XC6505①②③④⑤⑥-⑦^(*)

DESIGNATOR	ITEM	SYMBOL	DESCRIPTION
①	Type of Regulators	A	without CE Pull-down, without C_L Discharge
		B (The Recommended Type)	without CE Pull-down, with C_L Discharge
②③	Output Voltage	15~80	e.g. 2.8V → ②=2, ③=8
④	Output Accuracy	1	$\pm 1.0\%$ (2.0V~8.0V) $\pm 20\text{mV}$ (1.5V~1.9V)
⑤⑥-⑦	Packages (Order Unit)	ER-G	USP-6C (3,000/Reel)
		MR-G	SOT-25 (3,000/Reel)
		PR-G	SOT-89-5 (1,000/Reel)

(*) The "-G" suffix indicates that the products are Halogen and Antimony free as well as being fully EU RoHS compliant.

(*) With CE Pull-down, please contact your local Torex sales office or representative.

■ BLOCK DIAGRAMS

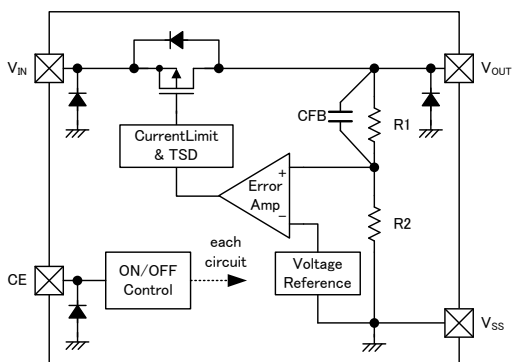

XC6505A Series

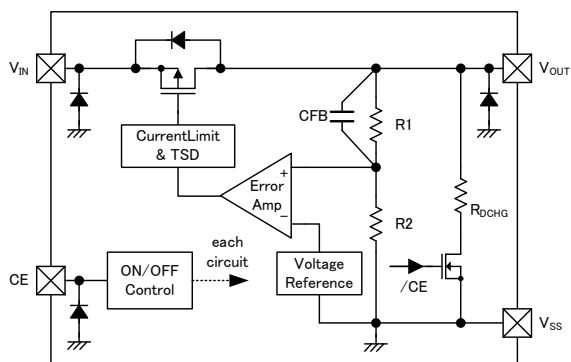

XC6505B Series

* Diodes inside the circuits are ESD protection diodes and parasitic diodes.

■ ABSOLUTE MAXIMUM RATINGS

Ta=25°C

PARAMETER	SYMBOL	RATINGS	UNITS
Input Voltage	V _{IN}	V _{SS} -0.3~+12.0	V
Output Current	I _{OUT}	450 (*1)	mA
Output Voltage	V _{OUT}	V _{SS} -0.3~V _{IN} +0.3	V
CE Input Voltage	V _{CE}	V _{SS} -0.3~+12.0	V
Power Dissipation	USP-6C	Pd	120
	SOT-25		250
	SOT-89-5		500
Power Dissipation (*2) (PCB mounted)	USP-6C	Pd	1000
	SOT-25		600
	SOT-89-5		1300
Operating Temperature Range	Topr	-40~+105	°C
Storage Temperature Range	Tstg	-55~+125	°C

(*1) Please use within the range of Pd > (V_{IN}-V_{OUT}) × I_{OUT}

(*2) This is a reference data taken by using the test board. Please refer to page 20 for details.

ELECTRICAL CHARACTERISTICS

●XC6505A/B Series

Ta=25°C

PARAMETER	SYMBOL	CONDITIONS	MIN.	TYP.	MAX.	UNIT	CIRCUIT
Output Voltage	$V_{OUT(E)}$ ^(*2)	$V_{OUT(T)}^{(*3)} < 2.0V$ $V_{CE}=V_{IN}, I_{OUT}=10mA$	-0.02 ^(*4)	$V_{OUT(T)}$	+0.02 ^(*4)	V	①
		$V_{OUT(T)} \geq 2.0V$ $V_{CE}=V_{IN}, I_{OUT}=10mA$	$\times 0.99^{(*4)}$		$\times 1.01^{(*4)}$		
Maximum Output Current	I_{OUTMAX}	$V_{OUT(T)} \leq 2.0V$ $V_{CE}=V_{IN}=V_{OUT(T)} + 1.5V$	200	-	-	mA	①
		$V_{OUT(T)} > 2.0V$ $V_{CE}=V_{IN}=V_{OUT(T)} + 1.0V$					
Load Regulation	ΔV_{OUT}	$V_{CE}=V_{IN}, 0.1mA \leq I_{OUT} \leq 100mA$	-	20	40	mV	①
Dropout Voltage ^(*5)	Vdif	$V_{CE}=V_{IN}, I_{OUT}=100mA$	Refer to VOLTAGE CHART E-1			mV	①
Supply Current	I_{DD}	$V_{OUT(T)} \leq 5.0V$ $V_{CE}=V_{IN}, I_{OUT}=0mA$	-	5.5	8.0	μA	②
		$V_{OUT(T)} > 5.0V$ $V_{CE}=V_{IN}, I_{OUT}=0mA$	-	6.0	10.0		
Stand-by Current	I_{STB}	$V_{IN}=10.5V, V_{CE}=V_{SS}$	-	0.01	0.1	μA	②
Line Regulation	$\frac{\Delta V_{OUT}}{(\Delta V_{IN} \cdot V_{OUT})}$	$V_{OUT(T)}+0.5V \leq V_{IN} \leq 10.5V, V_{CE}=V_{IN}, I_{OUT}=30mA$	-	0.1	0.2	%/V	①
Input Voltage	V_{IN}		1.7	-	10.5	V	①
Output Voltage Temperature Characteristics	$\frac{\Delta V_{OUT}}{(\Delta T_{opr} \cdot V_{OUT})}$	$V_{CE}=V_{IN}, I_{OUT}=30mA$ $-40^{\circ}C \leq T_{opr} \leq 105^{\circ}C$	-	± 30	-	ppm/ °C	①
Ripple Rejection Rate	PSRR	$V_{IN}=\{V_{OUT(T)}+1.0\}V_{DC}+0.5V_{p-pAC}$ $V_{CE}=V_{IN}, I_{OUT}=30mA, f=1kHz$	Refer to VOLTAGE CHART E-2			dB	③
Limit Current	I_{LIM}	$V_{OUT(T)} \leq 2.0V$ $V_{CE}=V_{IN}=V_{OUT(T)} + 1.5V, V_{OUT}=V_{OUT(T)} \times 0.95$	210	300	-	mA	①
		$V_{OUT(T)} > 2.0V$ $V_{CE}=V_{IN}=V_{OUT(T)} + 1.0V, V_{OUT}=V_{OUT(T)} \times 0.95$					
Short Current	I_{SHORT}	$V_{CE}=V_{IN}, \text{Short } V_{OUT} \text{ to } V_{SS} \text{ level}$	-	110	-	mA	①
CE High Level Voltage	V_{CEH}		1.2	-	V_{IN}	V	①
CE Low Level Voltage	V_{CEL}		V_{SS}	-	0.45	V	①
CE High Level Current	I_{CEH}	$V_{IN}=V_{CE}=10.5V$	-0.1	-	0.1	μA	①
CE Low Level Current	I_{CEL}	$V_{CE}=V_{SS}$	-0.1	-	0.1	μA	①
CL Auto-Discharge Resistance ^(*8)	R_{DCHG}	$V_{IN}=10.5V, V_{CE}=V_{SS}, V_{OUT}=5.0V$	300	400	500	Ω	①
Thermal Shutdown Detect Temperature	T_{TSD}	Junction Temperature	-	150	-	°C	-
Thermal Shutdown Release Temperature	T_{TSR}	Junction Temperature	-	125	-	°C	-
Thermal Shutdown Hysteresis Width	T_{HYS}	$T_{TSD} - T_{TSR}$	-	25	-	°C	-

NOTE:

(* 1) Unless otherwise stated, input voltage is $V_{IN}=V_{OUT(T)}^{(*3)} + 1.0V$.

(* 2) $V_{OUT(E)}$ is defined as output voltages when an amply stabilized $V_{OUT(T)}+1.0V$ is supplied to the V_{IN} pin while maintaining a certain I_{OUT} .

(* 3) $V_{OUT(T)}$ is nominal output voltage

(* 4) For the specified value of the effective output voltage $V_{OUT(E)}$ of each nominal output voltage, refer to VOLTAGE CHART E-0.

(* 5) $V_{dif} = V_{IN1}^{(*6)} - V_{OUT1}^{(*7)}$

(* 6) V_{IN1} is the input voltage when V_{OUT1} appears at the V_{OUT} pin while input voltage is gradually decreased.

(* 7) V_{OUT1} equals 98% of the output voltage when amply stabilized $V_{OUT(T)}+1.0V$ are supplied to the V_{IN} pin.

(* 8) R_{DCHG} is effective for the XC6505B Series only. The XC6505A Series discharges only through the resistance $R1 + R2$ in the block diagram.

■ ELECTRICAL CHARACTERISTICS (Continued)

NOMINAL VOLTAGE (V)	E-0		E-1		E-2	NOMINAL VOLTAGE (V)	E-0		E-1		E-2
	OUTPUT VOLTAGE (V)		DROPOUT VOLTAGE (mV)		Ripple Rejection Rate (dB)		OUTPUT VOLTAGE (V)		DROPOUT VOLTAGE (mV)		Ripple Rejection Rate (dB)
V _{OUT(T)}	V _{OUT(E)}		V _{dif}		PSRR	V _{OUT(T)}	V _{OUT(E)}		V _{dif}		PSRR
	MIN.	MAX.	TYP.	MAX.	TYP.		MIN.	MAX.	TYP.	MAX.	TYP.
1.5	1.480	1.520	430	540	60	5.0	4.950	5.050	140	185	50
1.6	1.580	1.620	400	490		5.1	5.049	5.151	140	185	
1.7	1.680	1.720	370	450		5.2	5.148	5.252	140	185	
1.8	1.780	1.820	350	420		5.3	5.247	5.353	140	185	
1.9	1.880	1.920	330	400		5.4	5.346	5.454	140	185	
2.0	1.980	2.020	300	370		5.5	5.445	5.555	140	185	
2.1	2.079	2.121	280	350		5.6	5.544	5.656	140	185	
2.2	2.178	2.222	260	330		5.7	5.643	5.757	140	185	
2.3	2.277	2.323	240	310		5.8	5.742	5.858	130	180	
2.4	2.376	2.424	230	290		5.9	5.841	5.959	130	180	
2.5	2.475	2.525	220	280		6.0	5.940	6.060	130	180	
2.6	2.574	2.626	210	270		6.1	6.039	6.161	130	180	
2.7	2.673	2.727	200	260		6.2	6.138	6.262	130	180	
2.8	2.772	2.828	200	260		6.3	6.237	6.363	130	180	
2.9	2.871	2.929	200	250		6.4	6.336	6.464	130	180	
3.0	2.970	3.030	200	250		6.5	6.435	6.565	120	175	
3.1	3.069	3.131	190	240		6.6	6.534	6.666	120	175	
3.2	3.168	3.232	190	240		6.7	6.633	6.767	120	175	
3.3	3.267	3.333	190	240		6.8	6.732	6.868	120	175	
3.4	3.366	3.434	180	230		6.9	6.831	6.969	120	175	
3.5	3.465	3.535	180	230	7.0	6.930	7.070	120	175		
3.6	3.564	3.636	170	220	7.1	7.029	7.171	120	175		
3.7	3.663	3.737	170	220	7.2	7.128	7.272	110	170		
3.8	3.762	3.838	170	210	7.3	7.227	7.373	110	170		
3.9	3.861	3.939	170	210	7.4	7.326	7.474	110	170		
4.0	3.960	4.040	170	210	7.5	7.425	7.575	110	170		
4.1	4.059	4.141	170	210	7.6	7.524	7.676	110	170		
4.2	4.158	4.242	160	200	7.7	7.623	7.777	110	170		
4.3	4.257	4.343	160	200	7.8	7.722	7.878	110	170		
4.4	4.356	4.444	160	200	7.9	7.821	7.979	110	170		
4.5	4.455	4.545	160	200	8.0	7.920	8.080	110	170		
4.6	4.554	4.646	150	190						45	
4.7	4.653	4.747	150	190							
4.8	4.752	4.848	150	190							
4.9	4.851	4.949	150	190							

OPERATIONAL EXPLANATION

The voltage divided by resistors R1 & R2 is compared with the internal reference voltage by the error amplifier. The P-channel MOSFET which is connected to the V_{OUT} pin is then driven by the subsequent output signal. The output voltage at the V_{OUT} pin is controlled and stabilized by a system of negative feedback. The current limit circuit and short protection circuit operate in relation to the level of output current and heat dissipation. Further, the IC's internal circuitry can be shutdown via the CE pin signal.

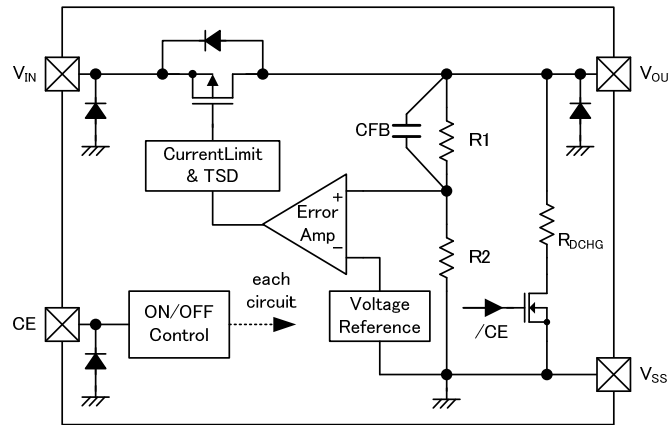

XC6505B Series

<CE Pin>

The XC6505 Series is able to shut down the regulator circuit using the CE pin signal. In the shutdown state, the V_{OUT} pin is pulled down by R1 and R2 to the V_{SS} level. In the XC6505B Series, the C_L discharge resistance is connected in parallel with R1 and R2 when power is supplied to V_{IN}, shortening the time until the V_{SS} level is reached. Operation is unstable when the CE pin is open, and thus the V_{IN} voltage or the V_{SS} voltage should be input into the CE pin. Although the logic is fixed and operation is normal as long the voltage satisfies the CE pin voltage specification, inputting an intermediate voltage may cause the supply current to increase due to the flowthrough current in the IC internal circuit.

<C_L Auto-Discharge Function>

The XC6505B type is capable of high-speed discharge of the charge that collects on the output capacitor (C_L below). This is accomplished by the N-channel MOSFET connected between the V_{OUT} and V_{SS} pins in the block diagram, and takes place when the L-level signal (IC internal circuit shutdown signal) of the CE pin is input. The C_L discharge resistance is set to 400 Ω (when V_{IN} = 10.5 V, V_{OUT} = 5.0 V typical). The C_L discharge time is determined by this C_L discharge resistance and C_L. Letting the time constant of the C_L discharge resistance R_{DCHG} and C_L be τ (τ = C × R), the output voltage after discharge by the N-channel MOSFET can be obtained from the CR discharge equation below.

$$V = V_{OUT(E)} \times e^{-t/\tau} \quad \text{or} \quad t = \tau \ln(V_{OUT(E)}/V)$$

V: Output voltage after discharge

V_{OUT(E)}: Output voltage

t: Discharge time

τ: C_L auto-discharge resistance R_{DCHG} × C_L Output capacitor value C_L

<Current Limiter, Short-Circuit Protection>

The XC6505 series' fold-back circuit operates as an output current limiter and a short protection circuit for the output pin. When the load current reaches the current limit level, the fixed current limiter circuit operates and output voltage drops. When the output pin is short-circuited to the V_{SS} pin, the current falls and reaches about 110mA.

<Thermal Shutdown>

The XC6505 Series has an internal thermal shutdown (TSD) circuit for protection against overheating. When the junction temperature reaches the detection temperature, the driver transistor is forcibly turned off. When the junction temperature falls to the release temperature with the driver transistor still in the off state, the driver transistor turns on (automatic recovery) and restarts regulator operation.

■ OPERATIONAL EXPLANATION

<Input/output capacitor>

The XC6505 Series uses an output capacitor (C_L) for phase compensation. For this reason, if a small capacitor or low withstand-voltage capacitor is used for C_L , DC bias dependence causes a smaller capacitance value, and phase shifting that results in unstable operation may occur. Exercise caution when selecting the capacitor. Recommended capacitances for the XC6505 Series are shown below.

For the input capacitor (C_{IN}), select a capacitance of 1.0 μ F or higher to stabilize the input power.

Table1 : Recommended C_L capacitances

Manufacturer	Product Number	Capacity [μ F]	Size Unit		Size L x W [mm]	Withstand Voltage [V]	Temperature Range [$^{\circ}$ C]
			JIS	EIA			
TDK	C2012X7R1C225K	2.2	2012	0805	2.0 x 1.25	16	-55 ~ 125
MURATA	GRM21BR71C225K	2.2	2012	0805	2.0 x 1.25	16	-55 ~ 125
TAIYO YUDEN	EMK212B7225K	2.2	2012	0805	2.0 x 1.25	16	-55 ~ 125

■ NOTES ON USE

1. For temporary, transitional voltage drop or voltage rising phenomenon, the IC is liable to malfunction should the ratings be exceeded.
2. Where wiring impedance is high, operations may become unstable due to noise and/or phase lag depending on output current. Please wire the input capacitor (C_{IN}) and the output capacitor (C_L) as close to the IC as possible.
3. If the input voltage fluctuates by 1.5 V or more and is at a slope of 0.1 V/ μ s or more, output voltage undershoot may become more pronounced. In this case, use a larger input capacitor (C_{IN}) or otherwise adjust so that the through rate is less than 0.1 V/ μ s.
4. If a small capacitor is used for the output capacitor (C_L below), capacitance loss due to DC bias dependence will become more pronounced. This will increase the tendency for phase shifting to occur, resulting in unstable operation. Test thoroughly before using.
For guidelines for the C_L capacitance, check the XC6505 recommended capacitance characteristics (refer to Operational Explanation, Input/Output Capacitors).
5. Torex places an importance on improving our products and its reliability.
However, by any possibility, we would request user fail-safe design and post-aging treatment on system or equipment.

TEST CIRCUITS

● Circuit ①

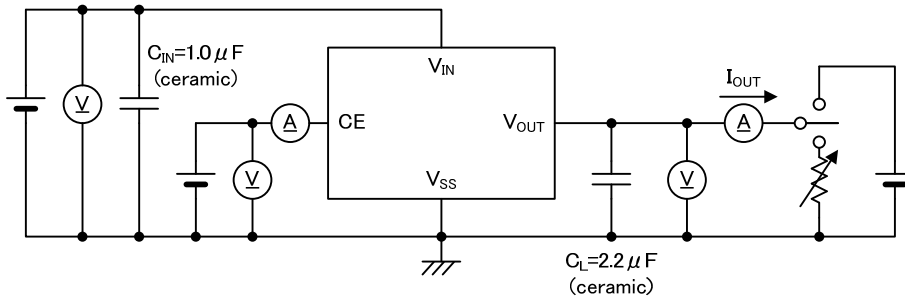

● Circuit ②

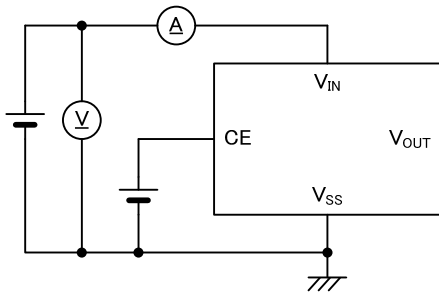

● Circuit ③

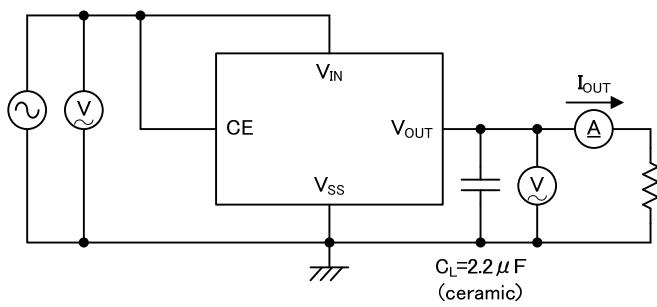

TYPICAL PERFORMANCE CHARACTERISTICS

*CE Voltage condition: Unless otherwise stated, $V_{CE}=V_{IN}$

(1) Output Voltage vs. Output Current

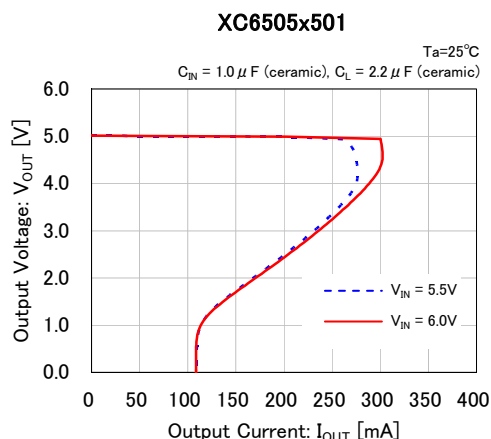
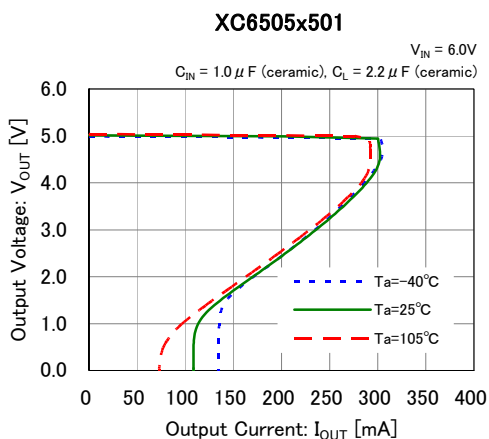
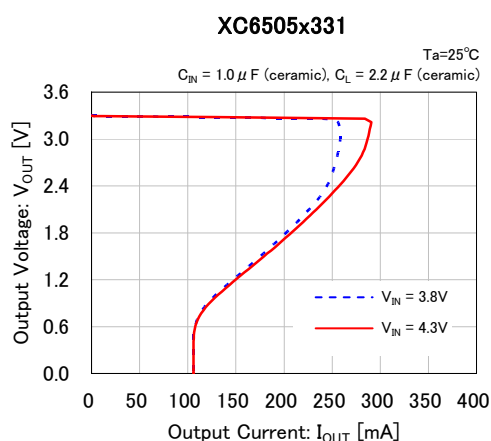
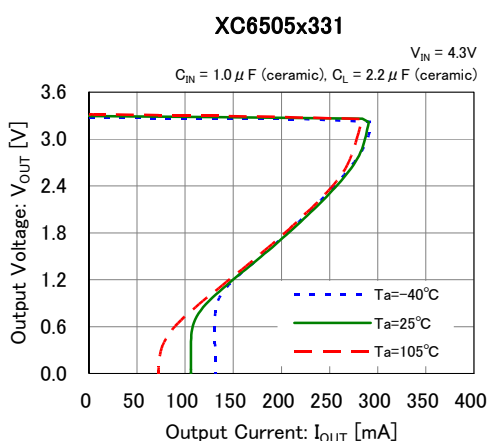
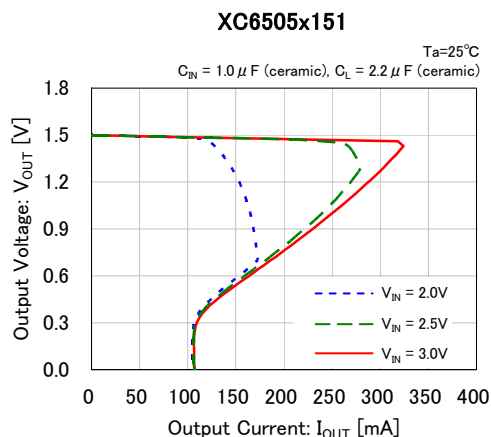
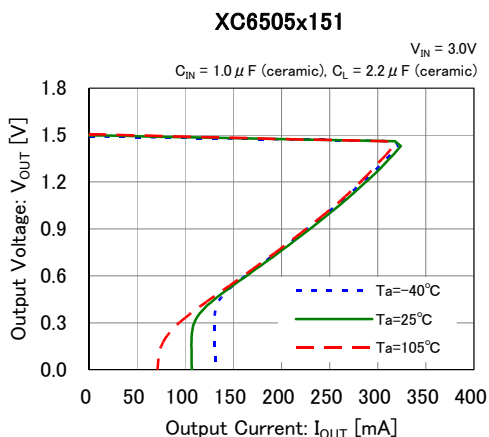

TYPICAL PERFORMANCE CHARACTERISTICS (Continued)

(1) Output Voltage vs. Output Current

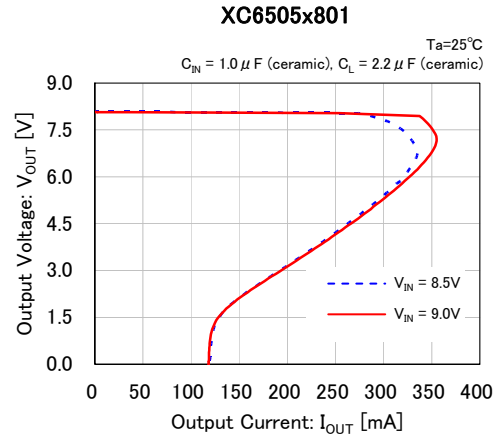
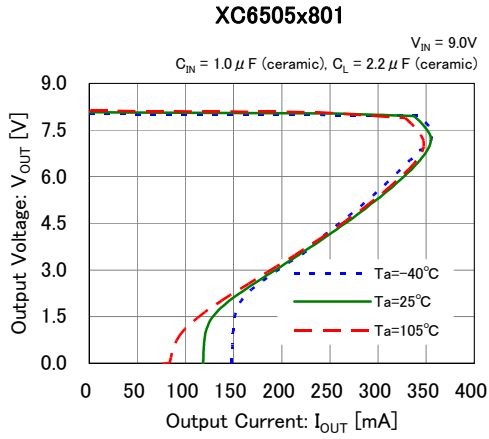

(2) Output Voltage vs. Input Voltage

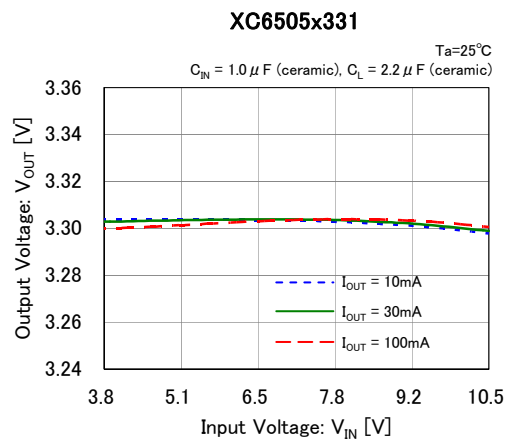
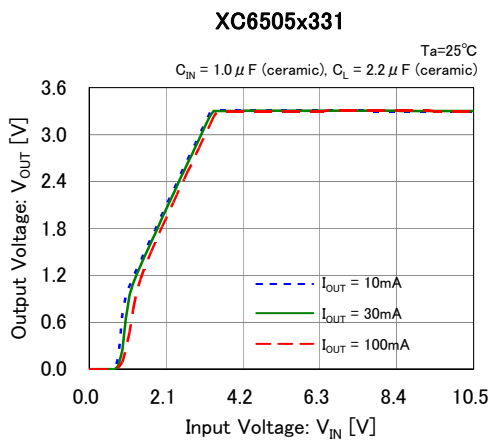
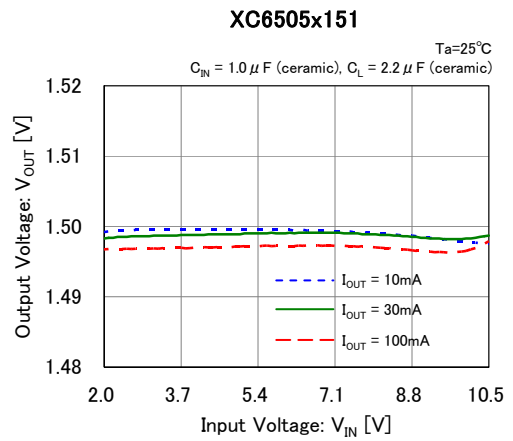
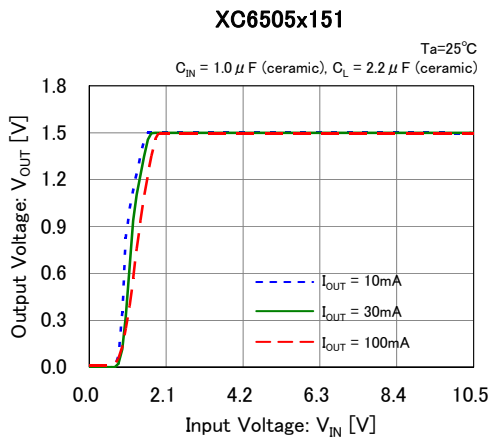

■ TYPICAL PERFORMANCE CHARACTERISTICS (Continued)

(2) Output Voltage vs. Input Voltage

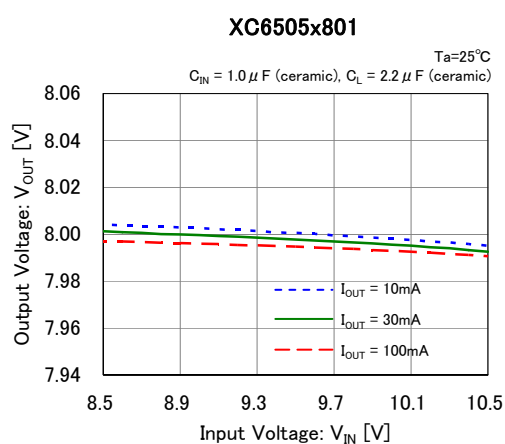
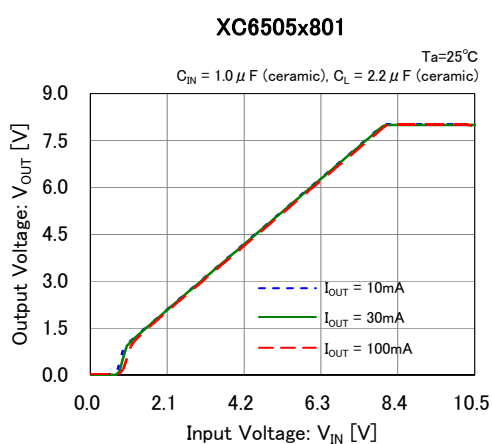
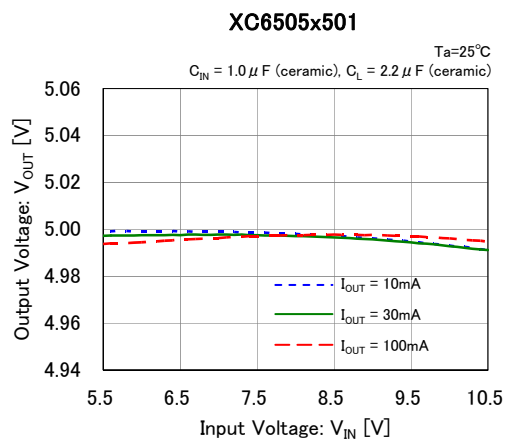
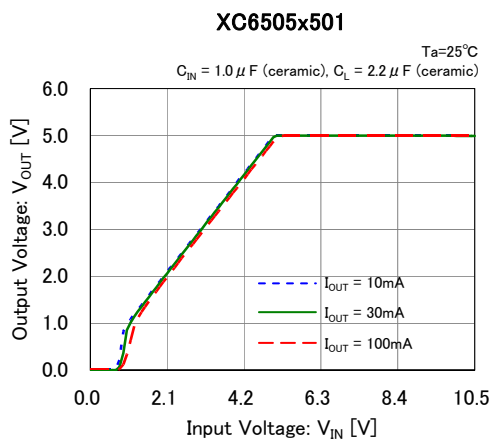

(3) Dropout Voltage vs. Output Current

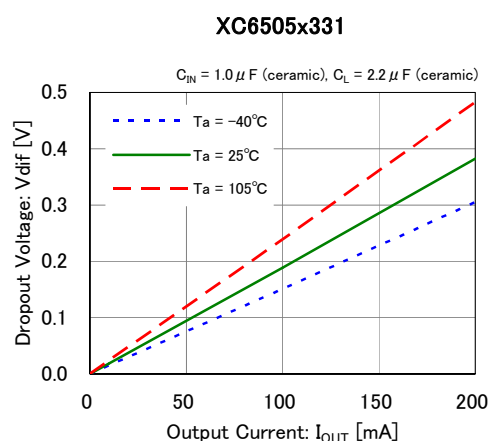
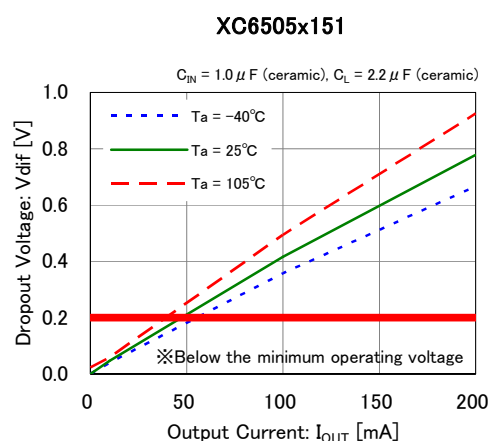

TYPICAL PERFORMANCE CHARACTERISTICS (Continued)

(3) Dropout Voltage vs. Output Current

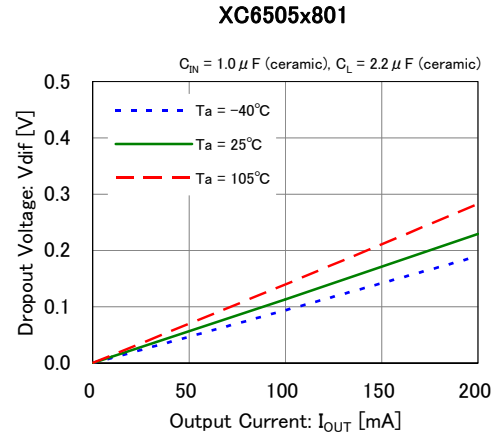
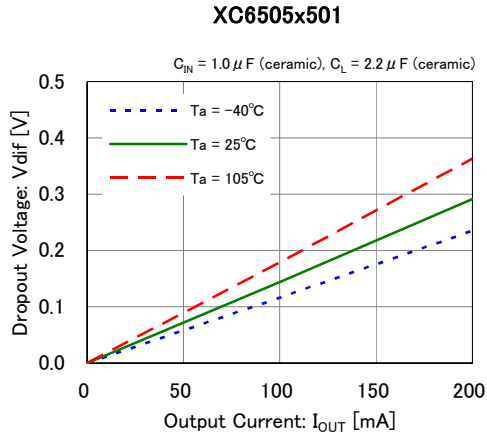

(4) Supply Current vs. Input Voltage

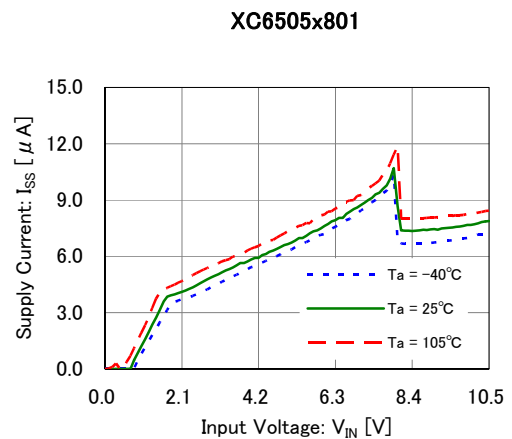
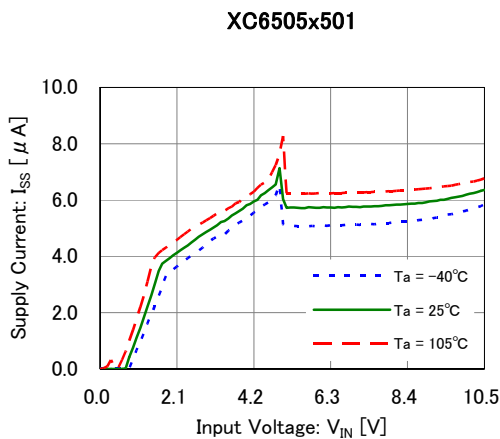
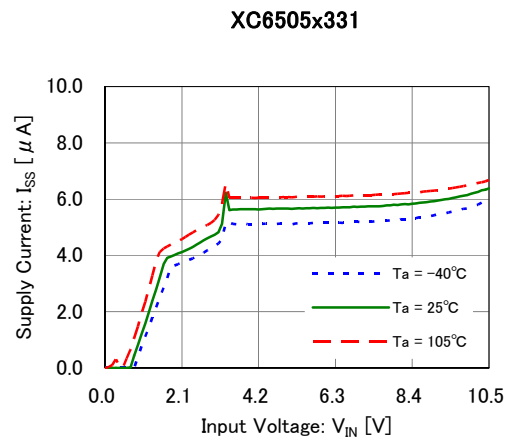
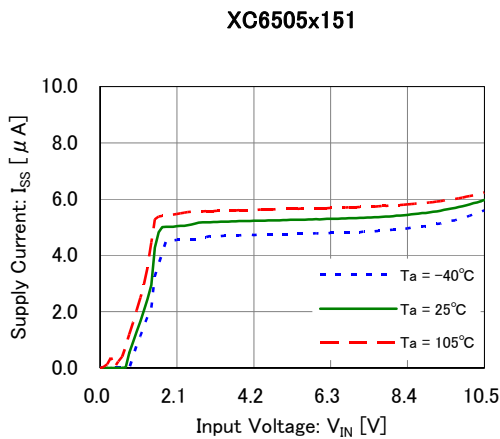

■ TYPICAL PERFORMANCE CHARACTERISTICS (Continued)

(5) Output Voltage vs. Ambient Temperature

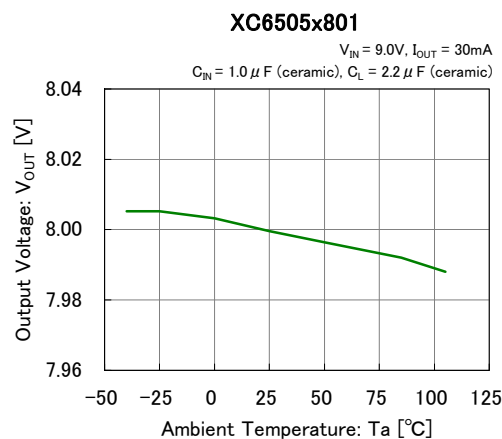
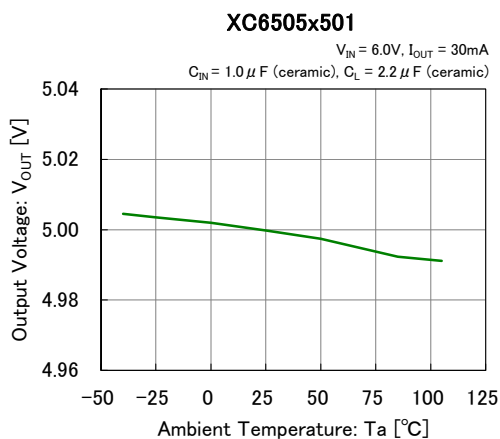
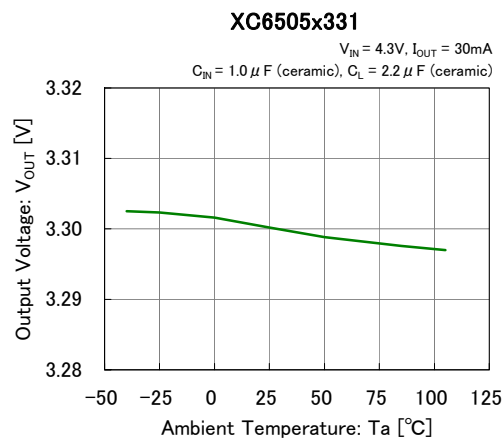
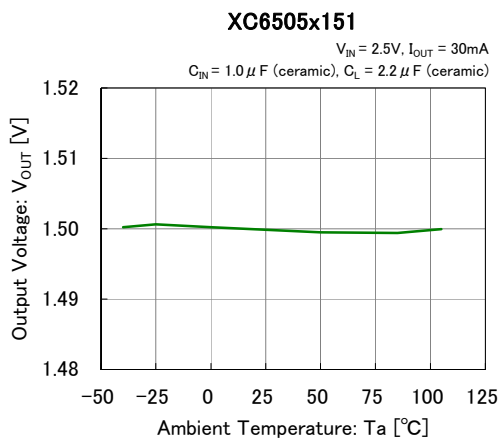

(6) Input Rising Response Time

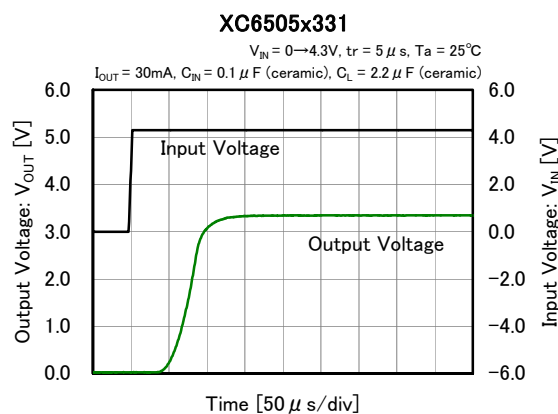
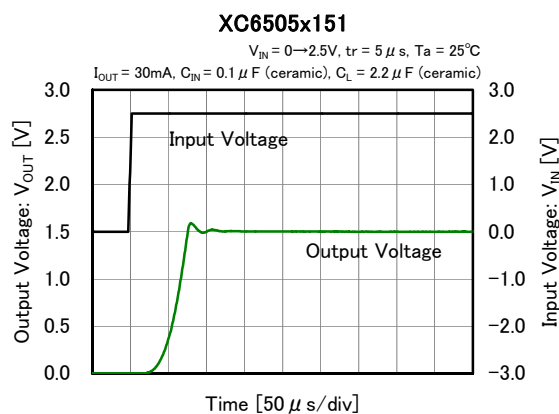

TYPICAL PERFORMANCE CHARACTERISTICS (Continued)

(6) Input Rising Response Time

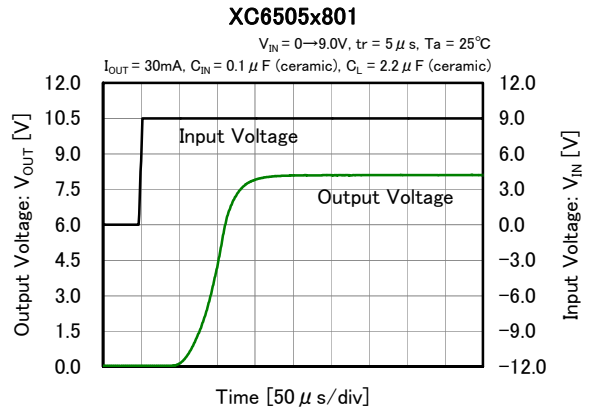
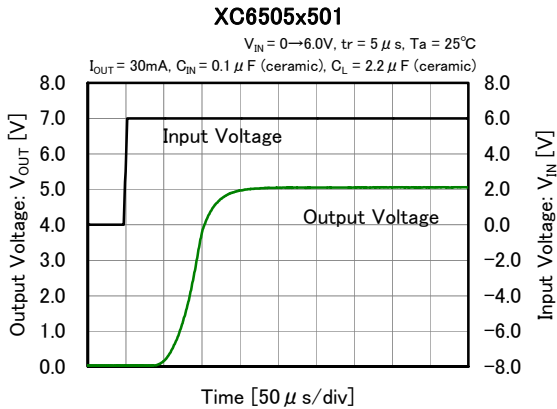

(7) CE Rising Response Time

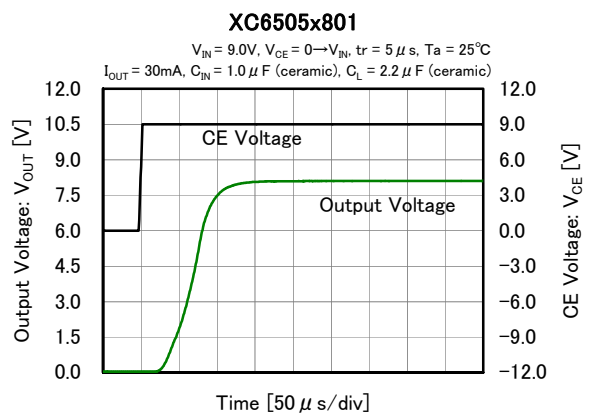
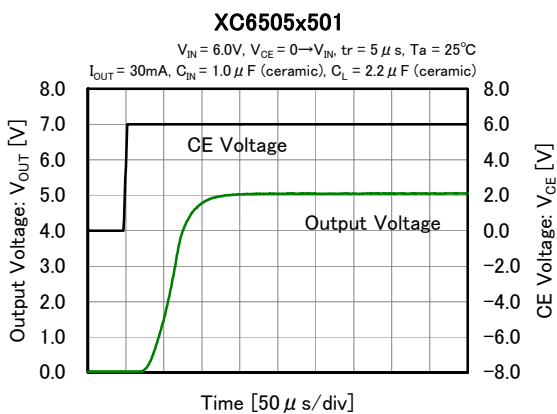
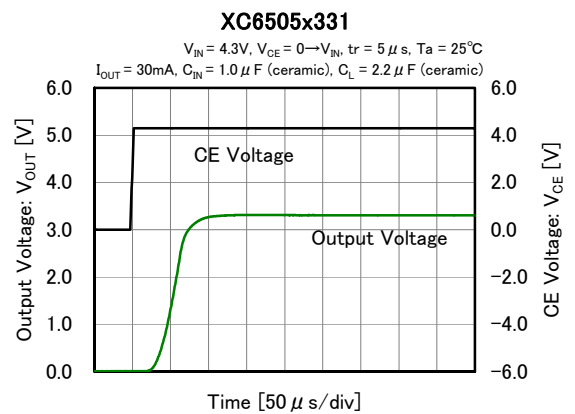
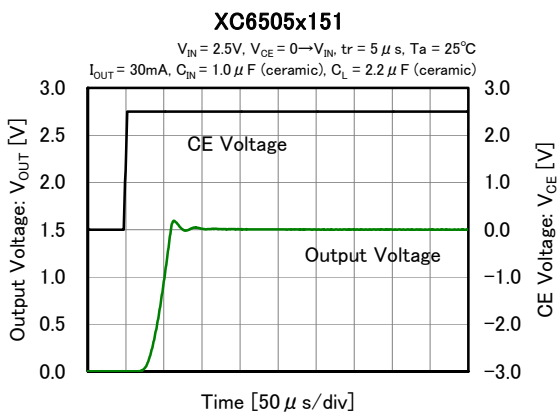

■ TYPICAL PERFORMANCE CHARACTERISTICS (Continued)

(8) Rush Current

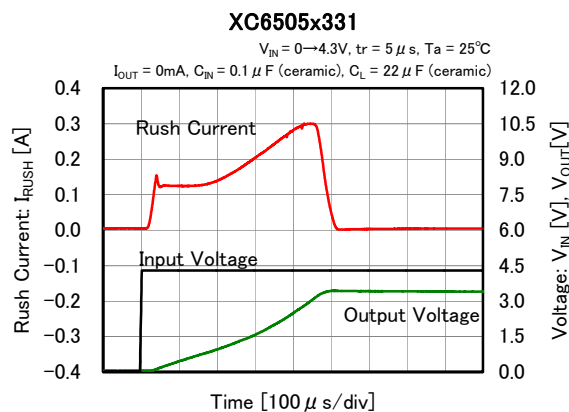
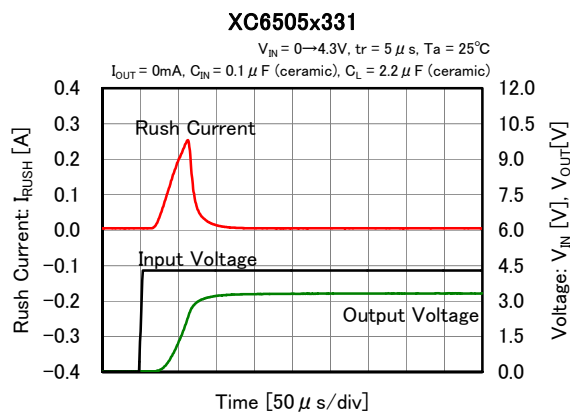

(9) Input Transient Response

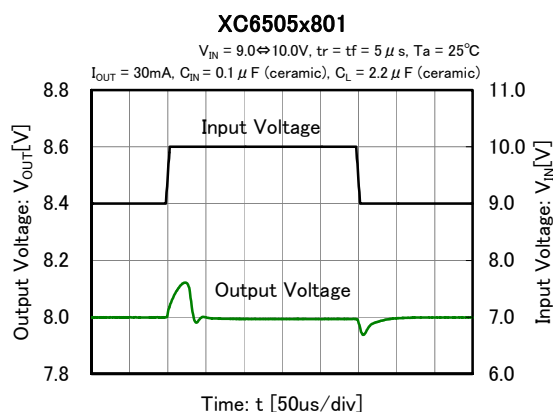
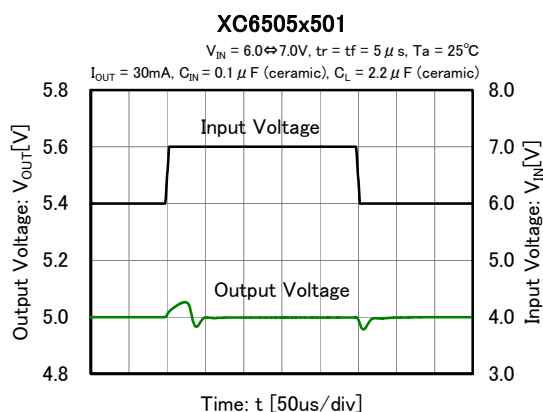
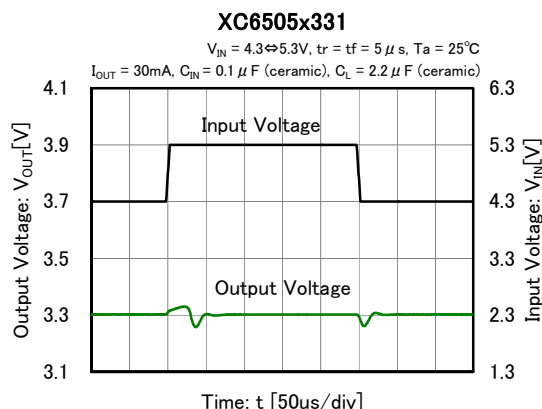
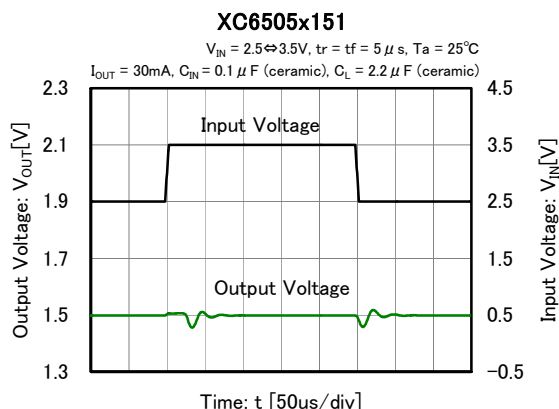

TYPICAL PERFORMANCE CHARACTERISTICS (Continued)

(10) Load Transient Response

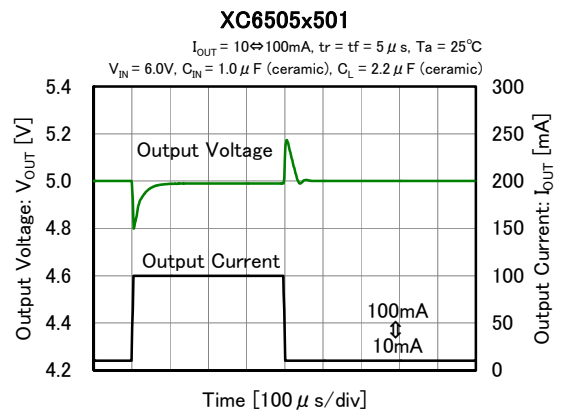
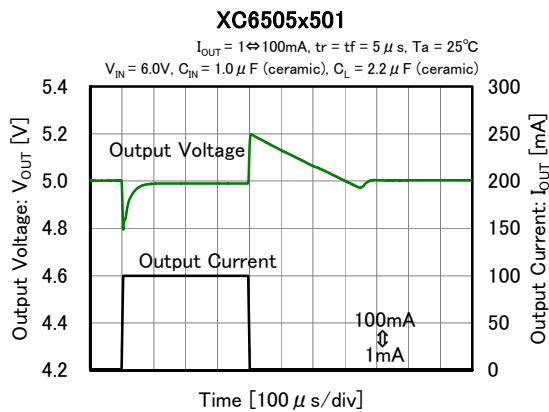
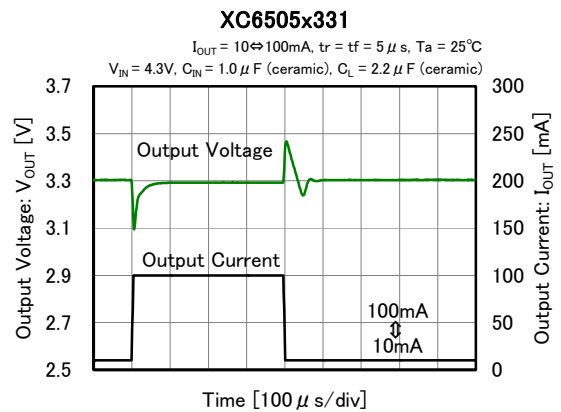
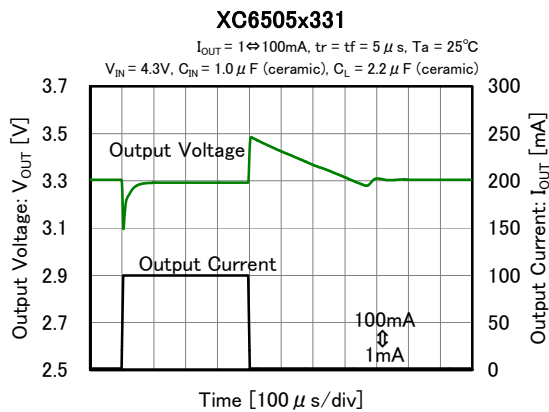
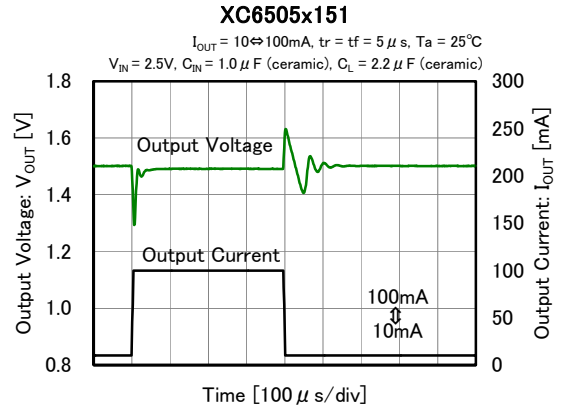
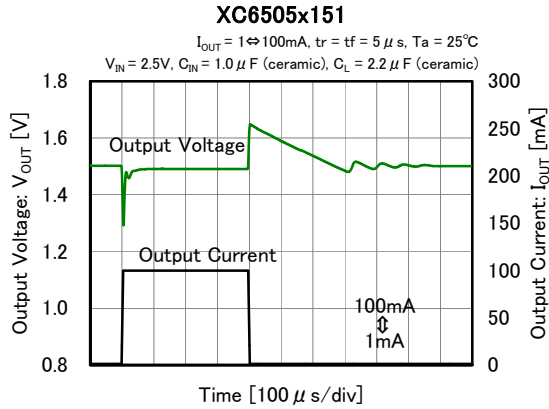

■ TYPICAL PERFORMANCE CHARACTERISTICS (Continued)

(10) Load Transient Response

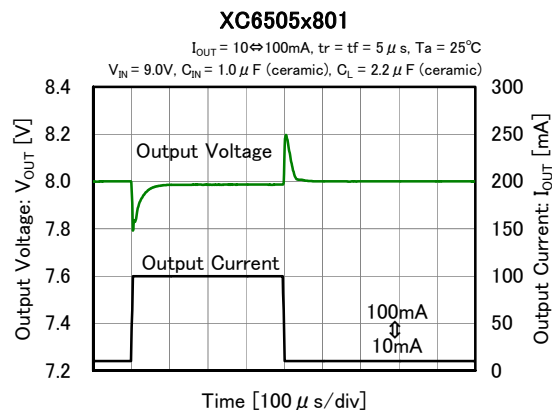
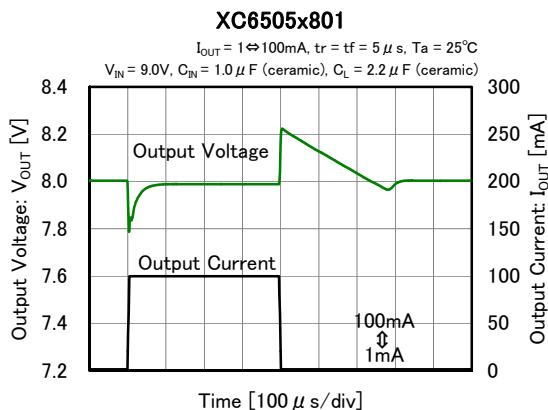

(11) Ripple Rejection Rate

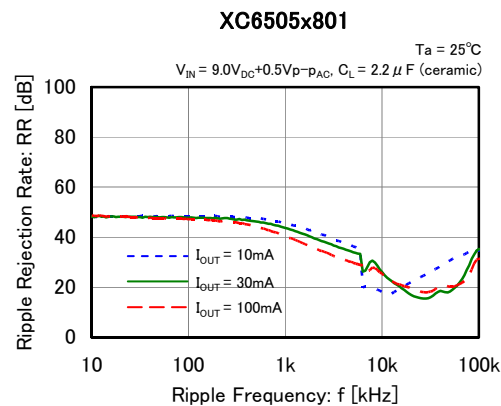
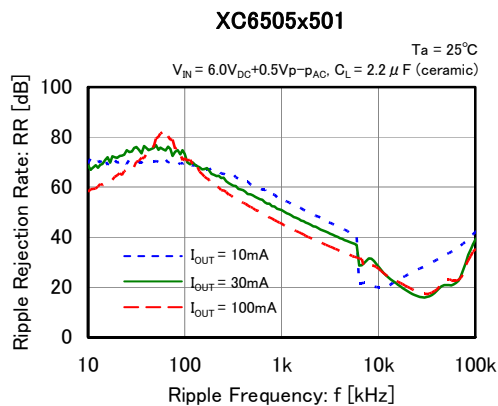
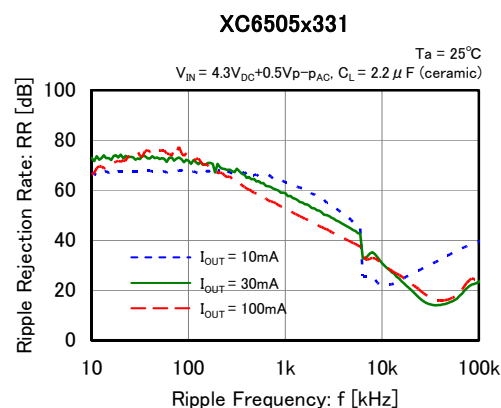
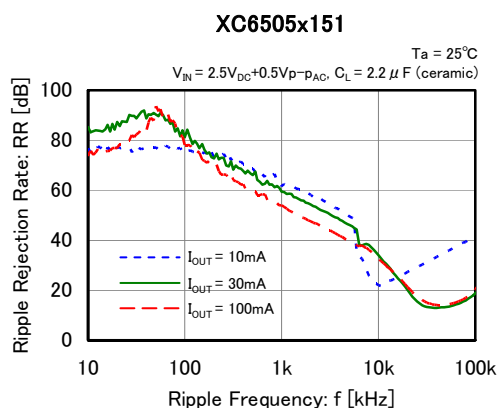

PACKAGING INFORMATION

● USP-6C

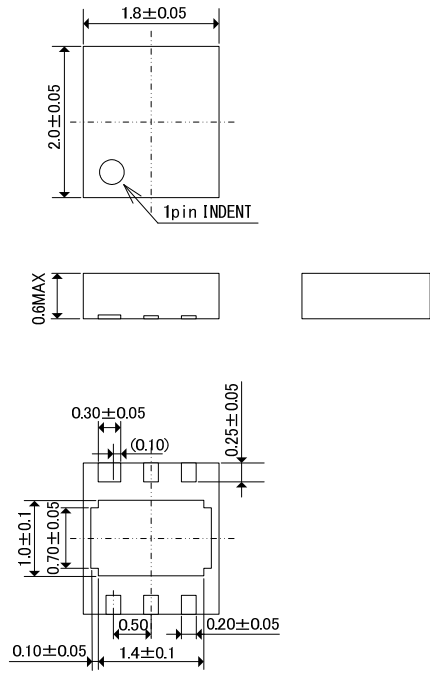

● SOT-25

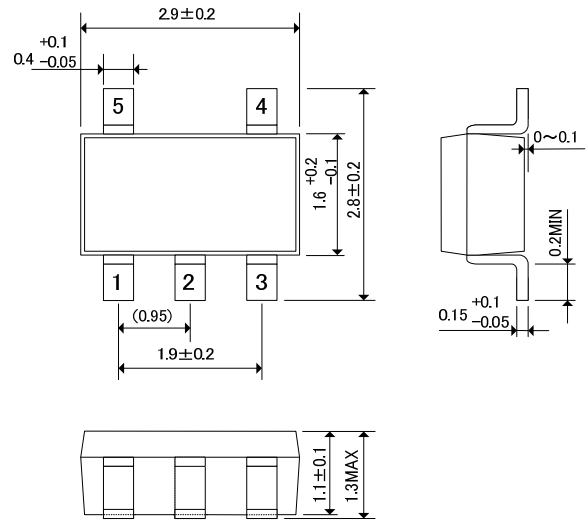

● SOT-89-5

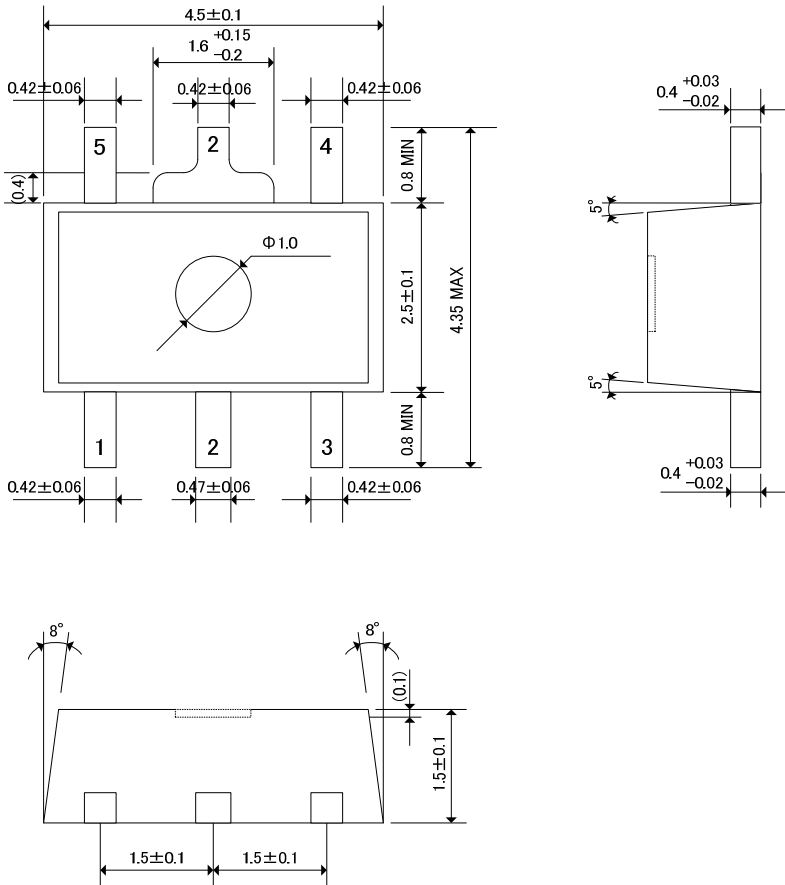

PACKAGING INFORMATION (Continued)

● USP-6C Reference Pattern Layout

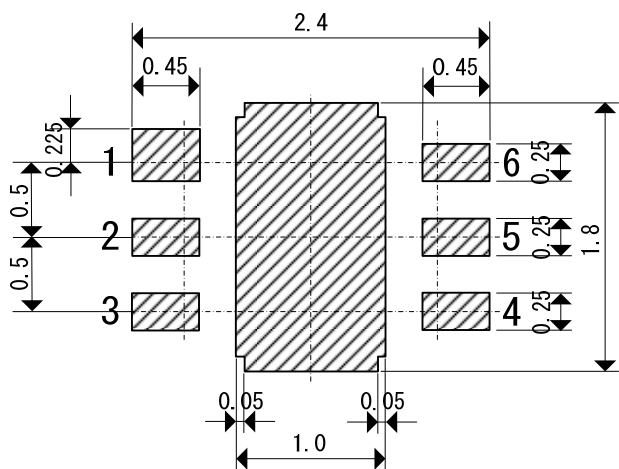

● USP-6C Reference Metal Mask Design

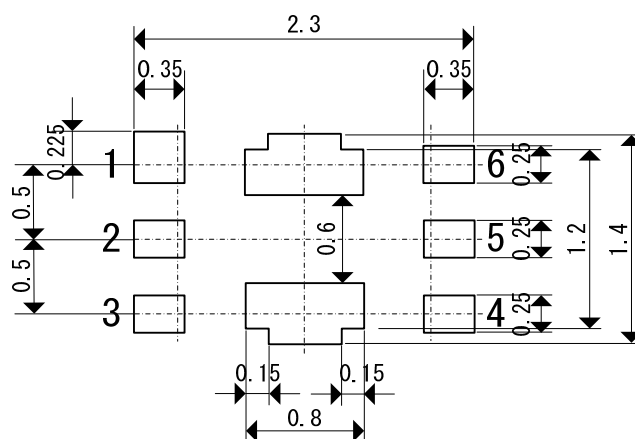

PACKAGING INFORMATION (Continued)

- USP-6C Power Dissipation

Power dissipation data for the USP-6C is shown in this page.

The value of power dissipation varies with the mount board conditions.

Please use this data as one of reference data taken in the described condition.

1. Measurement Condition (Reference data)

- Condition: Mount on a board
- Ambient: Natural convection
- Soldering: Lead (Pb) free
- Board: Dimensions 40 x 40 mm (1600 mm² in one side)
Copper (Cu) traces occupy 50% of the board area
In top and back faces
Package heat-sink is tied to the copper traces
- Material: Glass Epoxy (FR-4)
- Thickness: 1.6 mm
- Through-hole: 4 x 0.8 Diameter

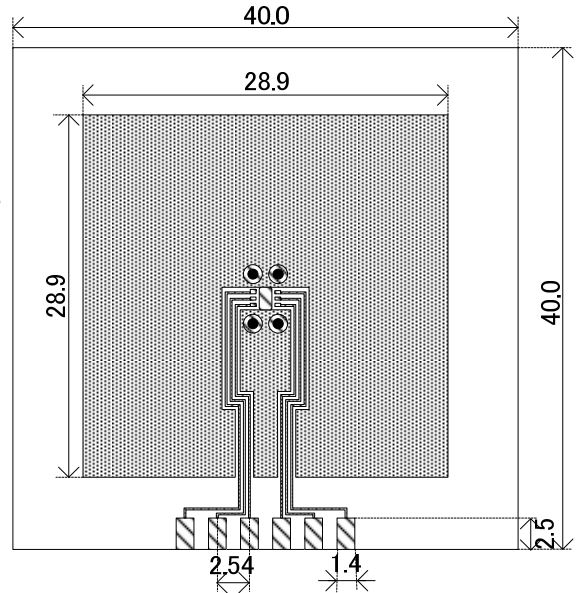

Evaluation Board (Unit: mm)

Board Mount ($T_j \text{ max} = 125^\circ\text{C}$)

Ambient Temperature ($^\circ\text{C}$)	Power Dissipation Pd (mW)	Thermal Resistance ($^\circ\text{C}/\text{W}$)
25	1000	100.00
105	200	

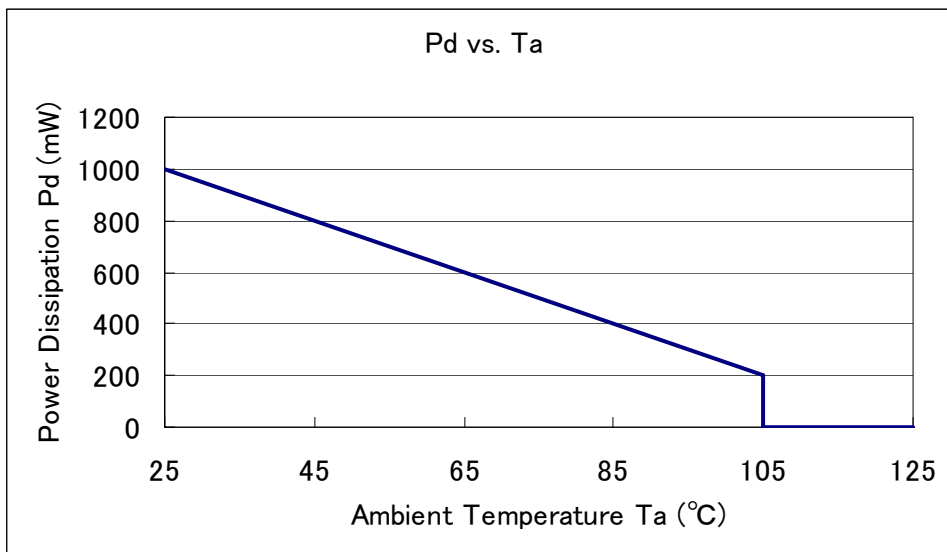

■ PACKAGING INFORMATION (Continued)

● SOT-25 Power Dissipation

Power dissipation data for the SOT-25 is shown in this page.
The value of power dissipation varies with the mount board conditions.
Please use this data as one of reference data taken in the described condition.

1. Measurement Condition (Reference data)

- Condition: Mount on a board
- Ambient: Natural convection
- Soldering: Lead (Pb) free
- Board: Dimensions 40 x 40 mm (1600 mm² in one side)
Copper (Cu) traces occupy 50% of the board area
In top and back faces
Package heat-sink is tied to the copper traces
(Board of SOT-26 is used.)
- Material: Glass Epoxy (FR-4)
- Thickness: 1.6 mm
- Through-hole: 4 x 0.8 Diameter

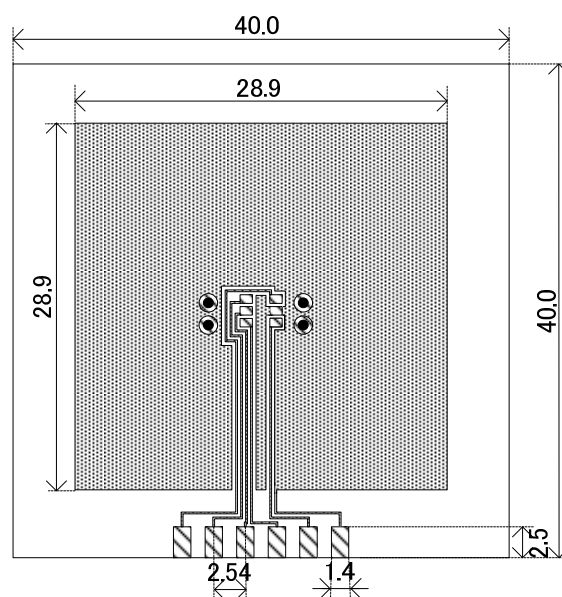

Evaluation Board (Unit: mm)

2. Power Dissipation vs. Ambient Temperature

Board Mount ($T_j \text{ max} = 125^\circ\text{C}$)

Ambient Temperature (°C)	Power Dissipation Pd (mW)	Thermal Resistance (°C/W)
25	600	166.67
105	120	

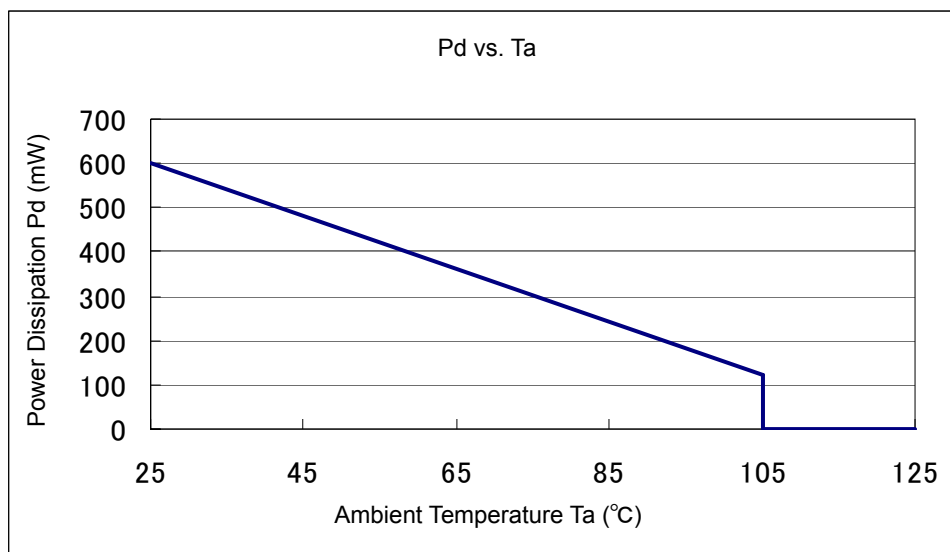

PACKAGING INFORMATION (Continued)

SOT-89-5 Power Dissipation

Power dissipation data for the SOT-89-5 is shown in this page.
 The value of power dissipation varies with the mount board conditions.
 Please use this data as one of reference data taken in the described condition.

1. Measurement Condition (Reference data)

- Condition: Mount on a board
- Ambient: Natural convection
- Soldering: Lead (Pb) free
- Board: Dimensions 40 x 40 mm (1600 mm² in one side)
 Copper (Cu) traces occupy 50% of the board area
 In top and back faces
 Package heat-sink is tied to the copper traces
- Material: Glass Epoxy (FR-4)
- Thickness: 1.6 mm
- Through-hole: 5 x 0.8 Diameter

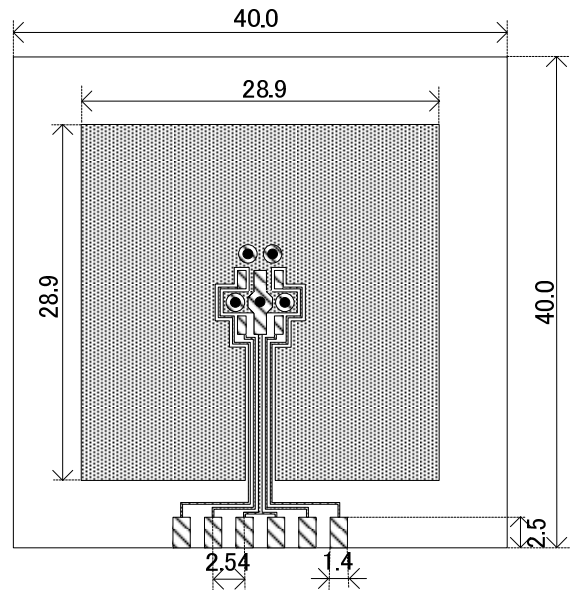

Evaluation Board (Unit: mm)

2. Power Dissipation vs. Ambient Temperature

Board Mount ($T_j \text{ max} = 125^\circ\text{C}$)

Ambient Temperature (°C)	Power Dissipation Pd (mW)	Thermal Resistance (°C/W)
25	1300	76.92
105	260	

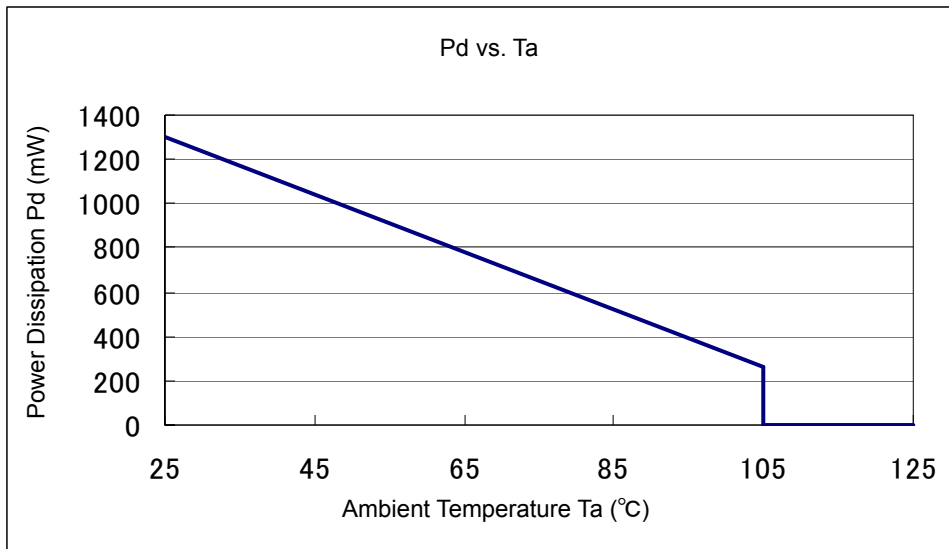

MARKING RULE

● USP-6C

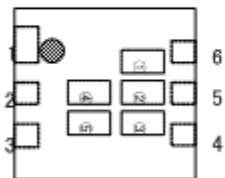

● SOT-25

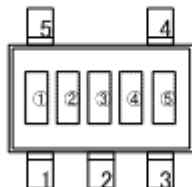

● SOT-89-5

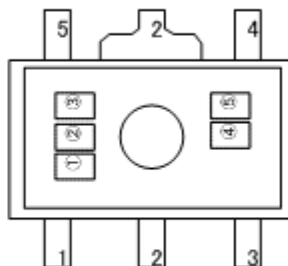

① represents product series

MARK	PACKAGE	PRODUCT SERIES
0	SOT-25/SOT-89-5	XC6505*****-G
P	USP-6C	XC6505*****-G

② represents type of regulator

	MARK				PRODUCT SERIES
	OUTPUT VOLTAGE =1.5~3.0V	OUTPUT VOLTAGE =3.1~5.0V	OUTPUT VOLTAGE =5.1~7.0V	OUTPUT VOLTAGE =7.1~8.0V	
TYPE OF REGULATOR "A"	0	1	2	3	XC6505A*****-G
TYPE OF REGULATOR "B"	4	5	6	7	XC6505B*****-G

③ represents output voltage

MARK	OUTPUT VOLTAGE (V)			MARK	OUTPUT VOLTAGE (V)		
0	-	3.10	6.10	F	1.60	4.60	7.60
1	-	3.20	6.20	H	1.70	4.70	7.70
2	-	3.30	6.30	K	1.80	4.80	7.80
3	-	3.40	6.40	L	1.90	4.90	7.90
4	-	3.50	6.50	M	2.00	5.00	8.00
5	-	3.60	6.60	N	2.10	5.10	-
6	-	3.70	6.70	P	2.20	5.20	-
7	-	3.80	6.80	R	2.30	5.30	-
8	-	3.90	6.90	S	2.40	5.40	-
9	-	4.00	7.00	T	2.50	5.50	-
A	-	4.10	7.10	U	2.60	5.60	-
B	-	4.20	7.20	V	2.70	5.70	-
C	-	4.30	7.30	X	2.80	5.80	-
D	-	4.40	7.40	Y	2.90	5.90	-
E	1.50	4.50	7.50	Z	3.00	6.00	-

④⑤ represents production lot number

01~09, 0A~0Z, 11~9Z, A1~A9, AA~AZ, B1~ZZ repeated.

(G, I, J, O, Q, W excluded)

*No character inversion used.

1. The product and product specifications contained herein are subject to change without notice to improve performance characteristics. Consult us, or our representatives before use, to confirm that the information in this datasheet is up to date.
2. The information in this datasheet is intended to illustrate the operation and characteristics of our products. We neither make warranties or representations with respect to the accuracy or completeness of the information contained in this datasheet nor grant any license to any intellectual property rights of ours or any third party concerning with the information in this datasheet.
3. Applicable export control laws and regulations should be complied and the procedures required by such laws and regulations should also be followed, when the product or any information contained in this datasheet is exported.
4. The product is neither intended nor warranted for use in equipment of systems which require extremely high levels of quality and/or reliability and/or a malfunction or failure which may cause loss of human life, bodily injury, serious property damage including but not limited to devices or equipment used in 1) nuclear facilities, 2) aerospace industry, 3) medical facilities, 4) automobile industry and other transportation industry and 5) safety devices and safety equipment to control combustions and explosions. Do not use the product for the above use unless agreed by us in writing in advance.
5. Although we make continuous efforts to improve the quality and reliability of our products; nevertheless Semiconductors are likely to fail with a certain probability. So in order to prevent personal injury and/or property damage resulting from such failure, customers are required to incorporate adequate safety measures in their designs, such as system fail safes, redundancy and fire prevention features.
6. Our products are not designed to be Radiation-resistant.
7. Please use the product listed in this datasheet within the specified ranges.
8. We assume no responsibility for damage or loss due to abnormal use.
9. All rights reserved. No part of this datasheet may be copied or reproduced unless agreed by Torex Semiconductor Ltd in writing in advance.

TOREX SEMICONDUCTOR LTD.

X-ON Electronics

Largest Supplier of Electrical and Electronic Components

Click to view similar products for [LDO Voltage Regulators](#) category:

Click to view products by [Torex Semiconductor](#) manufacturer:

Other Similar products are found below :

[L79M05TL-E](#) [PT7M8202B12TA5EX](#) [TCR3DF185,LM\(CT](#) [TCR3DF24,LM\(CT](#) [TCR3DF285,LM\(CT](#) [TCR3DF31,LM\(CT](#)
[TCR3DF45,LM\(CT](#) [MP2013GQ-33-Z](#) [059985X](#) [NCP4687DH15T1G](#) [701326R](#) [TCR2EN28,LF\(S](#) [NCV8170AXV250T2G](#)
[TCR3DF27,LM\(CT](#) [TCR3DF19,LM\(CT](#) [TCR3DF125,LM\(CT](#) [TCR2EN18,LF\(S](#) [AP2112R5A-3.3TRG1](#) [AP7315-25W5-7](#)
[IFX30081LDVGRNXUMA1](#) [NCV47411PAAJR2G](#) [AP2113KTR-G1](#) [AP2111H-1.2TRG1](#) [ZLDO1117QK50TC](#) [AZ1117IH-1.8TRG1](#)
[AZ1117ID-ADJTRG1](#) [TCR3DG12,LF](#) [MIC5514-3.3YMT-T5](#) [MIC5512-1.2YMT-T5](#) [MIC5317-2.8YM5-T5](#) [SCD7912BTG](#)
[NCP154MX180270TAG](#) [SCD33269T-5.0G](#) [NCV8170BMX330TCG](#) [NCV8170AMX120TCG](#) [NCP706ABMX300TAG](#)
[NCP153MX330180TCG](#) [NCP114BMX075TCG](#) [MC33269T-3.5G](#) [CAT6243-ADJCMT5T](#) [TCR3DG33,LF](#) [AP2127N-1.0TRG1](#)
[TCR4DG35,LF](#) [LT1117CST-3.3](#) [TAR5S15U\(TE85L,F\)](#) [TAR5S18U\(TE85L,F\)](#) [TCR3UG19A,LF](#) [TCR4DG105,LF](#) [NCV8170AMX360TCG](#)
[MIC94310-NYMT-T5](#)