

XC9128/XC9129 Series

ETR0411-013

1A Driver Transistor Built-In, Step-Up DC/DC Converters

☆Green Operation Compatible

■ GENERAL DESCRIPTION

The XC9128/XC9129 series are synchronous step-up DC/DC converters with a 0.2Ω (TYP.) N-channel driver transistor and a synchronous 0.2Ω (TYP.) P-channel switching transistor built-in. A highly efficient and stable current can be supplied up to 1.0A by reducing ON resistance of the built-in transistors.

With a high switching frequency of 1.2MHz, a small inductor is selectable making the series ideally suited for applications requiring low profile or space saving solutions. With the MODE pin, the series provides mode selection of PWM control or PFM/PWM automatic switching control. In the PWM/PFM automatic switching mode, the series switches from PWM to PFM to reduce switching loss when load current is small. When load current is large, the series switches automatically to the PWM mode so that high efficiency is achievable over a wide range of load conditions. The series also provides small output ripple from light to large loads by using the built-in circuit which enables the smooth transition between PWM and PFM.

With a adaptor enable function of the XC9128 series, when a voltage higher than the input voltage is applied to the output, the input and the output become isolated making it possible for the IC to work in parallel with the likes of an AC adaptor.

■ APPLICATIONS

- Digital audio equipment
- Digital still cameras / Camcorders
- Computer Mouses
- Multi-function power supplies

■ FEATURES

High Efficiency, Large Current Step-Up Converter

Output Current	: 150mA @ $V_{OUT}=3.3V$, $V_{IN}=0.9V$ 500mA @ $V_{OUT}=3.3V$, $V_{IN}=1.8V$
Input Voltage Range	: 0.8V ~ 6.0V : 1.8V ~ 5.3V (Externally set)
Output Voltage Setting Range	: Set up freely with a reference voltage supply of 0.45V ($\pm 0.010V$) & external components
Oscillation Frequency	: 1.2MHz (Fixed oscillation frequency accuracy $\pm 15\%$)
Input Current	: 1.0A
Maximum Current Limit	: 1.2A (MIN.), 2.0A (MAX.)
Control	: PWM, PWM/PFM control externally selectable
High Speed Transient Response	: 100mV @ $V_{OUT}=3.3V$, $V_{IN}=1.8V$, $I_{OUT}=10mA \rightarrow 100mA$
Protection Circuits	: Thermal shutdown Integral latch method (Over current limit)
Soft-Start Time	: 5ms (TYP.) internally set
Ceramic Capacitor Compatible	
Adaptor Enable Function (XC9128 series)	
Flag Output (XC9128 series)	: Open-drain output
Operating Ambient Temperature	: -40 ~ 85°C
Packages	: MSOP-10, USP-10B
Environmentally Friendly	: EU RoHS Compliant, Pb Free

■ TYPICAL APPLICATION CIRCUIT

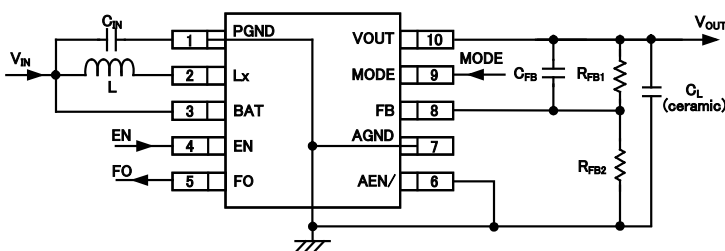

■ TYPICAL PERFORMANCE CHARACTERISTICS

● Efficiency vs. Output Current

XC9128B45CD

$L=4.7 \mu H$ (HLTF5022-LC), $C_L=30 \mu F$ (LMK212BJ106KG $\times 3$)
 $V_{OUT}=3.3V$, $V_{EN}=6V$, $V_{FO}=OPEN$, $V_{AEN}=0V$
 $R_{FB1}=270k \Omega$, $R_{FB2}=43k \Omega$, $C_{FB}=12pF$, $C_{IN}=10 \mu F$

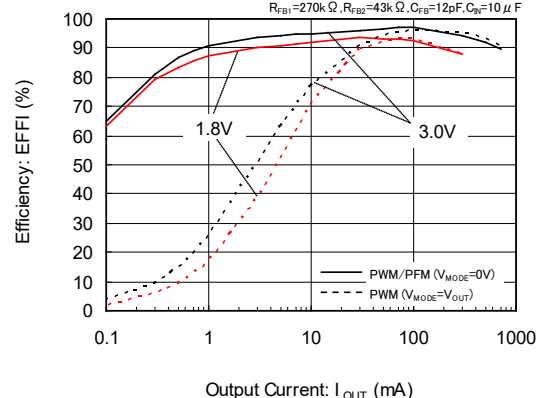

■ BLOCK DIAGRAM

● XC9128 Series

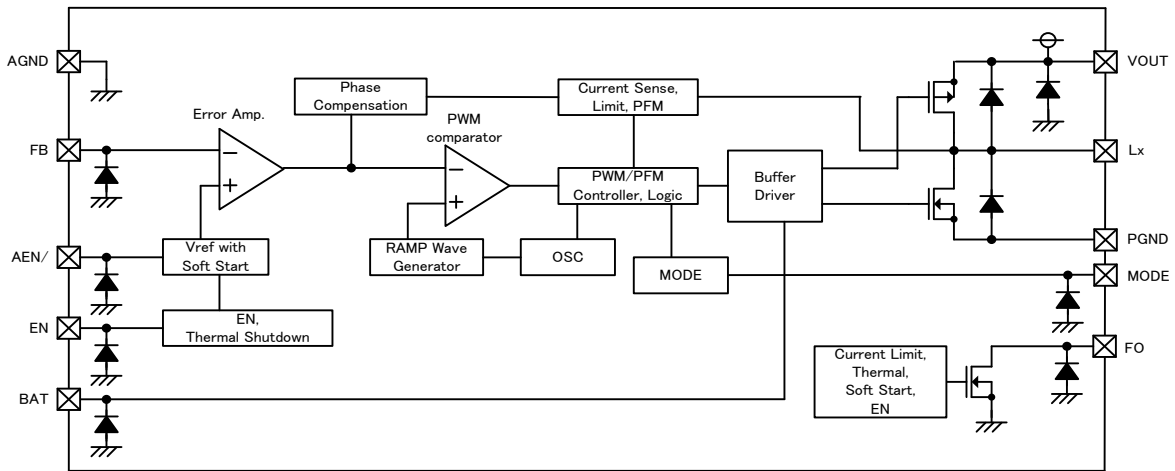

● XC9129 Series

The XC9129 series does not have AEN/ pin and FO pin.

■ PRODUCT CLASSIFICATION

● Ordering Information

XC9128①②③④⑤⑥-⑦ ^(*).....Adaptor Chip Enable Pin and Flag Output Pin are added

DESIGNATOR	ITEM	SYMBOL	DESCRIPTION
①	Integral Protection	B	With integral protection
		D	Without integral protection
②③	Reference Voltage	45	Fixed reference voltage 0.45V ②=4, ③=5
④	Oscillation Frequency	C	1.2MHz
⑤⑥-⑦ ^(*)	Packages (Order Unit)	AR	MSOP-10 (1,000pcs/Reel)
		AR-G	MSOP-10 (1,000pcs/Reel)
		DR	USP-10B (3,000pcs/Reel)
		DR-G	USP-10B (3,000pcs/Reel)

XC9129①②③④⑤⑥-⑦ ^(*).....Adaptor Chip Enable Pin and Flag Output Pin are not added

DESIGNATOR	ITEM	SYMBOL	DESCRIPTION
①	Integral Protection	D	Without integral protection
②③	Reference Voltage	45	Fixed reference voltage 0.45V ②=4, ③=5
④	Oscillation Frequency	C	1.2MHz
⑤⑥-⑦ ^(*)	Package (Order Unit)	DR	USP-10B (3,000pcs/Reel)
		DR-G	USP-10B (3,000pcs/Reel)

^(*) The "-G" suffix denotes Halogen and Antimony free as well as being fully EU RoHS compliant.

PIN CONFIGURATION

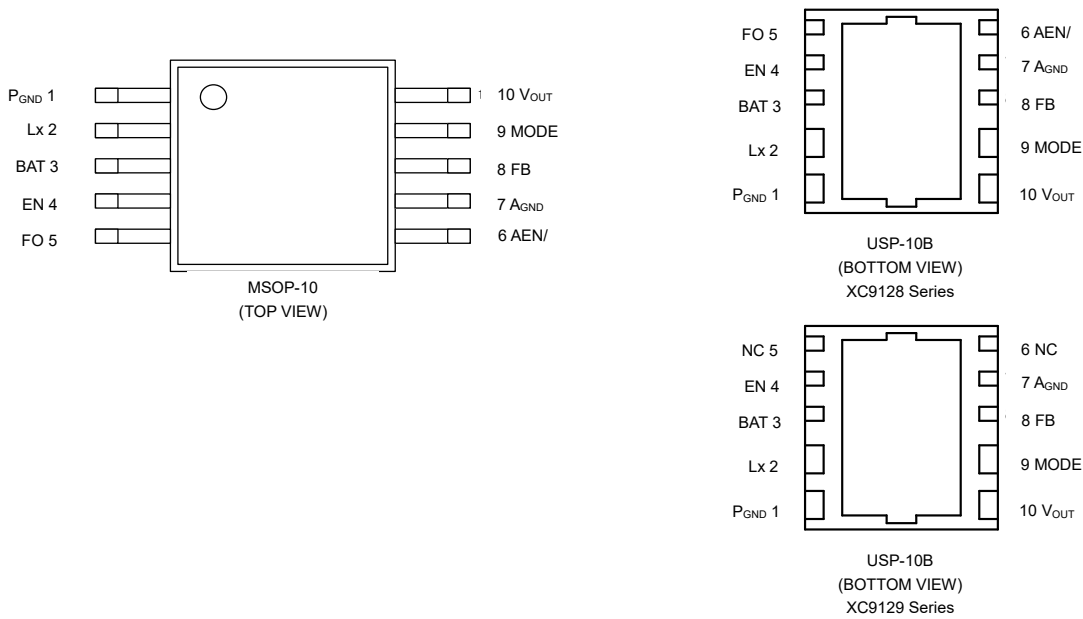

PIN ASSIGNMENT

PIN NUMBER			PIN NAME	FUNCTION
MSOP-10*	USP-10B* (XC9128)	USP-10B* (XC9129)		
1	1	1	PGND	Power Ground
2	2	2	Lx	Output of Internal Power Switch
3	3	3	BAT	Battery Input
4	4	4	EN	Chip Enable
5	5	-	FO	Flag Output
6	6	-	AEN/	Adaptor Enable
7	7	7	AGND	Analog Ground
8	8	8	FB	Output Voltage Monitor
9	9	9	MODE	Mode Switch
10	10	10	VOUT	Output Voltage
-	-	5, 6	NC	No Connection

* For MSOP-10 and USP-10B packages, please short the GND pins (pins 1 and 7).

* The dissipation pad for the USP-10B package should be solder-plated following the recommended mount pattern and metal masking so as to enhance mounting strength and heat release. If the pad needs to be connected to other pins, it should be connected to the Ground pins (pins 1 and 7).

■ FUNCTION CHART

1. EN, AEN/ Pin Function

●XC9128 Series

EN PIN	AEN/ PIN	FB PIN VOLTAGE	IC OPERATIONAL STATE	SOFT-START FUNCTION
L→H	L	-	Operation	Available
H	H→L	Lower than $0.45 \times 0.8V$	Operation	Available
H	H→L	Higher than $0.45 \times 0.95V$	Operation	Not Available
H	H	-	Step-Up Operation Shut-Down	-
L	L	-	Disable	-
L	H	-	Disable	-

* Do not leave the EN and AEN/ Pins open.

●XC9129 Series

EN PIN	IC OPERATIONAL STATE
H	Operation
L	Disable

* Do not leave the EN Pin open.

2. MODE Pin Function

●XC9128/XC9129 Series

MODE PIN	FUNCTION
H	PWM Control
L	PWM/PFM Automatic Switching Control

* Do not leave the MODE Pin open.

ABSOLUTE MAXIMUM RATINGS

PARAMETER		SYMBOL	RATINGS	UNITS
V _{OUT} Pin Voltage		VOUT	-0.3 ~ 6.5	V
AEN/ Pin Voltage ^(*)2)		VAEN/	-0.3 ~ 6.5	V
FO Pin Voltage ^(*)2)		VFO	-0.3 ~ 6.5	V
FO Pin Current ^(*)2)		IFO	10	mA
FB Pin Voltage		VFB	-0.3 ~ 6.5	V
BAT Pin Voltage		VBAT	-0.3 ~ 6.5	V
MODE Pin Voltage		VMODE	-0.3 ~ 6.5	V
EN Pin Voltage		VEN	-0.3 ~ 6.5	V
L _x Pin Voltage		VL _x	-0.3 ~ V _{OUT} + 0.3	V
L _x Pin Current		IL _x	2000	mA
Power Dissipation (Ta=25°C)	MSOP-10	Pd	350	mW
			500 (40mm x 40mm Standard board) ^(*)1)	
	USP-10B		150	
			500 (40mm x 40mm Standard board) ^(*)1)	
Operating Ambient Temperature		Topr	-40 ~ 85	°C
Storage Temperature		Tstg	-55 ~ 125	°C

AGND, PGND is the standard voltage for all of voltages.

^(*)1) This power dissipation figure shown is PCB mounted and is for reference only.

The mounting condition is please refer to PACKAGING INFORMATION.

^(*)2) The XC9129 series does not have AEN/ pin and FO pin. These pins are available only in the XC9128 series.

ELECTRICAL CHARACTERISTICS

XC9128/XC9129 Series

Ta=25°C

PARAMETER	SYMBOL	CONDITIONS	MIN.	TYP.	MAX.	UNITS	CIRCUIT
Input Voltage	V _{IN}	-	-	-	6.0	V	-
FB Voltage	V _{FB}	V _{OUT} =V _{IN} =3.3V, V _{FO} =0V ^(*)8) Voltage to start oscillation during V _{FB} = 0.46V → 0.44V	0.44	0.45	0.46	V	④
Output Voltage Setting Range	V _{OUTSET}	-	1.8	-	5.3	V	①
Operation Start Voltage	V _{ST1}	Connect to external components, R _L =1kΩ	-	-	0.8	V	①
		Connect to external components, R _L =33Ω	-	-	0.9 ^(*)1)	V	①
Oscillation Start Voltage	V _{ST2}	Voltage to start oscillation during V _{IN} =0V → 1V, R _L =1kΩ	-	0.8	-	V	①
Operation Hold Voltage	V _{HLD}	Connect to external components, R _L =1kΩ	-	0.7	-	V	①
Supply Current 1	I _{DD1}	V _{IN} = V _{OUT} =3.3V, V _{FB} =0.45V×0.9	-	3	6	mA	②
Supply Current 2 (XC9128)	I _{DD2}	V _{IN} = V _{OUT} =3.3V	-	30	80	μA	②
Supply Current 2 (XC9129)		V _{FB} =0.45V×1.1 (Oscillation stop), V _{MODE} =0V	-	28	78		
Input Pin Current	I _{BAT}	V _{IN} =3.3V, V _{OUT} =1.8V, V _{EN} =0V	-	2	10	μA	③
Stand-by Current	I _{STB}	V _{IN} = V _{OUT} =3.3V, V _{EN} =0V	-	2	10	μA	②
Oscillation Frequency	f _{OSC}	V _{IN} = V _{OUT} =3.3V, V _{FO} =0V ^(*)8) , V _{FB} =0.45V×0.9	1.02	1.20	1.38	MHz	④
Maximum Duty Cycle	MAXDTY	V _{IN} = V _{OUT} =3.3V, V _{FO} =0V ^(*)8) , V _{FB} =0.45V×0.9	85	92	96	%	④
Minimum Duty Cycle	MINDTY	V _{IN} = V _{OUT} =3.3V, V _{FO} =0V ^(*)8) , V _{FB} =0.45V×1.1	-	-	0	%	④
PFM Switching Current	I _{PFM}	Connect to external components, V _{MODE} =0V, R _L =330Ω	-	250	400	mA	①
Efficiency ^(*)2)	EFFI	Connect to external components, R _L =33Ω	-	93	-	%	①
Lx SW "Pch" ON Resistance	R _{LxP}	V _{IN} =V _{Lx} =V _{OUT} +50mV, V _{FB} =0.45V × 1.1 ^(*)3)	-	0.20	0.35 ^(*)1)	Ω	⑤
Lx SW "Nch" ON Resistance	R _{LxN}	V _{IN} =V _{OUT} =3.3V, Lx =50mV ^(*)4)	-	0.20 ^(*)1)	0.35 ^(*)1)	Ω	⑦
Lx Leak Current	I _{LXL}	V _{IN} =V _{OUT} = V _{Lx} , V _{FB} =0V	-	1	-	μA	⑤
Current Limit ^(*)5)	I _{LIM}	V _{OUT} >2.5V	1.2	1.5	2.0	A	①
Integral Latch Time (XC9128) ^(*)6)	t _{LAT}	Time to stop oscillation during R _L =33Ω → 3.3Ω, V _{FO} =L → H	-	3.5	-	ms	①
Integral Latch Time (XC9129) ^(*)6)		Time to stop oscillation during R _L =33Ω → 3.3Ω	-	3.5	-	ms	
Soft-Start Time 1	t _{SS1}	Time to start oscillation during V _{EN} =0V → V _{IN} at V _{IN} = V _{OUT} =3.3V, V _{FO} =0V, V _{FB} =0.45V×0.95	1.7	5.3	10.5	ms	④
Soft-Start Time 2 ^(*)7)	t _{SS2}	V _{IN} = V _{OUT} =3.3V, V _{FO} =0V, V _{FB} =0.45V×0.95 Time to start oscillation during V _{AEN} =V _{IN} →0V.	-	0.02	0.04	ms	④
Soft-Start Time 3 ^(*)7)	t _{SS3}	V _{IN} = V _{OUT} =3.3V, V _{FO} =0V, V _{FB} =0.45V×0.8 Time to start oscillation during V _{AEN} =V _{IN} →0V	1.7	5.3	10.5	ms	④
Thermal Shutdown Temperature	T _{TSD}	-	-	150	-	°C	-
Hysteresis Width	T _{HYS}	-	-	20	-	°C	-
Output Voltage Drop Protection ^(*)6)	V _{LVP}	V _{IN} =3.3V Voltage to stop oscillation during V _{OUT} =1.56V→1.3V	1.3	1.48	1.56	V	⑥
FO Output Current ^(*)7)	I _{FO_OUT}	V _{IN} =V _{OUT} =3.3V, V _{FO} =0.25V	1.3	1.7	2.2	mA	④
FO Leakage Current ^(*)7)	I _{FO_Leak}	V _{IN} = V _{OUT} =3.3V, V _{EN} =0V, V _{FO} =1V	-	0	1	μA	④

ELECTRICAL CHARACTERISTICS (Continued)

XC9128/XC9129 Series (Continued)

Ta=25°C

PARAMETER	SYMBOL	CONDITIONS	MIN.	TYP.	MAX.	UNIT	CIRCUIT
EN "H" Voltage	V _{ENH}	V _{IN} =V _{OUT} =3.3V, V _{FO} =0V ^{(*)8} Voltage to start oscillation during V _{FB} =0.45V×0.9, V _{EN} =0.2V→0.65V	0.65	-	6.0	V	④
EN "L" Voltage	V _{ENL}	V _{IN} =V _{OUT} =3.3V, V _{FO} =0V ^{(*)8} Voltage to stop oscillation during V _{FB} =0.45V×0.9, V _{EN} =0.65V→0.20V	AGND	-	0.2	V	④
MODE "H" Voltage	V _{MODEH}	R _L =330Ω, Voltage operates at PWM control	0.65	-	6.0	V	①
MODE "L" Voltage	V _{MODEL}	R _L =330Ω, Voltage operates at PFM control	AGND	-	0.2	V	①
AEN/ Voltage ^{(*)7}	V _{AEN/}	V _{IN} =V _{OUT} =3.3V, V _{FO} =0V Voltage to start oscillation during V _{AEN/} =0.9V→0.7V	0.7	0.8	0.9	V	④
EN "H" Current	I _{ENH}	V _{IN} =V _{OUT} =V _{FB} =V _{EN} =6.0V	-	-	0.1	μA	②
EN "L" Current	I _{ENL}	V _{IN} =V _{OUT} =V _{FB} =6.0V, V _{EN} =0V	-0.1	-	-	μA	②
MODE "H" Current	I _{MODEH}	V _{IN} =V _{OUT} =V _{FB} =V _{MODE} =6.0V	-	-	0.1	μA	②
MODE "L" Current	I _{MODEL}	V _{IN} =V _{OUT} =V _{FB} =6.0V, V _{MODE} =0V	-0.1	-	-	μA	②
AEN/ "H" Current ^{(*)7}	I _{AEN/H}	V _{IN} =V _{OUT} =V _{FB} =V _{AEN/} =6.0V	-	-	0.1	μA	②
AEN/ "L" Current ^{(*)7}	I _{AEN/L}	V _{IN} =V _{OUT} =6.0V, V _{EN} =0V, V _{AEN/} =0V	-0.1	-	-	μA	②
FB "H" Current	I _{FBH}	V _{IN} =V _{OUT} =V _{FB} =6.0V	-	-	0.1	μA	②
FB "L" Current	I _{FBL}	V _{IN} =V _{OUT} =6.0V, V _{FB} =0V	-0.1	-	-	μA	②

Test Conditions:

For the Circuit No.1, unless otherwise stated, V_{IN}=1.8V, V_{EN}=V_{MODE}=V_{FO}=3.3V, V_{AEN/}=0V ^{(*)8}

For the Circuit No.2, unless otherwise stated, V_{IN}=1.8V, V_{FB}=0V, V_{EN}=V_{MODE}=3.3V, V_{AEN/}=0V ^{(*)8}

For the Circuit No.3, unless otherwise stated, V_{IN}=1.8V, V_{OUT}=V_{EN}=V_{MODE}=3.3V, V_{FB}=0V

For the Circuit No.4, unless otherwise stated, V_{IN}=1.8V, V_{FB}=0V, V_{EN}=V_{MODE}=V_{pull}=V_{FO}=3.3V, V_{AEN/}=0V ^{(*)8}

For the Circuit No.5, unless otherwise stated, V_{IN}=3.3V, V_{AEN/}=0V ^{(*)8}

For the Circuit No.6, unless otherwise stated, V_{EN}=V_{MODE}=V_{pull}=V_{FO}=3.3V, V_{FB}=0V ^{(*)8}

For the Circuit No.7, unless otherwise stated, V_{EN}=V_{MODE}=3.3V

External Components:

For the Circuit No.1, R_{FB1}=270kΩ, R_{FB2}=43kΩ, C_{FB}=12pF, L=4.7μH(LTF5022 TDK), C_{L1}=22μF(ceramic), C_{L2}=10μF(ceramic), C_{IN}=10μF(ceramic)

For the Circuit No.2,3, C_{IN}=1μF(ceramic)

For the Circuit No.4,6, C_{IN}=1μF(ceramic), R_{pull}=300Ω

For the Circuit No.5, C_{IN}=1μF(ceramic), C_{OUT}=1μF(ceramic)

For the Circuit No.7, C_{IN}=1μF(ceramic), C_{OUT}=1μF(ceramic), SBD =XBS304S17(TOREX), R_{pull}=0.5Ω

*1 : Designed value

*2 : Efficiency ={(output voltage) X (output current)} ÷ {(input voltage) X (input current)} X 100

*3 : L_x SW "Pch" ON resistance=(V_{Lx}-V_{OUT} pin test voltage)÷100mA

*4 : Testing method of L_x SW "Nch" ON resistance is stated at test circuits.

*5 : Current flowing through the Nch driver transistor is limited.

*6 : The XC9128D/XC9129D type does not have integral latch protection and V_{LVP} function.
This is only available with the XC9128B type.

*7 : The XC9129 series does not have FO and AEN/ pins. These pins are only available in the XC9128 series.

*8 : The XC9129 series does not have FO and AEN/ pins. The AEN/FO functions are only effective for the test of the XC9128 series.

■ TYPICAL APPLICATION CIRCUIT

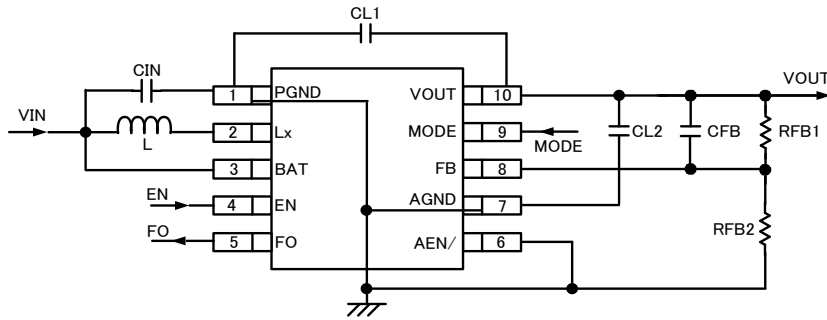

<Output Voltage Setting>

Output voltage can be set by adding external split resistors. Output voltage is determined by the following equation, based on the values of RFB1 and RFB2. The sum of RFB1 and RFB2 should normally be 500kΩ or less.

$$V_{OUT} = 0.45 \times (R_{FB1} + R_{FB2}) / R_{FB2}$$

The value of CFB, speed-up capacitor for phase compensation, should be $f_{ZFB} = 1 / (2 \times \pi \times C_{FB1} \times R_{FB1})$ which is in the range of 10 kHz to 60 kHz. Adjustments are depending on application, inductance (L), load capacitance (CL) and dropout voltage.

[Example of calculation]

When RFB1=270kΩ, RFB2=43kΩ,

$$V_{OUT1} = 0.45 \times (270k + 43k) / 43k = 3.276V$$

VOUT (V)	RFB1 (kΩ)	RFB2 (kΩ)	CFB (pF)
1.8	300	100	10
2.5	270	59	12
3.3	270	43	12
5.0	180	17.8	15

[External Components]

1.2MHz:

- L : 4.7 μH (LTF5022-4R7-LC TDK)
- : 4.7 μH (CDRH4D28C-4R7N SUMIDA)
- CL1 : 22 μF (ceramic)
- CL2 : 10 μF (ceramic)
- CIN : 10 μF (ceramic)

* CL1 should be selected in 10 μF or higher.

Capacitance CL1 + CL2 is recommended 30 μF or higher. (Ceramic capacitor compatible)

If CL1 is lower than 10 μF, operation may be unstable.

In case of the usage CL1 + CL2 < 30 μF, output ripple may increase so that we recommend that you fully check actual performance on the board.

* If using Tantalum or Electrolytic capacitors please be aware that ripple voltage will be higher due to the larger ESR (Equivalent Series Resistance) values of those types of capacitors. Please also note that the IC's operation may become unstable with such capacitors so we recommend that you fully check actual performance.

OPERATIONAL EXPLANATION

The XC9128/XC9129 series consists of a reference voltage source, ramp wave circuit, error amplifier, PWM comparator, phase compensation circuit, N-channel driver transistor, P-channel synchronous rectification switching transistor and current limiter circuit. The error amplifier compares the internal reference voltage with the FB pin feed back voltage via resistors R_{FB1} and R_{FB2}. Phase compensation is performed on the resulting error amplifier output, to input a signal to the PWM comparator to determine the turn-on time of the N-channel driver transistor during PWM operation. The PWM comparator compares, in terms of voltage level, the signal from the error amplifier with the ramp wave from the ramp wave circuit, and delivers the resulting output to the buffer driver circuit to cause the Lx pin to output a switching duty cycle. This process is continuously performed to ensure stable output voltage. The current feedback circuit monitors the N-channel driver transistor's turn-on current for each switching operation, and modulates the error amplifier output signal to provide multiple feedback signals. This enables a stable feedback loop even when a low ESR capacitor, such as a ceramic capacitor, is used, ensuring stable output voltage.

<Reference Voltage Source>

The source provides the reference voltage to ensure stable output of the DC/DC converter.

<Ramp Wave Circuit>

The ramp wave circuit determines switching frequency. The frequency is fixed internally at 1.2MHz. The Clock generated is used to produce ramp waveforms needed for PWM operation, and to synchronize all the internal circuits.

<Error Amplifier>

The error amplifier is designed to monitor output voltage. The amplifier compares the reference voltage with the feedback voltage divided by the internal resistors (R_{FB1} and R_{FB2}). When the FB pin is lower than the reference voltage, output voltage of the error amplifier increases. The gain and frequency characteristics of the error amplifier are optimized internally.

< Maximum Current Limit>

The current limiter circuit monitors the maximum current flowing through the N-channel driver transistor connected to the Lx pin, and features a combination of the current limit and latch function.

- ①When the driver current is greater than a specific level (equivalent to peak coil current), the maximum current limit function starts to operate and the pulses from the Lx pin turn off the N-channel driver transistor at any given time.
- ②When the driver transistor is turned off, the limiter circuit is then released from the maximum current limit detection state.
- ③At the next pulse, the driver transistor is turned on. However, the transistor is immediately turned off in the case of an over current state.
- ④ When the over current state is eliminated, the IC resumes its normal operation.

The XC9128B type waits for the over current state to end by repeating the steps ① through ③. If an over current state continues for several ms and the above three steps are repeatedly performed, the IC performs the function of latching the OFF state of the N-channel driver transistor, and goes into operation suspension mode. After being put into suspension mode, the IC can resume operation by turning itself off once and then re-starting via the EN pin, or by restoring power to the V_{IN} pin.

The XC9128D/XC9129D type does not have this latch function, so operation steps ① through ③ repeat until the over current state ends.

Integral latch time may be released from a over current detection state because of the noise. Depending on the state of a substrate, it may result in the case where the latch time may become longer or the operation may not be latched. Please locate an input capacitor as close as possible.

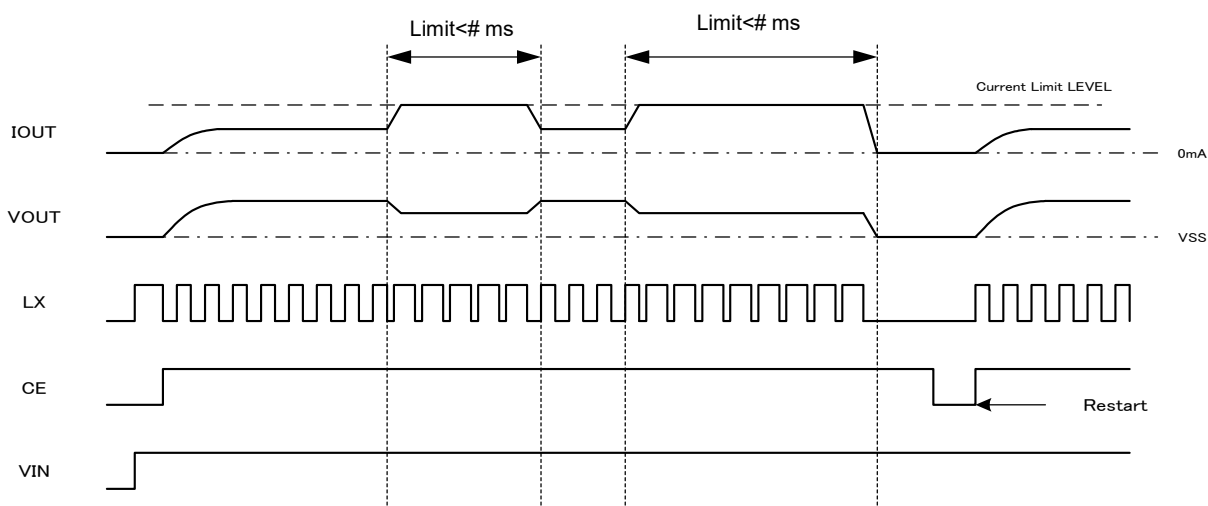

■ OPERATIONAL EXPLANATION (Continued)

<Thermal Shutdown>

For protection against heat damage, the thermal shutdown function monitors chip temperature. When the chip's temperature reaches 150°C (TYP.), the thermal shutdown circuit starts operating and the driver transistor will be turned off. At the same time, the output voltage decreases. When the temperature drops to 130°C (TYP.) after shutting off the current flow, the IC performs the soft start function to initiate output startup operation.

<MODE>

The MODE pin operates in PWM mode by applying a high level voltage and in PFM/PWM automatic switching mode by applying a low level voltage.

<Shut-Down>

The IC enters chip disable state by applying low level voltage to the EN pin. At this time, the Pch synchronous switching transistor turns on when $V_{IN} > V_{OUT}$ and vice versa the transistor turns off when $V_{IN} < V_{OUT}$.

<Adaptor Enable>

While the XC9128 series using step-up DC/DC converters in parallel with an added power source such as AC adaptors, the circuit needs the step-up DC/DC converter to be transient-efficient for sustaining output voltage in case the added power source runs down. The AEN/ pin voltage determines whether the added power source is supplied or not so that high-speed following operation is possible.

The IC starts operating although the driver transistor is off when a high level voltage is applied to the AEN/ pin after a high level voltage is also applied to the EN pin. If the AEN/ pin voltage changes from high level to low level while the EN pin sustains a high level voltage, the step-up operation starts with high-speed following mode (without soft-start).

The XC9129 series does not have adaptor enable function.

<Error Flag >

For the XC9128 series, the FO pin becomes high impedance during over current state, over temperature state, soft-start period, and shut-down period.

The XC9129 series does not have flag out function.

NOTE ON USE

1. Please do not exceed the stated absolute maximum ratings values.
2. The DC/DC converter / controller IC's performance is greatly influenced by not only the ICs' characteristics, but also by those of the external components. Care must be taken when selecting the external components.
3. Make sure that the PCB GND traces are as thick as possible, as variations in ground potential caused by high ground currents at the time of switching may result in instability of the IC.
4. Please mount each external component as close to the IC as possible and use thick, short traces to reduce the circuit impedance.
5. When the device is used in high step-up ratio, the current limit function may not work during excessive load current. In this case, the maximum duty cycle limits maximum current.
6. When the adaptor enable function is used in the below circuit, please use a diode with low reverse bias current. The sum of R_{AEN1} 's and R_{AEN2} 's resistance should be set to manage the reverse bias current.

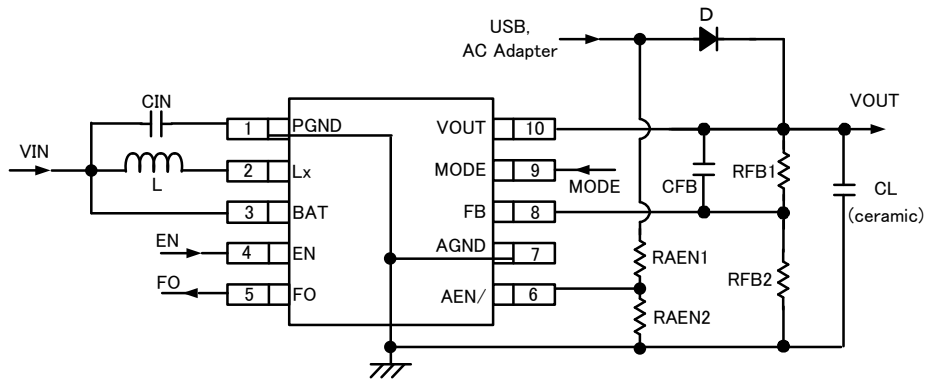

■ NOTE ON USE (Continued)

7. Pch synchronous switching transistor operation

The parasitic diode of the Pch synchronous transistor is placed between Lx (anode) and V_{OUT} (cathode), so that the power line can not be turned off from Lx to V_{OUT}. On the other hand, the power line switch from V_{OUT} to Lx is shown in the table below.

●XC9128 Series

EN Pin	AEN/Pin	P-channel Synchronous Switch Transistor Operation
H	H	OFF
H	L	Switching
L	H	OFF
L	L	Undefined

●XC9129 Series

EN Pin	P-channel Synchronous Switch Transistor Operation
H	Switching
L	Undefined

With the XC9128B type, when step-up operation stops as a result of the latch condition working when the maximum current limit level is reached, the synchronous P-channel transistor will remain ON.

8. The maximum current limiter controls the limit of the N-channel driver transistor by monitoring current flow. This function does not limit the current flow of the P-channel synchronous transistor.
9. The integral latch time of the XC9128B type, could be released from the maximum current detection state as a result of board mounting conditions. This may extend integral latch time or the level required for latch operation to function may not be reached. Please connect the output capacitor as close to the IC as possible.
10. With the XC9128B type, when the EN pin is left open or applied in the range of 0.2V ~ 0.65V, the integral latch or the V_{LVP} may not be able to release. Please make sure that the EN pin voltage is less than 0.2V or more than 0.65V, or use the XC9128D type, which does not have the integral latch and the LVP functions.
11. With the XC9128B type, please make the V_{OUT} pin voltage become more than 1.5V within the soft-start time, otherwise the V_{LVP} is detected. Also, the operation may become unstable, please test and verify the operation in the actual circuits thoroughly before use.
12. When used in small step-up ratios, the device may skip pulses during PWM control mode.

TEST CIRCUITS *1

< Circuit No.1 >

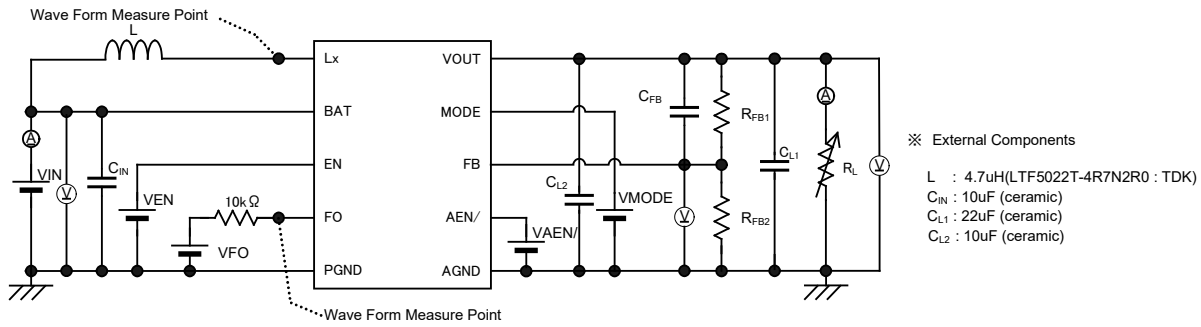

< Circuit No.2 >

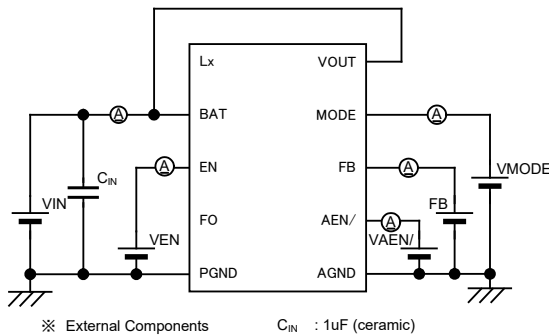

< Circuit No.3 >

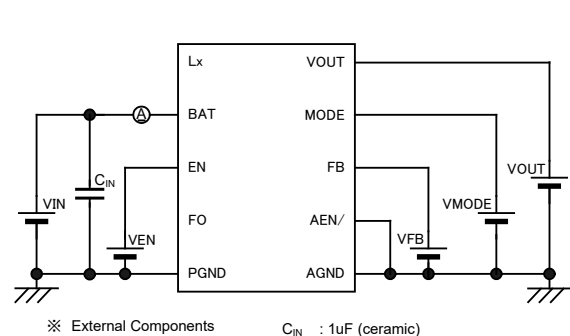

< Circuit No.4 >

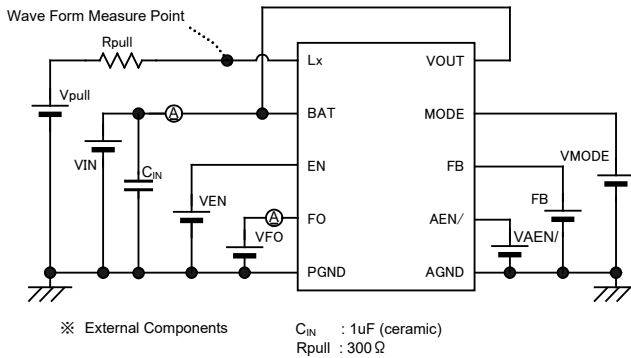

< Circuit No.5 >

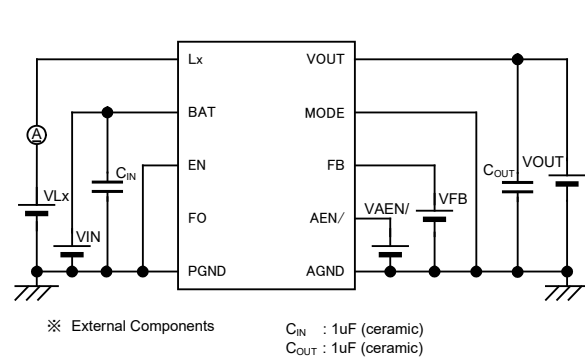

< Circuit No.6 >

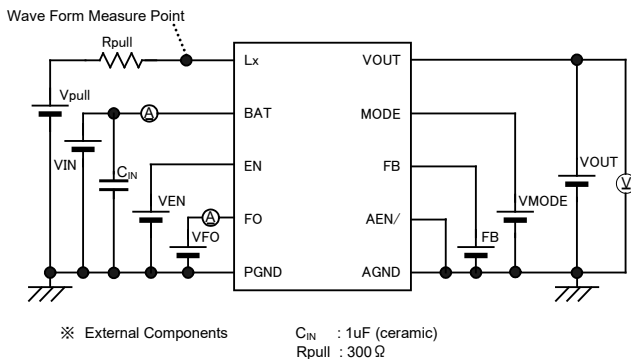

< Circuit No.7 >

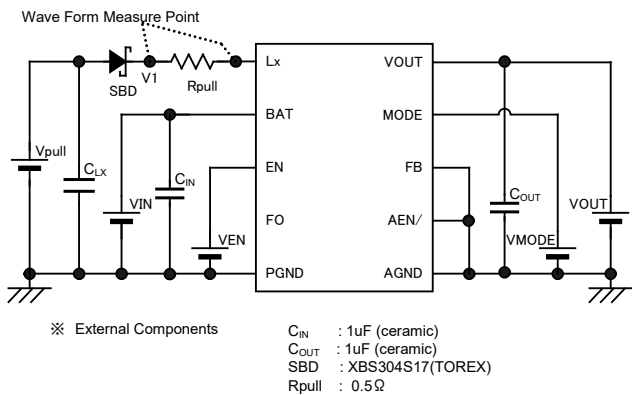

Measurement method for ON resistance of the Lx switch

Using the layout of circuit No.7 above, set the Lx pin voltage to 50mV by adjusting the Vpull voltage whilst the Nch driver transistor is turned on. Then, measure the voltage difference between both ends of Rpull. ON Resistance is calculated by using the following formula:

$$R_{LXN} = 0.05 \div ((V1 - 0.05) \div 0.5)$$

where V1 is a voltage between SBD and Rpull. Lx pin voltage and V1 are measured by an oscilloscope.

*1: The XC9129 series does not have the AEN/ pin and the FO pin. When the XC9129 series is measured, the FO and AEN pins are not effective in the above mentioned test circuits, they are NC.

TYPICAL PERFORMANCE CHARACTERISTICS

(1) Efficiency vs. Output Current

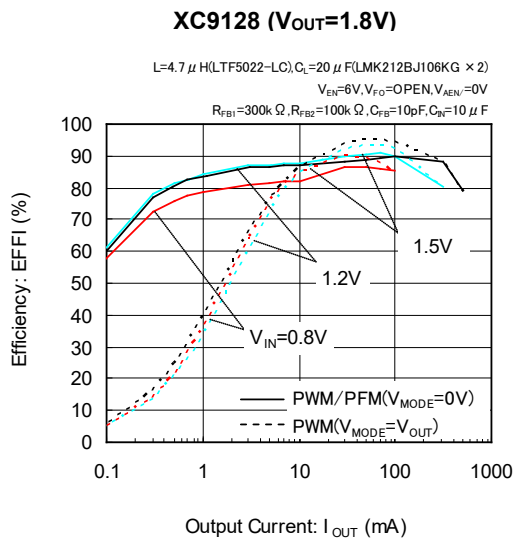
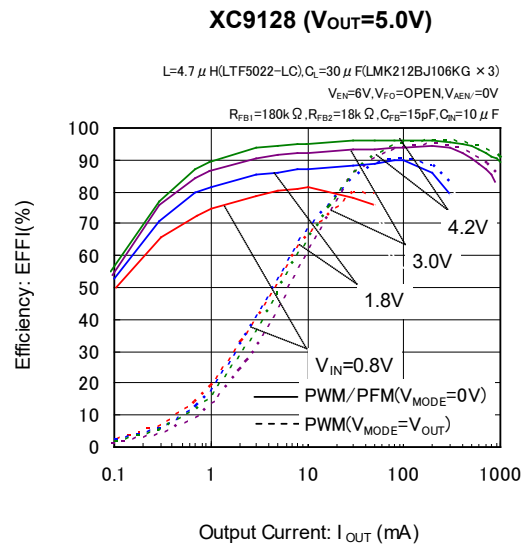
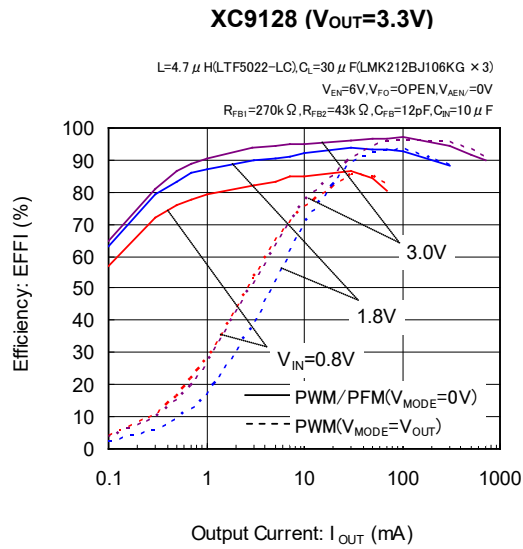

TYPICAL PERFORMANCE CHARACTERISTICS (Continued)

(2) Output Voltage vs. Output Current

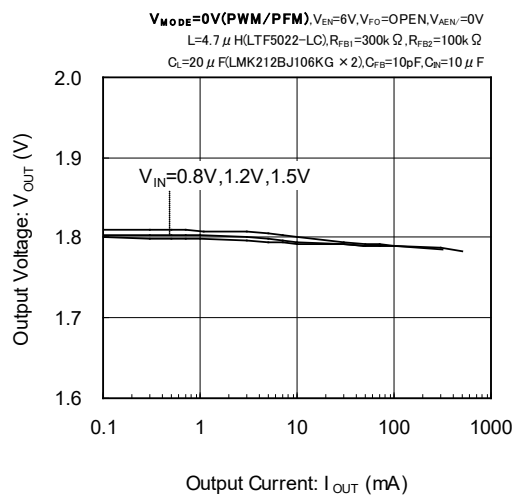
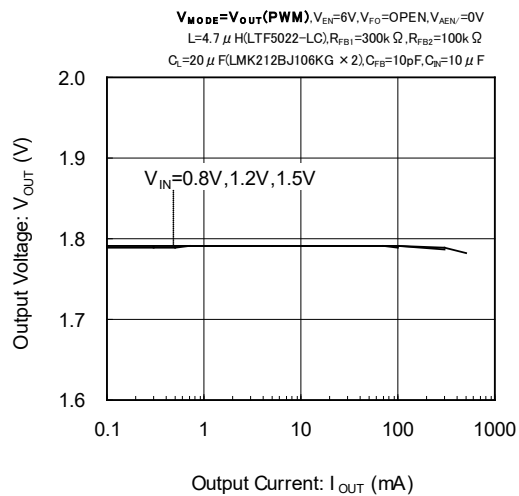
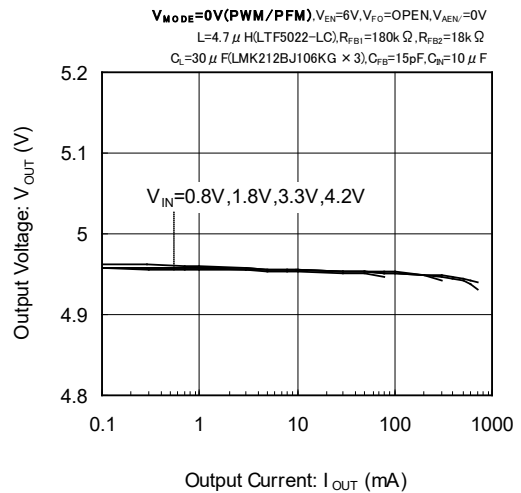
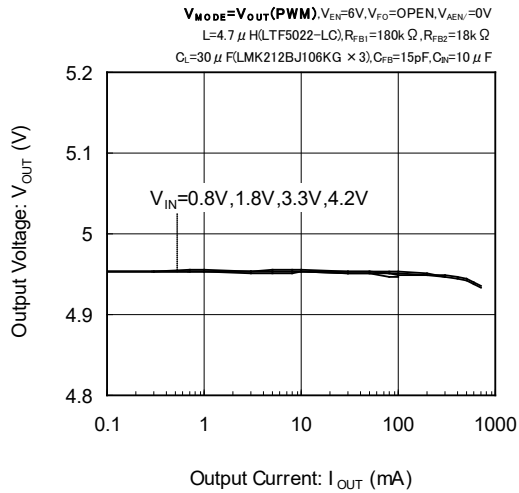
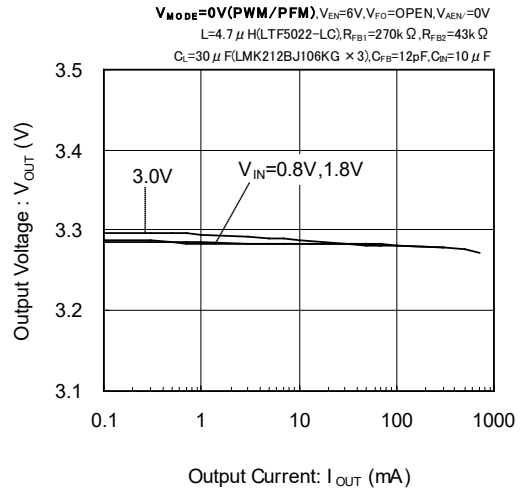
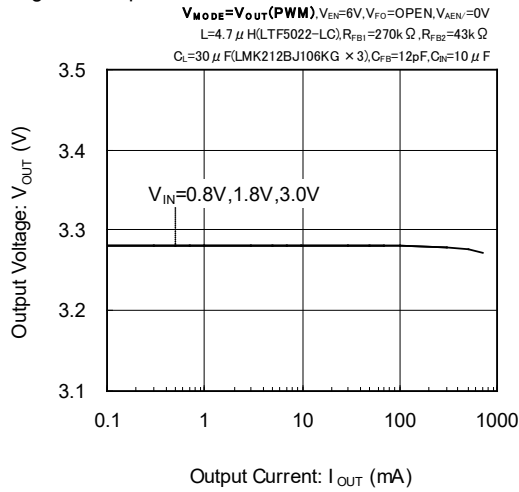

■ TYPICAL PERFORMANCE CHARACTERISTICS (Continued)

(3) Ripple Voltage vs. Output Current

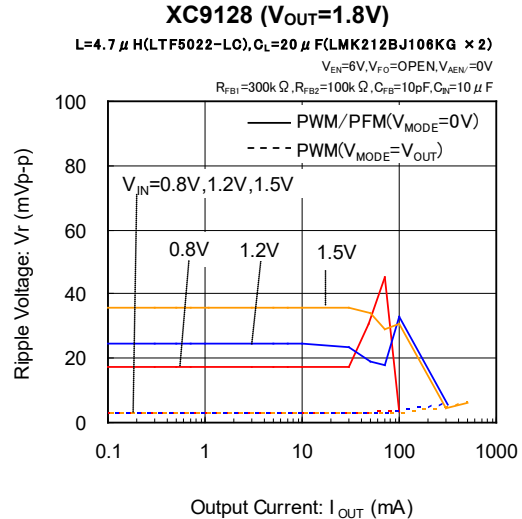
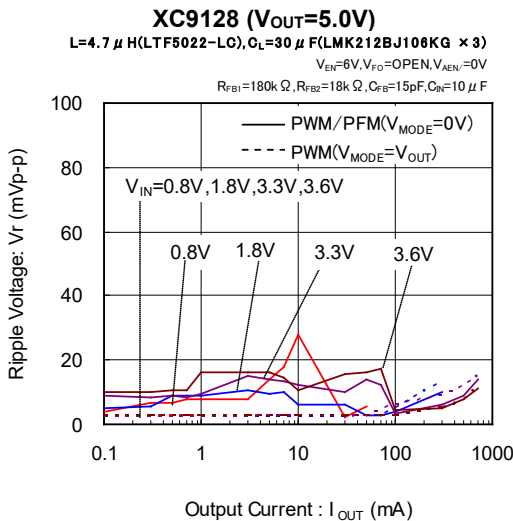
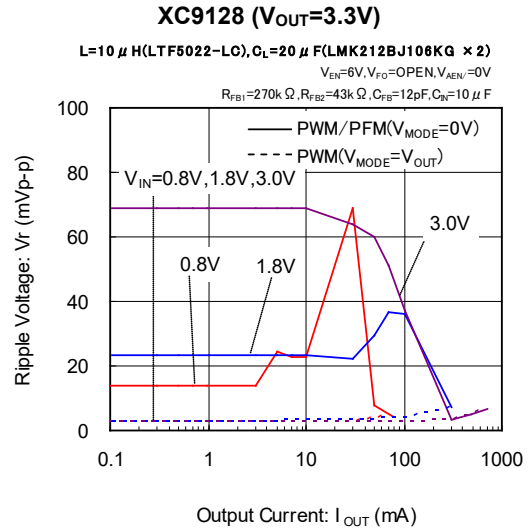
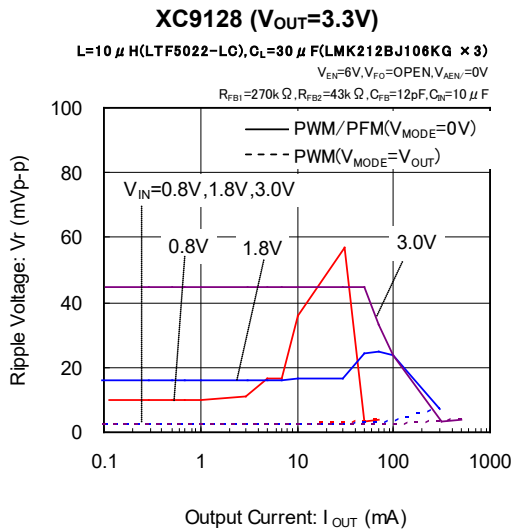
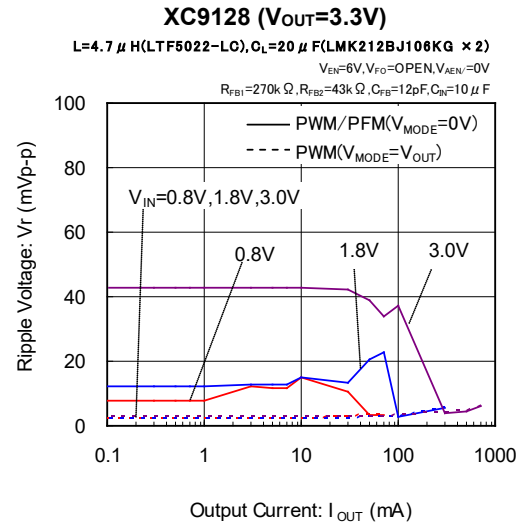
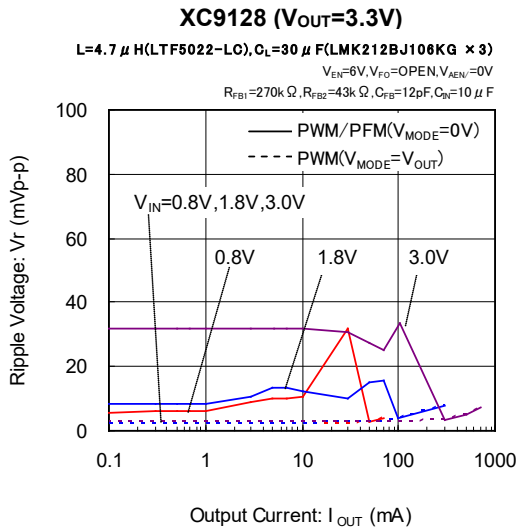

TYPICAL PERFORMANCE CHARACTERISTICS (Continued)

(4) Supply Current 1 vs. Ambient Temperature

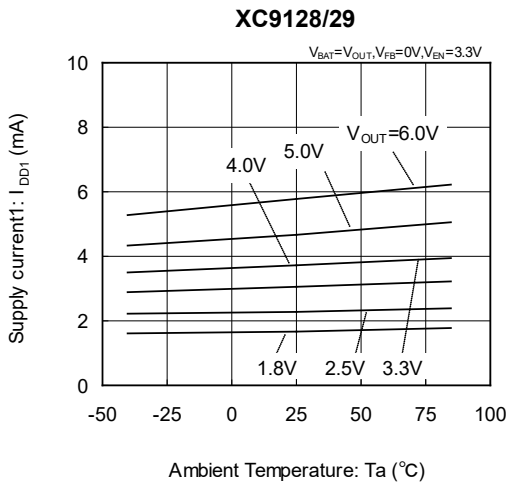

(5) Supply Current 1 vs. Output Voltage

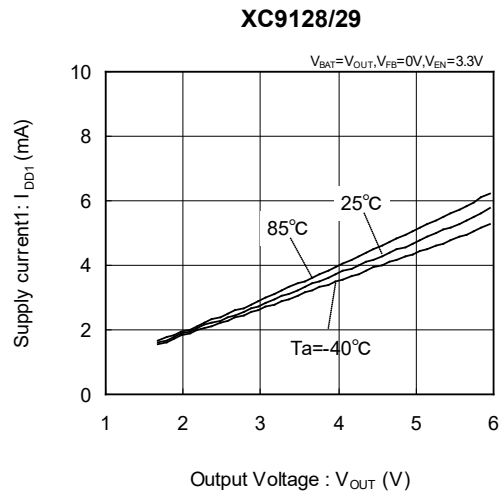

(6) Supply Current 2 vs. Ambient Temperature

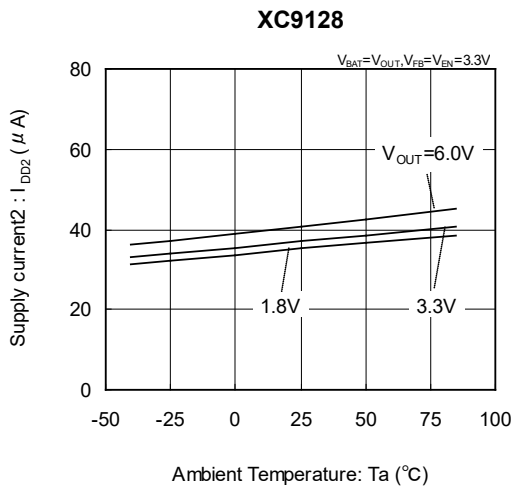

(7) Supply Current 2 vs. Output Voltage

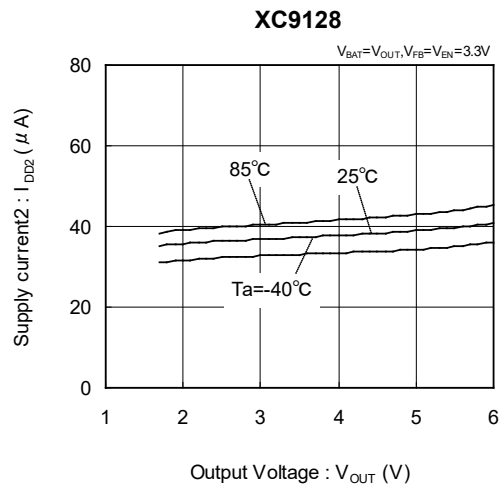

(8) Standby Current vs. Ambient Temperature

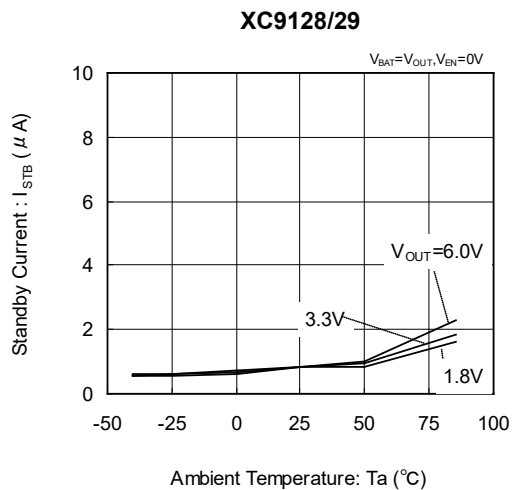

(9) Standby Current vs. Output Voltage

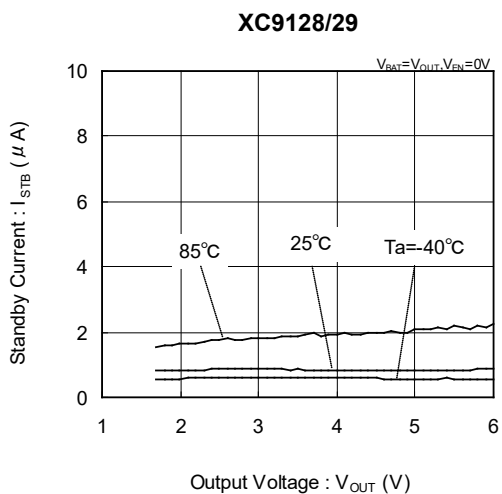

■ TYPICAL PERFORMANCE CHARACTERISTICS (Continued)

(10) FB Voltage vs. Ambient Temperature

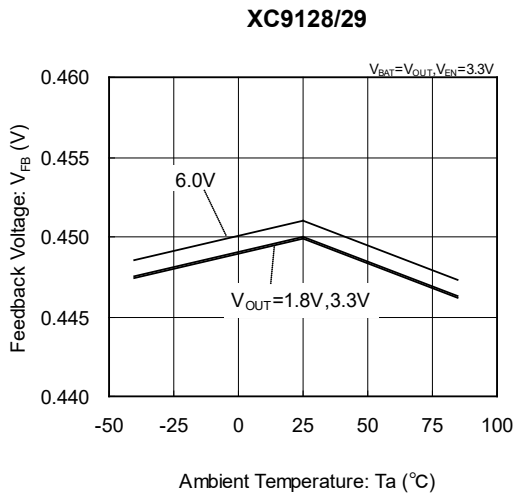

(11) FB Voltage vs. Output Voltage

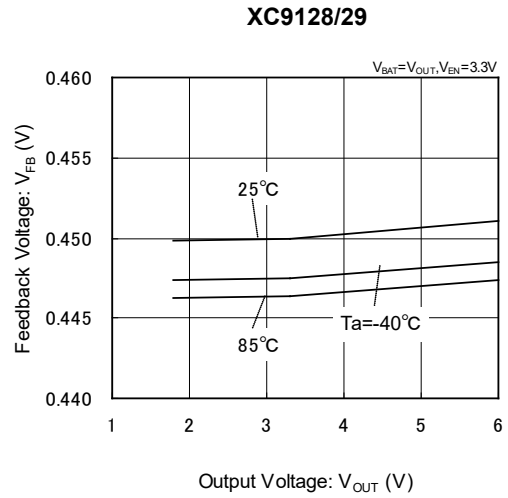

(12) Oscillation Frequency vs. Ambient Temperature

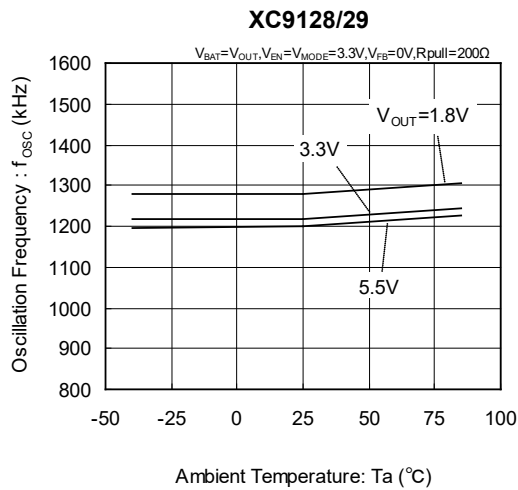

(13) Oscillation Frequency vs. Output Voltage

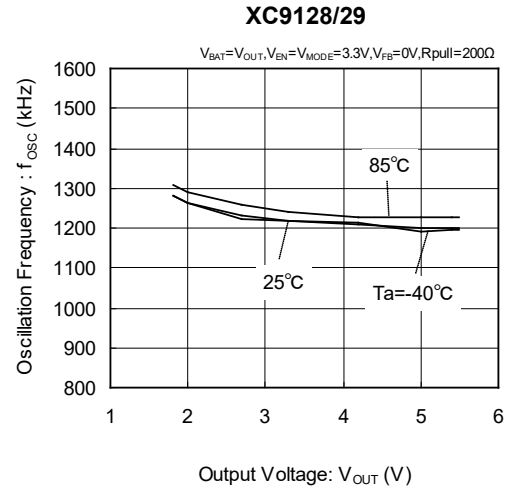

(14) Maximum Duty Cycle vs. Ambient Temperature

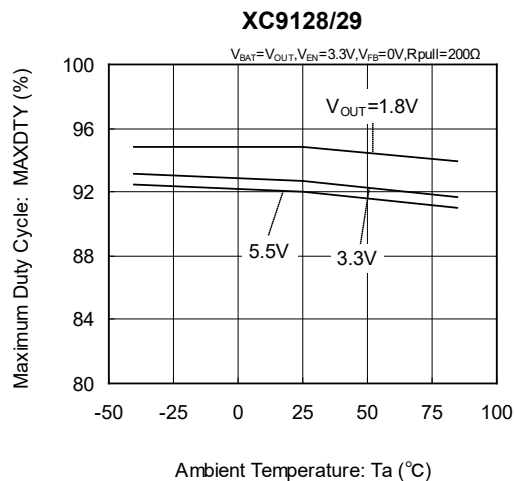

(15) Maximum Duty Cycle vs. Output Voltage

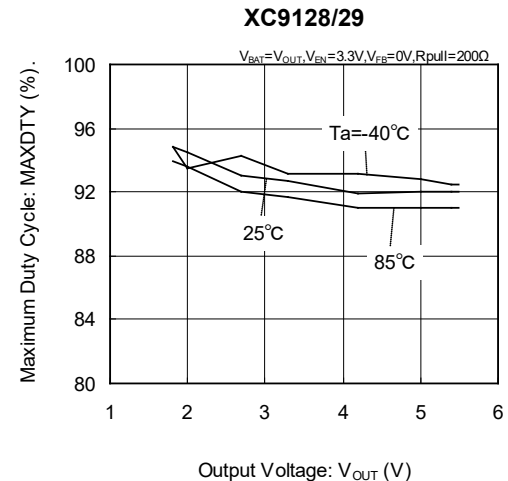

TYPICAL PERFORMANCE CHARACTERISTICS (Continued)

(16) PFM Switch Current vs. Ambient Temperature

XC9128 (V_{OUT}=5.0V)

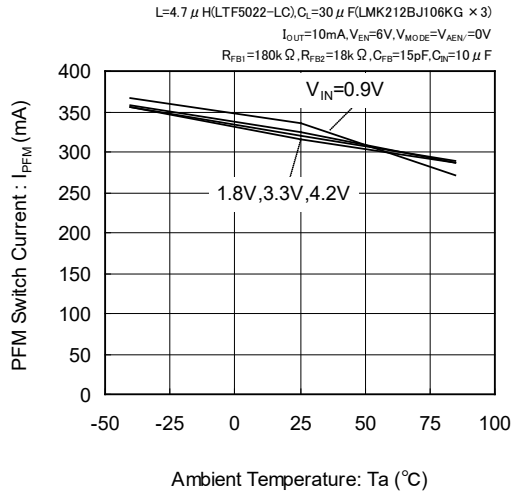

XC9128 (V_{OUT}=3.3V)

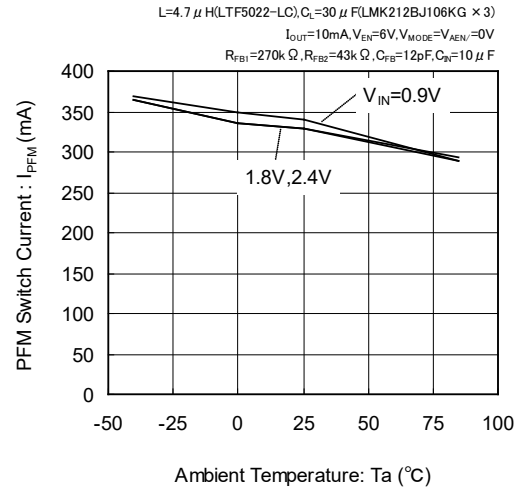

XC9128 (V_{OUT}=1.8V)

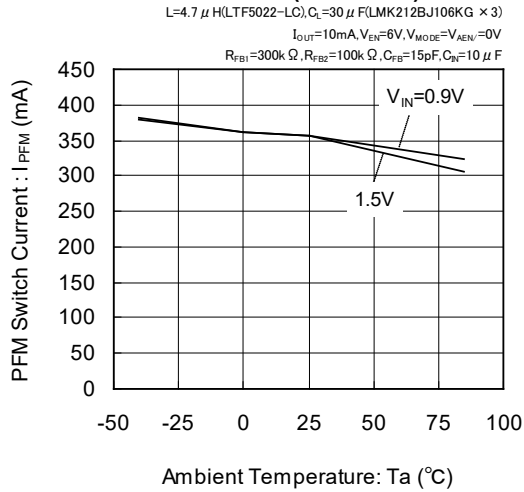

(17) PFM Switch Current vs. Output Voltage

XC9128 (V_{IN}=0.9V)

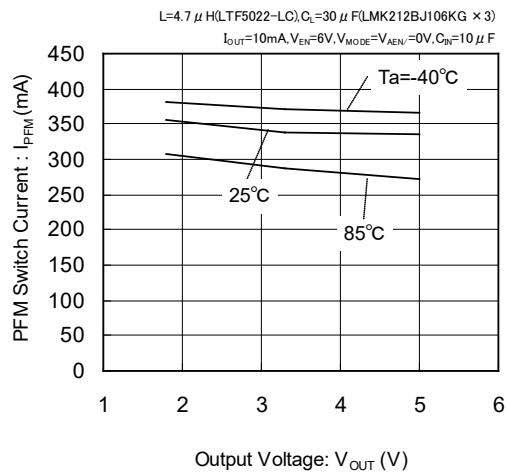

XC9128 (V_{IN}=1.5V)

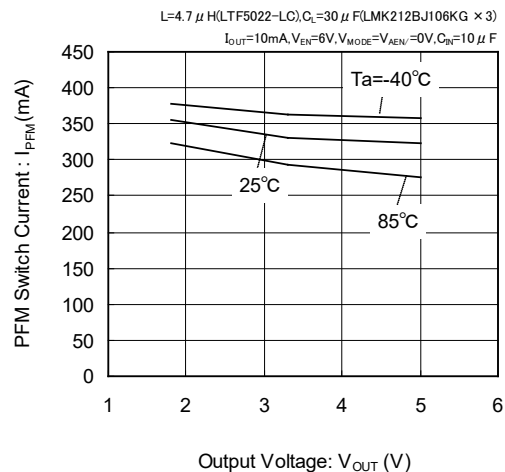

TYPICAL PERFORMANCE CHARACTERISTICS (Continued)

(18) Limit Current vs. Ambient Temperature

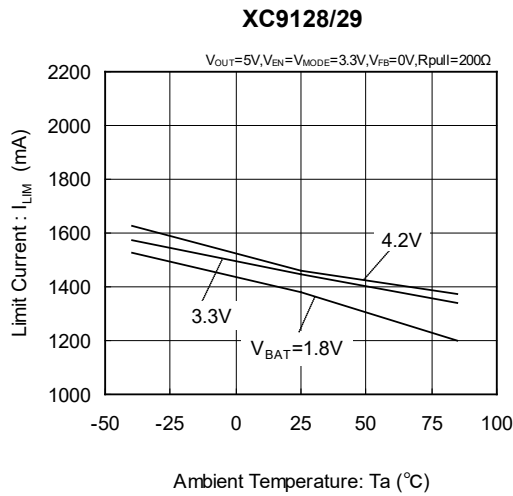

(19) Limit Current vs. Output Voltage

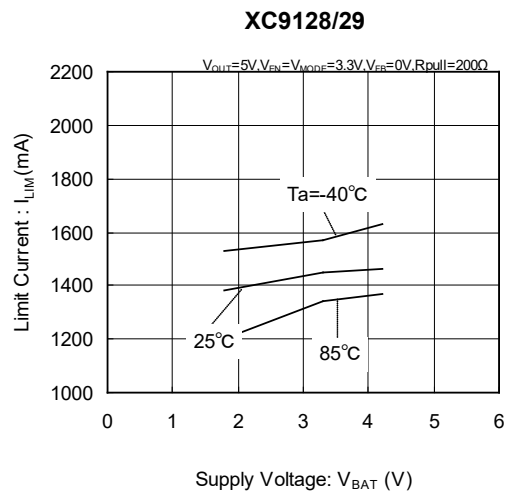

(20) Lx SW "Pch" ON Resistance vs. Ambient Temperature

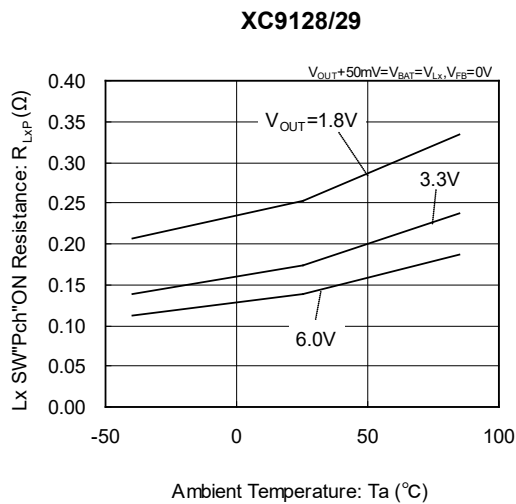

(21) Lx SW "Pch" ON Resistance vs. Output Voltage

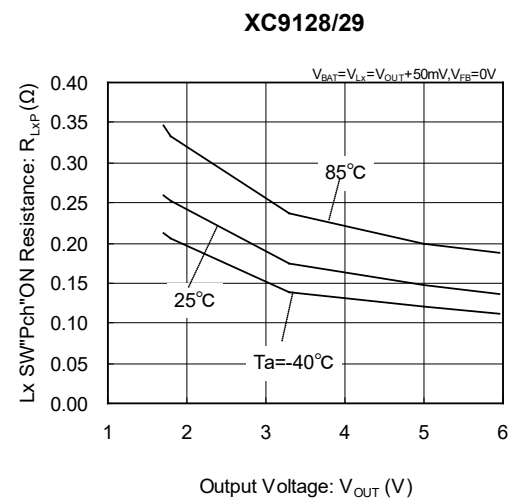

(22) Lx SW "Nch" ON Resistance vs. Ambient Temperature

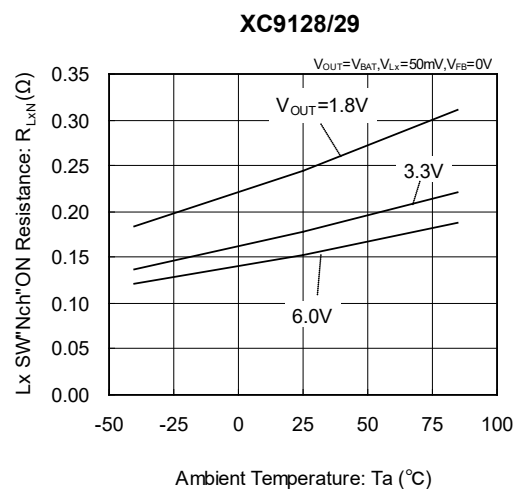

(23) Lx SW "Nch" ON Resistance vs. Output Voltage

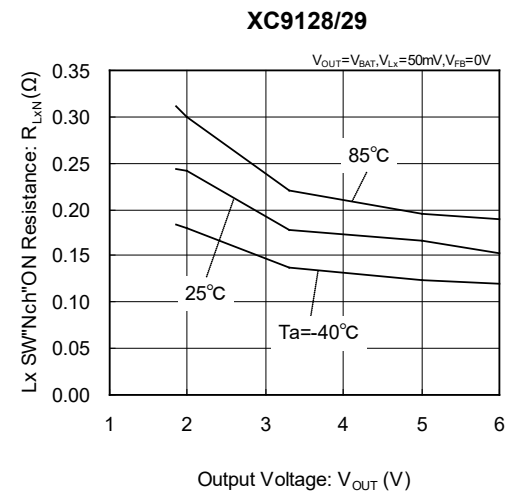

TYPICAL PERFORMANCE CHARACTERISTICS (Continued)

(24) Soft Start Time 1 vs. Ambient Temperature

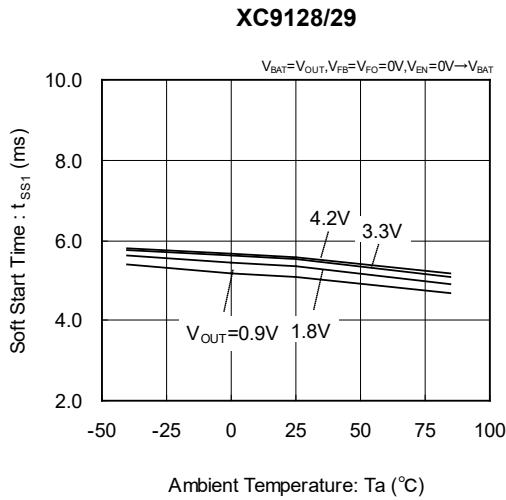

(25) Soft Start Time 1 vs. Output Voltage

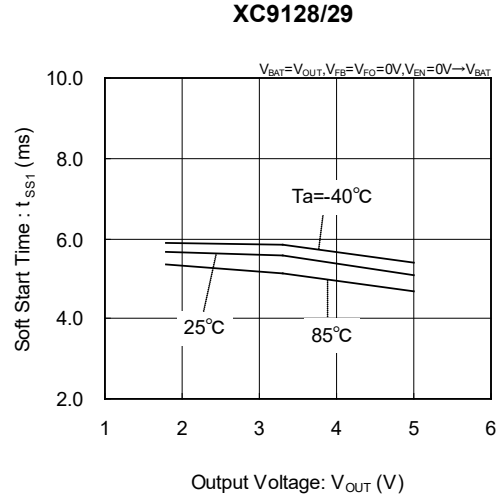

(26) Flag Output Current vs. Ambient Temperature

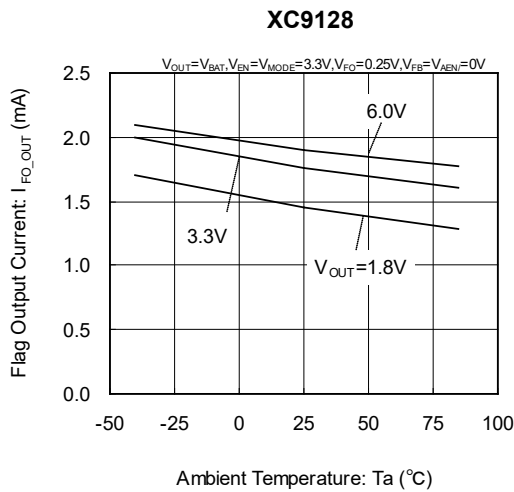

(27) Flag Output Current vs. Output Voltage

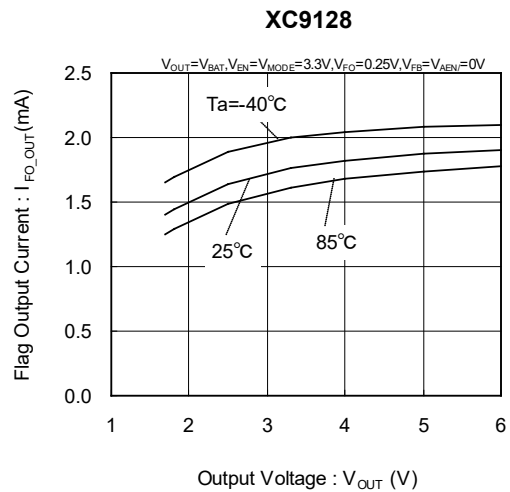

(28) Flag Leakage Current vs. Ambient Temperature

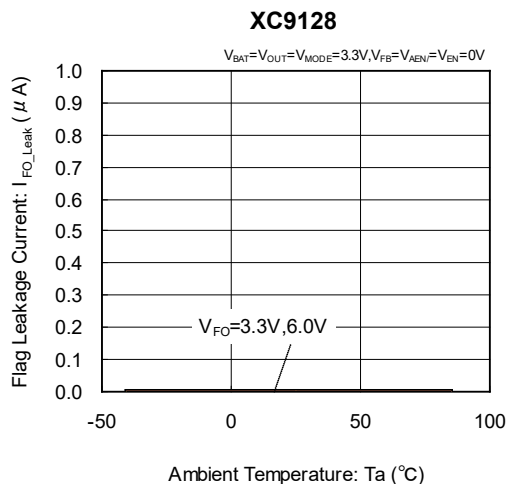

(29) Flag Leakage Current vs. Output Current

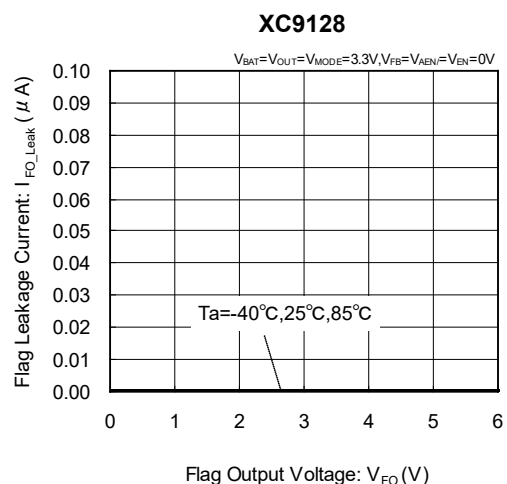

TYPICAL PERFORMANCE CHARACTERISTICS (Continued)

(30) Low Voltage Protection Voltage vs. Ambient Temperature

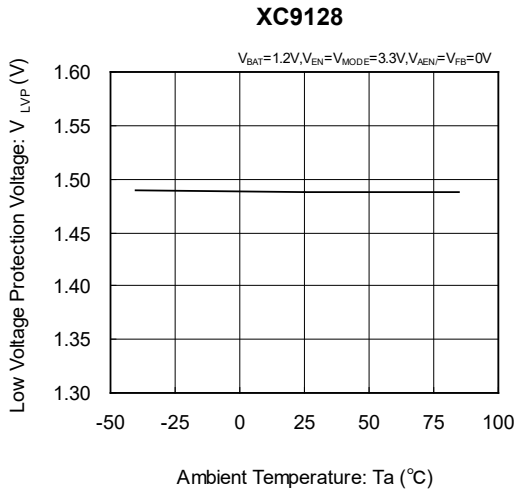

(31) EN "H" Voltage vs. Ambient Temperature

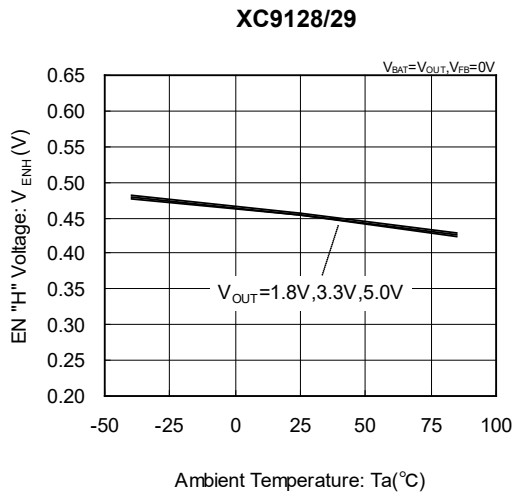

(32) EN "H" Voltage vs. Output Voltage

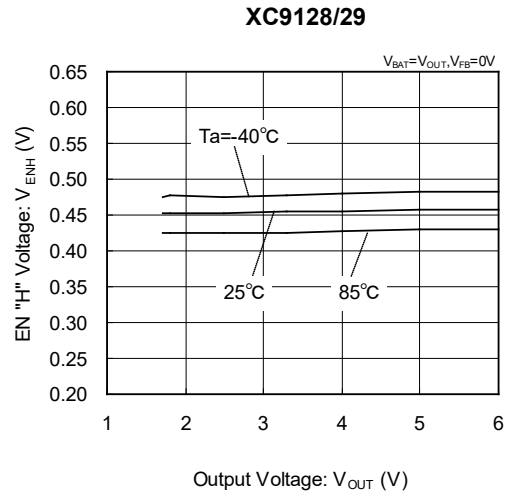

(33) EN "L" Voltage vs. Ambient Temperature

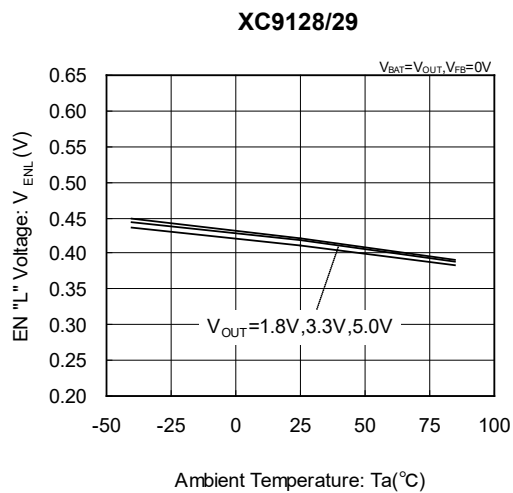

(34) EN "L" Voltage vs. Output Voltage

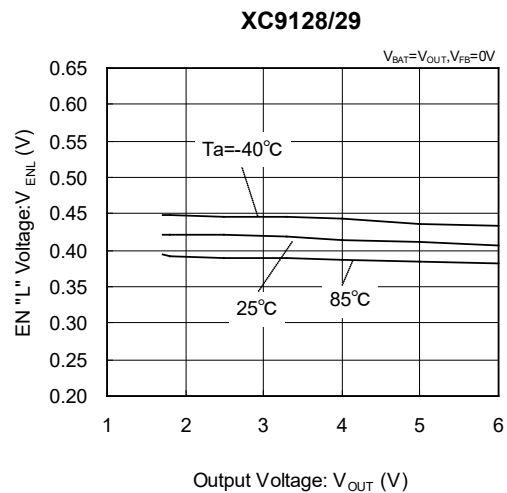

TYPICAL PERFORMANCE CHARACTERISTICS (Continued)

(35) MODE "H" Voltage vs. Ambient Temperature

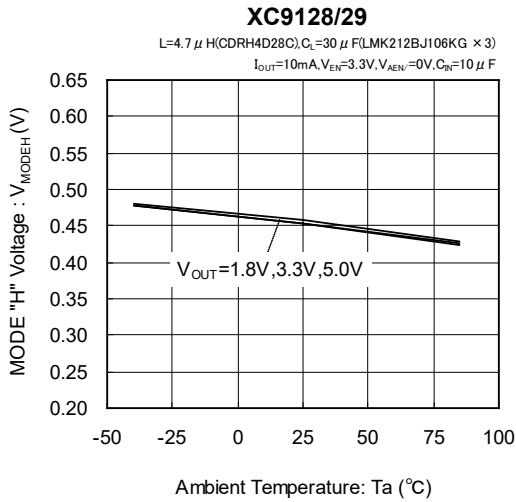

(36) MODE "H" Voltage vs. Output Voltage

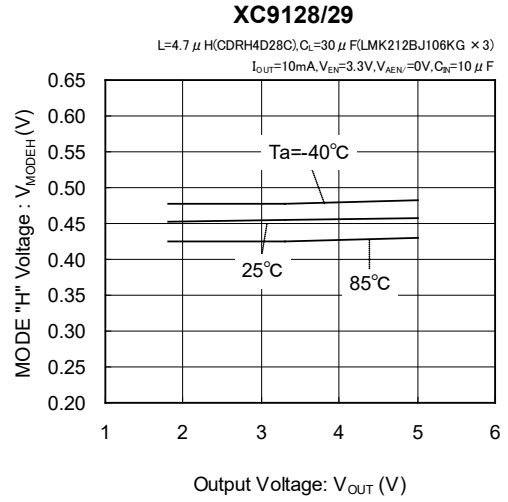

(37) MODE "L" Voltage vs. Ambient Temperature

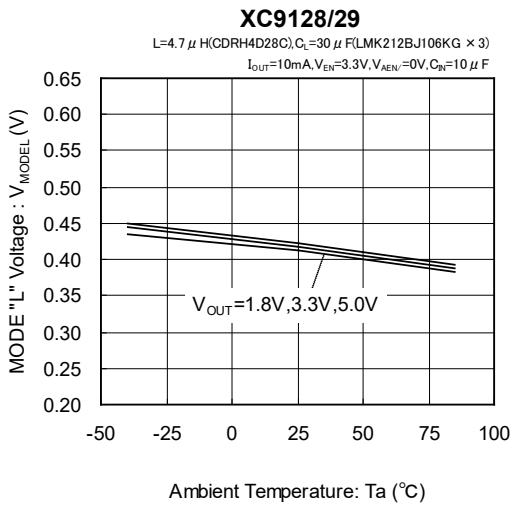

(38) MODE "L" Voltage vs. Output Voltage

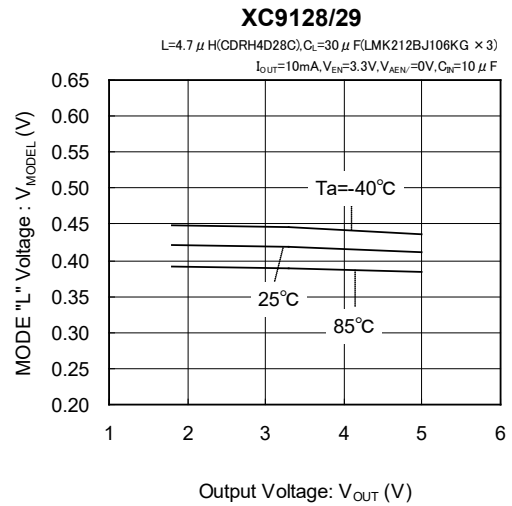

(39) AEN/Voltage vs. Ambient Temperature

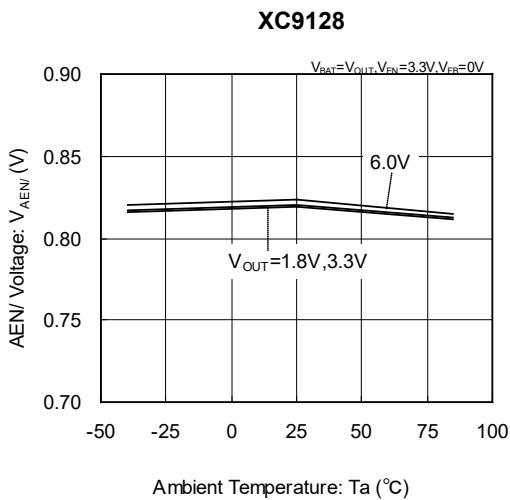

(40) AEN/Voltage vs. Output Voltage

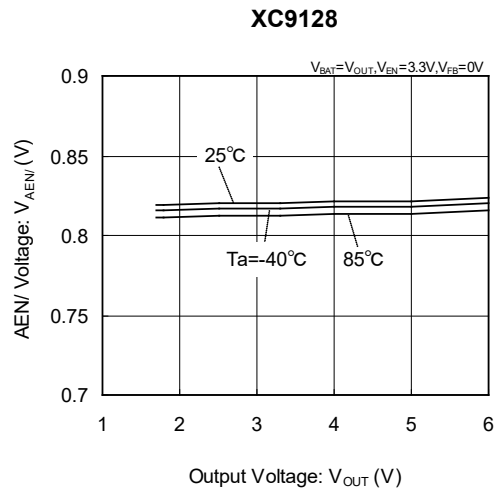

TYPICAL PERFORMANCE CHARACTERISTICS (Continued)

(41) Load Transient Response

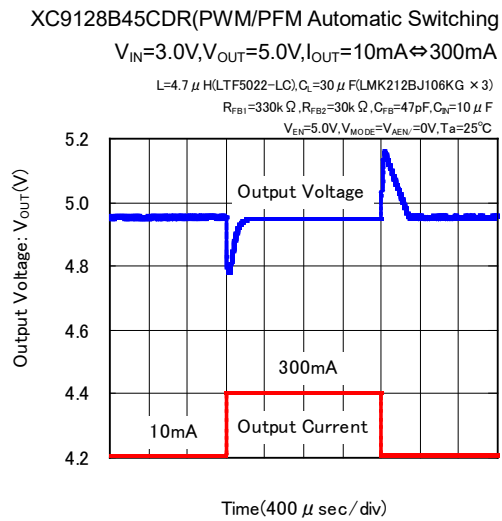
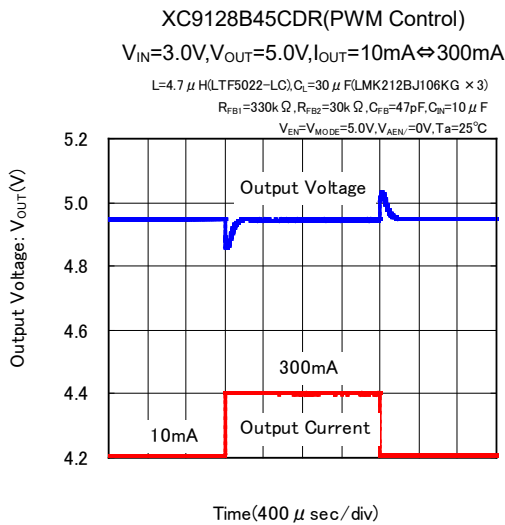
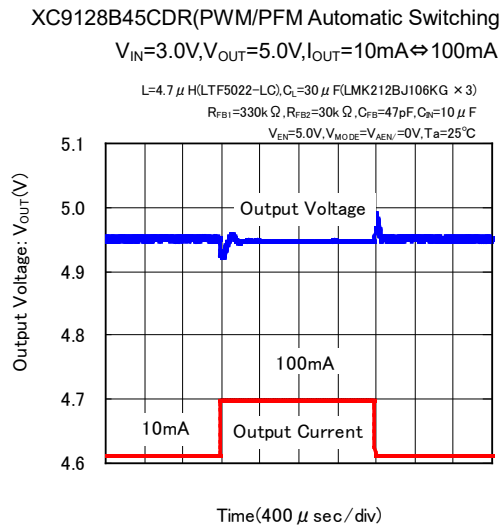
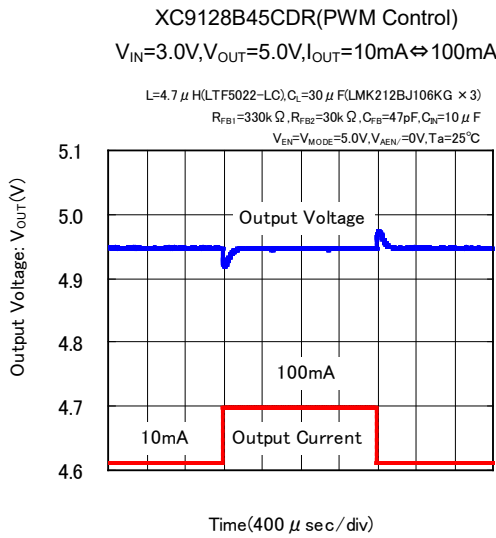
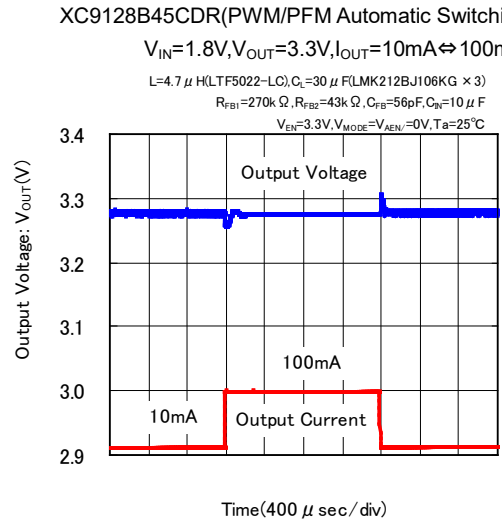
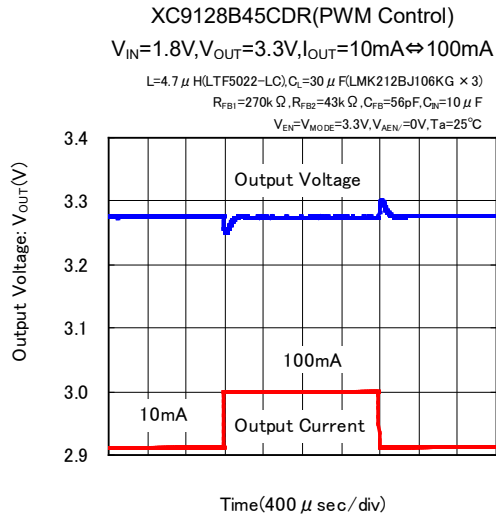

■ PACKAGING INFORMATION

For the latest package information go to, www.torexsemi.com/technical-support/packages

PACKAGE	OUTLINE / LAND PATTERN	THERMAL CHARACTERISTICS	
MSOP-10	MSOP-10 PKG	Standard Board	MSOP-10 Power Dissipation
USP-10B	USP-10B PKG	Standard Board	USP-10B Power Dissipation

MARKING RULE

● USP-10B

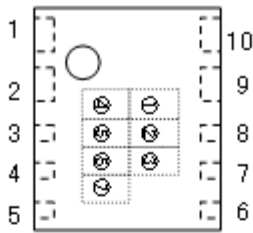

● MSOP-10

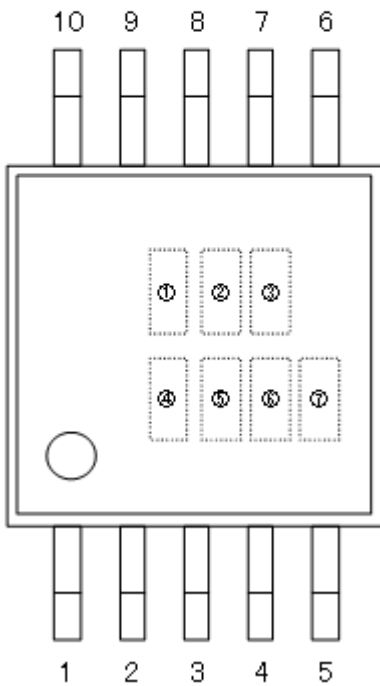

① represents product series.

MARK	PRODUCT SERIES
8	XC9128 series
9	XC9129 series

② represents transistor built-in, output voltage freely set (FB voltage), integral protection type.

MARK	PRODUCT SERIES
B	With integral protection
D	Without integral protection

③④ represents reference voltage.

MARK		VOLTAGE(V)
③	④	
4	5	0.45

⑤ represents oscillation frequency.

MARK	OSCILLATION FREQUENCY(kHz)
C	1200

⑥⑦ represents production lot number

01 to 09, 10 to 99, 0A~ 0Z, 1A ~9Z,A0~Z9,AA~ZZ in order.
(G, I, J, O, Q, W excluded)

*No character inversion used

1. The product and product specifications contained herein are subject to change without notice to improve performance characteristics. Consult us, or our representatives before use, to confirm that the information in this datasheet is up to date.
2. The information in this datasheet is intended to illustrate the operation and characteristics of our products. We neither make warranties or representations with respect to the accuracy or completeness of the information contained in this datasheet nor grant any license to any intellectual property rights of ours or any third party concerning with the information in this datasheet.
3. Applicable export control laws and regulations should be complied and the procedures required by such laws and regulations should also be followed, when the product or any information contained in this datasheet is exported.
4. The product is neither intended nor warranted for use in equipment of systems which require extremely high levels of quality and/or reliability and/or a malfunction or failure which may cause loss of human life, bodily injury, serious property damage including but not limited to devices or equipment used in 1) nuclear facilities, 2) aerospace industry, 3) medical facilities, 4) automobile industry and other transportation industry and 5) safety devices and safety equipment to control combustions and explosions. Do not use the product for the above use unless agreed by us in writing in advance.
5. Although we make continuous efforts to improve the quality and reliability of our products; nevertheless Semiconductors are likely to fail with a certain probability. So in order to prevent personal injury and/or property damage resulting from such failure, customers are required to incorporate adequate safety measures in their designs, such as system fail safes, redundancy and fire prevention features.
6. Our products are not designed to be Radiation-resistant.
7. Please use the product listed in this datasheet within the specified ranges.
8. We assume no responsibility for damage or loss due to abnormal use.
9. All rights reserved. No part of this datasheet may be copied or reproduced unless agreed by Torex Semiconductor Ltd in writing in advance.

TOREX SEMICONDUCTOR LTD.

X-ON Electronics

Largest Supplier of Electrical and Electronic Components

Click to view similar products for [Switching Voltage Regulators](#) category:

Click to view products by [Torex Semiconductor](#) manufacturer:

Other Similar products are found below :

[FAN53610AUC33X](#) [FAN53611AUC123X](#) [FAN48610BUC33X](#) [FAN48610BUC45X](#) [FAN48617UC50X](#) [R3](#) [430464BB](#) [KE177614](#)
[FAN53611AUC12X](#) [MAX809TTR](#) [NCV891234MW50R2G](#) [NCP81103MNTXG](#) [NCP81203PMNTXG](#) [NCP81208MNTXG](#)
[NCP81109GMNTXG](#) [SCY1751FCCT1G](#) [NCP81109JMNTXG](#) [AP3409ADNTR-G1](#) [NCP81241MNTXG](#) [LTM8064IY](#) [LT8315EFE#TRPBF](#)
[LTM4664EY#PBF](#) [LTM4668AIY#PBF](#) [NCV1077CSTBT3G](#) [XCL207A123CR-G](#) [MPM54304GMN-0002](#) [MPM54304GMN-0004](#)
[MPM54304GMN-0003](#) [AP62300Z6-7](#) [MP8757GL-P](#) [MIC23356YFT-TR](#) [LD8116CGL](#) [HG2269M/TR](#) [OB2269](#) [XD3526](#) [U6215A](#) [U6215B](#)
[U6620S](#) [LTC3412IFE](#) [LT1425IS](#) [MAX25203BATJA/VY+](#) [MAX77874CEWM+](#) [XC9236D08CER-G](#) [MP3416GJ-P](#) [BD9S201NUX-CE2](#)
[MP5461GC-Z](#) [MPQ4415AGQB-Z](#) [MPQ4590GS-Z](#) [MAX38640BENT18+T](#) [MAX77511AEWB+](#)