

Voltage Regulator with Bridge Diode for Wireless Power Receiver

■ GENERAL DESCRIPTION

The XCM414 series consist of four Schottky Barrier Diodes (SBD) and a positive voltage regulator (VR).

These four SBDs configure a bridge circuit and it performs the full-wave rectification of an AC input so that the positive voltage regulator can generate DC output.

The VR consists of a voltage reference, an error amplifier, a current limiter, a thermal shutdown circuit and a phase compensation circuit plus a driver transistor. The output voltage is preset at 3.3V in the IC as a standard value, and it is selectable in 0.1V increments within the range of 2.0V to 12V using laser trimming technologies. The output stabilization capacitor (CL) is also compatible with low ESR ceramic capacitors.

The over current protection circuit and the thermal shutdown circuit are built-in. These two protection circuits will operate when the output current reaches current limit level or the junction temperature reaches temperature limit level.

The CE function enables the output to be turned off and the IC becomes a stand-by mode resulting in greatly reduced power consumption.

■ APPLICATIONS

- Smart Card
- Hearing Aid
- Wireless earphone/
Bluetooth earphone
- Wearable Devices
- Wireless Charger Devices

■ FEATURES

Schottky Barrier Diode (SBD)

Forward Voltage	: 0.33V ($I_F=10\text{mA}$)
Reverse Current	: $2\mu\text{A}$ ($V_R=40\text{V}$)

Voltage Regulator (VR)

Input Voltage Range	: 2.0V ~ 26.0V
Output Voltage Range	: 2.0V ~ 12.0V(0.1V increments)
Fixed Output Accuracy	: $\pm 2.0\%$
Low Power Consumption	: $5\mu\text{A}$
Stand-by Current	: less than $0.1\mu\text{A}$
High Ripple Rejection	: 30dB@1kHz
Low ESR Capacitor	: Ceramic Capacitor Compatible
Built-in Protection	: Current Limit Circuit : Thermal Shutdown Circuit
Operating Temperature	: $-40^\circ\text{C} \sim 85^\circ\text{C}$
Packages	: USP-8B10
Environmentally Friendly	: EU RoHS Compliant, Pb Free

■ TYPICAL APPLICATION CIRCUIT

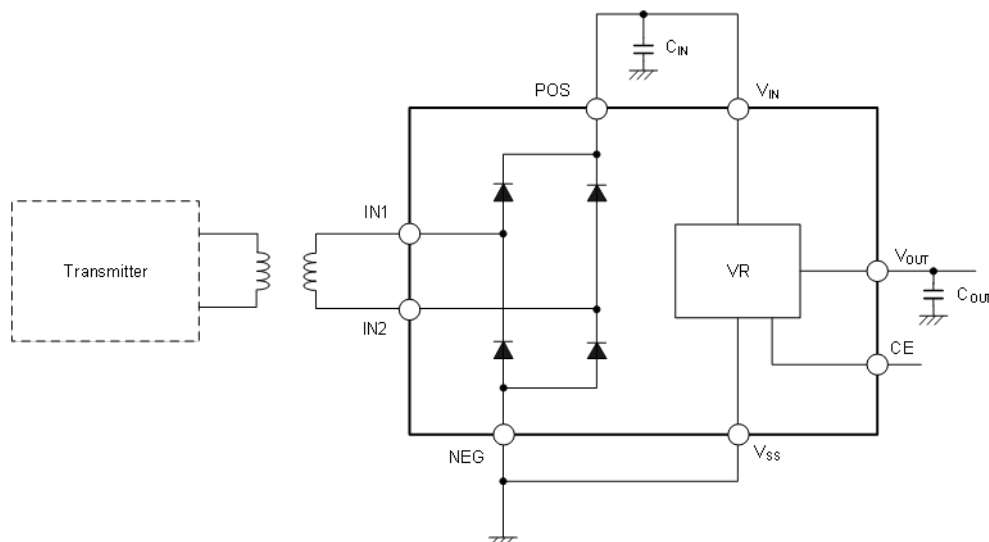

PIN CONFIGURATION

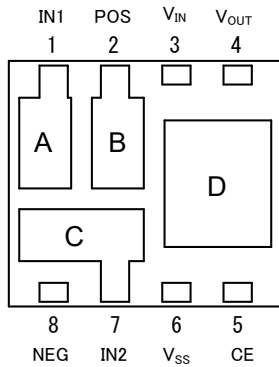

USP-8B10
(BOTTOM VIEW)

* The dissipation pad should be solder-plated in reference to the mount pattern and metal masking so as to enhance mounting strength and heat release. Connect mount pattern D with V_{SS} pin (#6 pin) but don't connect the mount pattern A, B, and C to other pins, because they are connected with each SBD.

FUNCTION

PIN NAME	DESIGNATOR	CONDITIONS	IC OPERATION
CE	L	$0V \leq V_{CE} \leq 0.35V$	OFF
	H	$1.1V \leq V_{CE} \leq 26.0V$	ON
	OPEN	CE=OPEN	Undefined state

*Please avoid the state of OPEN, and make CE Pin arbitrary fixed potential.

PIN ASSIGNMENT

PIN NUMBER	PIN NAME	FUNCTION
USP-8B10		
1	IN1	Bridge Input 1
2	POS	Bridge Positive
3	V_{IN}	Voltage Regulator Input Power
4	V_{OUT}	Voltage Regulator Output
5	CE	ON/OFF Control ^(*)
6	V_{SS}	Voltage Regulator Ground
7	IN2	Bridge Input2
8	NEG	Bridge Negative

^(*) Please avoid the state of OPEN, and make CE Pin arbitrary fixed potential.

PRODUCT CLASSIFICATION

Ordering Information

XCM414①②③④⑤⑥-⑦ ^(*)

DESIGNATOR	DESCRIPTION	SYMBOL	DESCRIPTION
①	TYPE	B	Fixed
②③④	Output Voltage	020 ~ 120	For the voltage within 2.0V ~ 12.0V (0.1V increments) e.g. 033 \Rightarrow 3.3V, 105 \Rightarrow 10.5V
⑤⑥-⑦	Packages Taping Type	D2-G	USP-8B10 (5,000 pcs/Reel)

^(*) The "-G" suffix denotes Halogen and Antimony free as well as being fully EU RoHS compliant.

■ BLOCK DIGRAMS

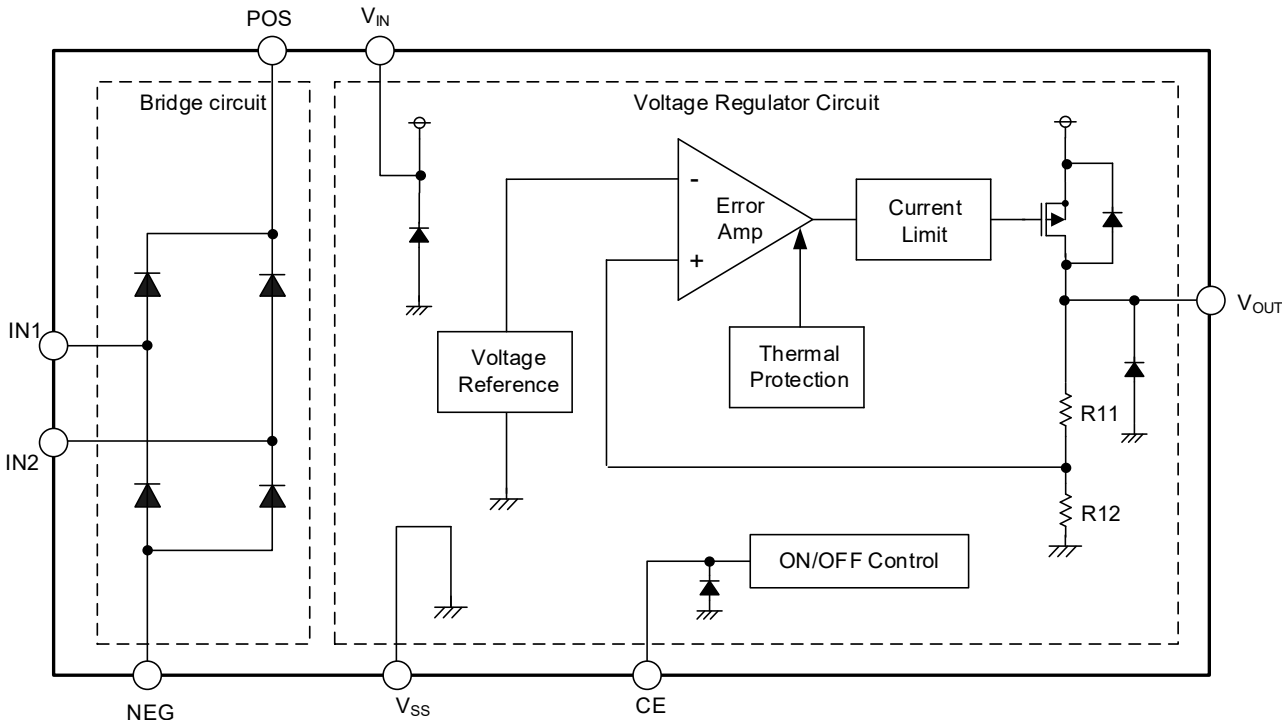

* The diode in the bridge circuit in the above figure is a Schottky barrier diode.
The diode of the voltage regulator circuit is a diode for electrostatic protection and a parasitic diode.

■ ABSOLUTE MAXIMUM RATINGS

PARAMETER	SYMBOL	RATINGS	UNITS
● Schottky Barrier Diode (SBD)			
Repetitive Peak Voltage	V_{RM}	40	V
Reverse Voltage (DC)	V_R	40	V
Forward Current (Average)	$I_{F(AV)}$	200	mA
Peak Forward Surge Current ⁽¹⁾	I_{FSM}	1	A
● Voltage Regulator (VR) ⁽²⁾			
Input Voltage	V_{IN}	$V_{SS} - 0.3 \sim 28$	V
Output Voltage	V_{OUT}	$V_{SS} - 0.3 \sim V_{IN} + 0.3$	V
CE Input Voltage	V_{CE}	$V_{SS} - 0.3 \sim 28$	V
● Common			
Power Dissipation ($T_a=25^\circ\text{C}$)	USP-8B10	P_d	1400 (High heat dissipation board) ⁽³⁾
Operating Ambient Temperature		T_{opr}	$-40 \sim 85$
Storage Temperature		T_{stg}	$-55 \sim 125$

⁽¹⁾ Non continuous 1 cycle high amplitude 60Hz half-sine wave.
⁽²⁾ Voltage Regulator voltage rating is based on V_{SS}
⁽³⁾ The power dissipation figure shown is PCB mounted and is for reference only.
 The mounting condition is please refer to PACKAGING INFORMATION.

■ ELECTRICAL CHARACTERISTICS

● Schottky Barrier Diode (SBD)

Ta=25°C

PARAMETER	STMBOL	TEST CONDITION	MIN.	TYP.	MAX.	UNITS
Forward Voltage	VF1	$I_F=10\text{mA}$	-	0.33	-	V
	VF2	$I_F=200\text{mA}$	-	0.53	0.6	V
Reverse Current	IR	$V_R=40\text{V}$	-	-	2	μA
Inter-Terminal Capacity	Ct	$V_R=10\text{V}, f=1\text{MHz}$	-	10	-	pF
Reverse Recovery Time ^(*)	trr	$I_F=I_R=10\text{mA}, i_{rr}=1\text{mA}$	-	6	-	ns

(*) trr measurement circuit

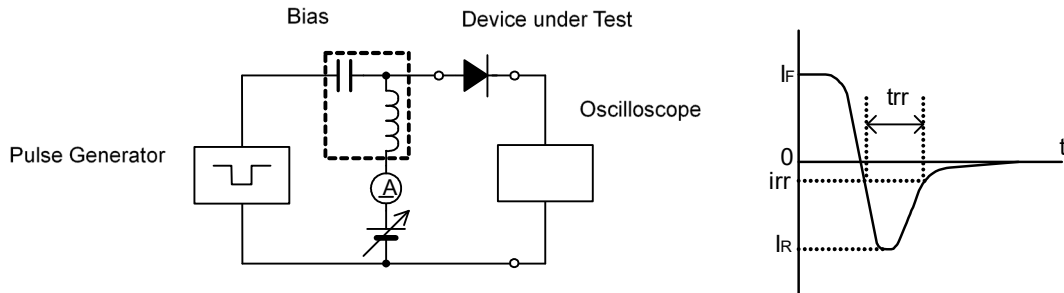

■ ELECTRICAL CHARACTERISTICS (Continued)

● Voltage Regulator (VR)

Ta=25°C

PARAMETER	STMBOL	TEST CONDITION	MIN.	TYP.	MAX.	UNITS	CIRCUIT
Output Voltage	V _{OUT(E)} ⁽²⁾	I _{OUT} =20mA, V _{CE} =V _{IN}	E-0			V	①
Maximum Output Current	I _{OUTMAX}	V _{IN} =V _{OUT(T)} ⁽¹⁾ +3.0V, V _{CE} =V _{IN} (V _{OUT(T)} ≥3.0V)	150	-	-	mA	①
		V _{IN} =V _{OUT(T)} ⁽¹⁾ +3.0V, V _{CE} =V _{IN} (V _{OUT(T)} <3.0V)	100	-	-	mA	①
Load Regulation	ΔV _{OUT}	1mA≤I _{OUT} ≤50mA, V _{CE} =V _{IN} (2.0V≤V _{OUT(T)} ⁽¹⁾ ≤7.0V)	-	50	90	mV	①
		1mA≤I _{OUT} ≤50mA, V _{CE} =V _{IN} (7.0V<V _{OUT(T)} ⁽¹⁾ ≤12.0V)	-	110	140	mV	①
Dropout Voltage 1	V _{dif1} ⁽³⁾	I _{OUT} =20mA, V _{CE} =V _{IN}	-	E-1		mV	①
Dropout Voltage 2	V _{dif2} ⁽³⁾	I _{OUT} =100mA, V _{CE} =V _{IN}	-	E-2		mV	①
Supply Current	I _{SS}	V _{CE} =V _{IN}	1	5	9	μA	②
Stand-by Current	I _{STB}	V _{CE} =V _{SS}	-	0.01	0.1	μA	②
Line Regulation 1	ΔV _{OUT} / (ΔV _{IN} · V _{OUT})	V _{OUT(T)} ⁽¹⁾ +2.0V≤V _{IN} ≤26.0V I _{OUT} =5mA, V _{CE} =V _{IN}	-	0.05	0.10	%/V	①
Line Regulation 2	ΔV _{OUT} / (ΔV _{IN} · V _{OUT})	V _{OUT(T)} ⁽¹⁾ +2.0V≤V _{IN} ≤26.0V I _{OUT} =13mA, V _{CE} =V _{IN}	-	0.15	0.30	%/V	①
Input Voltage	V _{IN}		2.0	-	26.0	V	-
Output Voltage Temperature Characteristics	ΔV _{OUT} / (ΔT _{opr} · V _{OUT})	I _{OUT} =20mA, V _{CE} =V _{IN} -40°C≤T _{opr} ≤85°C	-	±100	-	ppm/°C	①
Power Supply Rejection Ratio	PSRR	V _{IN} =[V _{OUT(T)} ⁽¹⁾ +2.0]V +0.5Vp-pAC I _{OUT} =20mA, f=1kHz, V _{CE} =V _{IN}	-	30	-	dB	③
Short Current	I _{SHORT}	V _{CE} =V _{IN}	-	30	-	mA	①
CE "H" Level Voltage	V _{CEH}	-	1.1	-	26.0	V	①
CE "L" Level Voltage	V _{CEL}	-	0	-	0.35	V	①
CE "H" Level Current	I _{CEH}	V _{IN} =V _{CE} =26.0V	-0.1	-	0.1	μA	①
CE "L" Level Current	I _{CEL}	V _{IN} =26.0V, V _{CE} =V _{SS}	-0.1	-	0.1	μA	①
Thermal Shutdown Detect Temperature	T _{TSD}	V _{CE} =V _{IN} Junction Temperature	-	150	-	°C	①
Thermal Shutdown Release Temperature	T _{TSR}	V _{CE} =V _{IN} Junction Temperature	-	125	-	°C	①
Hysteresis Width Unless otherwise stated, V _{IN} =V _{OUT(T)} +2.0V.	T _{TSD} -T _{TSR}	V _{CE} =V _{IN} Junction Temperature	-	25	-	°C	-

NOTE:

*1: V_{OUT(T)}: Nominal output voltage

*2: V_{OUT(E)}: Effective output voltage

(i.e. the output voltage when "V_{OUT(T)}+2.0V" is provided at the V_{IN} pin while maintaining a certain I_{OUT} value.)

*3: V_{dif}={V_{IN1} - V_{OUT1}}

V_{OUT1}: V_{OUT(T)}<3.0V, A voltage equal to 98% of the output voltage whenever an amply stabilized I_{OUT}{V_{OUT(T)}+3.0V} is input.

V_{OUT(T)}≥3.0V, A voltage equal to 98% of the output voltage whenever an amply stabilized I_{OUT}{V_{OUT(T)}+2.0V} is input.

V_{IN1}: The input voltage when V_{OUT1} appears as input voltage is gradually decreased.

ELECTRICAL CHARACTERISTICS (Continued)

● Voltage Chart1 (VR)

PARAMETER	E-0		E-1		E-2	
NOMINAL OUTPUT VOLTAGE(V)	OUTPUT VOLTAGE (V) 2% ACCURACY		DROPOUT VOLTAGE 1 (mV) $I_{OUT}=20mA$		DROPOUT VOLTAGE 2 (mV) $I_{OUT}=100mA$	
$V_{OUT(T)}$	$V_{OUT(E)}$		V_{dif1}		V_{dif2}	
	MIN	MAX	TYP	MAX	TYP	MAX
2.0	1.960	2.040	450	600	1900	2600
2.1	2.058	2.142	450	600	1900	2600
2.2	2.156	2.244	390	520	1700	2200
2.3	2.254	2.346	390	520	1700	2200
2.4	2.352	2.448	390	520	1700	2200
2.5	2.450	2.550	310	450	1500	1900
2.6	2.548	2.652	310	450	1500	1900
2.7	2.646	2.754	310	450	1500	1900
2.8	2.744	2.856	310	450	1500	1900
2.9	2.842	2.958	310	450	1500	1900
3.0	2.940	3.060	260	360	1300	1700
3.1	3.038	3.162	260	360	1300	1700
3.2	3.136	3.264	260	360	1300	1700
3.3	3.234	3.366	260	360	1300	1700
3.4	3.332	3.468	260	360	1300	1700
3.5	3.430	3.570	260	360	1300	1700
3.6	3.528	3.672	260	360	1300	1700
3.7	3.626	3.774	260	360	1300	1700
3.8	3.724	3.876	260	360	1300	1700
3.9	3.822	3.978	260	360	1300	1700
4.0	3.920	4.080	220	320	1100	1500
4.1	4.018	4.182	220	320	1100	1500
4.2	4.116	4.284	220	320	1100	1500
4.3	4.214	4.386	220	320	1100	1500
4.4	4.312	4.488	220	320	1100	1500
4.5	4.410	4.590	220	320	1100	1500
4.6	4.508	4.692	220	320	1100	1500
4.7	4.606	4.794	220	320	1100	1500
4.8	4.704	4.896	220	320	1100	1500
4.9	4.802	4.998	220	320	1100	1500

■ ELECTRICAL CHARACTERISTICS (Continued)

● Voltage Chart2 (VR)

PARAMETER	E-0		E-1		E-2	
NOMINAL OUTPUT VOLTAGE(V)	OUTPUT VOLTAGE (V) 2% ACCURACY		DROPOUT VOLTAGE 1 (mV) $I_{OUT}=20mA$		DROPOUT VOLTAGE 2 (mV) $I_{OUT}=100mA$	
$V_{OUT(T)}$	$V_{OUT(E)}$		V_{dif1}		V_{dif2}	
	MIN	MAX	TYP	MAX	TYP	MAX
5.0	4.900	5.100	190	280	1000	1300
5.1	4.998	5.202	190	280	1000	1300
5.2	5.096	5.304	190	280	1000	1300
5.3	5.194	5.406	190	280	1000	1300
5.4	5.292	5.508	190	280	1000	1300
5.5	5.390	5.610	190	280	1000	1300
5.6	5.488	5.712	190	280	1000	1300
5.7	5.586	5.814	190	280	1000	1300
5.8	5.684	5.916	190	280	1000	1300
5.9	5.782	6.018	190	280	1000	1300
6.0	5.880	6.120	190	280	1000	1300
6.1	5.978	6.222	190	280	1000	1300
6.2	6.076	6.324	190	280	1000	1300
6.3	6.174	6.426	190	280	1000	1300
6.4	6.272	6.528	190	280	1000	1300
6.5	6.370	6.630	170	230	800	1150
6.6	6.468	6.732	170	230	800	1150
6.7	6.566	6.834	170	230	800	1150
6.8	6.664	6.936	170	230	800	1150
6.9	6.762	7.038	170	230	800	1150
7.0	6.860	7.140	170	230	800	1150
7.1	6.958	7.242	170	230	800	1150
7.2	7.056	7.344	170	230	800	1150
7.3	7.154	7.446	170	230	800	1150
7.4	7.252	7.548	170	230	800	1150
7.5	7.350	7.650	170	230	800	1150
7.6	7.448	7.752	170	230	800	1150
7.7	7.546	7.854	170	230	800	1150
7.8	7.644	7.956	170	230	800	1150
7.9	7.742	8.058	170	230	800	1150
8.0	7.840	8.160	170	230	800	1150

ELECTRICAL CHARACTERISTICS(Continued)

● Voltage Chart3 (VR)

PARAMETER	E-0		E-1		E-2	
NOMINAL OUTPUT VOLTAGE(V)	OUTPUT VOLTAGE (V) 2% ACCURACY		DROPOUT VOLTAGE 1 (mV) $I_{OUT}=20mA$		DROPOUT VOLTAGE 2 (mV) $I_{OUT}=100mA$	
$V_{OUT(T)}$	$V_{OUT(E)}$		V_{dif1}		V_{dif2}	
	MIN	MAX	TYP	MAX	TYP	MAX
8.1	7.938	8.262	130	190	700	950
8.2	8.036	8.364	130	190	700	950
8.3	8.134	8.466	130	190	700	950
8.4	8.232	8.568	130	190	700	950
8.5	8.330	8.670	130	190	700	950
8.6	8.428	8.772	130	190	700	950
8.7	8.526	8.874	130	190	700	950
8.8	8.624	8.976	130	190	700	950
8.9	8.722	9.078	130	190	700	950
9.0	8.820	9.180	130	190	700	950
9.1	8.918	9.282	130	190	700	950
9.2	9.016	9.384	130	190	700	950
9.3	9.114	9.486	130	190	700	950
9.4	9.212	9.588	130	190	700	950
9.5	9.310	9.690	130	190	700	950
9.6	9.408	9.792	130	190	700	950
9.7	9.506	9.894	130	190	700	950
9.8	9.604	9.996	130	190	700	950
9.9	9.702	10.098	130	190	700	950
10.0	9.800	10.200	130	190	700	950
10.1	9.898	10.302	120	160	650	850
10.2	9.996	10.404	120	160	650	850
10.3	10.094	10.506	120	160	650	850
10.4	10.192	10.608	120	160	650	850
10.5	10.290	10.710	120	160	650	850
10.6	10.388	10.812	120	160	650	850
10.7	10.486	10.914	120	160	650	850
10.8	10.584	11.016	120	160	650	850
10.9	10.682	11.118	120	160	650	850
11.0	10.780	11.220	120	160	650	850
11.1	10.878	11.322	120	160	650	850
11.2	10.976	11.424	120	160	650	850
11.3	11.074	11.526	120	160	650	850
11.4	11.172	11.628	120	160	650	850
11.5	11.270	11.730	120	160	650	850
11.6	11.368	11.832	120	160	650	850
11.7	11.466	11.934	120	160	650	850
11.8	11.564	12.036	120	160	650	850
11.9	11.662	12.138	120	160	650	850
12.0	11.760	12.240	120	160	650	850

TEST CIRCUITS

●Circuit①

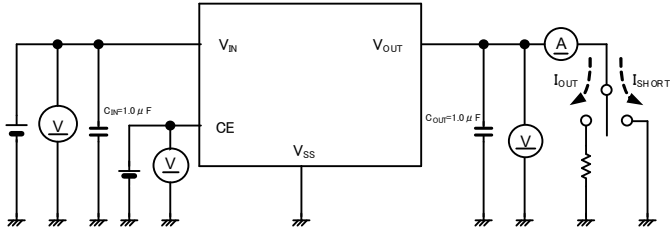

●Circuit②

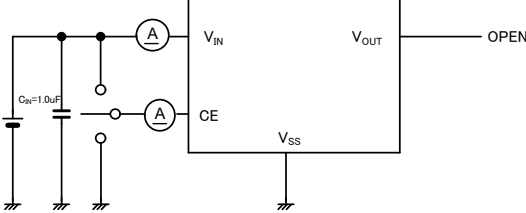

●Circuit③

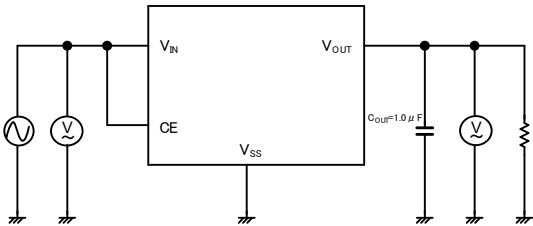

Please open all the SBD pins (IN1, IN2, POS, NEG) of the bridge circuit.

Representative Components Example

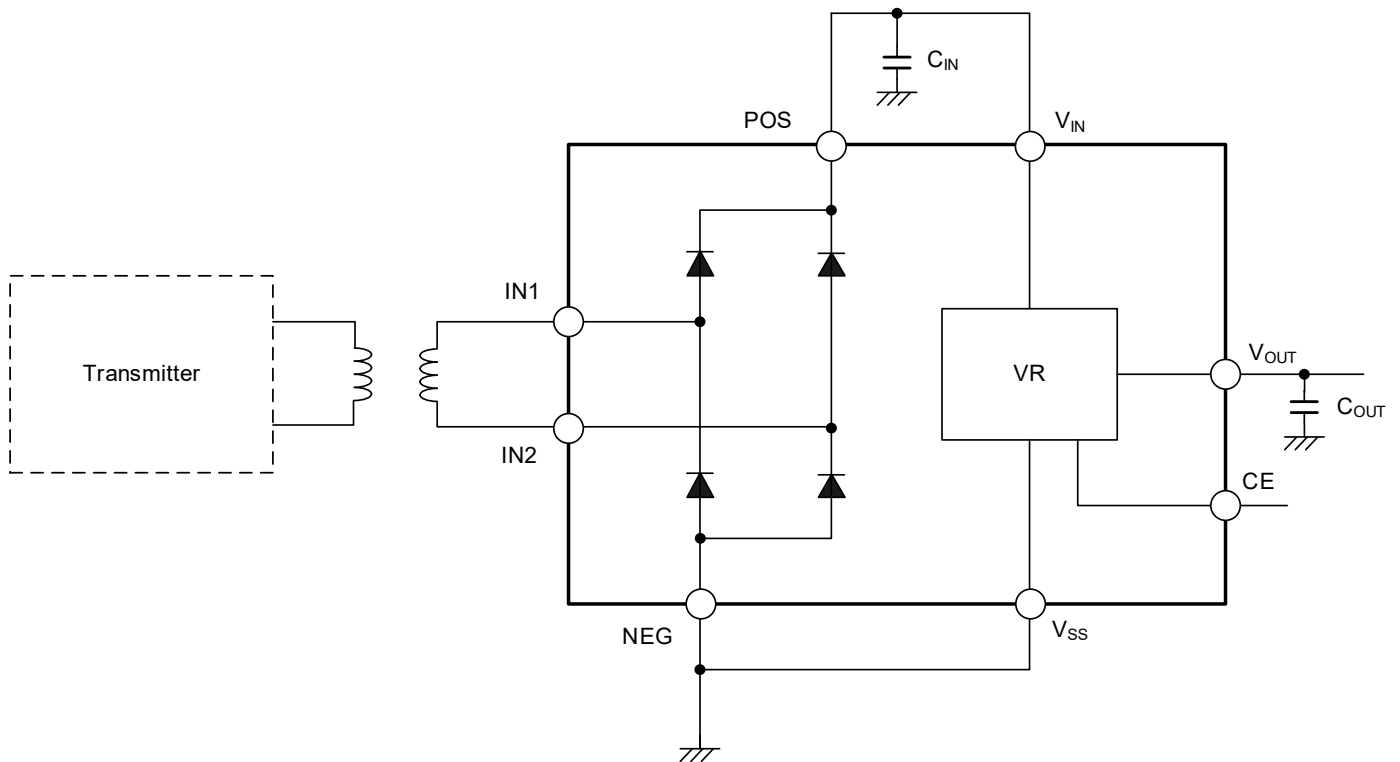

Example) AC Input Voltage $\pm 10V$, $V_{OUT}=5.0V$

	MANUFACTURER	PRODUCT NUMBER	VALUE	SIZE(L × W × T)
C _{IN}	TDK	CGB2A1X5R1E105K	1 μ F/25V	1.0 × 0.5 × 0.33(mm)
	Murata	GRM033R61E474ME15	0.47 μ F/25V, 2 parallel	0.6 × 0.3 × 0.39(mm)
C _{OUT}	TDK	CGB2A3X5R0J105K033BB	1 μ F/6.3V	1.0 × 0.5 × 0.33(mm)
	Murata	GRM153R60J105ME15D	1 μ F/6.3V	1.0 × 0.5 × 0.33(mm)
	TDK	CGB2A1X5R1A105K	1 μ F/10V	1.0 × 0.5 × 0.33(mm)
	Murata	GRM153R61A105ME95	1 μ F/10V	1.0 × 0.5 × 0.33(mm)

■ OPERATIONAL EXPLANATION

<Bridge Circuit>

IN1 and IN2 are input pins for the bridge circuit consisted of four SBDs. The full rectified wave form on NEG pin basis is output from the POS pin. Please connect POS pin with V_{IN} pin, and connect NEG pin and V_{SS} pin with the ground. To stabilize the input voltage of the regulator part, please add a ceramic capacitor between V_{SS} pin and V_{IN} pin.

< Voltage Regulators Circuit>

The voltage divided by resistors is compared with the internal reference voltage by the error amplifier. The P-channel MOSFET which is connected to the VOUT pin is then driven by the subsequent controlled signal. The output voltage at the VOUT pin is controlled and stabilized by a system of negative feedback. The current limit circuit and short protect circuit operate in relation to the level of output current and heat dissipation. Further, the IC's internal circuitry can be shutdown via the CE pin's signal.

<Short-Circuit Protection>

The Voltage circuit includes a current fold-back circuit as a short circuit protection. When the load current reaches the current limit level, the current fold-back circuit operates and output voltage drops. The output voltage drops further and output current decreases. When the output pin is shorted, a current of about 30mA flows.

<CE Pin>

The IC's internal circuitry can be shutdown via the signal from the CE pin. In shutdown mode, output at the VOUT pin will be pulled down by divided resistors to the V_{SS} level. We suggest that you use this IC with either a V_{IN} voltage or a V_{SS} voltage input at the CE pin. If this IC is used with the correct specifications for the CE pin, the operational logic is fixed and the IC will operate normally. However, supply current may increase as a result of through current in the IC's internal circuitry if a medium voltage is applied.

<Thermal Protection>

When the junction temperature of the built-in driver transistor reaches the temperature limit, the thermal shutdown circuit operates and the driver transistor will be set to OFF. The IC resumes its operation when the thermal shutdown function is released and the IC's operation is automatically restored because the junction temperature drops to the level of the thermal shutdown release voltage.

<Minimum Operating Voltage>

For the stable operation of the IC, over 2.0V of input voltage is necessary. The output voltage may not be generated normally if the input voltage is less than 2.0V.

■ NOTES ON USE

1. Please use this IC within the stated absolute maximum ratings. The IC is liable to malfunction should the ratings be exceeded.
2. Where wiring impedance is high, operations may become unstable due to the noise and/or phase lag depending on output current. Please strengthen V_{IN} and V_{SS} wiring in particular.
3. Since the absolute maximum rated voltage of the Schottky Barrier Diode is 40V, the AC input voltage input to the IN 1 terminal and IN 2 terminal should not exceed $\pm 20V$.
4. In order to smooth the full-wave rectified output by the bridge circuit and stabilize the input of the voltage regulator, an input capacitor C_{IN} of about $1.0\mu F$ is required between the power supply input pin (V_{IN}) and the ground pin (V_{SS}). When increasing the capacitance value, select the input capacitor (C_{IN}) so that the inrush current at power-on will not exceed the peak forward surge current 1A of the Schottky Barrier Diode. In addition, it is necessary to connect the NEG terminal of the bridge circuit and the ground terminal (V_{SS}) of the voltage regulator circuit.
5. The output voltage fluctuation such as under shoot or over shoot, which occurs because of the load change can be controlled by placing the output capacitor C_{OUT} around $0.1\mu F \sim 1.0\mu F$ between the V_{OUT} pin and V_{SS} pin. The input capacitor (C_{IN}) and the output capacitor (C_{OUT}) should be placed to the IC as close as possible with a shorter wiring.
6. Torex places an importance on improving our products and their reliability. We request that users incorporate fail-safe designs and post-aging protection treatment when using Torex products in their systems.

TYPICAL PERFORMANCE CHARACTERISTICS

● Voltage Regulator (VR)

(1) Output Voltage vs. Output Current

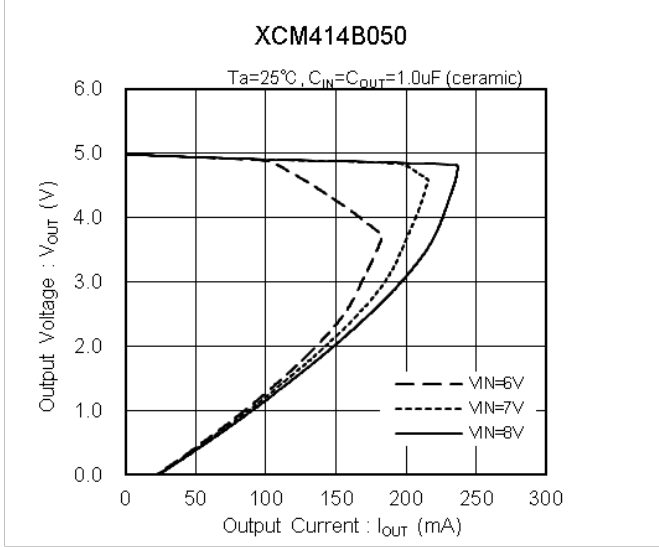
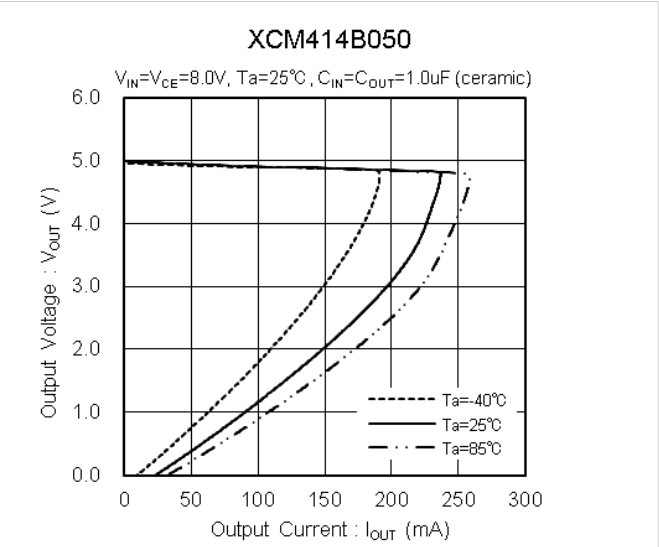
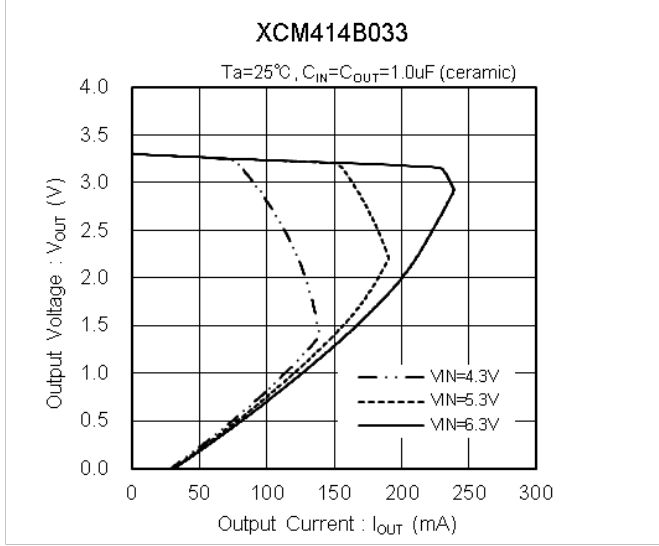
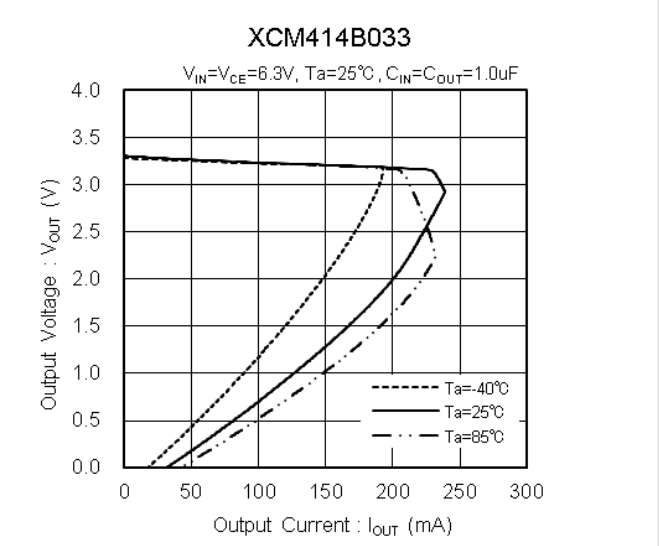
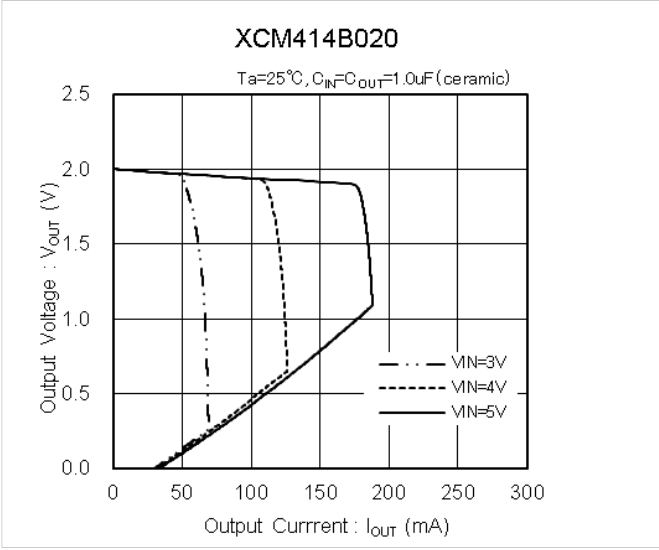
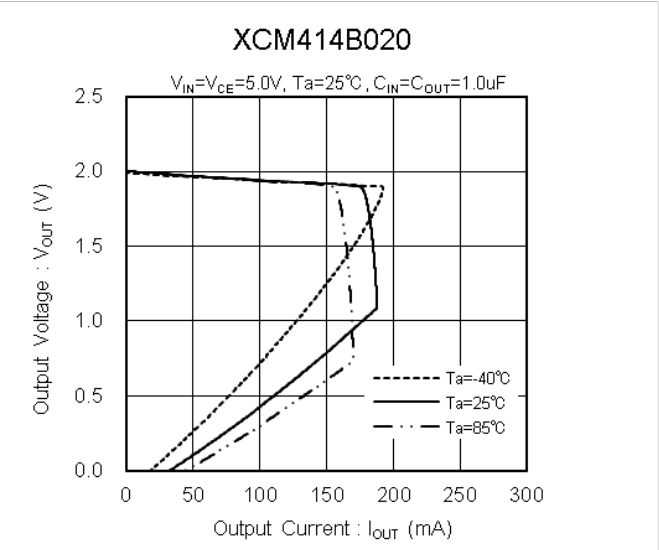

TYPICAL PERFORMANCE CHARACTERISTICS (Continued)

(1) Output Voltage vs. Output Current (Continued)

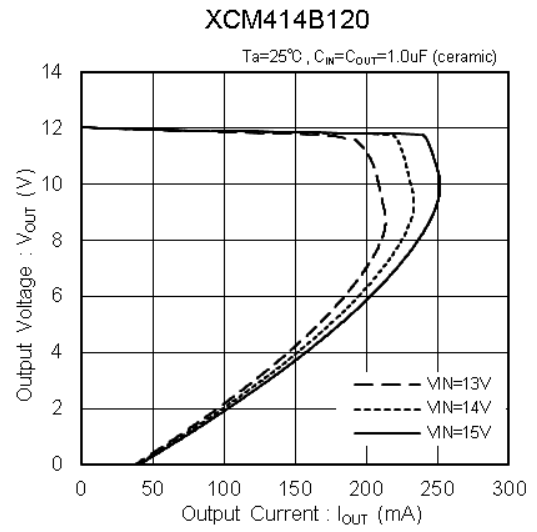
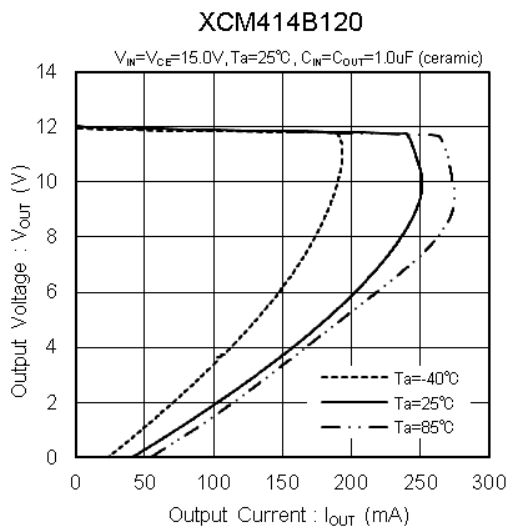

(2) Output Voltage vs. Input Voltage

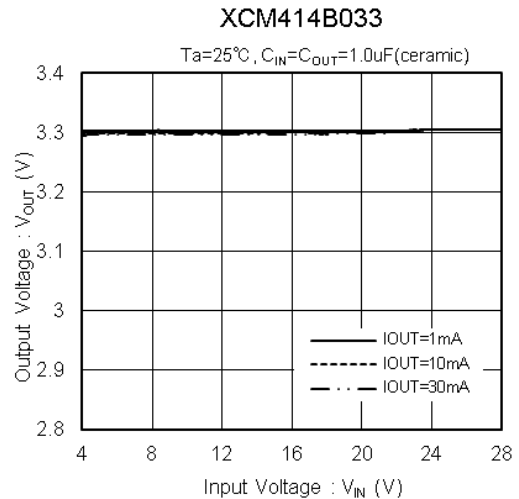
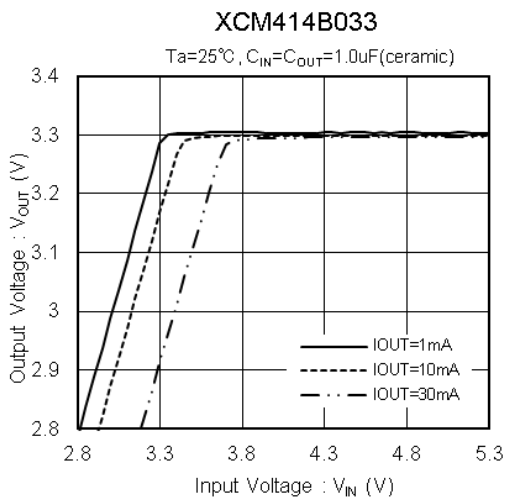
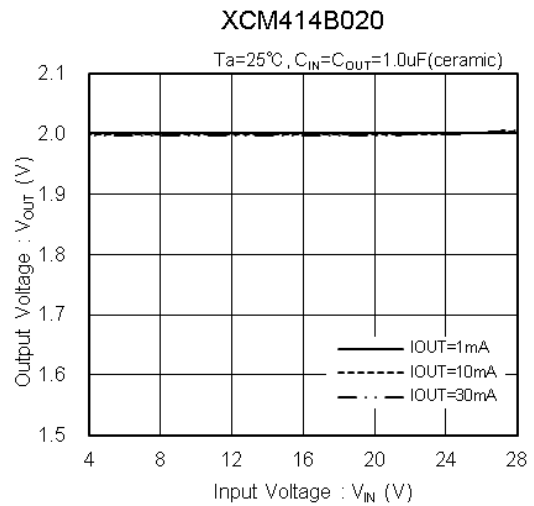
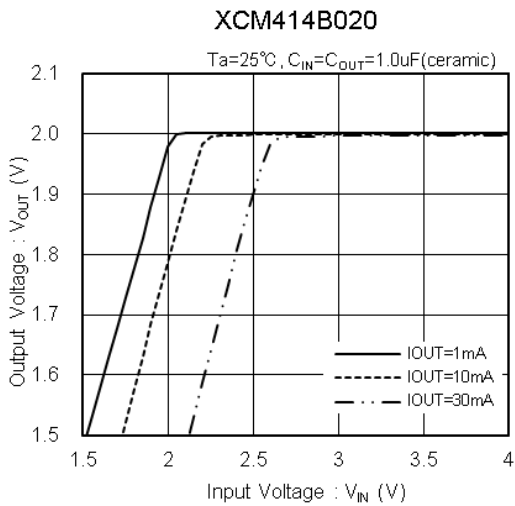

TYPICAL PERFORMANCE CHARACTERISTICS (Continued)

(2) Output Voltage vs. Input Voltage (Continued)

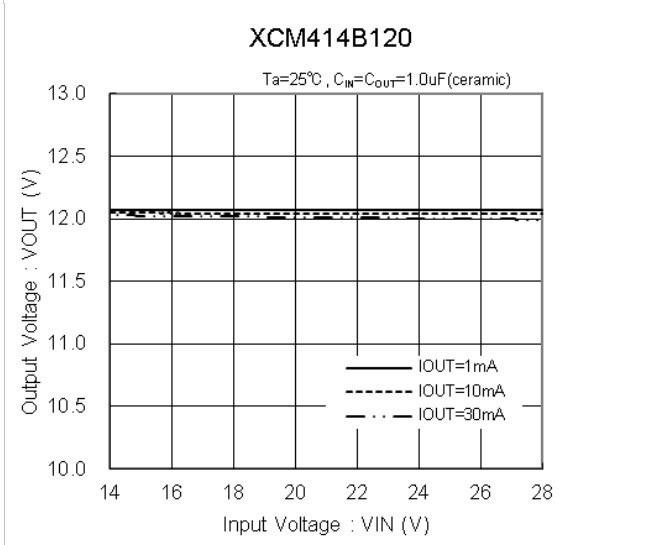
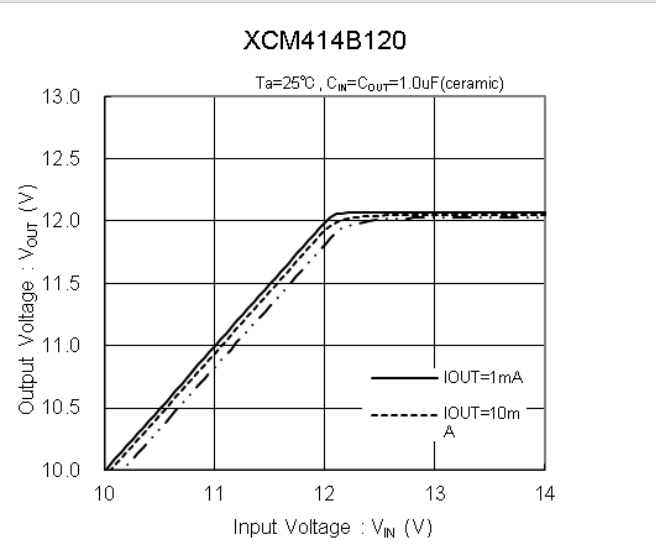
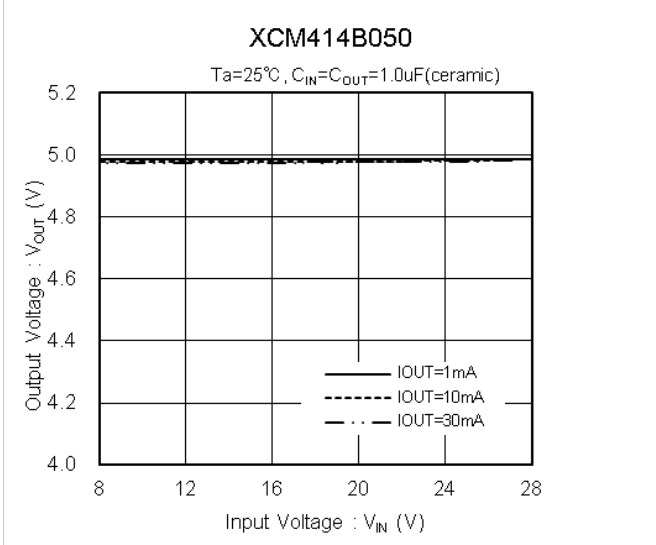
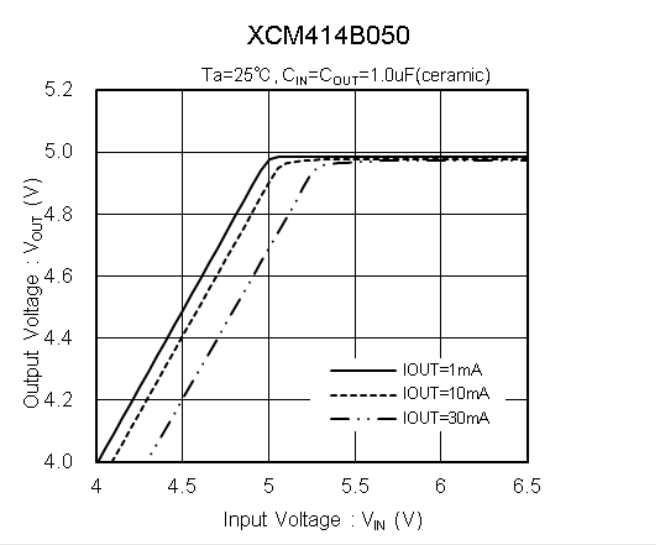

(3) Dropout Voltage vs. Output Current

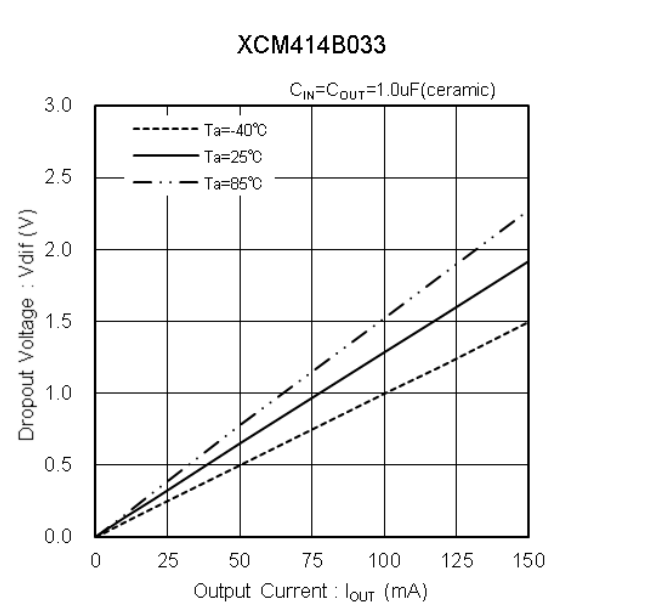
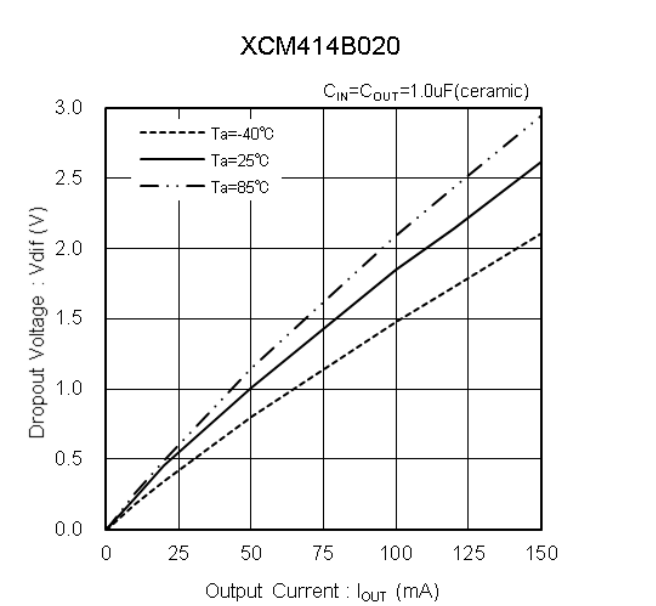

TYPICAL PERFORMANCE CHARACTERISTICS (Continued)

(3) Dropout Voltage vs. Output Current (Continued)

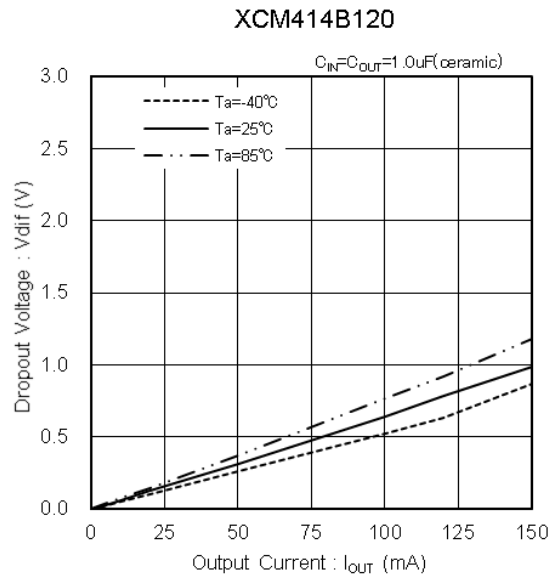
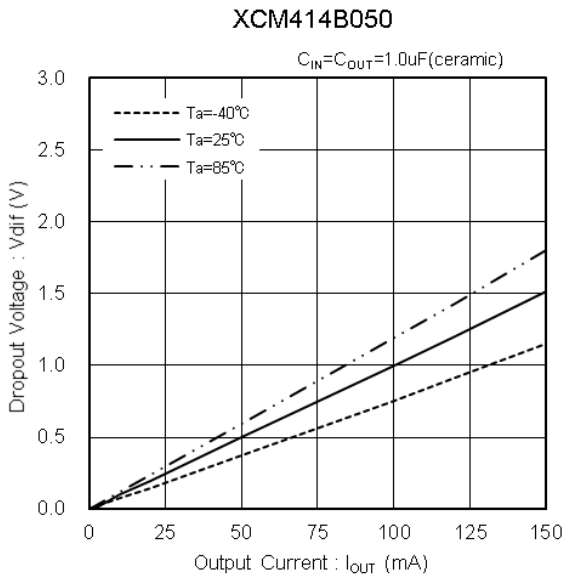

(4) Supply Current vs. Input Voltage

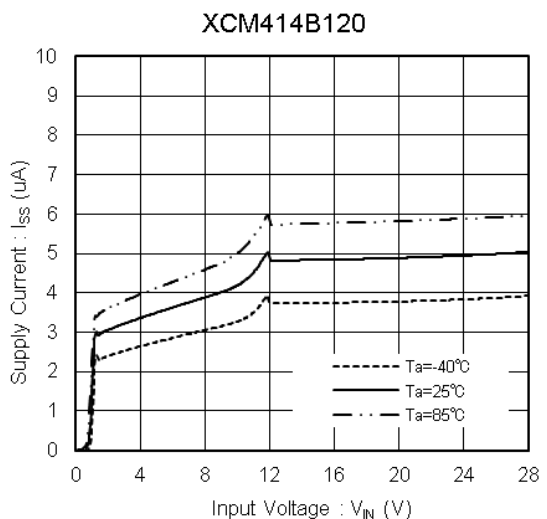
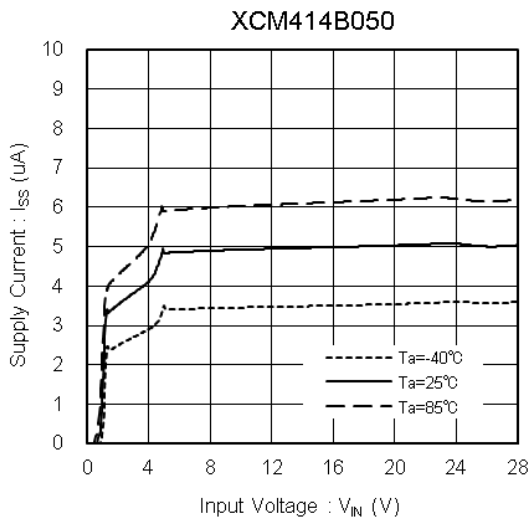
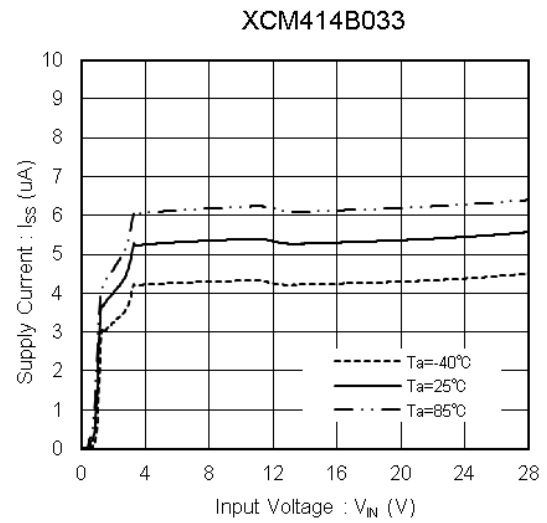
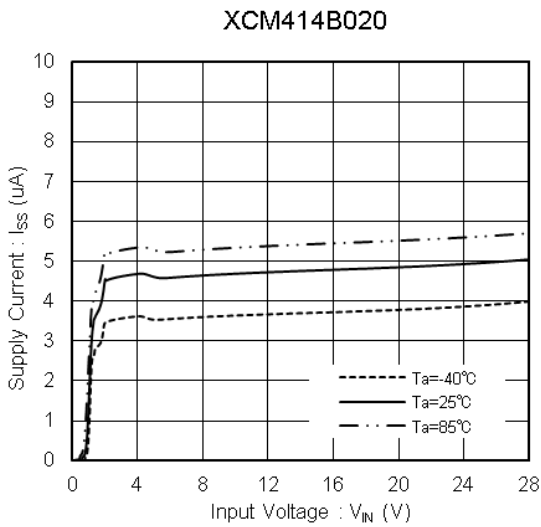

TYPICAL PERFORMANCE CHARACTERISTICS (Continued)

(5) Supply Current vs. Ambient Temperature

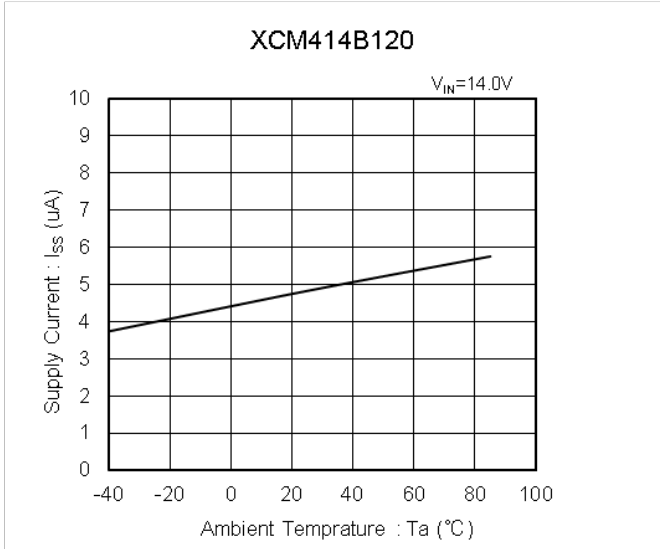
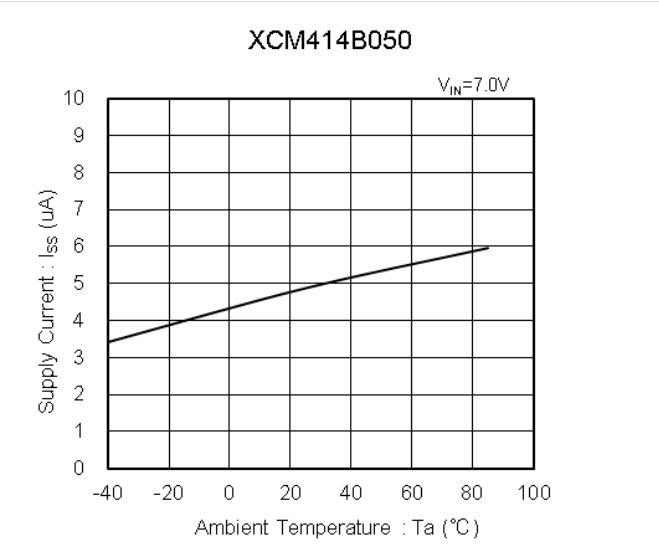
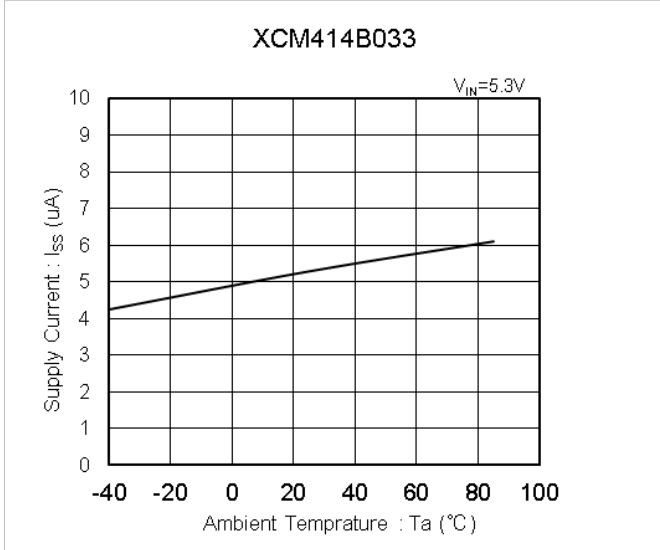
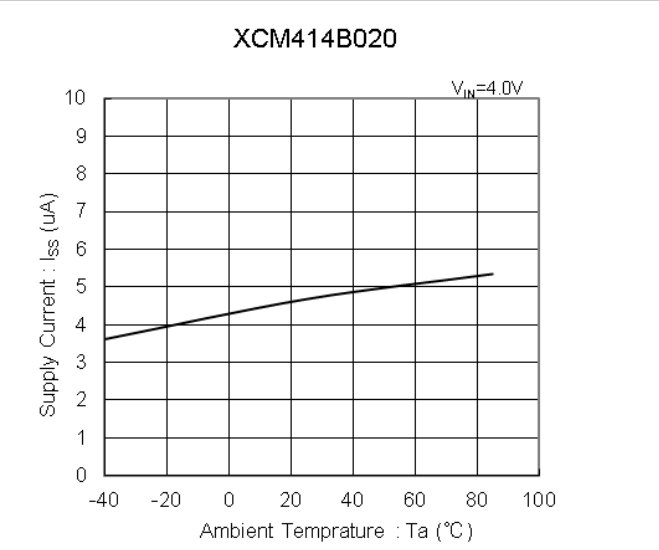

(6) Output Voltage vs. Ambient Temperature

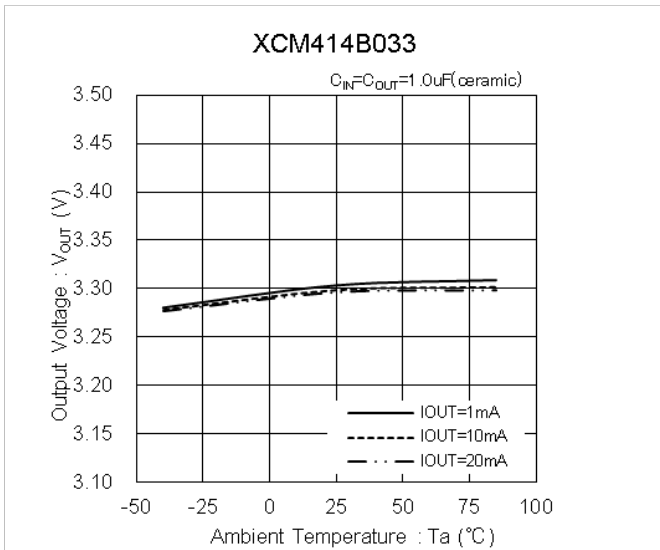
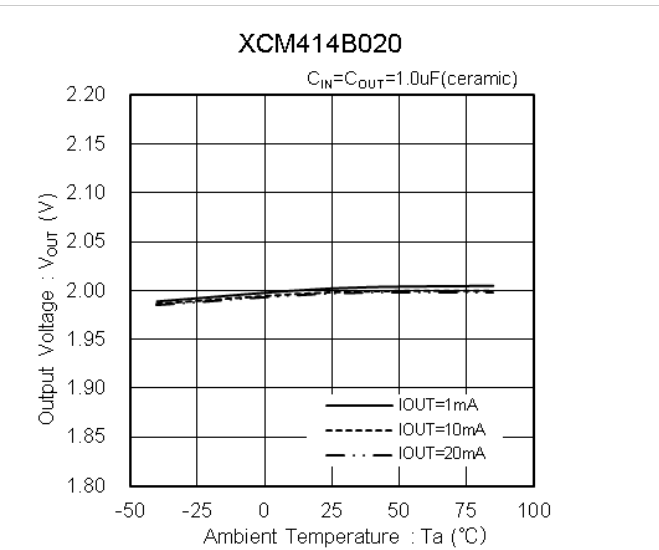

TYPICAL PERFORMANCE CHARACTERISTICS (Continued)

(6) Output Voltage vs. Ambient Temperature (Continued)

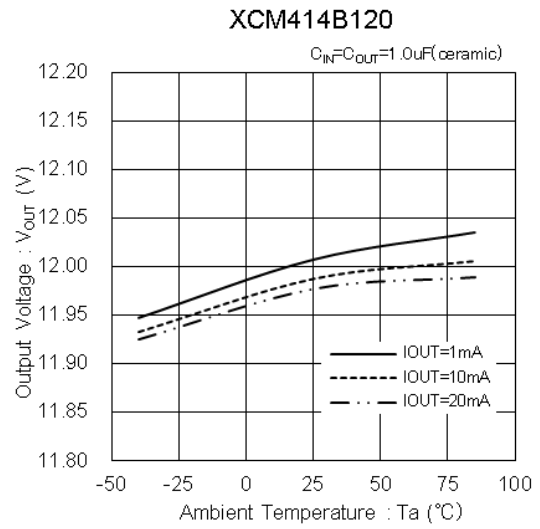
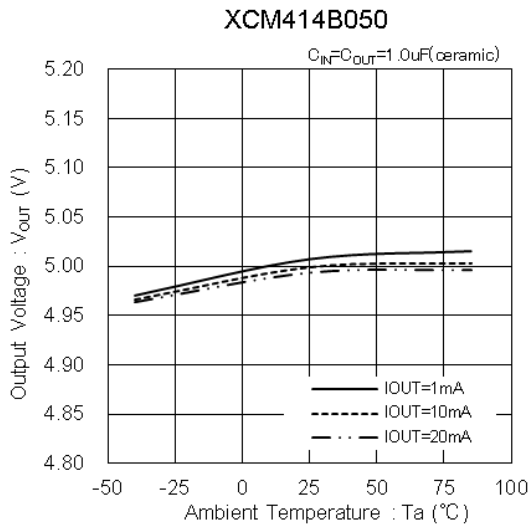

(7) Line Transient Response

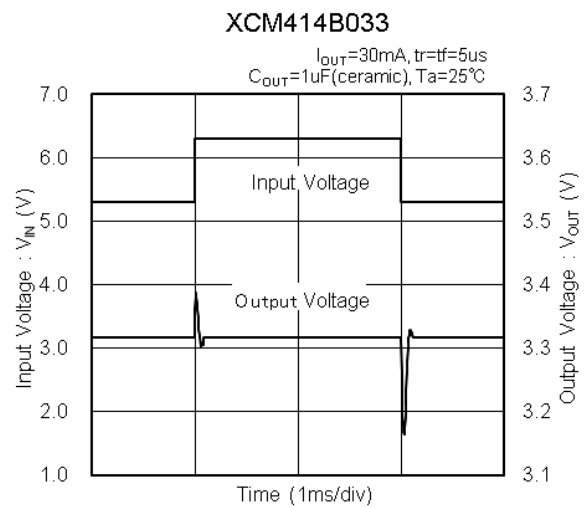
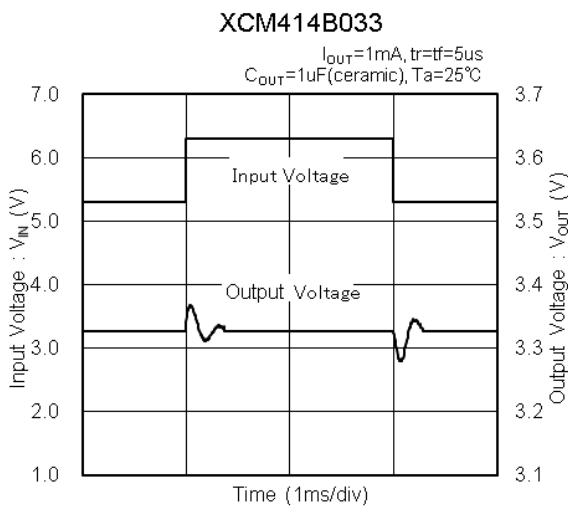
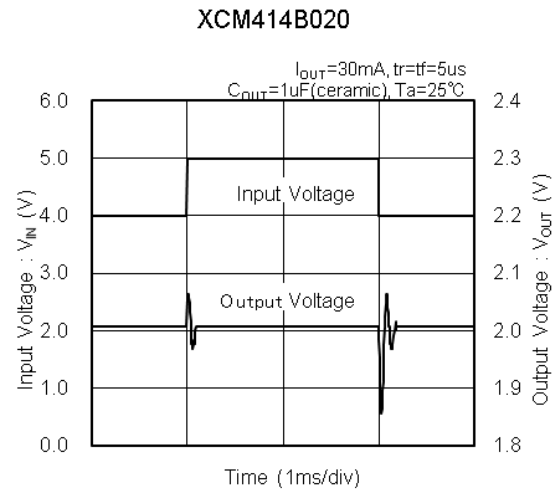
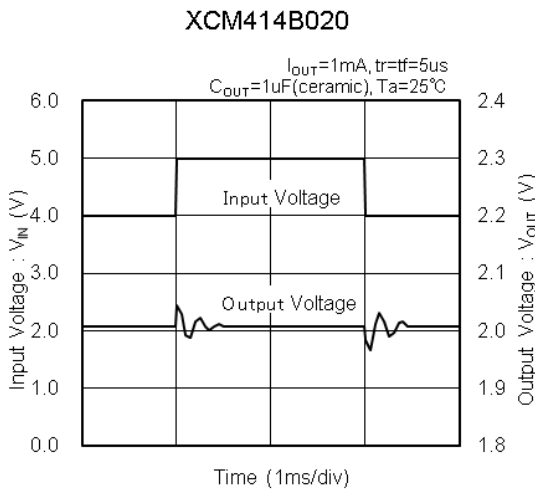

TYPICAL PERFORMANCE CHARACTERISTICS (Continued)

(7) Line Transient Response (Continued)

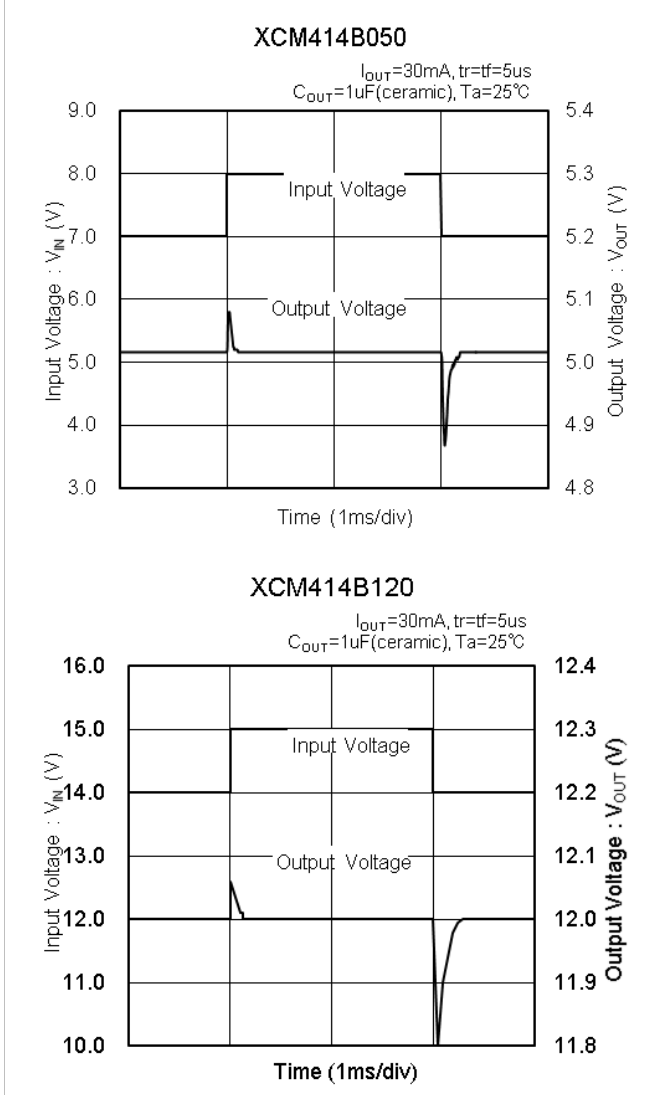
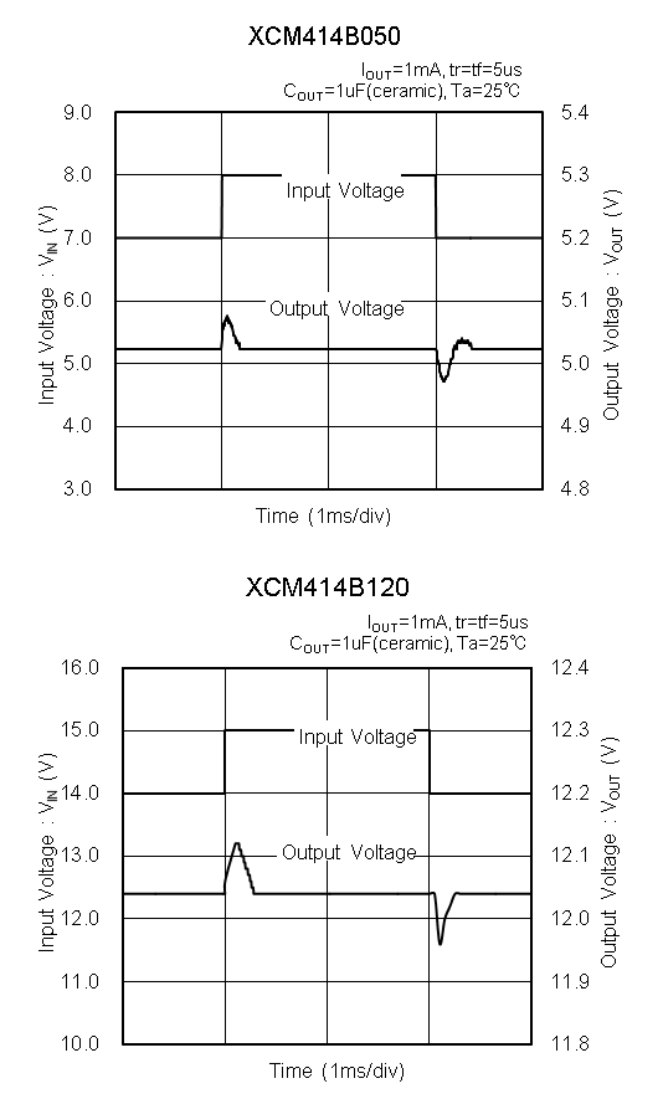

(8) Load Transient Response

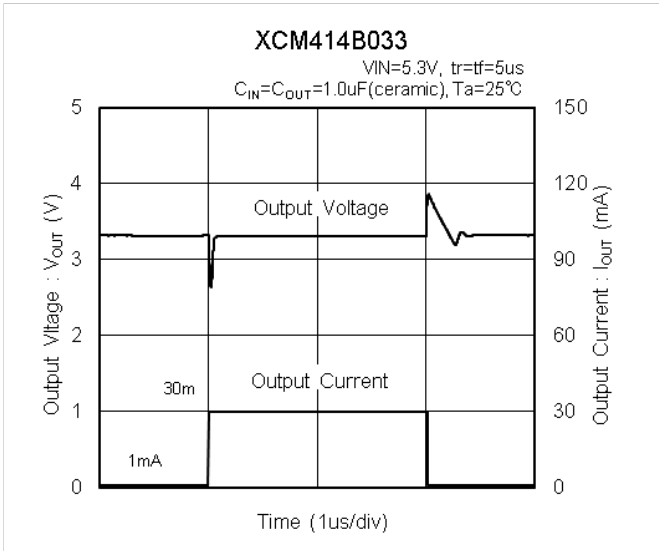
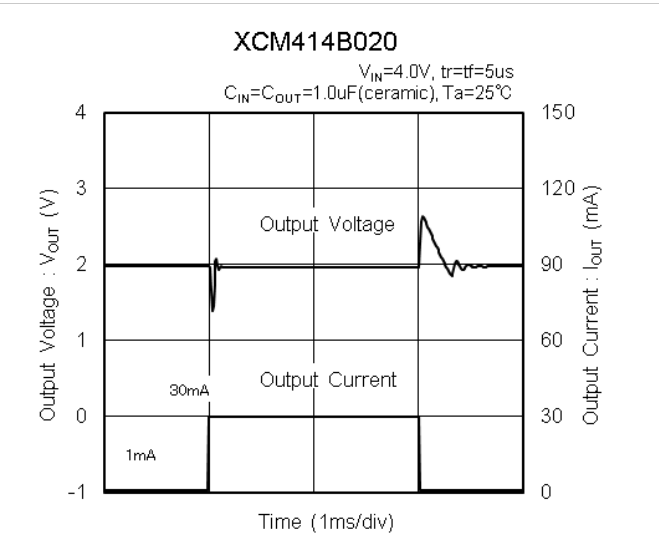

TYPICAL PERFORMANCE CHARACTERISTICS (Continued)

(8) Load Transient Response (Continued)

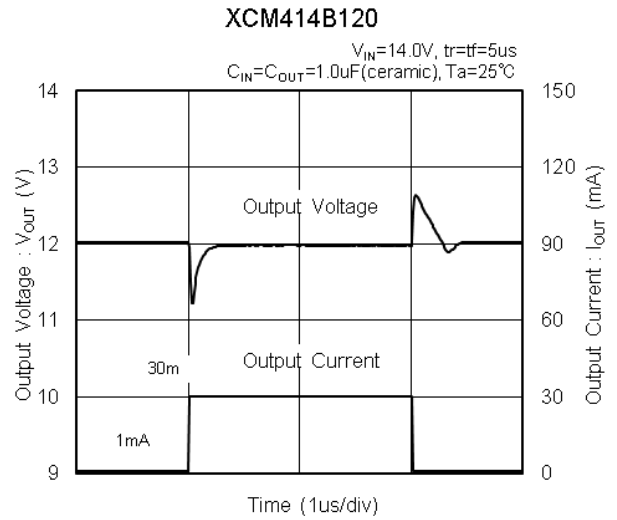
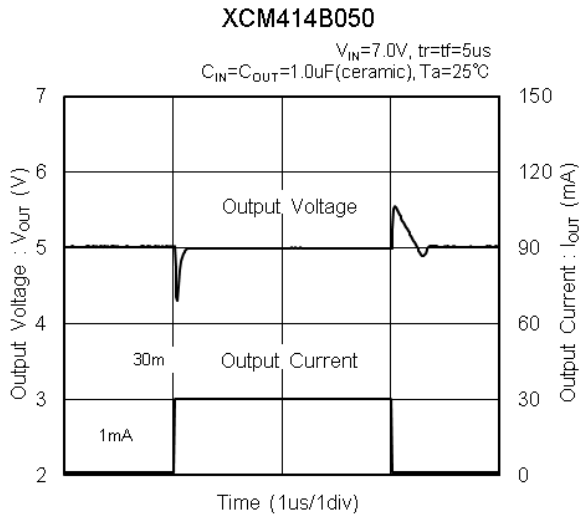

(9) Input Rise Time

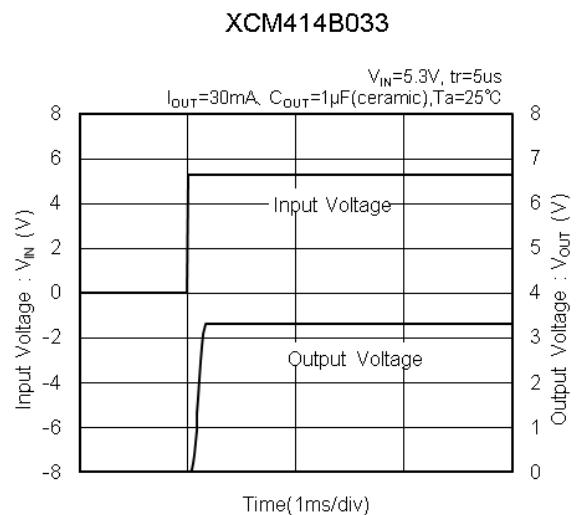
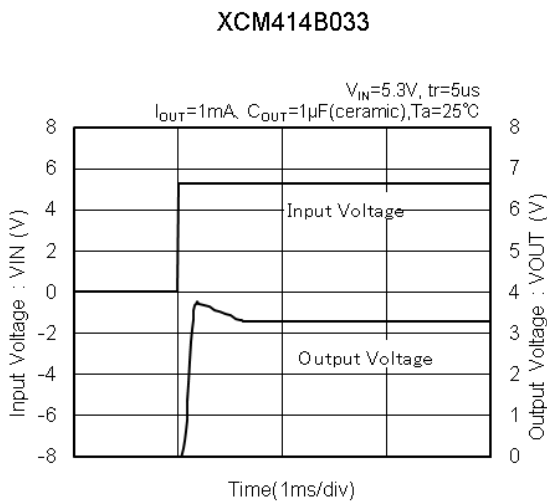
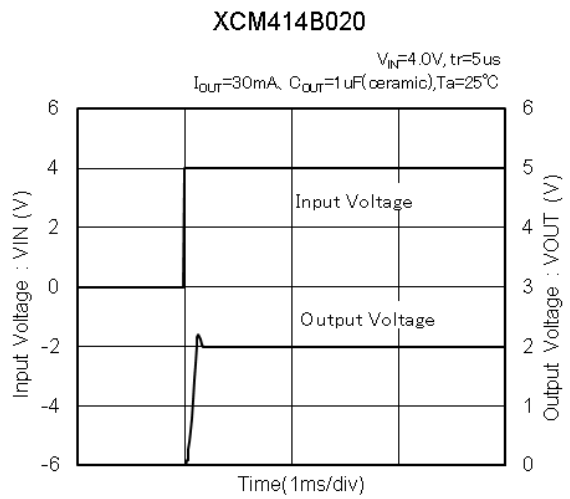
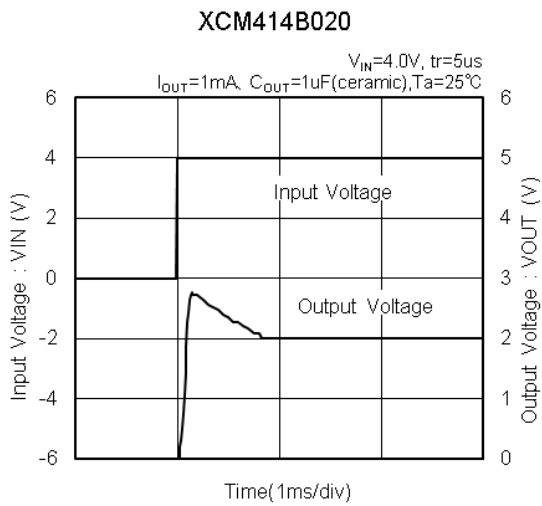

TYPICAL PERFORMANCE CHARACTERISTICS (Continued)

(9) Input Rise Time (Continued)

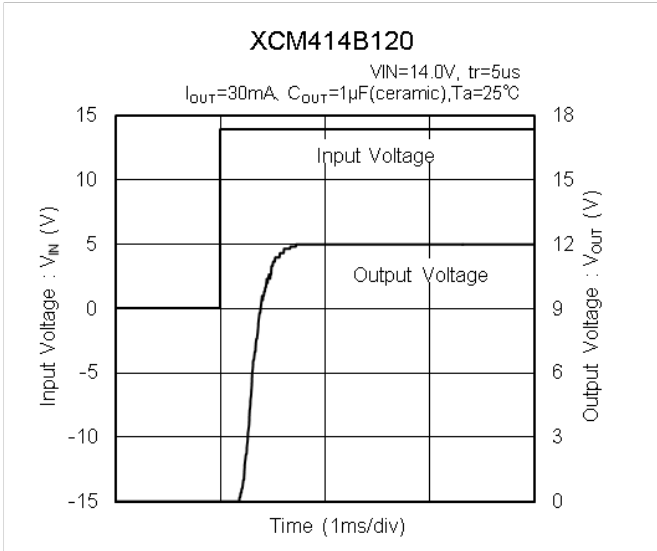
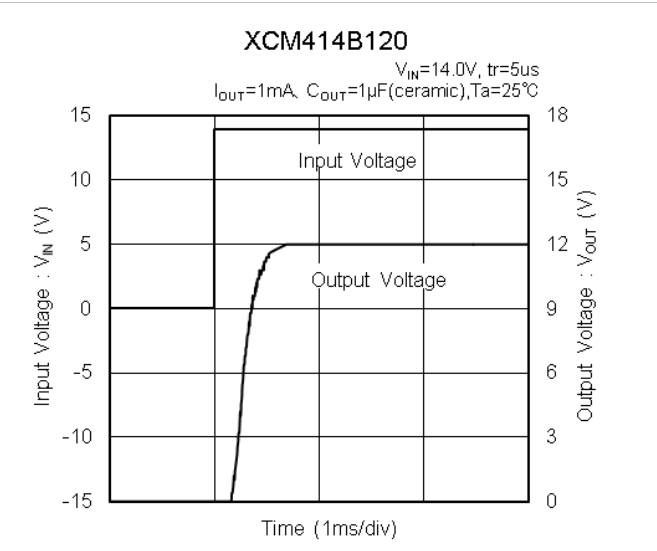
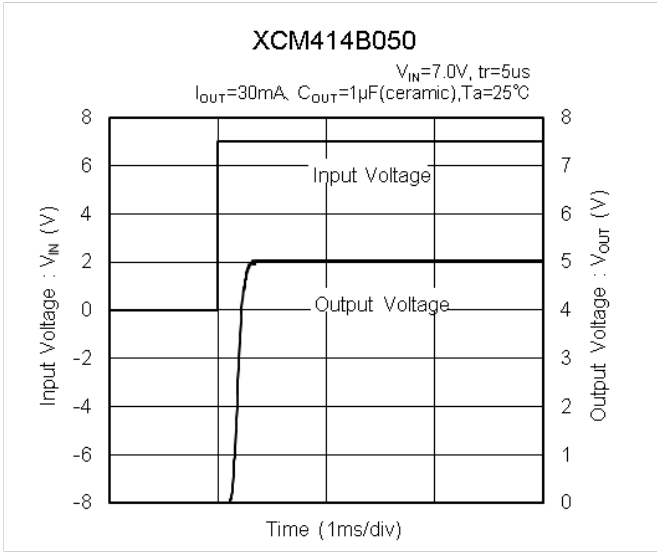
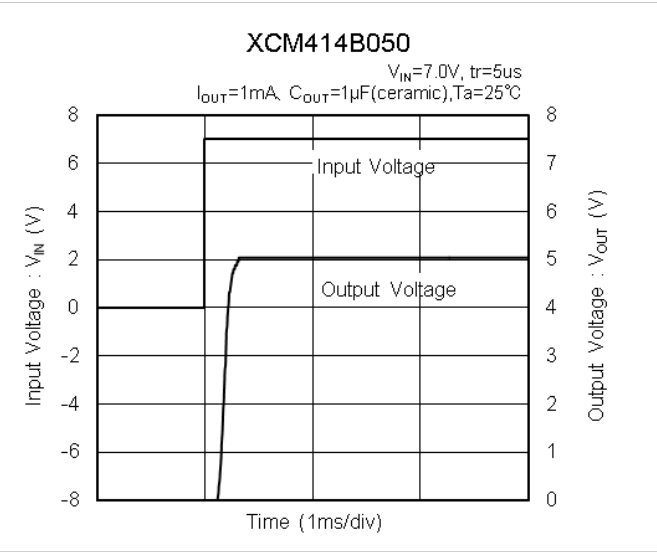

(10) CE Rise Time

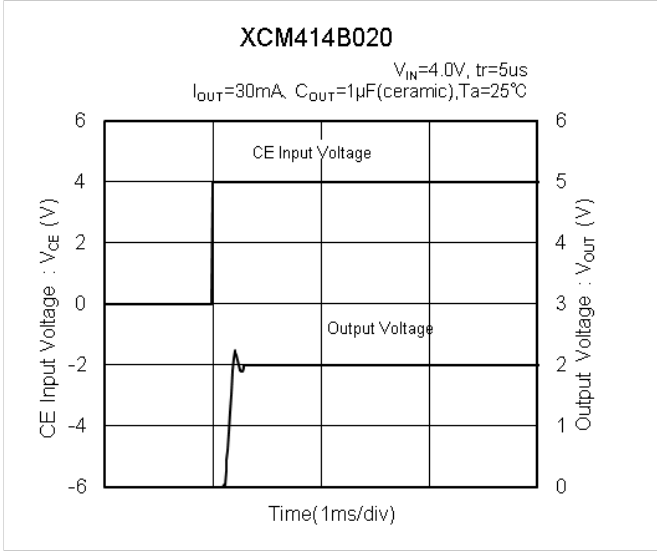
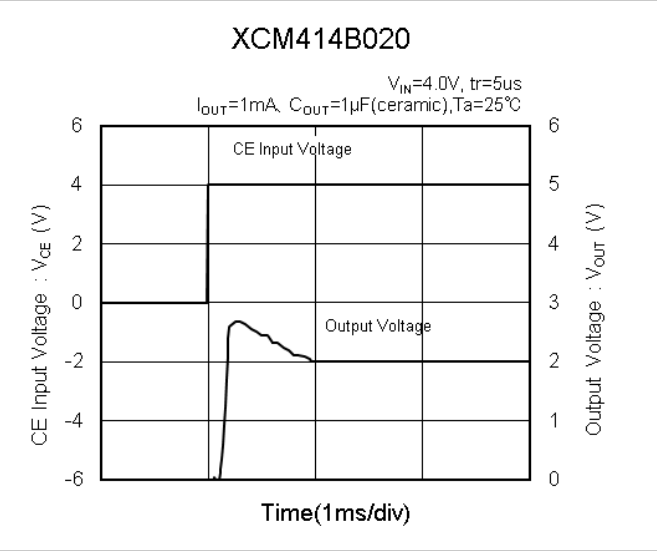

TYPICAL PERFORMANCE CHARACTERISTICS (Continued)

(10) CE Rise Time (Continued)

XCM414B033

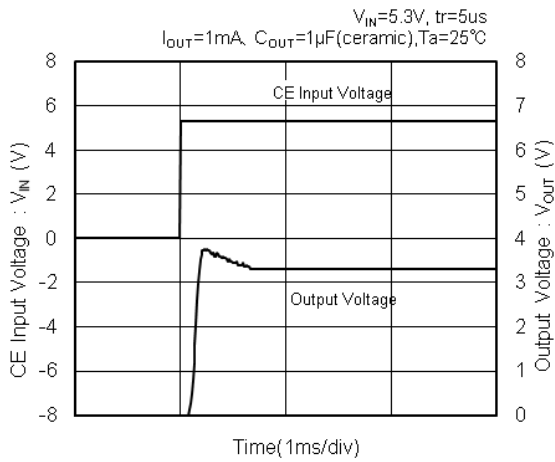

XCM414B033

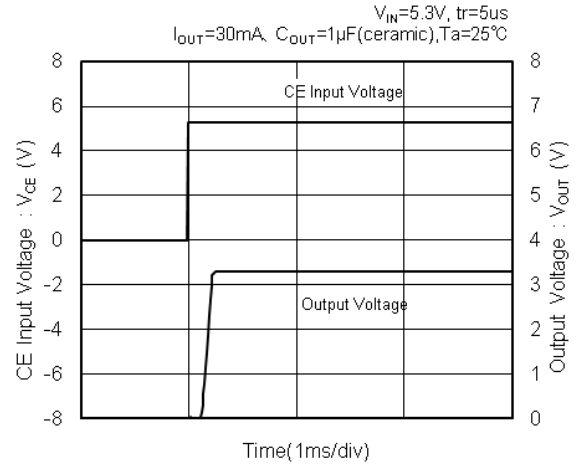

XCM414B050

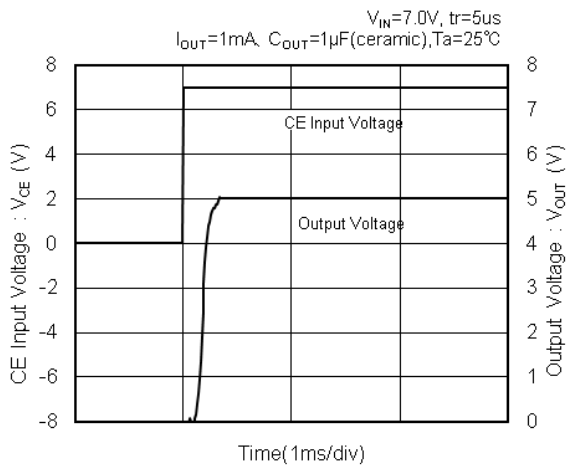

XCM414B050

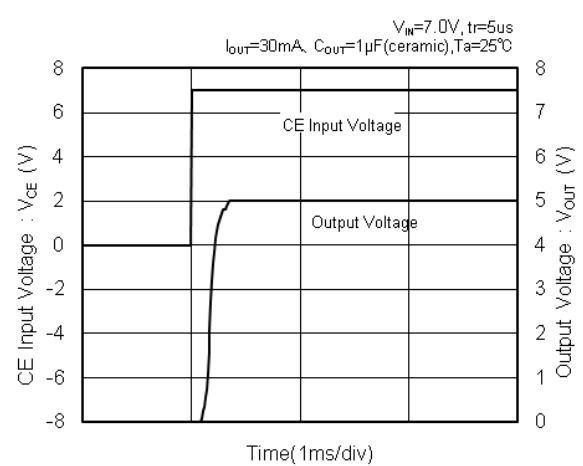

XCM414B120

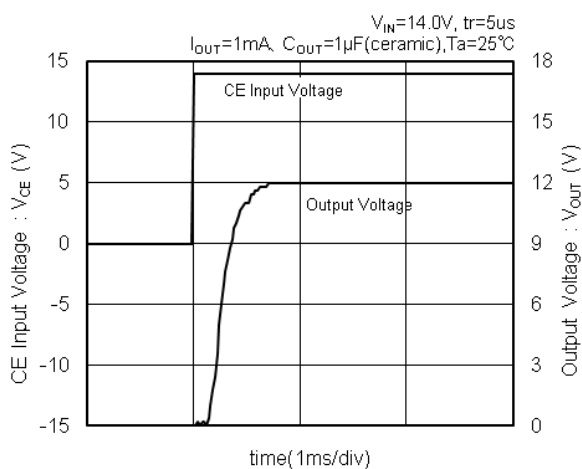

XCM414B120

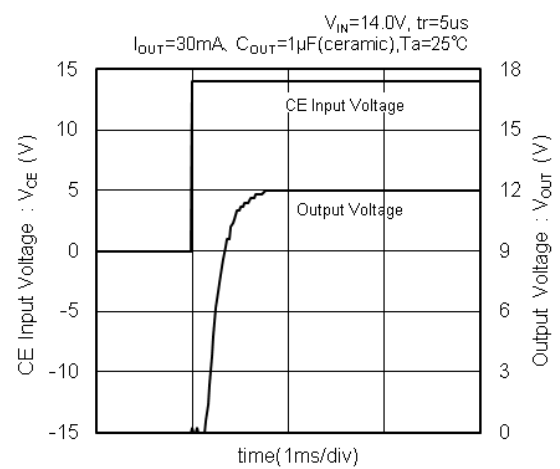

TYPICAL PERFORMANCE CHARACTERISTICS (Continued)

(11) Ripple Rejection Rate

XCM414B020

$V_{IN}=4.0V_{dc}+0.5V_{p-p}$, $I_{OUT}=1mA$
 $C_{OUT}=1\mu F$ (ceramic), $T_a=25^\circ C$

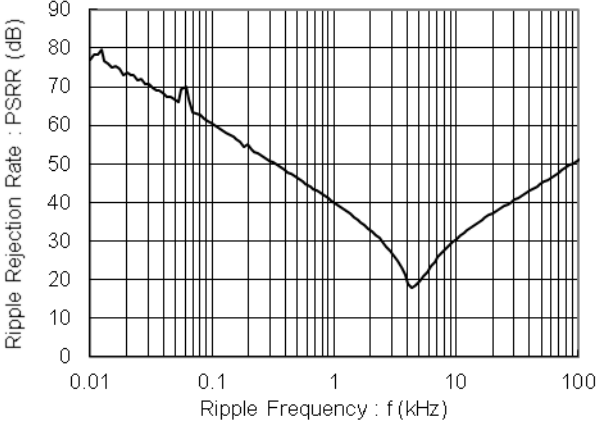

XCM414B020

$V_{IN}=4.0V_{dc}+0.5V_{p-p}$, $I_{OUT}=30mA$
 $C_{OUT}=1\mu F$ (ceramic), $T_a=25^\circ C$

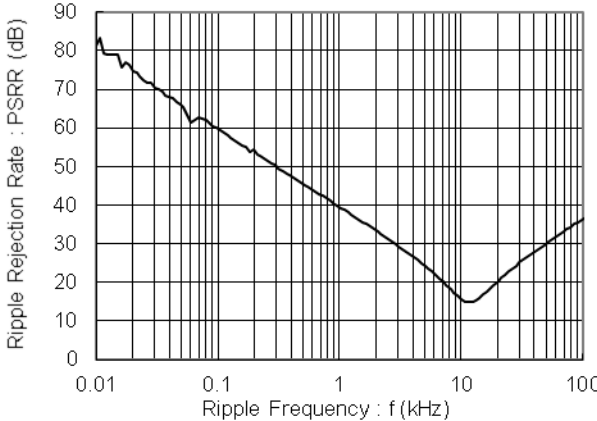

XCM414B033

$V_{IN}=5.3V_{dc}+0.5V_{p-p}$, $I_{OUT}=1mA$
 $C_{OUT}=1\mu F$ (ceramic), $T_a=25^\circ C$

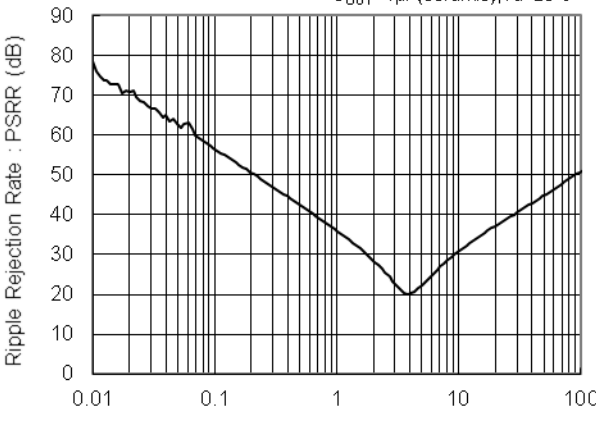

XCM414B033

$V_{IN}=5.3V_{dc}+0.5V_{p-p}$, $I_{OUT}=30mA$
 $C_{OUT}=1\mu F$ (ceramic), $T_a=25^\circ C$

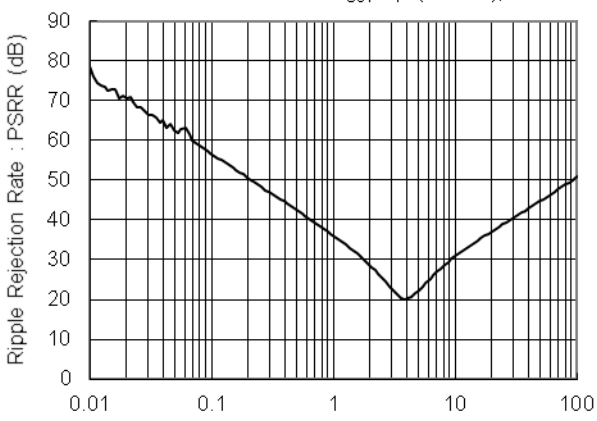

XCM414B050

$V_{IN}=7.0V_{dc}+0.5V_{p-p}$, $I_{OUT}=1mA$
 $C_{OUT}=1\mu F$ (ceramic), $T_a=25^\circ C$

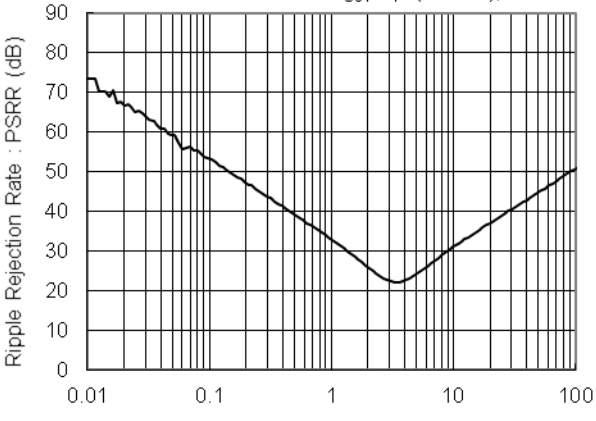

XCM414B050

$V_{IN}=7.0V_{dc}+0.5V_{p-p}$, $I_{OUT}=30mA$
 $C_{OUT}=1\mu F$ (ceramic), $T_a=25^\circ C$

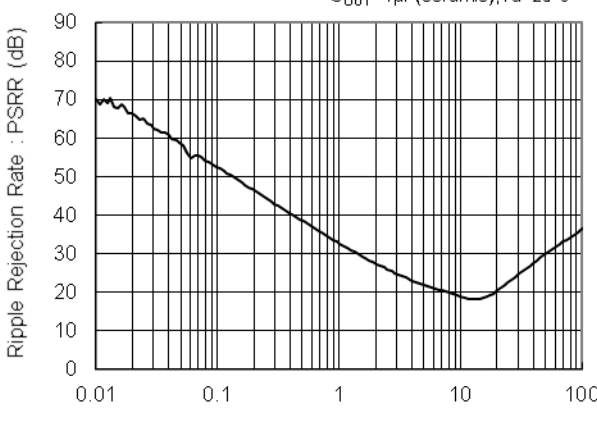

TYPICAL PERFORMANCE CHARACTERISTICS (Continued)

(11) Ripple Rejection Rate (Continued)

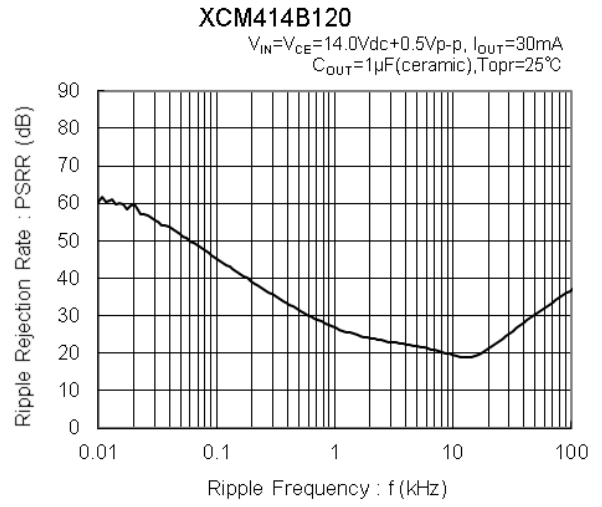
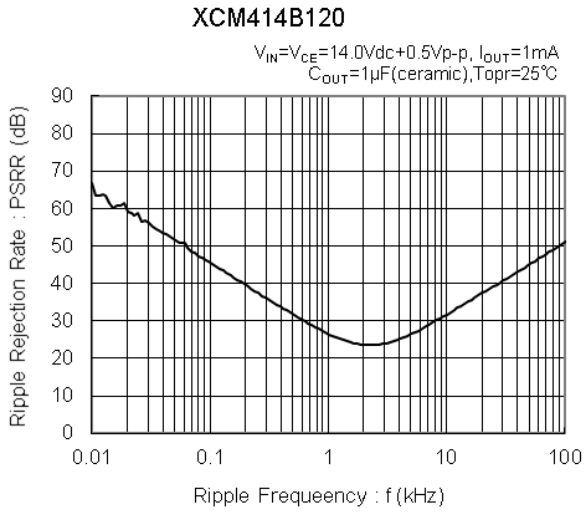

TYPICAL PERFORMANCE CHARACTERISTICS (Continued)

● Schottky Barrier Diodes (SBD)

(1) Forward Current vs. Forward Voltage

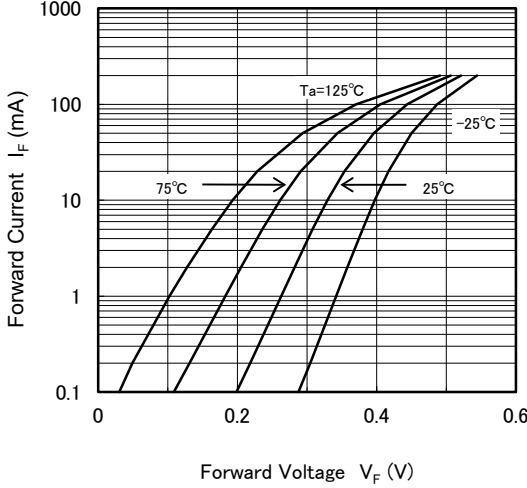

(2) Reverse Current vs. Reverse Voltage

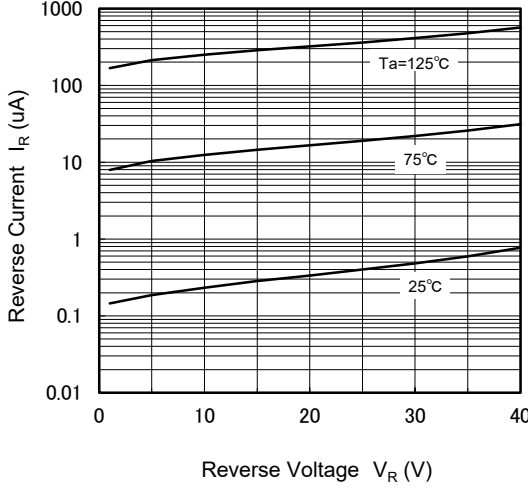

(3) Forward Voltage vs. Operating Temperature

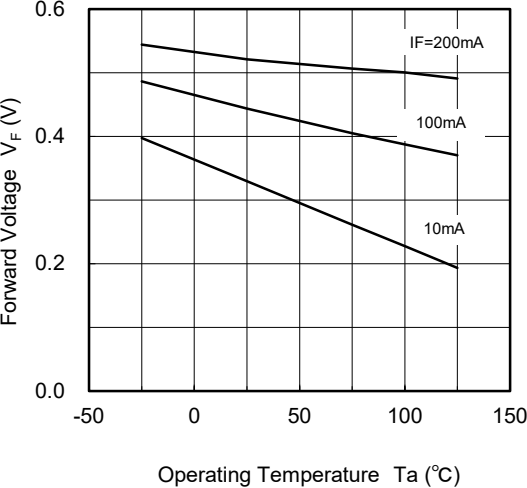

(4) Reverse Current vs. Operating Temperature

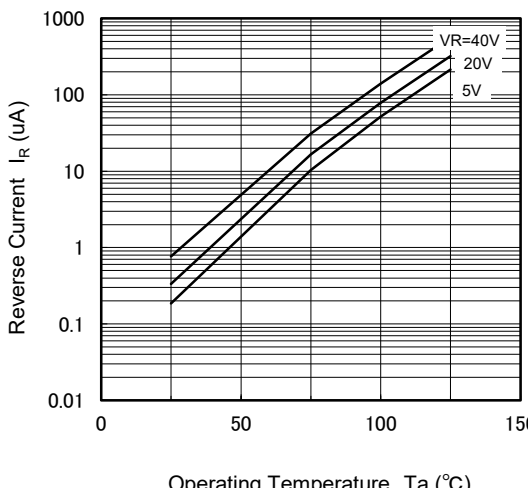

(5) Inter-Terminal Capacity vs. Reverse Voltage

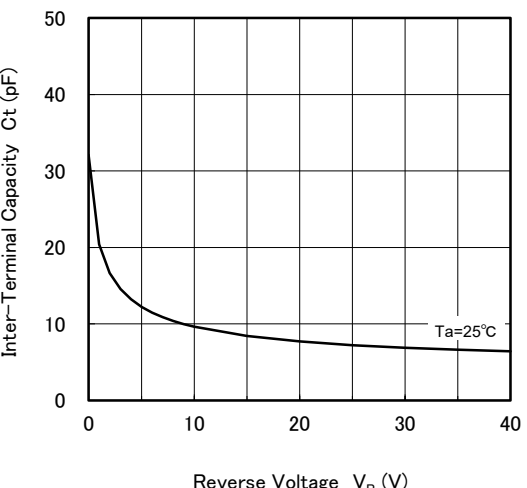

(6) Average Forward Current vs. Operating Temperature

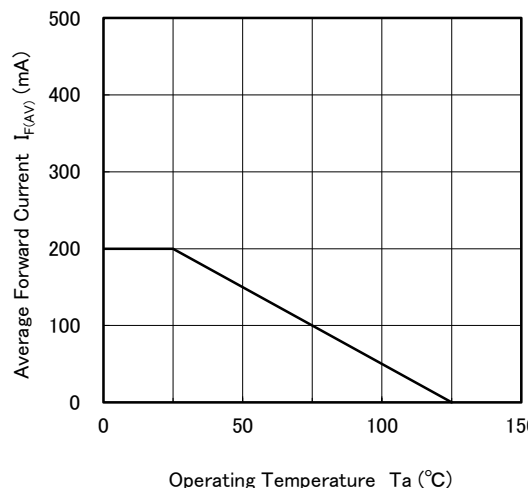

■ PACKAGING INFORMATION

For the latest package information go to, www.torexsemi.com/technical-support/packages

PACKAGE	OUTLINE / LAND PATTERN	THERMAL CHARACTERISTICS	
USP-8B10	USP-8B10 PKG	High heat dissipation Board	USP-8B10 Power Dissipation

MARKING RULE

① represents product series.

MARK	PRODUCT SERIES
4	XCM414Bxxxxx-G

② represents Integer part of the output voltage range.

MARK	Voltage (V)	MARK	Voltage (V)
2	2.X	8	8.X
3	3.X	9	9.X
4	4.X	A	10.X
5	5.X	B	11.X
6	6.X	C	12.X
7	7.X		

③ represents first digit of decimal point of output voltage range.

MARK	Voltage (V)	MARK	Voltage (V)
0	X.0	5	X.5
1	X.1	6	X.6
2	X.2	7	X.7
3	X.3	8	X.8
4	X.4	9	X.9

④⑤ represents production lot number.
 01 to 09, 0A to 0Z, A1 to A9, AA to AZ, B1 to ZZ repeated
 * G, I, J, O, Q, W excluded
 * No character inversion used.

USP-8B10

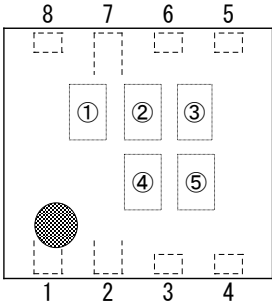

1. The product and product specifications contained herein are subject to change without notice to improve performance characteristics. Consult us, or our representatives before use, to confirm that the information in this datasheet is up to date.
2. The information in this datasheet is intended to illustrate the operation and characteristics of our products. We neither make warranties or representations with respect to the accuracy or completeness of the information contained in this datasheet nor grant any license to any intellectual property rights of ours or any third party concerning with the information in this datasheet.
3. Applicable export control laws and regulations should be complied and the procedures required by such laws and regulations should also be followed, when the product or any information contained in this datasheet is exported.
4. The product is neither intended nor warranted for use in equipment of systems which require extremely high levels of quality and/or reliability and/or a malfunction or failure which may cause loss of human life, bodily injury, serious property damage including but not limited to devices or equipment used in 1) nuclear facilities, 2) aerospace industry, 3) medical facilities, 4) automobile industry and other transportation industry and 5) safety devices and safety equipment to control combustions and explosions. Do not use the product for the above use unless agreed by us in writing in advance.
5. Although we make continuous efforts to improve the quality and reliability of our products; nevertheless Semiconductors are likely to fail with a certain probability. So in order to prevent personal injury and/or property damage resulting from such failure, customers are required to incorporate adequate safety measures in their designs, such as system fail safes, redundancy and fire prevention features.
6. Our products are not designed to be Radiation-resistant.
7. Please use the product listed in this datasheet within the specified ranges.
8. We assume no responsibility for damage or loss due to abnormal use.
9. All rights reserved. No part of this datasheet may be copied or reproduced unless agreed by Torex Semiconductor Ltd in writing in advance.

TOREX SEMICONDUCTOR LTD.

X-ON Electronics

Largest Supplier of Electrical and Electronic Components

Click to view similar products for [Linear Voltage Regulators](#) category:

Click to view products by [Torex Semiconductor](#) manufacturer:

Other Similar products are found below :

[LV56831P-E](#) [LV5684PVD-XH](#) [MCDTSA6-2R](#) [L7815ACV-DG](#) [LV56801P-E](#) [TCR3DF13,LM\(CT](#) [TCR3DF39,LM\(CT](#) [TLE42794G](#)
[L78L05CZ/1SX](#) [L78LR05DL-MA-E](#) [LM317T](#) [636416C](#) [714954EB](#) [BA033LBSG2-TR](#) [LV5680P-E](#) [L78M15CV-DG](#) [L79M05T-E](#)
[TLS202A1MBVHTSA1](#) [L78LR05D-MA-E](#) [NCV317MBTG](#) [NTE7227](#) [KIA7810AF-RTF/P](#) [LV5680NPVC-XH](#) [VRD3333PLX](#)
[VRH2501NLX](#) [VRD1533MLX](#) [VRD2828PNX](#) [VRD3033PLX](#) [VRH1502LLX](#) [VRD2530PLX](#) [VRD1233MLX](#) [VRH2801NNX](#)
[VRD1830MLX](#) [ME6208A50M3G](#) [ME6231A50M3G](#) [ME6231A50PG](#) [ME6231C50M5G](#) [AMS1117S-3.3](#) [AMS1117-5.0](#) [AMS1117S-5.0](#)
[AMS1117-3.3](#) [MD5118](#) [MD5128](#) [MD5130](#) [MD5150](#) [MD5112](#) [MD5115](#) [MD5136](#) [MD5140](#) [MD52E18WB6](#)