

TOSHIBA PHOTOCOUPLER GaAs IRED & PHOTO-TRANSISTOR

4N29(Short), 4N29A(Short), 4N30(Short), 4N31(Short) 4N32(Short), 4N32A(Short), 4N33(Short)

- AC LINE / DIGITAL LOGIC ISOLATOR.
- DIGITAL LOGIC/DIGITAL LOGIC ISOLATOR.
- TELEPHONE LINE RECEIVER.
- TWISTED PAIR LINE RECEIVER.
- RELAY CONTACT MONITOR.

The TOSHIBA 4N29 (Short) through 4N33 (Short) consists arsenide infrared emitting diode coupled with a silicon photo darlington in a dual in-line package.

- Switching Time : 100 μ s (Max.)
- DC Current Transfer Ratio : 500%
- Isolation Resistance : 10¹¹ Ω (Typ.)
- Isolation Voltage : 2500V_{rms} (Min.)
- UL Recognized : UL1577, File No. E67349

Unit in mm

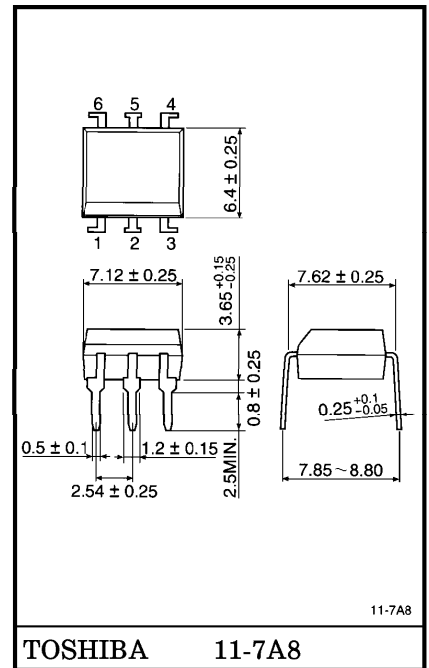

Weight : 0.4g

PIN CONFIGURATIONS (Top view)

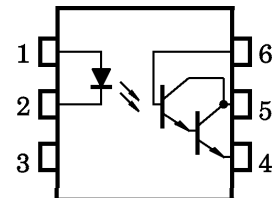

- 1 : ANODE
- 2 : CATHODE
- 3 : N.C.
- 4 : EMITTER
- 5 : COLLECTOR
- 6 : BASE

MAXIMUM RATINGS (Ta = 25°C)

CHARACTERISTIC		SYMBOL	RATING	UNIT
LED	Forward Current (Continuous)	I _F	80	mA
	Forward Current Derating	ΔI _F / °C	1.07(*)	mA / °C
	Peak Forward Current (Note 1)	I _{PF}	3	A
	Power Dissipation	P _D	150	mW
	Power Dissipation Derating	ΔP _D / °C	2.0(*)	mW / °C
	Reverse Voltage	V _R	3	V
DETECTOR	Collector-Emitter Voltage	BV _{CEO}	30	V
	Collector-Base Voltage	BV _{CBO}	30	V
	Emitter-Collector Voltage	BV _{ECO}	5	V
	Collector Current (Continuous)	I _C	100	mA
	Power Dissipation	P _C	150	mW
	Power Dissipation Derating	ΔP _C / °C	2.0(*)	mW / °C
COUPLED	Storage Temperature Range	T _{stg}	-55~150	°C
	Operating Temperature Range	T _{opr}	-55~100	°C
	Lead Soldering Temperature	T _{sol}	260	°C
	Total Package Power Dissipation	P _T	250	mW
	Total Package Power Dissipation Derating	ΔP _T / °C	3.3(*)	mW / °C

(Note 1) Pulse width 300μs, 2% duty cycle.

(*) Above 25°C ambient.

ELECTRICAL CHARACTERISTICS (Ta = 25°C)

CHARACTERISTIC		SYMBOL	TEST CONDITION	MIN.	TYP.	MAX.	UNIT	
LED	Forward Voltage	V_F	$I_F = 10\text{mA}$	—	1.15	1.5	V	
	Reverse Current	I_R	$V_R = 3\text{V}$	—	—	100	μA	
	Capacitance	C_D	$V = 0, f = 1\text{MHz}$	—	30	—	pF	
DETECTOR	DC Forward Current Gain	h_{FE}	$V_{CE} = 5, I_C = 0.5\text{mA}$	—	10k	—	—	
	Collector-Emitter Breakdown Voltage	$V_{(BR)CEO}$	$I_C = 1\text{mA}$	30	—	—	V	
	Collector-Base Breakdown Voltage	$V_{(BR)CBO}$	$I_C = 100\mu\text{A}$	30	—	—	V	
	Emitter-Collector Breakdown Voltage	$V_{(BR)ECO}$	$I_E = 100\mu\text{A}$	5	—	—	V	
Collector Dark Current		I_{CEO}	$V_{CE} = 10\text{V}$	—	1.0	100	nA	
COUPLED	Collector Output Current	4N32, 4N32A 4N33	$I_F = 10\text{mA}, V_{CE} = 10\text{V}$	50	—	—	mA	
		4N29, 4N29A 4N30		10	—	—		
		4N31		5	—	—		
	Collector-Emitter Saturation Voltage	4N29, 4N29A 4N30, 4N32 4N32A, 4N33	$V_{CE(sat)}$	$I_F = 8\text{mA}, I_C = 2\text{mA}$	—	—	1.0	V
		4N31			—	—	1.2	
	Turn-on Time		t_{ON}	$I_F = 200\text{mA}, V_{CC} = 10\text{V}$ $I_C = 50\text{mA}$	—	—	5	μs
	Turn-off Time	4N29, 4N29A 4N30, 4N31	t_{OFF}		—	—	40	μs
		4N32, 4N32A 4N33					100	
	Capacitance Input to Output		C_S	$V = 0, f = 1\text{MHz}$	—	0.8	—	pF
	Isolation Resistance		R_S	$V = 500\text{V}$	—	10^{11}	—	Ω
Isolation Voltage			BV_S	$\text{AC}, 1 \text{ minute R. H.} \leq 60\%$		2500	V_{rms}	
	4N29, 4N29A 4N32, 4N32A	$BV_S (*)$	AC, peak	2500	—	—	V_{pk}	
				1500	—	—		
	4N30, 4N31 4N33		AC, 1 second	1775	—	—	V_{rms}	
4N29A, 4N32A								

(*) JEDEC registered minimum BV_S , however, Toshiba specifies a minimum BV_S of $2500V_{rms}$ 1 minute.

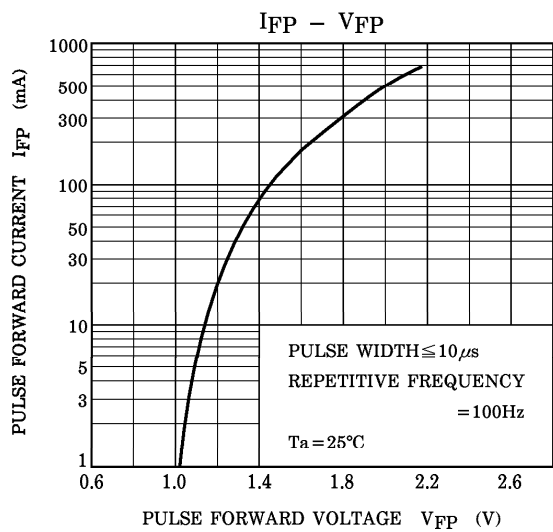
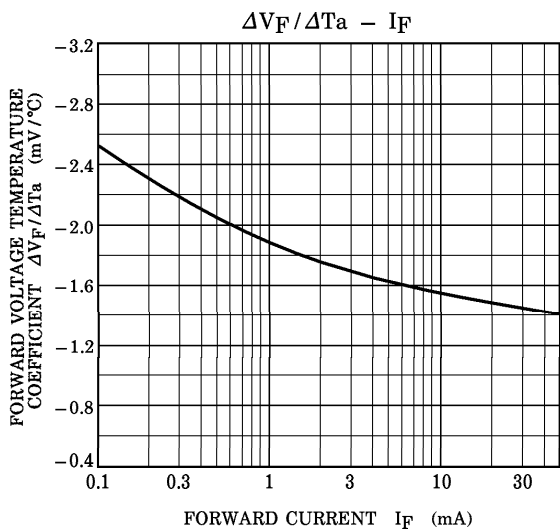
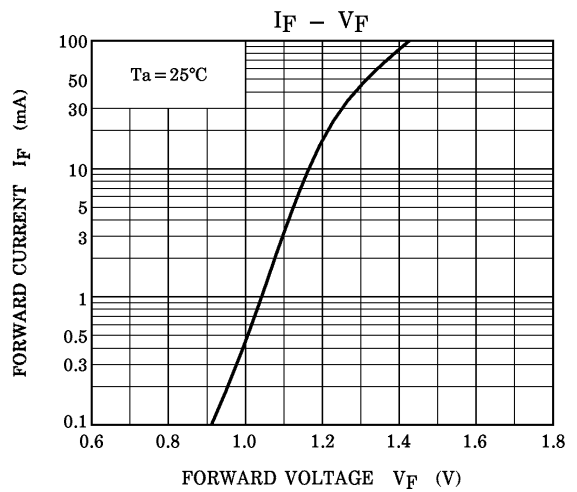
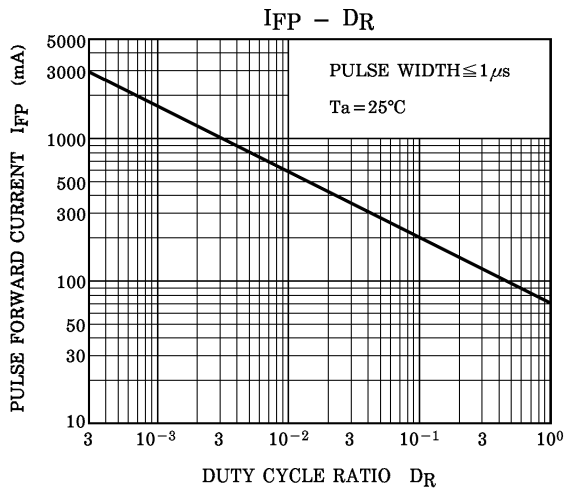
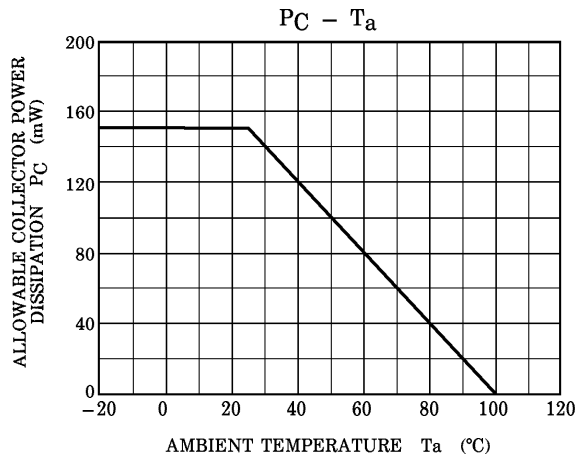
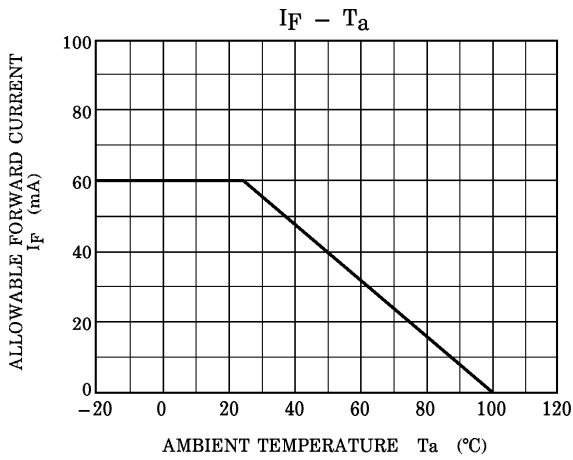

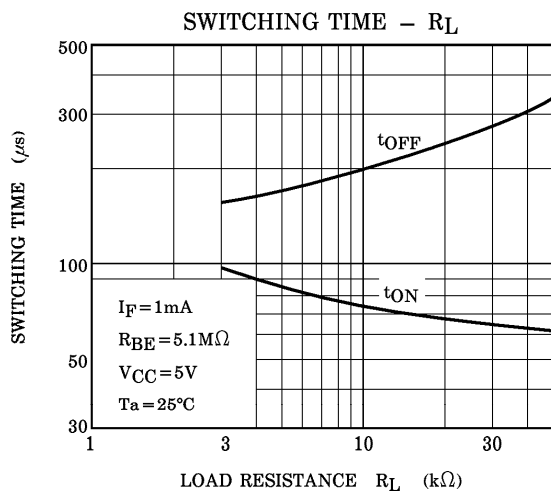
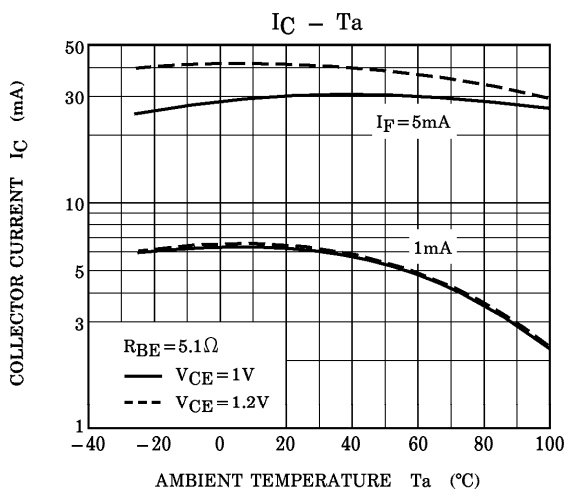
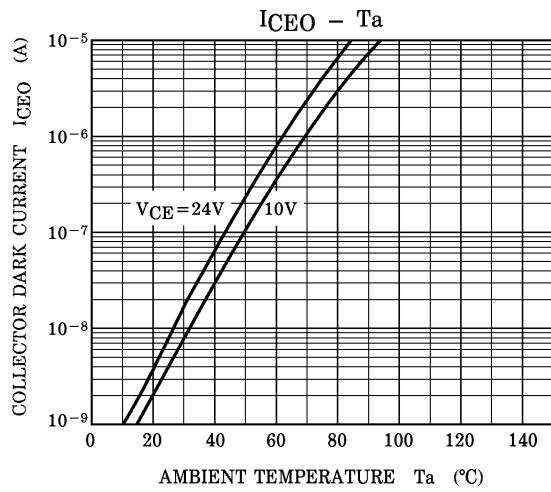
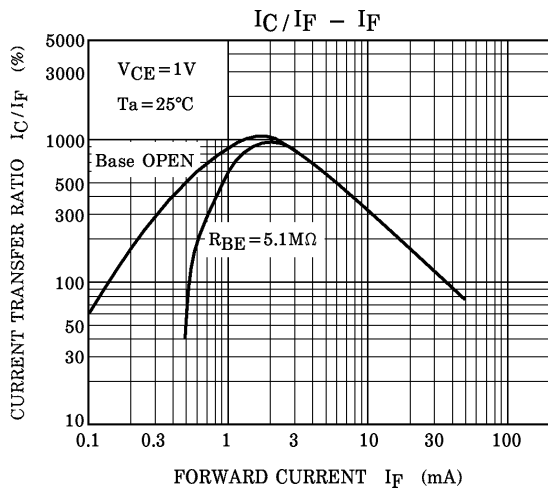
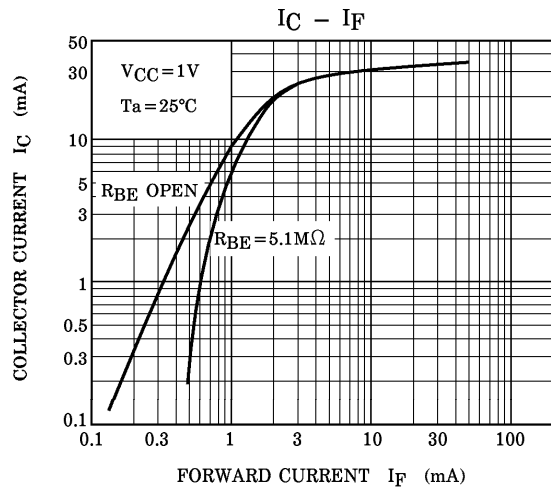
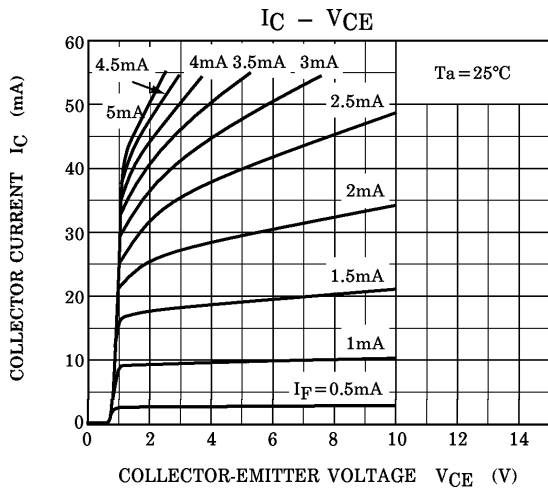

RESTRICTIONS ON PRODUCT USE

000707EBC

- TOSHIBA is continually working to improve the quality and reliability of its products. Nevertheless, semiconductor devices in general can malfunction or fail due to their inherent electrical sensitivity and vulnerability to physical stress. It is the responsibility of the buyer, when utilizing TOSHIBA products, to comply with the standards of safety in making a safe design for the entire system, and to avoid situations in which a malfunction or failure of such TOSHIBA products could cause loss of human life, bodily injury or damage to property. In developing your designs, please ensure that TOSHIBA products are used within specified operating ranges as set forth in the most recent TOSHIBA products specifications. Also, please keep in mind the precautions and conditions set forth in the "Handling Guide for Semiconductor Devices," or "TOSHIBA Semiconductor Reliability Handbook" etc..
- The TOSHIBA products listed in this document are intended for usage in general electronics applications (computer, personal equipment, office equipment, measuring equipment, industrial robotics, domestic appliances, etc.). These TOSHIBA products are neither intended nor warranted for usage in equipment that requires extraordinarily high quality and/or reliability or a malfunction or failure of which may cause loss of human life or bodily injury ("Unintended Usage"). Unintended Usage include atomic energy control instruments, airplane or spaceship instruments, transportation instruments, traffic signal instruments, combustion control instruments, medical instruments, all types of safety devices, etc.. Unintended Usage of TOSHIBA products listed in this document shall be made at the customer's own risk.
- Gallium arsenide (GaAs) is a substance used in the products described in this document. GaAs dust and fumes are toxic. Do not break, cut or pulverize the product, or use chemicals to dissolve them. When disposing of the products, follow the appropriate regulations. Do not dispose of the products with other industrial waste or with domestic garbage.
- The products described in this document are subject to the foreign exchange and foreign trade laws.
- The information contained herein is presented only as a guide for the applications of our products. No responsibility is assumed by TOSHIBA CORPORATION for any infringements of intellectual property or other rights of the third parties which may result from its use. No license is granted by implication or otherwise under any intellectual property or other rights of TOSHIBA CORPORATION or others.
- The information contained herein is subject to change without notice.

X-ON Electronics

Largest Supplier of Electrical and Electronic Components

Click to view similar products for [Transistor Output Optocouplers](#) category:

Click to view products by [Toshiba](#) manufacturer:

Other Similar products are found below :

[LTV-814S-TA](#) [LTV-815S-TA](#) [LTV-8241S](#) [LTV-824HS](#) [LTV-852S](#) [66095-001](#) [6N136-X017T](#) [6N136-X019T](#) [MCT6-X007](#) [MCT6-X007T](#)
[MOC8101-X009](#) [MOC8101-X017T](#) [PS2561-1-A](#) [PS2561A-1-W-A](#) [PS2561B-1-L-A](#) [PS2561DL-1Y-V-A](#) [PS2561L1-1-A](#) [PS2561L-1-V-A](#)
[PS2581AL2-A](#) [PS2706-1-A](#) [PS2815-1-A](#) [MRF658](#) [ELD207\(TA\)](#) [IL755-1X007](#) [IL755-2](#) [ILD2-X006](#) [ILD74-X001](#) [ILQ615-2X017](#) [ILQ615-3X016](#) [LDA102S](#) [LDA110S](#) [LDA202](#) [SFH601-4X007T](#) [SFH615A-2X009T](#) [SFH615A-4X001](#) [SFH615AGR-X007T](#) [SFH618A-3X006](#)
[SFH620A-2X007](#) [SFH690BT3](#) [PS2561-1-V-W-A](#) [PS2561A-1-V-A](#) [PS2561AL1-1-V-A](#) [PS2561AL-1-H-A](#) [PS2561AL-1-V-A](#) [PS2561BL-1-F3-Q-A](#) [PS2561DL-1Y-F3-A](#) [PS2561L1-1-L-A](#) [PS2561L1-1-V-Q-A](#) [PS2562-1-V-A](#) [PS2565L-1-A](#)