

Small and Medium Diodes



Small and Medium Diodes

Recently, many products ranging from computers and home appliances to automobiles and industrial equipment have been driving the need for effective solutions to reduce size and weight. Semiconductor requirements differ from application to application. Take power supplies for example, which are being required to accommodate higher capacity in smaller dimensions. This increases the temperature at which systems are operated.

To meet these requirements, Toshiba offers an extensive portfolio of small, high-efficiency diodes, including Schottky barrier diodes (SBDs) featuring high-speed operation and low forward loss.

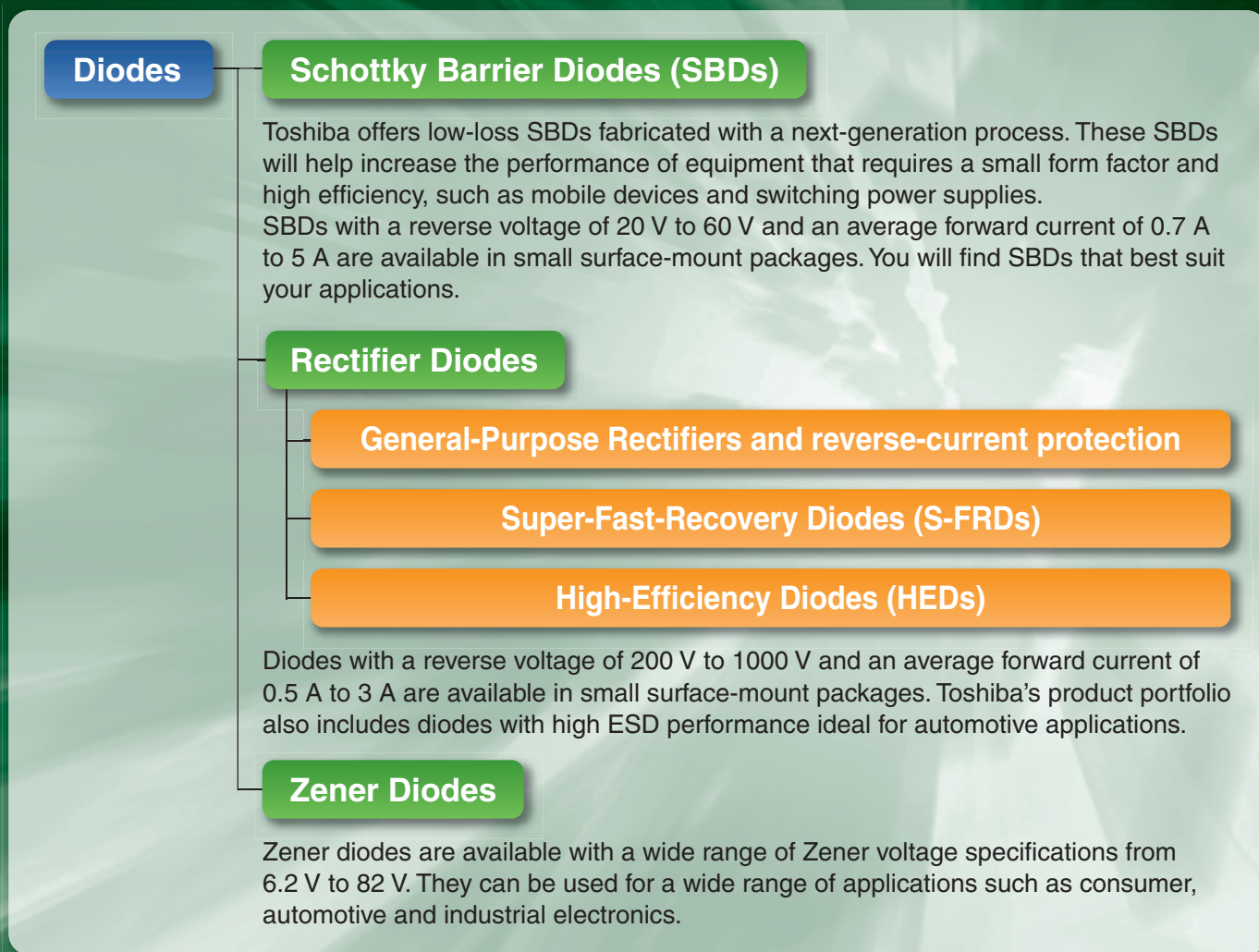

CONTENTS

- Product Lines 2
- Product Lineup 3
- [Product Descriptions]
 - Schottky Barrier Diodes (SBDs) 4
 - Rectifier Diodes 6
 - Zener Diodes 8
- [Product Lineup] 10
 - Device Marking 13

This brochure contains information on small and medium diodes only. For switching diodes, small-signal Schottky barrier diodes and ESD protection diodes, see the following brochure or our homepage:

- ◆ Homepage <http://toshiba.semicon-storage.com/>
- ◆ Brochure Discrete Semiconductors, Linear ICs, Logic ICs

Product Lineup

SMALL & MEDIUM DIODES

Surface-Mount Package Trend for Diodes

In order to help improve the performance of information and communications equipment, Toshiba offers high-efficiency diodes in small surface-mount packages.

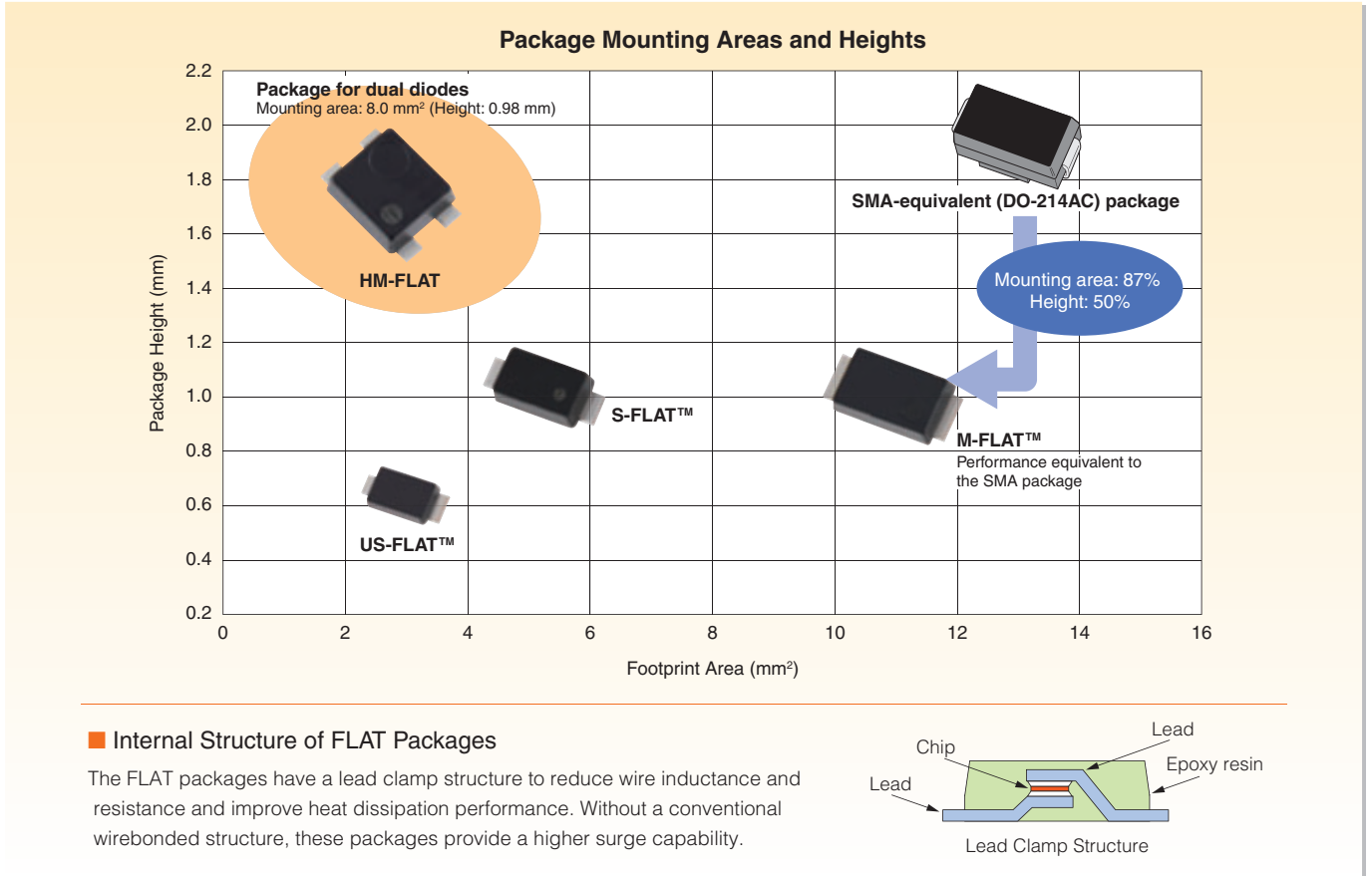

FLAT Package Series

US-FLAT™

Ultra Small Flat Package

Typical product: CUS01, CUS10I30A

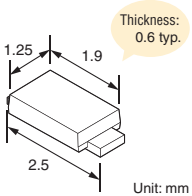

S-FLAT™

Small Flat Package

Typical product: CRS01, CRS10I30A

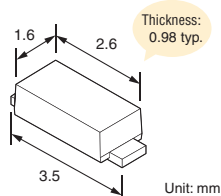

M-FLAT™

Middle Flat Package

Typical product: CMS01, CMS10I30A

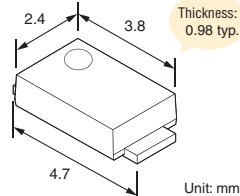

HM-FLAT

Hybrid Middle Flat Package

Typical product: HMG02

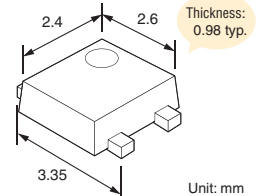

Recommended PCB land pattern dimensions (Unit: mm)

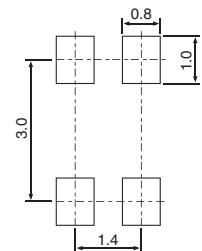
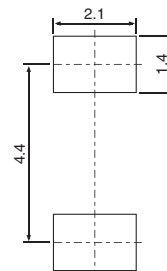
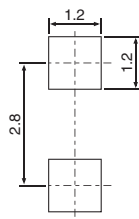
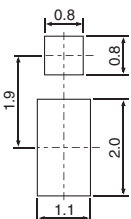

Note: The PCB land pattern dimensions shown above are for reference only and should be determined empirically.

Schottky Barrier Diodes (SBDs)

▶ SMALL & MEDIUM DIODES

Schottky barrier diodes (SBDs) have a junction formed between a semiconductor and a metal such as molybdenum, instead of a PN junction. Unlike PN junction diodes, SBDs are majority carrier devices. Therefore, SBDs feature low forward voltage and short reverse recovery time, making them ideal for high-speed switching applications.

Toshiba offers SBDs fabricated using a new process that provides an improved V_F - I_{RRM} trade-off. These new SBDs, together with conventional SBDs, will meet diverse design requirements.

Schottky-Barrier Diodes (SBDs) with Improved Trade-Off

Toshiba now offers small to medium SBDs fabricated with a new process. Owing to low peak forward voltage (V_{FM}) and low repetitive peak reverse current (I_{RRM}) characteristics, these SBDs provide low power loss and thus help reduce the size and improve the power efficiency of mobile handsets, switching power supplies, etc.

- ▶ Voltage rating: $V_{RRM} = 30\text{ V}, 40\text{ V}$
- ▶ Current rating: $I_{F(AV)} = 1\text{ A to } 3\text{ A}$
- ▶ Peak forward voltage (Typical characteristics: CRS10I30A)
 - $V_{FM} = 0.35\text{ V typ.}$
 - $0.39\text{ V max (@ } I_{FM} = 0.7\text{ A)}$
- ▶ Small surface-mount packages (US-FLAT™/S-FLAT™/M-FLAT™)

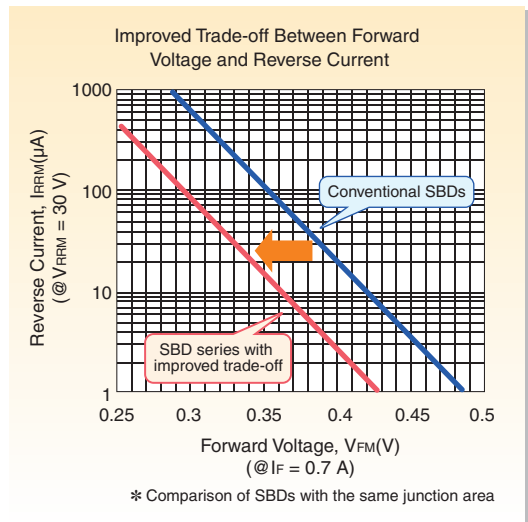

Application Example: Notebook PC

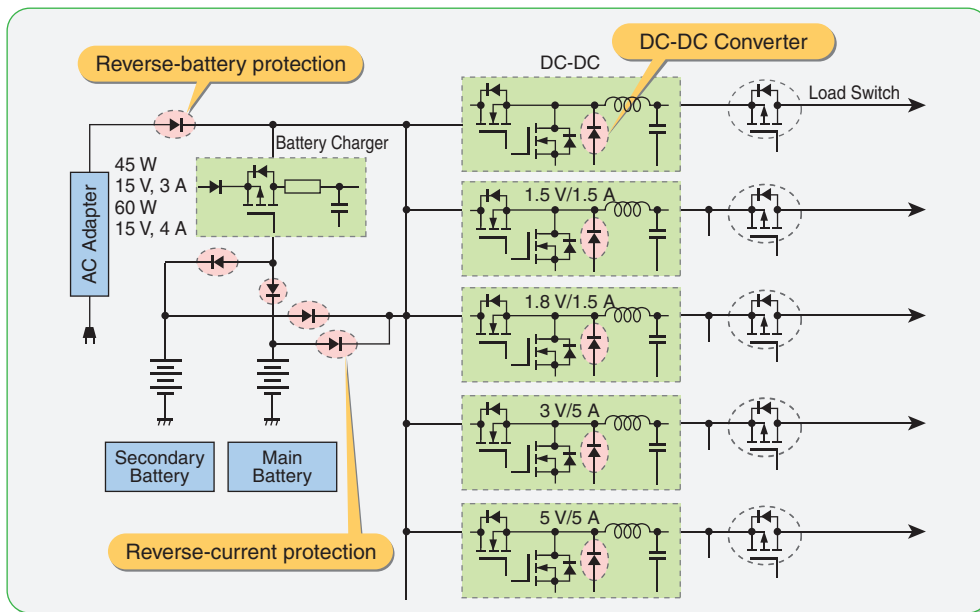

Applications	Package	Recommended Diodes
Reverse-battery and reverse-current protection	US-FLAT™	CUS01, CUS02, CUS10I30A, CUS15I30A
	S-FLAT™	CRS01, CRS03, CRS05, CRS06, CRS08, CRS09, CRS11, CRS14
	M-FLAT™	CMS01, CMS03, CMS06, CMS07, CMS08, CMS09, CMS16
DC-DC converters	S-FLAT™	CRS03, CRS04, CRS05, CRS09, CRS13, CRS10I30A, CRS15I30A, CRS20I30A
	M-FLAT™	CMS03, CMS05, CMS14, CMS15, CMS20I30A, CMS30I30A, CMS20I40A, CMS30I40A

Product Selection Guide

See page 10 for electrical specifications.

Average Forward Current, $I_{F(AV)}$	Package	Repetitive Peak Reverse Voltage, V_{RRM}			
		20 V	30 V	40 V	60 V
0.7 A	US-FLAT™			CUS03	CUS04
1 A	US-FLAT™	CUS05 CUS06	CUS01 CUS02 CUS10I30A	CUS10I40A	
	S-FLAT™	CRS06	CRS01 CRS03 CRS05 CRS11 CRS10I30A CRS10I30B CRS10I30C	CRS04 CRS10I40A CRS10I40B	CRS12 CRS13
	M-FLAT™		CMS08 CMS09 CMS10I30A	CMS10 CMS10I40A	
1.5 A	US-FLAT™		CUS15I30A		
	S-FLAT™		CRS08 CRS09 CRS15I30A CRS15I30B	CRS15I40A	
	M-FLAT™			CMS15I40A	
2 A	S-FLAT™		CRS14 CRS20I30A CRS20I30B	CRS20I40A CRS20I40B	
	M-FLAT™		CMS06 CMS07 CMS17 CMS20I30A	CMS11 CMS20I40A	CMS14
3 A	S-FLAT™		CRS15◇ CRS30I30A		
	M-FLAT™		CMS01 CMS03 CMS30I30A	CMS16 CMS30I40A	CMS15
5 A	M-FLAT™		CMS04 CMS05		

◇: $I_{F(DC)} = 3 A$

Part Naming Conventions

SBDs with improved trade-offs

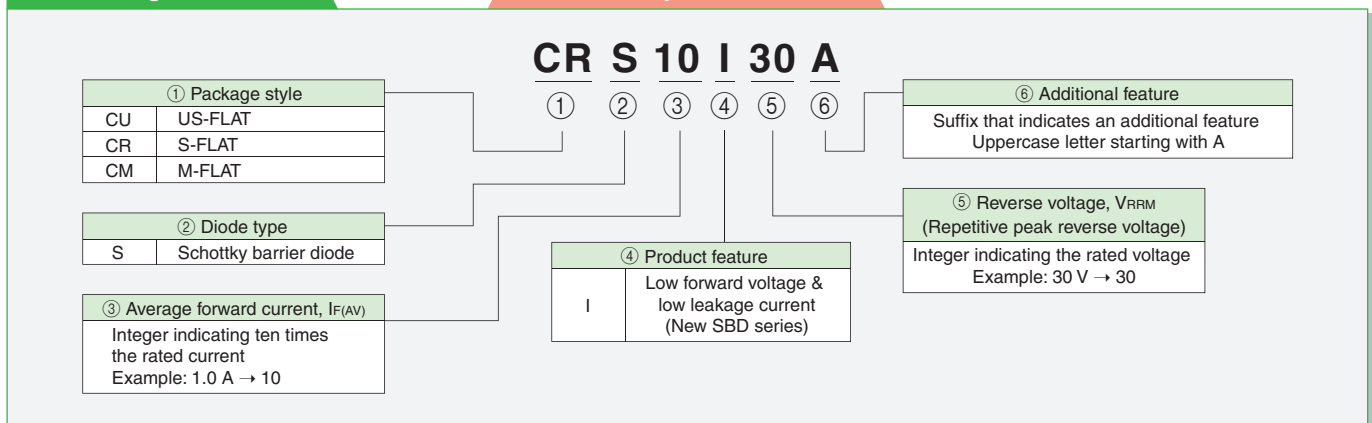

Part Naming Conventions

Conventional SBDs

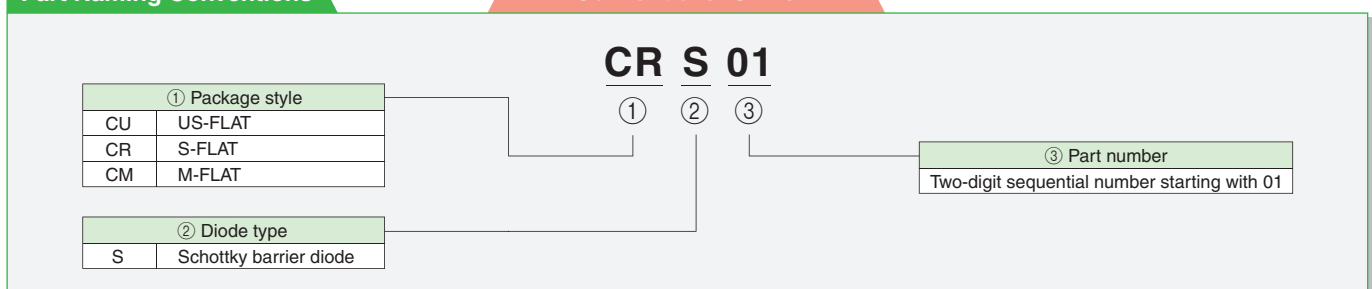

Rectification Diodes

SMALL & MEDIUM DIODES

Toshiba offers rectification diodes in surface-mount packages with a reverse voltage ranging from 200 V to 1000 V and an average forward current ranging from 0.5 A to 3 A.

Toshiba's product portfolio of General-Purpose Rectifiers (for reverse-current protection) includes diodes with high ESD tolerance and dual diode devices suitable for automotive applications. Super-Fast Recovery Diodes (S-FRDs) are available in small, thin packages with a V_{RRM} of up to 1000 V. High-Efficiency Diodes (HEDs) provide a short reverse recovery time of 35 ns or less.

Product Lines

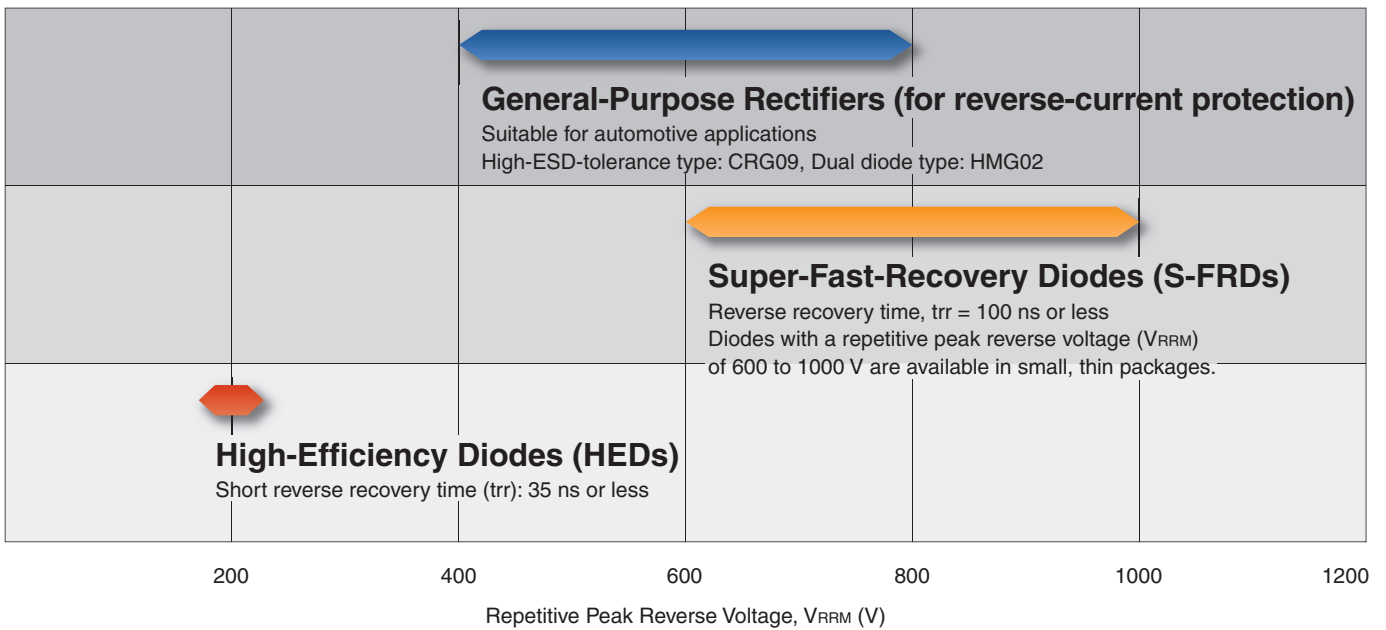

Application Example: Automobiles

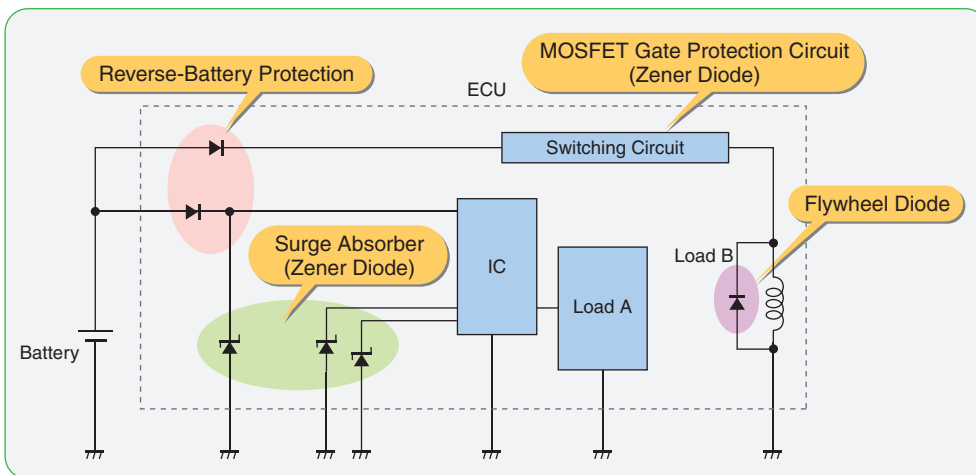

Applications	Package	Recommended Diodes
Reverse-battery and reverse-current protection	S-FLAT™	CRG04, CRG05, CRG07, CRG09, CRG03, HMG02
	M-FLAT™	CMG02, CMG03, CMG05, CMG06, CMG07, CMG08
Flywheeling	S-FLAT™	CRH01, CRH02
	M-FLAT™	CMH01, CMH04, CMH07

* See "Zener Diodes" on pages 8-9 for a description of diodes for MOSFET gate protection and surge absorber applications.

Product Selection Guide

► General-Purpose Rectifiers (for reverse-current protection)

See page 11 for electrical specifications.

Average Forward Current, $I_{F(AV)}$	Package	Repetitive Peak Reverse Voltage, V_{RRM}		
		400 V	600 V	800 V
0.7 A	HM-FLAT	HMG02 ⁽¹⁾		
	S-FLAT™	CRG07		
1 A	S-FLAT™	CRG03	CRG04	CRG05
		CRG09 ⁽²⁾		
	M-FLAT™	CMC02 ⁽³⁾	CMG06 CMG08	
2 A	M-FLAT™	CMG05 CMG07	CMG03	
		CMG02		

(1) Dual diodes (two separate diodes)

(2) High ESD protection

(3) Designed for strobe discharge applications.

► Super-Fast-Recovery Diodes (S-FRDs)

Average Forward Current, $I_{F(AV)}$	Package	Reverse Recovery Time, t_{rr} (Max)	Repetitive Peak Reverse Voltage, V_{RRM}			
			600 V	800 V	900 V	1000 V
0.5 A	S-FLAT™	100 ns		CRF02		
	M-FLAT™			CMF04	CMF03	CMF05
0.7 A	S-FLAT™		CRF03			
1 A	M-FLAT™		CMF02			
2 A	M-FLAT™		CMF01			

► High-Efficiency Diodes (HEDs)

Average Forward Current, $I_{F(AV)}$	Package	Reverse Recovery Time, t_{rr} (Max)	Repetitive Peak Reverse Voltage, V_{RRM}			
			200 V			
0.5 A	S-FLAT™	35 ns		CRH02		
1 A	S-FLAT™		CRH01			
	M-FLAT™		CMH04			
2 A	M-FLAT™		CMH07			
3 A	M-FLAT™		CMH01			

Part Naming Conventions

CR G 03

① Package style	
CR	S-FLAT
CM	M-FLAT
HM	HM-FLAT

② Diode type	
G	General-Purpose Rectifiers
F	Super-fast-recovery diodes (S-FRDs)
H	High-efficiency diodes (HEDs)
C	For strobe flash dischargers

③ Part number
Two-digit sequential number starting with 01

Zener Diodes

SMALL & MEDIUM DIODES

Recent electronic circuits generally incorporate microcontrollers and memory chips to provide complicated control functions. High-precision voltage regulation is required to drive these advanced devices. To address this need, Toshiba offers Zener diodes for constant-voltage regulation for a wide range of input voltage from 6.2 V to 82 V. Zener diodes can also be used for circuit protection purposes such as surge absorption and noise limiting. They are suitable for a broad spectrum of applications, including commercial, automotive and industrial equipment.

Features

Toshiba offers Zener diodes in small, thin packages with a power dissipation of 0.7 W to 2 W featuring a high current surge capability.

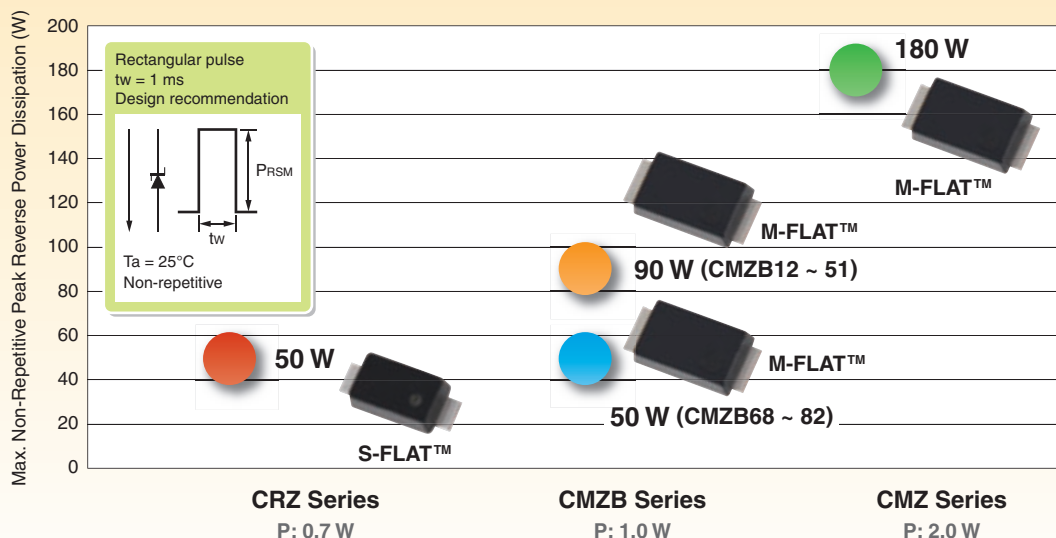

Design Recommendation for Maximum Non-Repetitive Peak Reverse Power Dissipation (Pulse Width, $t_w = 1$ ms)

Basic Circuit Example

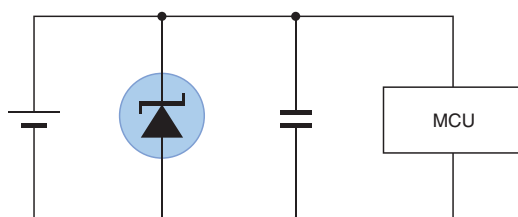

Microcontroller Unit (MCU) Protection

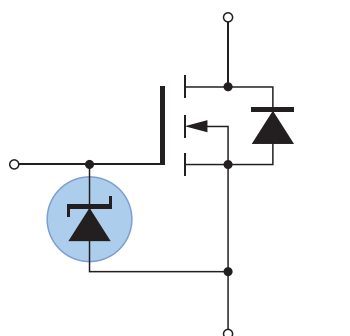

MOSFET Gate Protection

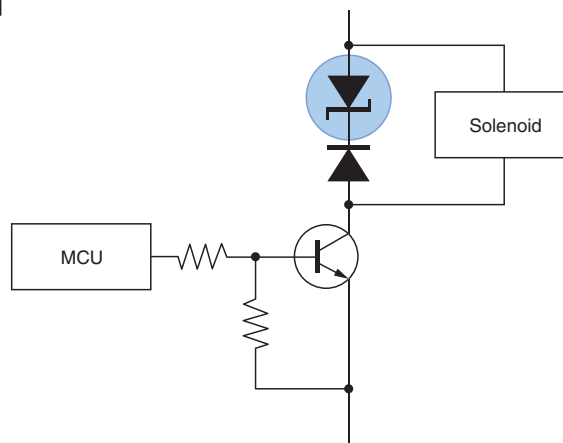

Solenoid Protection (Surge Absorber)

Power Dissipation	0.7 W	1.0 W	2.0 W
Zener Voltage Vz(V) typ.	S-FLAT™	M-FLAT™	
6.2	CRY62		
6.8	CRY68		
8.2	CRY82		
10	CRZ10		
12	CRZ12	CMZB12	CMZ12
13	CRZ13	CMZB13	CMZ13
15	CRZ15	CMZB15	CMZ15
16	CRZ16		
18	CRZ18	CMZB18	CMZ18
20	CRZ20	CMZB20	CMZ20
24	CRZ24	CMZB24	CMZ24
27	CRZ27	CMZB27	CMZ27
30	CRZ30	CMZB30	CMZ30
33	CRZ33	CMZB33	CMZ33
36	CRZ36	CMZB36	CMZ36
39	CRZ39	CMZB39	CMZ39
43		CMZB43	CMZ43
47		CMZB47	CMZ47
51		CMZB51	CMZ51
68		CMZB68	
75		CMZB75	
82		CMZB82	

The Zener voltage values listed above are the values measured at the specified Zener current (Iz). For Zener voltage measurement, a pulse measurement method is used to minimize the increase in diode temperature. Therefore, Zener voltage could be different, depending on the actual usage conditions and Zener current. Temperature changes and variations should also be considered. When Zener voltage starts to rise (i.e., while Zener current is still low), a Zener diode has a large dynamic resistance (rd), causing significant variations in Zener voltage. For voltage regulation purposes, it is desirable to use a Zener diode in a low dynamic resistance region where sufficient Zener current flows.

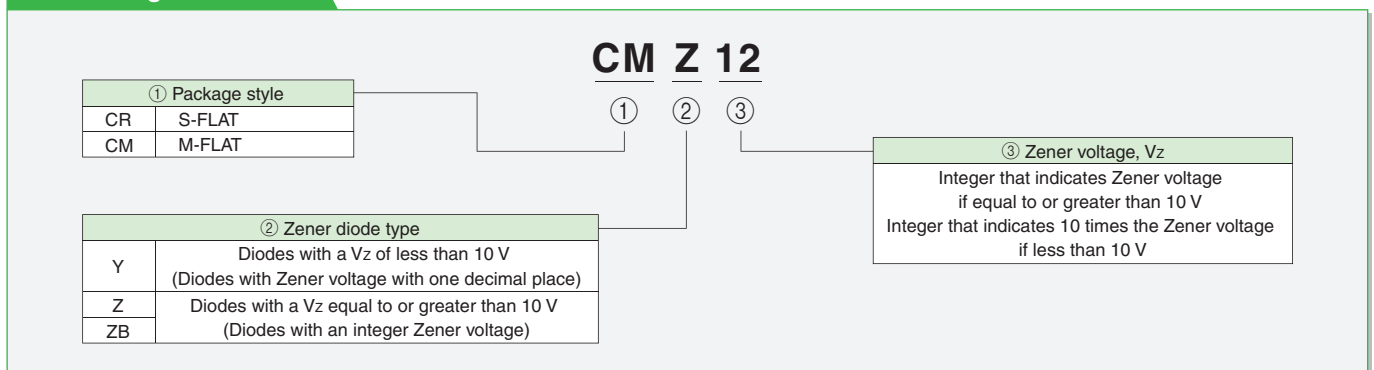

Part Naming Conventions



Rectification Diodes

► General-Purpose Rectifiers (for reverse-current protection)

(Ta = 25°C)

	Package	Part Number	Absolute Maximum Ratings					Electrical Characteristics (Max)		
			V _{RRM} (V)	I _{F(AV)} (A)	I _{FSM} (A)	T _j (°C)	T _{stg} (°C)	I _{RRM} (μA)	V _{FM} (V)	@ I _{FM} (A)
Single	 S-FLAT™	CRG07	400	0.7	15	175	-40 to 175	10	1.1	0.7
		CRG03	400	1.0	15	150	-40 to 150	10	1.1	0.7
		CRG09 ⁽¹⁾	400	1.0	15	150	-40 to 150	10	1.1	0.7
		CRG04	600	1.0	15	150	-40 to 150	10	1.1	1.0
		CRG05	800	1.0	15	150	-40 to 150	10	1.2	1.0
	 M-FLAT™	CMC02 ⁽²⁾	400	1.0	30	150	-40 to 150	10	1.0	1.0
		CMG05	400	1.0	15	150	-40 to 150	10	1.1	1.0
		CMG07	400	1.0	30	150	-40 to 150	10	1.1	1.0
		CMG02	400	2.0	80	150	-40 to 150	10	1.1	2.0
		CMG06	600	1.0	15	150	-40 to 150	10	1.1	1.0
Dual	 HM-FLAT	CMG08	600	1.0	30	150	-40 to 150	10	1.1	1.0
		CMG03	600	2.0	80	150	-40 to 150	10	1.1	2.0
		HMG02 ⁽³⁾	400	0.7	10	175	-40 to 175	10	1.0	0.5

(1) High ESD protection

(2) Designed for strobe discharge applications

(3) I_{F(AV)}, I_{FSM}, I_{RRM} and V_{FM} are specified per diode.

► Super-Fast-Recovery Diodes (S-FRDs)

(Ta = 25°C)

Package	Part Number	Absolute Maximum Ratings					Electrical Characteristics (Max)				
		V _{RRM} (V)	I _{F(AV)} (A)	I _{FSM} (A)	T _j (°C)	T _{stg} (°C)	I _{RRM} (μA)	V _{FM} (V)	@ I _{FM} (A)	t _{rr} (ns)	Conditions
 S-FLAT™	CRF02	800	0.5	10	150	-40 to 150	50	3.0	0.5	100	I _F = 1 A, di/dt = -30 A/μs
	CRF03	600	0.7	10	150	-40 to 150	50	2.0	0.7	100	
 M-FLAT™	CMF01	600	2.0	30	150	-40 to 150	50	2.0	2.0	100	I _F = 1 A, di/dt = -30 A/μs
	CMF02	600	1.0	10	150	-40 to 150	50	2.0	1.0	100	
	CMF04	800	0.5	10	150	-40 to 150	50	2.5	0.5	100	
	CMF03	900	0.5	10	125	-40 to 150	50	2.5	0.5	100	
	CMF05	1000	0.5	10	125	-40 to 150	50	2.7	0.5	100	

► High-Efficiency Diodes (HEDs)

(Ta = 25°C)

Package	Part Number	Absolute Maximum Ratings					Electrical Characteristics (Max)				
		V _{RRM} (V)	I _{F(AV)} (A)	I _{FSM} (A)	T _j (°C)	T _{stg} (°C)	I _{RRM} (μA)	V _{FM} (V)	@ I _{FM} (A)	t _{rr} (ns)	Conditions
 S-FLAT™	CRH02	200	0.5	10	150	-40 to 150	10	0.95	0.5	35	I _F = 1 A, di/dt = -30 A/μs
	CRH01	200	1.0	15	150	-40 to 150	10	0.98	1.0	35	
 M-FLAT™	CMH04	200	1.0	20	150	-40 to 150	10	0.98	1.0	35	I _F = 1 A, di/dt = -30 A/μs
	CMH07	200	2.0	40	150	-40 to 150	10	0.98	2.0	35	
	CMH01	200	3.0	40	150	-40 to 150	10	0.98	3.0	35	

Product Characteristics

SMALL & MEDIUM DIODES

Zener Diodes

CRY/CRZ Series (S-FLAT™)

Power Dissipation: 0.7 W

(Ta = 25°C)

Part Number	Power Dissipation (W)	Zener Characteristics					Temperature Coefficient of Zener Voltage α_T (mV/°C)		Forward Voltage V_F (V)	Measurement Current I_F (A)	Reverse Current I_R (μ A)	Measurement Voltage V_R (V)
		Zener Voltage V_Z (V)			Dynamic Resistance r_d (Ω)	Measurement Current I_Z (mA)	Typ.	Max				
		Min	Typ.	Max								
CRY62	0.7	5.6	6.2	6.8	60	10	2	3	1.0	0.2	10	3.0
CRY68	0.7	6.2	6.8	7.4	60	10	3	4	1.0	0.2	10	3.0
CRY82	0.7	7.4	8.2	9.0	30	10	4	6	1.0	0.2	10	4.9
CRZ10	0.7	9.0	10.0	11.0	30	10	6	9	1.0	0.2	10	6.0
CRZ12	0.7	10.8	12.0	13.2	30	10	8	13	1.0	0.2	10	8.0
CRZ13	0.7	11.7	13.0	14.3	30	10	9	14	1.0	0.2	10	9.0
CRZ15	0.7	13.5	15.0	16.5	30	10	11	17	1.0	0.2	10	10.0
CRZ16	0.7	14.4	16.0	17.6	30	10	12	19	1.0	0.2	10	11.0
CRZ18	0.7	16.2	18.0	19.8	30	10	14	23	1.0	0.2	10	13.0
CRZ20	0.7	18.0	20.0	22.0	30	10	16	26	1.0	0.2	10	14.0
CRZ24	0.7	21.6	24.0	26.4	30	10	20	32	1.0	0.2	10	17.0
CRZ27	0.7	24.3	27.0	29.7	30	10	23	36	1.0	0.2	10	19.0
CRZ30	0.7	27.0	30.0	33.0	30	10	25	40	1.0	0.2	10	21.0
CRZ33	0.7	29.7	33.0	36.3	30	10	26	41	1.0	0.2	10	26.4
CRZ36	0.7	32.4	36.0	39.6	30	9	28	45	1.0	0.2	10	28.8
CRZ39	0.7	35.1	39.0	42.9	35	8	30	48	1.0	0.2	10	31.2

CMZB Series (M-FLAT™)

Power Dissipation: 1 W

(Ta = 25°C)

Part Number	Power Dissipation (W)	Zener Characteristics					Temperature Coefficient of Zener Voltage α_T (mV/°C)		Forward Voltage V_F (V)	Measurement Current I_F (A)	Reverse Current I_R (μ A)	Measurement Voltage V_R (V)
		Zener Voltage V_Z (V)			Dynamic Resistance r_d (Ω)	Measurement Current I_Z (mA)	Typ.	Max				
		Min	Typ.	Max								
CMZB12	1.0	10.8	12	13.2	30	10	8	13	1.2	0.2	10	8
CMZB13	1.0	11.7	13	14.3	30	10	9	14	1.2	0.2	10	9
CMZB15	1.0	13.5	15	16.5	30	10	11	17	1.2	0.2	10	10
CMZB18	1.0	16.2	18	19.8	30	10	14	23	1.2	0.2	10	13
CMZB20	1.0	18.0	20	22.0	30	10	16	26	1.2	0.2	10	14
CMZB24	1.0	21.6	24	26.4	30	10	20	32	1.2	0.2	10	17
CMZB27	1.0	24.3	27	29.7	30	10	23	36	1.2	0.2	10	19
CMZB30	1.0	27.0	30	33.0	30	10	25	40	1.2	0.2	10	21
CMZB33	1.0	29.7	33	36.3	30	10	26	41	1.2	0.2	10	26.4
CMZB36	1.0	32.4	36	39.6	30	9	28	45	1.2	0.2	10	28.8
CMZB39	1.0	35.1	39	42.9	35	8	30	48	1.2	0.2	10	31.2
CMZB43	1.0	38.7	43	47.3	40	7	33	53	1.2	0.2	10	34.4
CMZB47	1.0	42.3	47	51.7	65	6	38	60	1.2	0.2	10	37.6
CMZB51	1.0	45.9	51	56.1	65	6	43	68	1.2	0.2	10	40.8
CMZB68	1.0	61.2	68	74.8	120	4	57	90	1.2	0.2	10	54.4
CMZB75	1.0	67.5	75	82.5	150	4	66	104	1.2	0.2	10	60
CMZB82	1.0	73.8	82	90.2	170	3	71	113	1.2	0.2	10	65.6

► **CMZ Series (M-FLAT™)**

Power Dissipation: 2 W

(Ta = 25°C)

Part Number	Power Dissipation (W)	Zener Characteristics					Temperature Coefficient of Zener Voltage α_T (mV/°C)		Forward Voltage V_F (V)	Measurement Current I_F (A)	Reverse Current I_R (μ A)	Measurement Voltage V_R (V)
		Zener Voltage V_Z (V)			Dynamic Resistance r_d (Ω)	Measurement Current I_Z (mA)	Typ.	Max				
		Min	Typ.	Max								
CMZ12	2.0	10.8	12	13.2	30	10	8	13	1.2	0.2	10	8
CMZ13	2.0	11.7	13	14.3	30	10	9	14	1.2	0.2	10	9
CMZ15	2.0	13.5	15	16.5	30	10	11	17	1.2	0.2	10	10
CMZ18	2.0	16.2	18	19.8	30	10	14	23	1.2	0.2	10	13
CMZ20	2.0	18.0	20	22.0	30	10	16	26	1.2	0.2	10	14
CMZ24	2.0	21.6	24	26.4	30	10	20	32	1.2	0.2	10	17
CMZ27	2.0	24.3	27	29.7	30	10	23	36	1.2	0.2	10	19
CMZ30	2.0	27.0	30	33.0	30	10	25	40	1.2	0.2	10	21
CMZ33	2.0	29.7	33	36.3	30	10	26	41	1.2	0.2	10	26.4
CMZ36	2.0	32.4	36	39.6	30	9	28	45	1.2	0.2	10	28.8
CMZ39	2.0	35.1	39	42.9	35	8	30	48	1.2	0.2	10	31.2
CMZ43	2.0	38.7	43	47.3	40	7	33	53	1.2	0.2	10	34.4
CMZ47	2.0	42.3	47	51.7	65	6	38	60	1.2	0.2	10	37.6
CMZ51	2.0	45.9	51	56.1	65	6	43	68	1.2	0.2	10	40.8

Marking

Package	Device Marking (Examples)	
US-FLAT™		<p>Part number (abbreviated) Examples</p> <p>Abbreviation Part number 1: CUS01 7: CUS10I30A</p>
S-FLAT™		<p>Part number (abbreviated) Examples</p> <p>Abbreviation Part number S3: CRS03 G9: CRG09 H1: CRH01</p>
M-FLAT™		<p>Part number (abbreviated) Examples</p> <p>Abbreviation Part number G2: CMG02 F3: CMF03 H7: CMH07</p>
HM-FLAT		<p>Part number (abbreviated) Examples</p> <p>Abbreviation Part number GG2: HMG02</p>

Note

Handwriting practice lines consisting of horizontal dashed lines.



Note

A series of horizontal dashed lines for writing notes.

Toshiba America**Electronic Components, Inc.**

- Irvine, Headquarters
Tel: (949)462-7700 Fax: (949)462-2200
- Buffalo Grove (Chicago)
Tel: (847)484-2400 Fax: (847)541-7287
- Duluth/Atlanta
Tel: (770)931-3363 Fax: (770)931-7602
- El Paso
Tel: (915)533-4242
- Marlborough
Tel: (508)481-0034 Fax: (508)481-8828
- Parsippany
Tel: (973)541-4715 Fax: (973)541-4716
- San Jose
Tel: (408)526-2400 Fax: (408)526-2410
- Wixom (Detroit)
Tel: (248)347-2607 Fax: (248)347-2602

Toshiba Electronics do Brasil Ltda.

- Tel: (011)2936-6681 Fax: (011)2936-6675

Toshiba India Private Ltd.

- New Delhi Office
Tel: (0124)499-6600 Fax: (0124)499-6611
- Bangalore Office
Tel: (080)251-90800 Fax: (080)490-91945

Toshiba Electronics Europe GmbH

- Düsseldorf Head Office
Tel: (0211)5296-0 Fax: (0211)5296-400
- France Branch
Tel: (1)47282181
- Italy Branch
Tel: (039)68701 Fax: (039)6870205
- Munich Office
Tel: (089)20302030 Fax: (089)203020310
- Spain Branch
Tel: (91)660-6798 Fax: (91)660-6799
- Sweden Branch
Tel: (08)704-0900 Fax: (08)80-8459
- U.K. Branch
Tel: (1932)841600

Toshiba Vietnam Consumer Products Co.,Ltd.

- Tel: (043)776-5950 Fax: (043)776-5956

Toshiba Electronics Asia (Singapore) Pte. Ltd.

- Tel: (6278)5252 Fax: (6271)5155

Toshiba Electronics Service (Thailand) Co., Ltd.

- Tel: (02)835-3491 Fax: (02)835-3490

Toshiba Electronics Trading (Malaysia)Sdn. Bhd.

- Kuala Lumpur Head Office
Tel: (03)5631-6311 Fax: (03)5631-6307
- Penang Office
Tel: (04)226-8523 Fax: (04)226-8515

Toshiba Electronics (China) Co., Ltd.

- Shanghai Head Office
Tel: (021)6139-3888 Fax: (021)6190-8288
- Beijing Branch
Tel: (010)6590-8796 Fax: (010)6590-8791
- Chengdu Branch
Tel: (028)8675-1773 Fax: (028)8675-1065
- Hangzhou Office
Tel: (0571)8717-5004 Fax: (0571)8717-5013
- Nanjing Office
Tel: (025)8689-0070 Fax: (025)8689-0125
- Qingdao Branch
Tel: (532)8579-3328 Fax: (532)8579-3329
- Shenzhen Branch
Tel: (0755)3686-0880 Fax: (0755)3686-0816
- Dalian Branch
Tel: (0411)8368-6882 Fax: (0411)8369-0822
- Xiamen Branch
Tel: (0592)226-1398 Fax: (0592)226-1399
- Dongguan Branch
Tel: (0769)8155-6858 Fax: (0769)8155-6368
- Toshiba Electronics Asia, Ltd.
Tel: 2375-6111 Fax: 2375-0969
- Toshiba Electronics Korea Corporation
Tel: (02)3484-4334 Fax: (02)3484-4302
- Toshiba Electronics Taiwan Corporation
Tel: (02)2508-9988 Fax: (02)2508-9999

RESTRICTIONS ON PRODUCT USE

- ▶ Toshiba Corporation, and its subsidiaries and affiliates (collectively "TOSHIBA"), reserve the right to make changes to the information in this document, and related hardware, software and systems (collectively "Product") without notice.
- ▶ This document and any information herein may not be reproduced without prior written permission from TOSHIBA. Even with TOSHIBA's written permission, reproduction is permissible only if reproduction is without alteration/omission.
- ▶ Though TOSHIBA works continually to improve Product's quality and reliability, Product can malfunction or fail. Customers are responsible for complying with safety standards and for providing adequate designs and safeguards for their hardware, software and systems which minimize risk and avoid situations in which a malfunction or failure of Product could cause loss of human life, bodily injury or damage to property, including data loss or corruption. Before customers use the Product, create designs including the Product, or incorporate the Product into their own applications, customers must also refer to and comply with (a) the latest versions of all relevant TOSHIBA information, including without limitation, this document, the specifications, the data sheets and application notes for Product and the precautions and conditions set forth in the "TOSHIBA Semiconductor Reliability Handbook" and (b) the instructions for the application with which the Product will be used with or for. Customers are solely responsible for all aspects of their own product design or applications, including but not limited to (a) determining the appropriateness of the use of this Product in such design or applications; (b) evaluating and determining the applicability of any information contained in this document, or in charts, diagrams, programs, algorithms, sample application circuits, or any other referenced documents; and (c) validating all operating parameters for such designs and applications. **TOSHIBA ASSUMES NO LIABILITY FOR CUSTOMERS' PRODUCT DESIGN OR APPLICATIONS.**
- ▶ **PRODUCT IS NEITHER INTENDED NOR WARRANTED FOR USE IN EQUIPMENTS OR SYSTEMS THAT REQUIRE EXTRAORDINARILY HIGH LEVELS OF QUALITY AND/OR RELIABILITY, AND/OR A MALFUNCTION OR FAILURE OF WHICH MAY CAUSE LOSS OF HUMAN LIFE, BODILY INJURY, SERIOUS PROPERTY DAMAGE AND/OR SERIOUS PUBLIC IMPACT ("UNINTENDED USE").** Except for specific applications as expressly stated in this document, Unintended Use includes, without limitation, equipment used in nuclear facilities, equipment used in the aerospace industry, medical equipment, equipment used for automobiles, trains, ships and other transportation, traffic signaling equipment, equipment used to control combustions or explosions, safety devices, elevators and escalators, devices related to electric power, and equipment used in finance-related fields. **IF YOU USE PRODUCT FOR UNINTENDED USE, TOSHIBA ASSUMES NO LIABILITY FOR PRODUCT.** For details, please contact your TOSHIBA sales representative.
- ▶ Do not disassemble, analyze, reverse-engineer, alter, modify, translate or copy Product, whether in whole or in part.
- ▶ Product shall not be used for or incorporated into any products or systems whose manufacture, use, or sale is prohibited under any applicable laws or regulations.
- ▶ The information contained herein is presented only as guidance for Product use. No responsibility is assumed by TOSHIBA for any infringement of patents or any other intellectual property rights of third parties that may result from the use of Product. No license to any intellectual property right is granted by this document, whether express or implied, by estoppel or otherwise.
- ▶ **ABSENT A WRITTEN SIGNED AGREEMENT, EXCEPT AS PROVIDED IN THE RELEVANT TERMS AND CONDITIONS OF SALE FOR PRODUCT, AND TO THE MAXIMUM EXTENT ALLOWABLE BY LAW, TOSHIBA (1) ASSUMES NO LIABILITY WHATSOEVER, INCLUDING WITHOUT LIMITATION, INDIRECT, CONSEQUENTIAL, SPECIAL, OR INCIDENTAL DAMAGES OR LOSS, INCLUDING WITHOUT LIMITATION, LOSS OF PROFITS, LOSS OF OPPORTUNITIES, BUSINESS INTERRUPTION AND LOSS OF DATA, AND (2) DISCLAIMS ANY AND ALL EXPRESS OR IMPLIED WARRANTIES AND CONDITIONS RELATED TO SALE, USE OF PRODUCT, OR INFORMATION, INCLUDING WARRANTIES OR CONDITIONS OF MERCHANTABILITY, FITNESS FOR A PARTICULAR PURPOSE, ACCURACY OF INFORMATION, OR NONINFRINGEMENT.**
- ▶ Do not use or otherwise make available Product or related software or technology for any military purposes, including without limitation, for the design, development, use, stockpiling or manufacturing of nuclear, chemical, or biological weapons or missile technology products (mass destruction weapons). Product and related software and technology may be controlled under the applicable export laws and regulations including, without limitation, the Japanese Foreign Exchange and Foreign Trade Law and the U.S. Export Administration Regulations. Export and re-export of Product or related software or technology are strictly prohibited except in compliance with all applicable export laws and regulations.
- ▶ Please contact your TOSHIBA sales representative for details as to environmental matters such as the RoHS compatibility of Product. Please use Product in compliance with all applicable laws and regulations that regulate the inclusion or use of controlled substances, including without limitation, the EU RoHS Directive. **TOSHIBA ASSUMES NO LIABILITY FOR DAMAGES OR LOSSES OCCURRING AS A RESULT OF NONCOMPLIANCE WITH APPLICABLE LAWS AND REGULATIONS.**

TOSHIBA**TOSHIBA CORPORATION**

Semiconductor & Storage Products Company

Website: <http://toshiba.semicon-storage.com/>

X-ON Electronics

Largest Supplier of Electrical and Electronic Components

Click to view similar products for [Schottky Diodes & Rectifiers](#) category:

Click to view products by [Toshiba](#) manufacturer:

Other Similar products are found below :

[MA4E2039](#) [MMBD301M3T5G](#) [RB160M-50TR](#) [D83C](#) [BAS16E6433HTMA1](#) [BAS 3010S-02LRH E6327](#) [BAT 54-02LRH E6327](#)
[NRVBAF360T3G](#) [NSR05F40QNXT5G](#) [NTE555](#) [JANS1N6640](#) [SS3003CH-TL-E](#) [GA01SHT18](#) [CRS10I30A\(TE85L,QM](#) [MBRA140TRPBF](#)
[MBRB30H30CT-1G](#) [BAT 15-04R E6152](#) [JANTX1N5712-1](#) [DMJ3940-000](#) [SB007-03C-TB-E](#) [NRVBB20100CTT4G](#) [NRVBM120LT1G](#)
[NTSB30U100CT-1G](#) [CRG04\(T5L,TEMQ\)](#) [ACDBA1100LR-HF](#) [ACDBA1200-HF](#) [ACDBA240-HF](#) [ACDBA3100-HF](#) [CDBQC0530L-HF](#)
[ACDBA260LR-HF](#) [ACDBA1100-HF](#) [10BQ015-M3/5BT](#) [NRVBM120ET1G](#) [VSSB410S-M3/5BT](#) [1N5819T-G](#) [PDS1040Q-13](#) [B160BQ-13-F](#)
[SDM05U20CSP-7](#) [BAS 70-07 E6433](#) [B140S1F-7](#) [HSM560Je3/TR13](#) [DDB2265-000](#) [ZHCS506QTA](#) [HSM190Je3/TR13](#) [B330AF-13](#)
[ACDBUC0230-HF](#) [SDM1U100S1F-7](#) [MBR10200CTF-G1](#) [CDLL5712](#) [DMF2822-000](#)