

# LED A Lamp B2C -A60Bulb 60W (Low flicker)

Authorized Licensee for TOSHIBA trademark



## 1. Specification:

### A. General Data

Model	Classic A lamp 60W 3000K	Classic A lamp 60W 4000K	Classic A lamp 60W 6500K
P/N	DELS-BL348P5B0AE21	DELS-BL448P5B0AE21	DELS-BLC48P5B0AE21
Westnet Code	00168800	00168802	00168804
Rated Voltage	230 VAC	230 VAC	230 VAC
Frequency	50 Hz	50 Hz	50 Hz
Rated Wattage	8.5W	8.5W	8.5W
Deviation Tolerance of Wattage	±10 %	±10 %	±10 %
Displacement Factor	>0.5	>0.5	>0.5
Rated Current	74 mA	74 mA	74 mA
Maximum Input Current	85 mA	85 mA	85 mA
Start On	<0.5S	<0.5S	<0.5S
Warm-up time up to 60% of the full light output	<1S	<1S	<1S
Dimmable	NO	NO	NO
Beam Angle	180°	180°	180°
Stroboscopic effect metric (SVM)	≤ 0.9	≤ 0.9	≤ 0.9
Flicker metric (PstLM)	≤ 1	≤ 1	≤ 1
Energy Efficiency Class	F	F	F
Safety requirements	CE		
Applicable Environments	Dry locations; Not suitable for totally enclosed fixtures		
Ingress protection rating	IP20		
Impact resistance	N.A		
Incandescent Equivalent	60W	60W	60W
Base	E27	E27	E27
Photobiological Group	RG 0	RG 0	RG 0

\* Displacement factor tolerance +/- 10%

### B. Light Data

Color	Warm white	Neutral White	Cool White
Color Temperature (CCT)	3000K	4000K	6500K
Rated Lumen Output*	<b>806lm</b>		
Color Rendering Index	$\geq 80$		
Efficacy( Useful)*	94.8 lm/W		
Efficacy( Total )*	94.8 lm/W		
Color Consistency**	6 Step MacAdam Ellipse (6 SDCM)		

\*tolerance +/- 10%

\*\* 3000K center point (0.4338, 0.403) · 4000K center point (0.3818, 0.3796) · 6500K center point (0.3123, 0.3283)

### C. Lifetime

(Supplied Voltage:AC230V; Ambient Temperature: 25°C)

Lumen Maintenance Factor	70%of the rated lifetime
Rated Lifetime – L <sub>70</sub> B <sub>50</sub>	15,000 hrs
Switching Cycles	$\geq 12,000$

### D. Temperature Operation

Normal operation temperature	-20°C ~ 40°C
Relative Humidity	10%~ 90%

### E. Geometric Data

Model	Classic A lamp 60W
Maximum overall length	110 ± 2 mm (4.33 ± 0.08 inch )
Maximum diameter	60 ± 2 mm ( 2.362± 0.08 inch )
Mass	33 ± 5 g

### F. Environmental relevant materials

Mercury (Hg)	Comply with RoHS Directive 2011/65/EU
Lead (Pb)	
Cadmium(Cd)	
Hexavalent Chromium(Cr6+)	
Polybrominated Biphenyls(PBBs)	
Polybrominated Diphenyl Ethers(PBDEs)	
Bis (2-ethylhexyl) phthalate(DEHP)	
Butyl benzyl phthalate(BBP)	
Dibutyl phthalate(DBP)	
Diisobutylphthalate(DIBP)	

## 2. Outline Drawing

Unit : mm

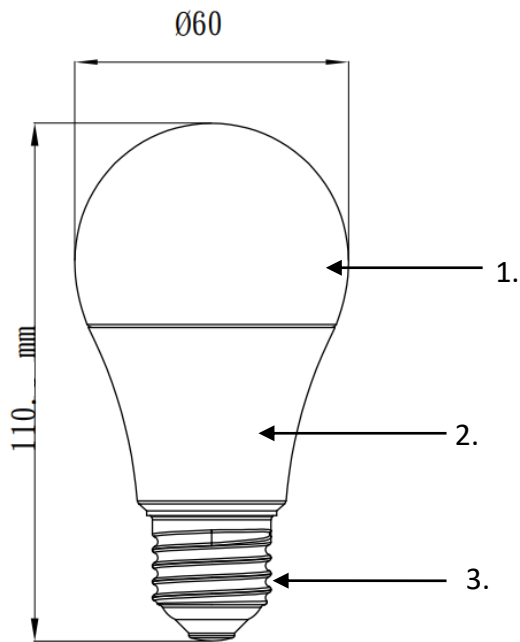

### Material Information

1. Globe: Plastic
2. Body: Plastic
3. Base: Metal

## 3. Light Distribution Curve

FWHM180°

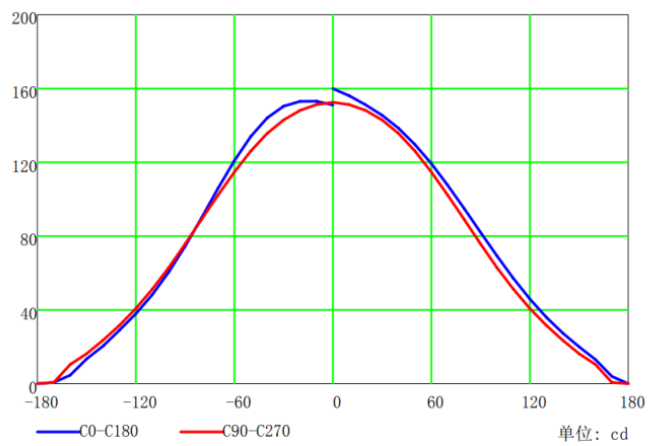
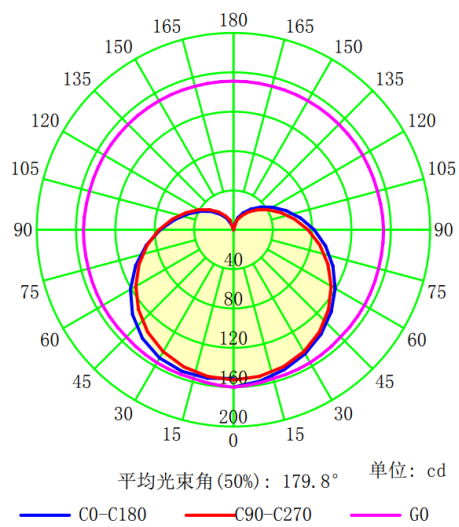

## 4. Spectrum Distribution

3000K: DELS-BL348P5B0AE21

4000K: DELS-BL448P5B0AE21

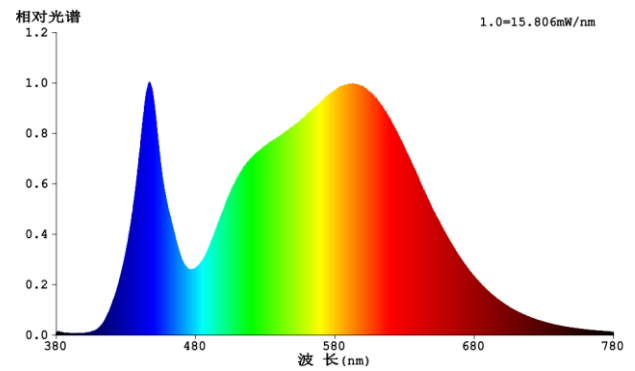
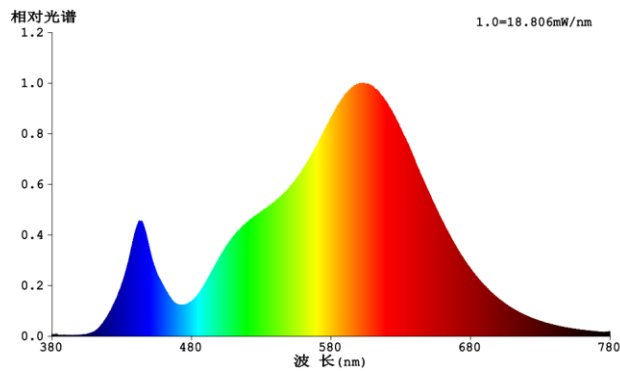

6500K: DELS-BLC48P5B0AE21

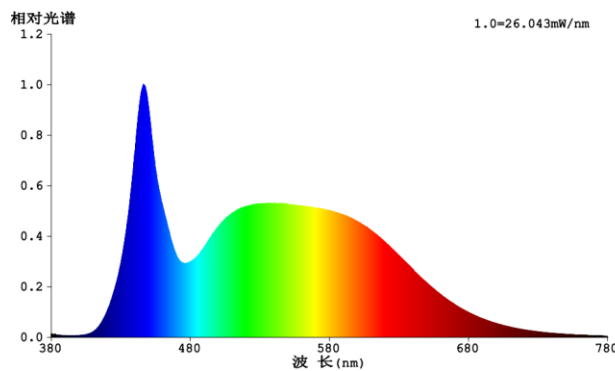

## 5. Warnings

Before replacing, turn off power and let lamp cool to avoid electrical shock or burn.

## 6. Cautions

Only to apply in dry and most of open fixtures with lamp-holders that offer sufficient space (10 mm free air space). Not intended for use with emergency light fixtures for exit lights.

## 7. Notes

All characteristics are estimated at room temperature (25°C), free air burning, base up burning position and at rated voltage. In view of the complex manufacturing process for light above for the technical LED parameters are merely statistical values that do not necessarily correspond to the actual technic individual products may vary from the typical values.

## 8. Logistic information

Model	Classic A lamp 60W 3000K	Classic A lamp 60W 4000K	Classic A lamp 60W 6500K
Pieces per pack	1	1	1
EAN code on pack	4711112384426	4711112384433	4711112384440
Size of pack	60 * 60 * 120mm	60 * 60 * 120mm	60 * 60 * 120mm
Weight per pack (G.W)	53.5g	53.5g	53.5g
Packs per inner box	N/A	N/A	N/A
EAN code on inner box	N/A	N/A	N/A
ITF code on inner box	N/A	N/A	N/A
Size of inner box	N/A	N/A	N/A
Weight per inner box(G.W)	N/A	N/A	N/A
Packs per outer box	100	100	100
EAN code on outer box	N/A	N/A	N/A
ITF code on outer box	14711112384423	14711112384430	14711112384447
Size of outer box	620*320*260mm	620*320*260mm	620*320*260mm
Weight per outer box(G.W)	6.05kg	6.05kg	6.05kg

4711112384426



4711112384433



4711112384440



Packing Photograph

## 9. ERP Label

DELS-BL348P5B0AE21 / DELS-BL448P5B0AE21 / DELS-BLC48P5B0AE21

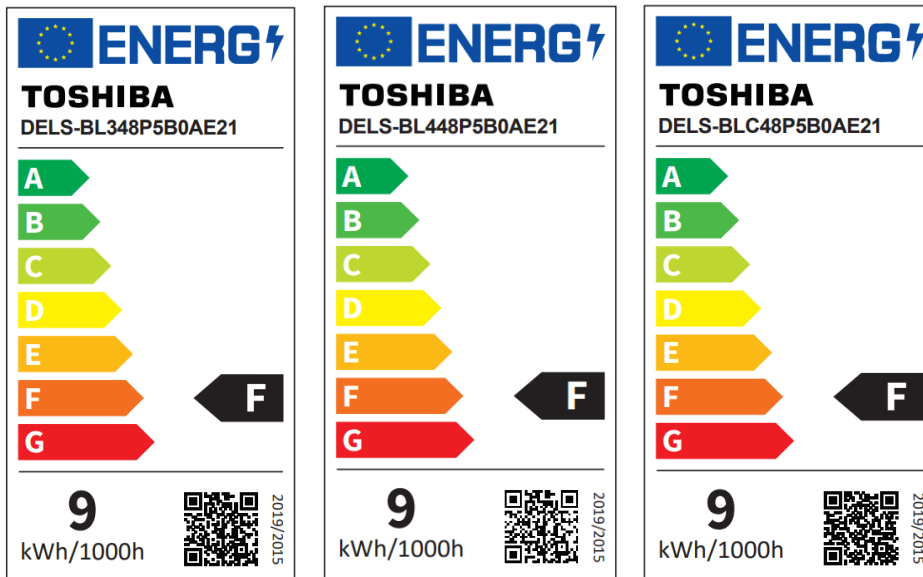

\*Suppliers have to use the EPREL official website to generate a QR-code by a pre-registration.

## 10. Conformity

2014/35/EU; Low Voltage Directive	EN 62560:2012+A1:2015 · EN62471:2008 EN 62493:2015 · IEC/TR 62778: 2014
2014/30/EU; EMC Directive	EN 55015: 2013+A12015 · EN 61000-3-2:2014 · EN 61000-3-3: 2013 EN 61547:2009
2009/125/EC; ErP Directive	(EU) 2019/2015 · (EU) 2019/2020 · (EU) 2021/340 · (EU) 2021/341
2011/65/EU+(EU)2015/863; RoHS Directive	EN 50581: 2012

## X-ON Electronics

Largest Supplier of Electrical and Electronic Components

*Click to view similar products for [LED Replacement Lamps - Based LEDs](#) category:*

*Click to view products by [Toshiba](#) manufacturer:*

Other Similar products are found below :

[LAPD-1A](#) [LAPD-1R](#) [LAPD-6W](#) [SSP-1156B153S12](#) [SSP-1157B156U12](#) [SSP-LXS110818BA](#) [560-0101F](#) [560-0103F](#) [LAPD-1W](#) [LAPD-6R](#)  
[560-0104F](#) [SSP-LXC1283S24](#) [SSP-3MB96U12G](#) [1.90.690.684/0000](#) [560-0203F](#) [586-2206-205F](#) [SSP-LXS1826U16A](#) [24LS4-G1](#) [24LS4-R1](#)  
[MF200-NFW5H](#) [MB403-W60-CW-BP](#) [387LP-A](#) [1819LS2-G-CG](#) [387LP-R](#) [387LP-B](#) [387LP-G](#) [24LS4-W1](#) [6S6LS155-CWR](#) [130MBLS-G-](#)  
[CG](#) [5000404LAMP](#) [6S6LS130-CWW](#) [MF200-BCG12H](#) [MF200-NFR5H](#) [24L4-B1](#) [MF200-NKG120](#) [5SB-NFG24H](#) [MF200C-NFW28H](#)  
[MF200-BCG24H](#) [6S6LS130-CWG](#) [MG200-NFR12H](#) [5SB-NKR120](#) [5000411LAMP](#) [MB403-R6AC-CR](#) [MG200-NWG120](#) [6S6LS120-CWG](#)  
[8718699767655](#) [8718699772154](#) [64650](#) [SKU 217262](#) [SKU 211686](#)