

# LED Filament B2C – CF35\_ Clear glass

Authorized Licensee for TOSHIBA trademark



## 1. Specification:

### A. General Data

<b>Model</b>	CF35 filament 4.5W E14
<b>P/N</b>	DELS-FCW44P5L4AF11
<b>Westnet Code</b>	00172725
<b>Rated Voltage</b>	230 VAC
<b>Frequency</b>	50 Hz
<b>Rated Wattage</b>	4.5 W
<b>Deviation Tolerance of Wattage</b>	±10 %
<b>Rated Current</b>	0.039 A
<b>Maximum Input Current</b>	0.045 A
<b>Start On</b>	<0.5S
<b>Warm up time</b>	<1S
<b>Dimmable</b>	NO
<b>Beam Angle</b>	270°
<b>Energy Efficiency Class(EEC)</b>	F
<b>Peak luminous intensity (cd)</b>	Non-directional
<b>R9 CRI</b>	1
<b>Survival factor</b>	0.9
<b>Lumen Maintenance factor</b>	93.1%
<b>Safety requirements</b>	CE
<b>Displacement factor (cos φ1)**</b>	No limit

<b>Stroboscopic effect metric (SVM)</b>	0.9
<b>Flicker metric (PstLM)</b>	1
<b>Applicable Environments</b>	Dry locations; Not suitable for totally enclosed fixtures
<b>Ingress protection rating</b>	IP20
<b>Impact resistance</b>	N.A
<b>Incandescent Equivalent</b>	40W
<b>Base</b>	E14
<b>Photobiological Group</b>	RG 1

\* Displacement factor tolerance +/- 10%

### B. Light Data

<b>Color</b>	Soft White
<b>Color Temperature (CCT)</b>	2700K
<b>Lumen Output*</b> ( $\phi$ Total °)	<b>470 lm</b>
<b>Color Rendering Index*</b>	$\geq 80$
<b>Efficacy(<math>\phi</math> Total °)</b>	104.44 lm/W
<b>Color Consistency**</b>	6 Step MacAdam Ellipse (6 SDCM)

\* tolerance +/- 10%

\*\* 2700K center point (0.458, 0.410)

### C. Lifetime

(Supplied Voltage: AC 230V ; Ambient Temperature: 25°C)

<b>Lumen Maintenance Factor</b>	70% of the rated lifetime
<b>Rated Lifetime – L<sub>70B50</sub></b>	15,000 hrs
<b>Switch cycles</b>	>20,000

### D. Temperature Operation

<b>Normal operation temperature</b>	-20°C ~ 40°C
<b>Relative Humidity</b>	10% ~ 90%

### E. Geometric Data

<b>Model</b>	CF35 filament 4.5W E14
<b>Maximum overall length</b>	35 ± 2 mm
<b>Maximum overall width</b>	123 ± 2 mm
<b>Mass</b>	31 g ± 10%

### F. Environmental relevant materials

Mercury (Hg)	Comply with RoHS Directive 2011/65/EU
Lead (Pb)	
Cadmium(Cd)	
Hexavalent Chromium(Cr6+)	
Polybrominated Biphenyls(PBBs)	
Polybrominated Diphenyl Ethers(PBDEs)	
Bis (2-ethylhexyl) phthalate(DEHP)	
Butyl benzyl phthalate(BBP)	
Dibutyl phthalate(DBP)	
Diisobutyl phthalate(DIBP)	

### 2. Outline Drawing

Unit : mm

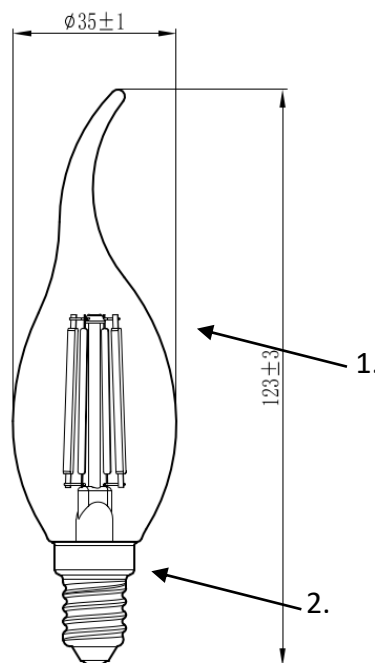

#### Material Information

1. Globe & Body : Glass
2. Base : Metal

### 3. Light Distribution Curve

FWHM 270°

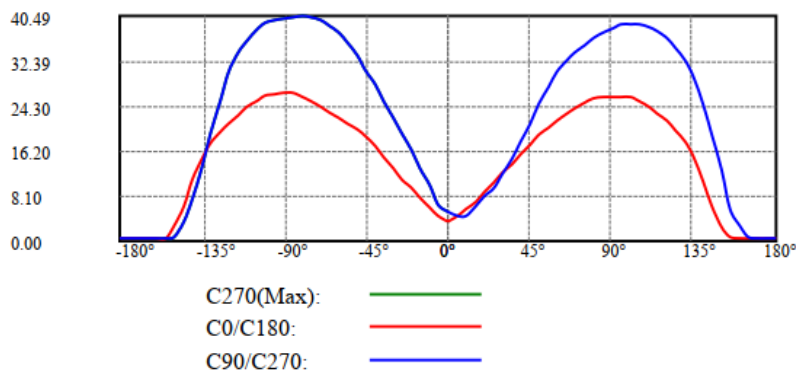
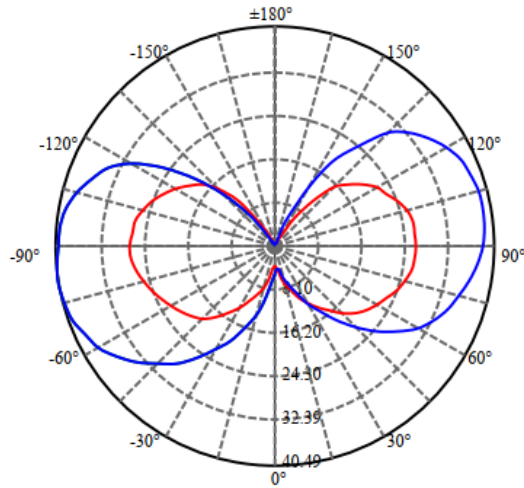

### 4. Spectrum Distribution

- 2700K Color Temperature

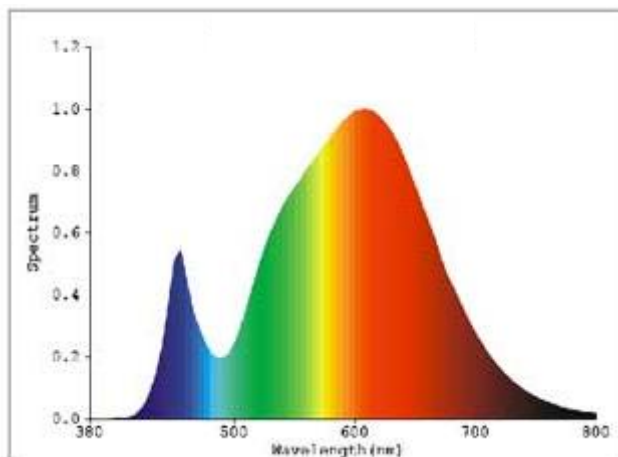

## 5. Warnings

Before replacing, turn off power and let lamp cool to avoid electrical shock or burn.

## 6. Cautions

Only to apply in dry and most of open fixtures with lamp-holders that offer sufficient space (10 mm free air space). Not intended for use with emergency light fixtures for exit lights.

## 7. Notes

All characteristics are estimated at room temperature (25°C), free air burning, base up burning position and at rated voltage. In view of the complex manufacturing process for light above for the technical LED parameters are merely statistical values that do not necessarily correspond to the actual technic individual products may vary from the typical values.

## 8. Logistic information

<b>Model</b>	CF35 filament 4.5W E14 2700K
<b>Pieces per pack</b>	1
<b>EAN code on pack</b>	4711112384327
<b>Size of pack</b>	39 * 39 * 128mm
<b>Weight per pack (G.W)</b>	41g
<b>Packs per inner box</b>	N/A
<b>EAN code on inner box</b>	N/A
<b>ITF code on inner box</b>	N/A
<b>Size of inner box</b>	N/A
<b>Weight per inner box(G.W)</b>	N/A
<b>Packs per outer box</b>	100
<b>EAN code on outer box</b>	N/A
<b>ITF code on outer box</b>	14711112384324
<b>Size of outer box</b>	450 * 220 * 250mm

<b>Weight per outer box(G.W)</b>	3.2kg
<b>Packing Photograph</b>	

### 9. ERP Label



**TOSHIBA**  
DELS-FCW44P5L4AF11

---

**A**

**B**

**C**

**D**

**E**

**F**

**G**



**F**

---

**5**  
kWh/1000h



2019/2015

**10. Conformity**

<b>2014/35/EU; Low Voltage Directive</b>	EN 62560:2012 + A11:2019 · EN 62493:2015 · EN 62471:2008 IEC TR 62778:2014
<b>2014/30/EU; EMC Directive</b>	EN IEC 55015:2019 + A11:2020 · EN IEC 61000-3-2:2019 · EN 61547:2009 EN 61000-3-3:2013 + A1:2019
<b>2009/125/EC; ErP Directive</b>	(EU) 2019/2015 · (EU) 2019/2020 · (EU)2021/340 · (EU)2021/341
<b>2011/65/EU+(EU)2015/863; RoHS Directive</b>	EN 50581: 2012

## X-ON Electronics

Largest Supplier of Electrical and Electronic Components

*Click to view similar products for [LED Replacement Lamps - Based LEDs](#) category:*

*Click to view products by [Toshiba](#) manufacturer:*

Other Similar products are found below :

[LAPD-1A](#) [LAPD-1R](#) [LAPD-6W](#) [SSP-1156B153S12](#) [SSP-1157B156U12](#) [SSP-LXS110818BA](#) [560-0101F](#) [560-0103F](#) [LAPD-1W](#) [LAPD-6R](#)  
[560-0104F](#) [SSP-LXC1283S24](#) [SSP-3MB96U12G](#) [1.90.690.684/0000](#) [560-0203F](#) [586-2206-205F](#) [SSP-LXS1826U16A](#) [24LS4-G1](#) [24LS4-R1](#)  
[MF200-NFW5H](#) [MB403-W60-CW-BP](#) [387LP-A](#) [1819LS2-G-CG](#) [387LP-R](#) [387LP-B](#) [387LP-G](#) [24LS4-W1](#) [6S6LS155-CWR](#) [130MBLS-G-](#)  
[CG](#) [5000404LAMP](#) [6S6LS130-CWW](#) [MF200-BCG12H](#) [MF200-NFR5H](#) [24L4-B1](#) [MF200-NKG120](#) [5SB-NFG24H](#) [MF200C-NFW28H](#)  
[MF200-BCG24H](#) [6S6LS130-CWG](#) [MG200-NFR12H](#) [5SB-NKR120](#) [5000411LAMP](#) [MB403-R6AC-CR](#) [MG200-NWG120](#) [6S6LS120-CWG](#)  
[8718699767655](#) [8718699772154](#) [64650](#) [SKU 217262](#) [SKU 211686](#)