

LED PAR16-76W 38D (Low flicker)

Authorized Licensee for TOSHIBA trademark



1. Specification:

A. General Data

Model	Classic PAR16 38D 76W 3000K	Classic PAR16 38D 76W 4000K	Classic PAR16 38D 76W 6500K
P/N	DELS-GU34007T8AE21	DELS-GU44007T8AE21	DELS-GUC4007T8AE21
Westnet Code	00168867	00168868	00168869
Rated Voltage	230 VAC	230 VAC	230 VAC
Frequency	50 Hz	50 Hz	50 Hz
Rated Wattage	7W	7W	7W
Deviation Tolerance of Wattage	±10 %	±10 %	±10 %
Displacement Factor	0.5	0.5	0.5
Rated Current	60 mA	60 mA	60 mA
Maximum Input Current	70 mA	70 mA	70 mA
Start On	<0.5S	<0.5S	<0.5S
Warm-up time up to 60% of the full light output	<1S	<1S	<1S
Dimmable	NO	NO	NO
Beam Angle	38°	38°	38°
Stroboscopic effect metric (SVM)	≤ 0.9	≤ 0.9	≤ 0.9
Flicker metric (PstLM)	≤ 1	≤ 1	≤ 1
Energy Efficiency Class(EEC)	F	F	F
Safety requirements	CE		
Applicable Environments	Dry locations; Not suitable for totally enclosed fixtures		
Ingress protection rating	IP20		
Impact resistance	N.A		
Incandescent Equivalent	76W	76W	76W
Base	GU10	GU10	GU10
Photobiological Group	RG 0	RG 0	RG 0

* Displacement factor tolerance +/- 10%

B. Light Data

Color	Warm white	Neutral White	Cool White
Color Temperature (CCT)	3000K	4000K	6500K
Rated Lumen Output(Useful)*	560lm		
Rated Lumen Output(Total)*	720lm		
Color Rendering Index	≥ 80		
Efficacy(Useful)*	80 lm/W		
Efficacy(Total)*	102.8 lm/W		
Color Consistency**	6 Step MacAdam Ellipse (6 SDCM)		

*tolerance +/- 10%

** 3000K center point (0.4338, 0.403) · 4000K center point (0.3818, 0.3796) · 6500K center point (0.3123, 0.3283)

C. Lifetime

(Supplied Voltage:AC230V; Ambient Temperature: 25°C)

Lumen Maintenance Factor	70%of the rated lifetime
Rated Lifetime – L ₇₀ B ₅₀	15,000 hrs
Switching Cycles	>12,000

D. Temperature Operation

Normal operation temperature	-20°C ~ 40°C
Relative Humidity	10%~ 90%

E. Geometric Data

Model	Classic PAR16 GU10 63W
Maximum overall length	54 ± 2 mm (2.13 ± 0.08 inch)
Maximum diameter	50 ± 2 mm (1.97± 0.08 inch)
Mass	26.3 ± 3 g

F. Environmental relevant materials

Mercury (Hg)	Comply with RoHS Directive 2011/65/EU
Lead (Pb)	
Cadmium(Cd)	
Hexavalent Chromium(Cr6+)	
Polybrominated Biphenyls(PBBs)	
Polybrominated Diphenyl Ethers(PBDEs)	
Bis (2-ethylhexyl) phthalate(DEHP)	
Butyl benzyl phthalate(BBP)	
Dibutyl phthalate(DBP)	

Diisobutylphthalate(DIBP)

2. Outline Drawing

Unit : mm

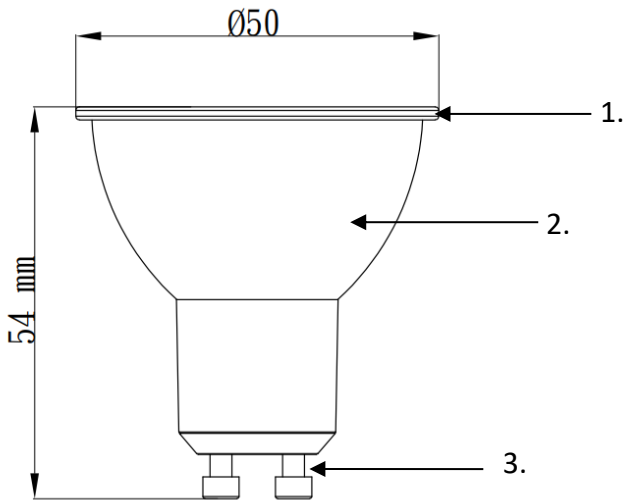

Material Information

- 1. Globe: Plastic
- 2. Body: Plastic
- 3. Base: Metal

3. Light Distribution Curve

FWHM 38°

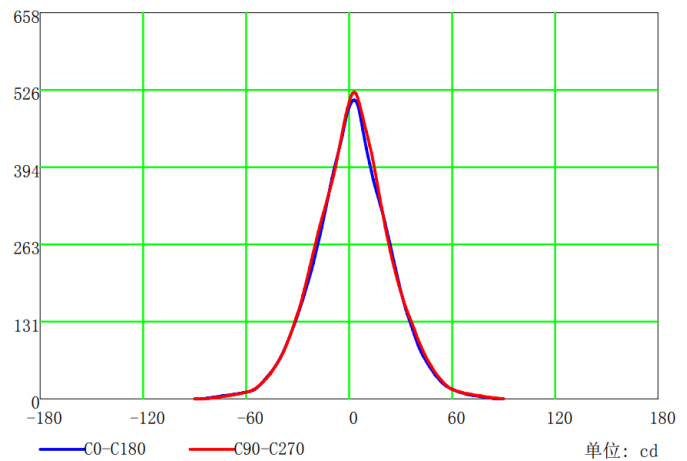
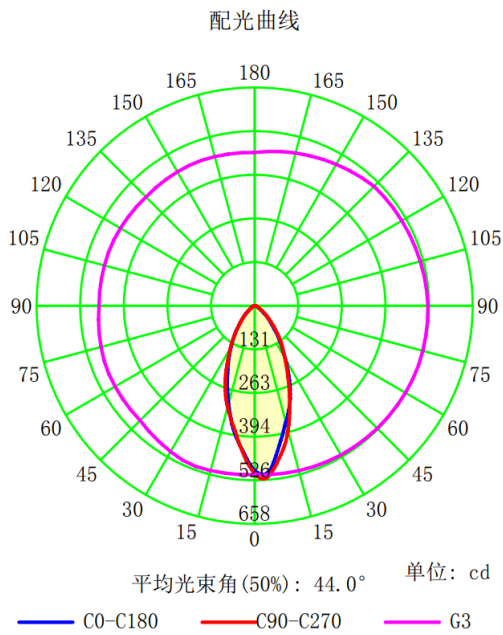

4. Spectrum Distribution

3000K : DELS-GU34007T8AE21

4000K : DELS-GU44007T8AE21

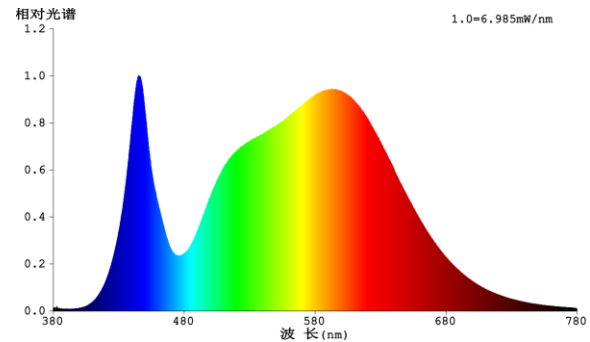
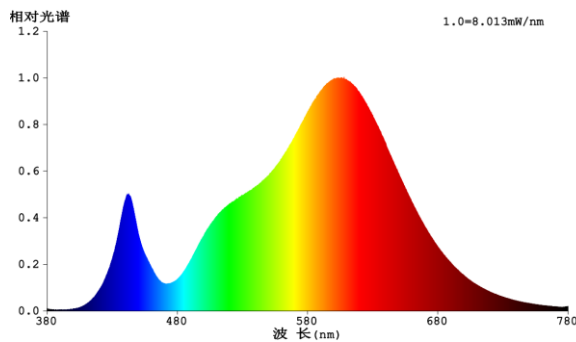

6500K : DELS-GUC4007T8AE21

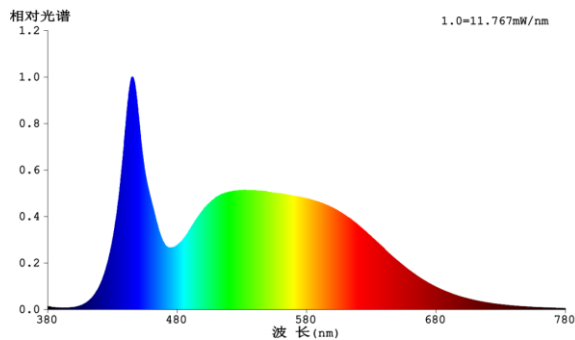

5. Warnings

Before replacing, turn off power and let lamp cool to avoid electrical shock or burn.

6. Cautions

Only to apply in dry and most of open fixtures with lamp-holders that offer sufficient space (10 mm free air space). Not intended for use with emergency light fixtures for exit lights.

7. Notes

All characteristics are estimated at room temperature (25°C), free air burning, base up burning position and at rated voltage. In view of the complex manufacturing process for light above for the technical LED parameters are merely statistical values that do not necessarily correspond to the actual technic individual products may vary from the typical values.

8. Logistic information

Model	Classic PAR16 GU10 76W 3000K	Classic PAR16 GU10 76W 4000K	Classic PAR16 GU10 76W 6500K
Pieces per pack	1	1	1
EAN code on pack	4711112384938	4711112384945	4711112384952
Size of pack	51* 51 * 61mm	51* 51 * 61mm	51* 51 * 61mm
Weight per pack (G.W)	39.2g	39.2g	39.2g
Packs per inner box	N/A	N/A	N/A
EAN code on inner box	N/A	N/A	N/A
ITF code on inner box	N/A	N/A	N/A
Size of inner box	N/A	N/A	N/A
Weight per inner box(G.W)	N/A	N/A	N/A
Packs per outer box	100	100	100
EAN code on outer box	N/A	N/A	N/A
ITF code on outer box	14711112384935	14711112384942	14711112384959
Size of outer box	530*275*145mm	530*275*145mm	530*275*145mm
Weight per outer box(G.W)	4.4kg	4.4kg	4.4kg

Packing Photograph

4711112384938



4711112384945



4711112384952



9. ERP Label

DELS-GU34007T8AE21 / DELS-GU44007T8AE21 / DELS-GUC4007T8AE21

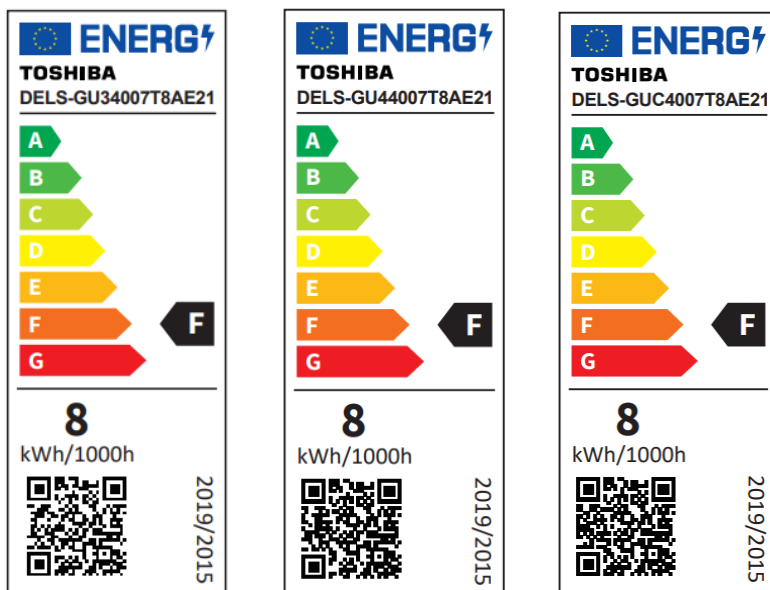

*Suppliers have to use the EPREL official website to generate a QR-code by a pre-registration.

10. Conformity

2014/35/EU; Low Voltage Directive	EN 62560:2012+A1:2015 · EN62471:2008 EN 62493:2015 · IEC/TR 62778: 2014
2014/30/EU; EMC Directive	EN 55015: 2013+A12015 · EN 61000-3-2:2014 · EN 61000-3-3: 2013 EN 61547:2009
2009/125/EC; ErP Directive	(EU) 2019/2015 · (EU) 2019/2020 · (EU) 2021/340 · (EU) 2021/341
2011/65/EU+(EU)2015/863; RoHS Directive	EN 50581: 2012

X-ON Electronics

Largest Supplier of Electrical and Electronic Components

Click to view similar products for [LED Replacement Lamps - Based LEDs](#) category:

Click to view products by [Toshiba](#) manufacturer:

Other Similar products are found below :

[LAPD-1A](#) [LAPD-1R](#) [LAPD-6W](#) [SSP-1156B153S12](#) [SSP-1157B156U12](#) [SSP-LXS110818BA](#) [560-0101F](#) [560-0103F](#) [LAPD-1W](#) [LAPD-6R](#)
[560-0104F](#) [SSP-LXC1283S24](#) [SSP-3MB96U12G](#) [1.90.690.684/0000](#) [560-0203F](#) [586-2206-205F](#) [SSP-LXS1826U16A](#) [24LS4-G1](#) [24LS4-R1](#)
[MF200-NFW5H](#) [MB403-W60-CW-BP](#) [387LP-A](#) [1819LS2-G-CG](#) [387LP-R](#) [387LP-B](#) [387LP-G](#) [24LS4-W1](#) [6S6LS155-CWR](#) [130MBLS-G-](#)
[CG](#) [5000404LAMP](#) [6S6LS130-CWW](#) [MF200-BCG12H](#) [MF200-NFR5H](#) [24L4-B1](#) [MF200-NKG120](#) [5SB-NFG24H](#) [MF200C-NFW28H](#)
[MF200-BCG24H](#) [6S6LS130-CWG](#) [MG200-NFR12H](#) [5SB-NKR120](#) [5000411LAMP](#) [MB403-R6AC-CR](#) [MG200-NWG120](#) [6S6LS120-CWG](#)
[8718699767655](#) [8718699772154](#) [CWA3S-24-CD](#) [64650](#) [SKU 217262](#)