

# LED PAR16-63W 38D (Low flicker)

Authorized Licensee for TOSHIBA trademark



## 1. Specification:

### A. General Data

Model	Classic PAR16 38D 63W 3000K	Classic PAR16 38D 63W 4000K	Classic PAR16 38D 63W 6500K
P/N	DELS-GU345P5T8AE21	DELS-GU445P5T8AE21	DELS-GUC45P5T8AE21
Westnet Code	00168864	00168865	00168866
Rated Voltage	230 VAC	230 VAC	230 VAC
Frequency	50 Hz	50 Hz	50 Hz
Rated Wattage	5.5W	5.5W	5.5W
Deviation Tolerance of Wattage	±10 %	±10 %	±10 %
Displacement Factor	0.5	0.5	0.5
Rated Current	47 mA	47 mA	47 mA
Maximum Input Current	55 mA	55 mA	55 mA
Start On	<0.5S	<0.5S	<0.5S
Warm-up time up to 60% of the full light output	<1S	<1S	<1S
Dimmable	NO	NO	NO
Beam Angle	38°	38°	38°
Stroboscopic effect metric (SVM)	≤ 0.9	≤ 0.9	≤ 0.9
Flicker metric (PstLM)	≤ 1	≤ 1	≤ 1
Energy Efficiency Class(EEC)	F	F	F
Safety requirements	CE		
Applicable Environments	Dry locations; Not suitable for totally enclosed fixtures		
Ingress protection rating	IP20		
Impact resistance	N.A		
Incandescent Equivalent	63W	63W	63W
Base	GU10	GU10	GU10
Photobiological Group	RG 0	RG 0	RG 0

\* Displacement factor tolerance +/- 10%

### B. Light Data

Color	Warm white	Neutral White	Cool White
Color Temperature (CCT)	3000K	4000K	6500K
Rated Lumen Output( Useful )*	450lm		
Rated Lumen Output( Total )*	510lm		
Color Rendering Index	≥ 80		
Efficacy( Useful)*	81.8 lm/W		
Efficacy( Total )*	92.7 lm/W		
Color Consistency**	6 Step MacAdam Ellipse (6 SDCM)		

\*tolerance +/- 10%

\*\* 3000K center point (0.4338, 0.403) · 4000K center point (0.3818, 0.3796) · 6500K center point (0.3123, 0.3283)

### C. Lifetime

(Supplied Voltage:AC230V; Ambient Temperature: 25°C)

Lumen Maintenance Factor	70%of the rated lifetime
Rated Lifetime – L <sub>70</sub> B <sub>50</sub>	15,000 hrs
Switching Cycles	>12,000

### D. Temperature Operation

Normal operation temperature	-20°C ~ 40°C
Relative Humidity	10%~ 90%

### E. Geometric Data

Model	Classic PAR16 GU10 63W
Maximum overall length	54 ± 2 mm (2.13 ± 0.08 inch )
Maximum diameter	50 ± 2 mm ( 1.97± 0.08 inch )
Mass	26.3 ± 3 g

### F. Environmental relevant materials

Mercury (Hg)	Comply with RoHS Directive 2011/65/EU
Lead (Pb)	
Cadmium(Cd)	
Hexavalent Chromium(Cr6+)	
Polybrominated Biphenyls(PBBs)	
Polybrominated Diphenyl Ethers(PBDEs)	
Bis (2-ethylhexyl) phthalate(DEHP)	
Butyl benzyl phthalate(BBP)	
Dibutyl phthalate(DBP)	
Diisobutylphthalate(DIBP)	

## 2. Outline Drawing

Unit : mm

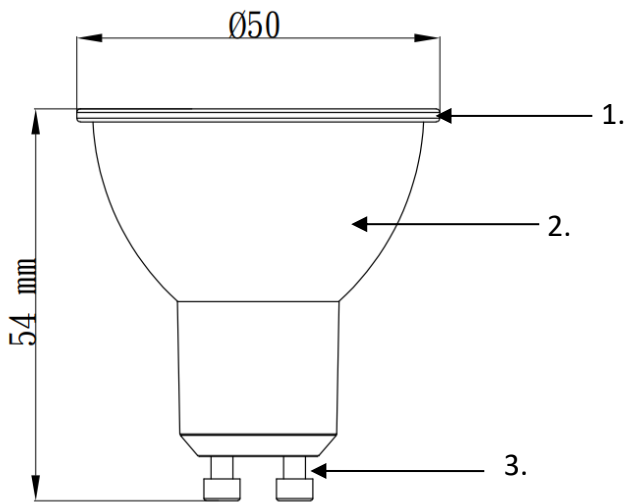

### Material Information

- 1. Globe: Plastic
- 2. Body: Plastic
- 3. Base: Metal

## 3. Light Distribution Curve

FWHM 38°

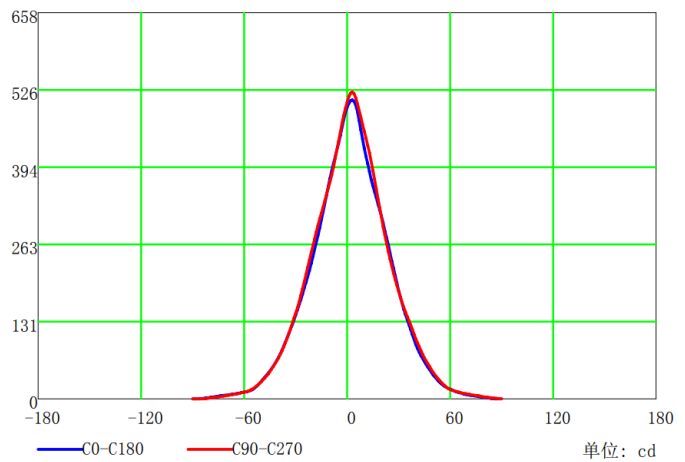
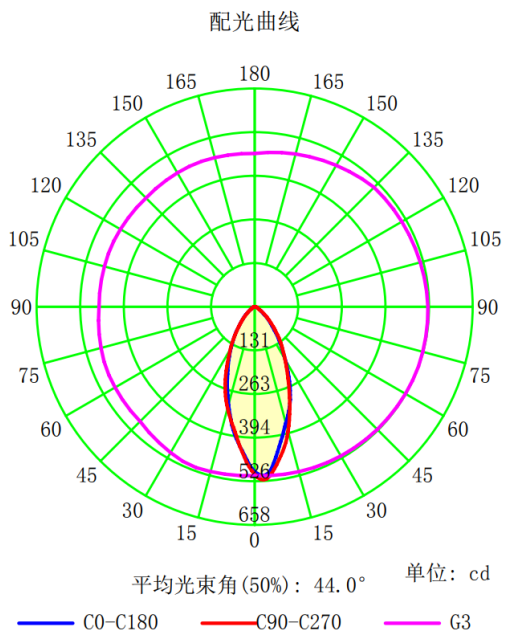

## 4. Spectrum Distribution

3000K : DELS-GU345P5T8AE21

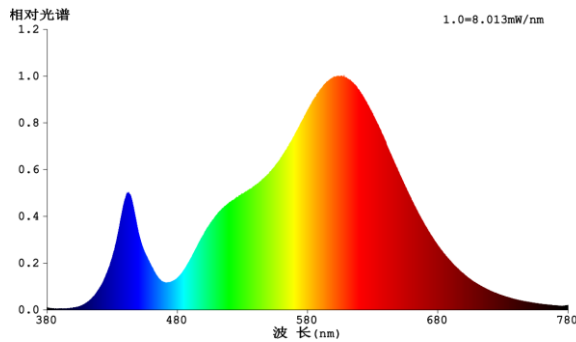

4000K : DELS-GU445P5T8AE21

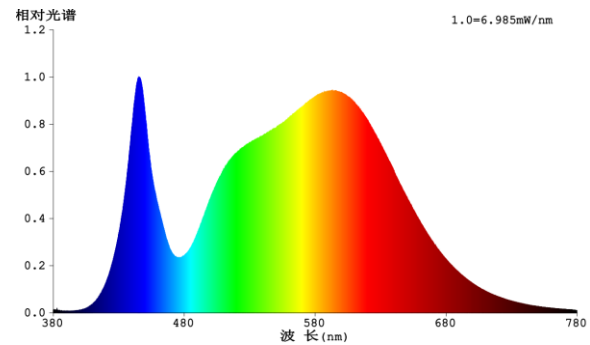

6500K : DELS-GUC45P5T8AE21

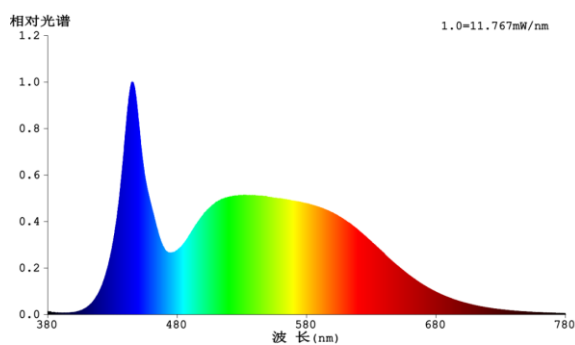

## 5. Warnings

Before replacing, turn off power and let lamp cool to avoid electrical shock or burn.

## 6. Cautions

Only to apply in dry and most of open fixtures with lamp-holders that offer sufficient space (10 mm free air space). Not intended for use with emergency light fixtures for exit lights.

## 7. Notes

All characteristics are estimated at room temperature (25°C), free air burning, base up burning position and at rated voltage. In view of the complex manufacturing process for light above for the technical LED parameters are merely statistical values that do not necessarily correspond to the actual technic individual products may vary from the typical values.

## 8. Logistic information

Model	Classic PAR16 GU10 63W 3000K	Classic PAR16 GU10 63W 4000K	Classic PAR16 GU10 63W 6500K
Pieces per pack	1	1	1
EAN code on pack	4711112384907	4711112384914	4711112384921
Size of pack	51* 51 * 61mm	51* 51 * 61mm	51* 51 * 61mm
Weight per pack (G.W)	39.2g	39.2g	39.2g
Packs per inner box	N/A	N/A	N/A
EAN code on inner box	N/A	N/A	N/A
ITF code on inner box	N/A	N/A	N/A
Size of inner box	N/A	N/A	N/A
Weight per inner box(G.W)	N/A	N/A	N/A
Packs per outer box	100	100	100
EAN code on outer box	N/A	N/A	N/A
ITF code on outer box	14711112384904	14711112384911	14711112384928
Size of outer box	530*275*145mm	530*275*145mm	530*275*145mm
Weight per outer box(G.W)	4.4kg	4.4kg	4.4kg

Packing Photograph

4711112384907



4711112384914



4711112384921



## 9. ERP Label

DELS-GU345P5T8AE21 / DELS-GU445P5T8AE21 / DELS-GUC45P5T8AE21

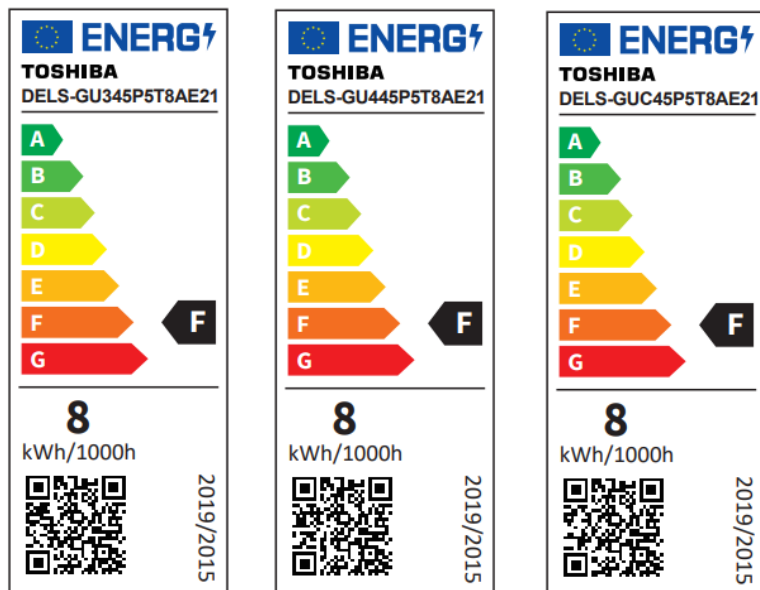

\*Suppliers have to use the EPREL official website to generate a QR-code by a pre-registration.

## 10. Conformity

<b>2014/35/EU; Low Voltage Directive</b>	EN 62560:2012+A1:2015 · EN62471:2008 EN 62493:2015 · IEC/TR 62778: 2014
<b>2014/30/EU; EMC Directive</b>	EN 55015: 2013+A12015 · EN 61000-3-2:2014 · EN 61000-3-3: 2013 EN 61547:2009
<b>2009/125/EC; ErP Directive</b>	(EU) 2019/2015 · (EU) 2019/2020 · (EU) 2021/340 · (EU) 2021/341
<b>2011/65/EU+(EU)2015/863; RoHS Directive</b>	EN 50581: 2012

## X-ON Electronics

Largest Supplier of Electrical and Electronic Components

*Click to view similar products for [LED Replacement Lamps - Based LEDs](#) category:*

*Click to view products by [Toshiba](#) manufacturer:*

Other Similar products are found below :

[LAPD-1A](#) [LAPD-1R](#) [LAPD-6W](#) [SSP-1156B153S12](#) [SSP-1157B156U12](#) [SSP-LXS110818BA](#) [560-0101F](#) [560-0103F](#) [LAPD-1W](#) [LAPD-6R](#)  
[560-0104F](#) [SSP-LXC1283S24](#) [SSP-3MB96U12G](#) [1.90.690.684/0000](#) [560-0203F](#) [586-2206-205F](#) [SSP-LXS1826U16A](#) [24LS4-G1](#) [24LS4-R1](#)  
[MF200-NFW5H](#) [MB403-W60-CW-BP](#) [387LP-A](#) [1819LS2-G-CG](#) [387LP-R](#) [387LP-B](#) [387LP-G](#) [24LS4-W1](#) [6S6LS155-CWR](#) [130MBLS-G-](#)  
[CG](#) [5000404LAMP](#) [6S6LS130-CWW](#) [MF200-BCG12H](#) [MF200-NFR5H](#) [24L4-B1](#) [MF200-NKG120](#) [5SB-NFG24H](#) [MF200C-NFW28H](#)  
[MF200-BCG24H](#) [6S6LS130-CWG](#) [MG200-NFR12H](#) [5SB-NKR120](#) [5000411LAMP](#) [MB403-R6AC-CR](#) [MG200-NWG120](#) [6S6LS120-CWG](#)  
[8718699767655](#) [8718699772154](#) [64650](#) [SKU 217262](#) [SKU 211686](#)