

# LED PAR16-50W 38D (Low flicker)

Authorized Licensee for TOSHIBA trademark



## 1. Specification:

### A. General Data

Model	Classic PAR16 38D 50W 3000K	Classic PAR16 38D 50W 4000K	Classic PAR16 38D 50W 6500K
P/N	DELS-GU34004T8AE21	DELS-GU44004T8AE21	DELS-GUC4004T8AE21
Westnet Code	00168861	00168862	00168863
Rated Voltage	230 VAC	230 VAC	230 VAC
Frequency	50 Hz	50 Hz	50 Hz
Rated Wattage	4W	4W	4W
Deviation Tolerance of Wattage	±10 %	±10 %	±10 %
Displacement Factor	0.5(typical)	0.5(typical)	0.5(typical)
Rated Current	36 mA	36 mA	36 mA
Maximum Input Current	40 mA	40 mA	40 mA
Start On	<0.5S	<0.5S	<0.5S
Warm-up time up to 60% of the full light output	<1S	<1S	<1S
Dimmable	NO	NO	NO
Beam Angle	38°	38°	38°
Stroboscopic effect metric (SVM)	≤ 0.9	≤ 0.9	≤ 0.9
Flicker metric (PstLM)	≤ 1	≤ 1	≤ 1
Energy Efficiency Class(EEC)	F	F	F
Safety requirements	CE		
Applicable Environments	Dry locations; Not suitable for totally enclosed fixtures		
Ingress protection rating	IP20		
Impact resistance	N.A		
Incandescent Equivalent	50W	50W	50W
Base	GU10	GU10	GU10

<b>Photobiological Group</b>	RG 0	RG 0	RG 0
------------------------------	------	------	------

\* Displacement factor tolerance +/- 10%

### B. Light Data

<b>Color</b>	Warm white	Neutral White	Cool White
<b>Color Temperature (CCT)</b>	3000K	4000K	6500K
<b>Rated Lumen Output( Useful )*</b>	<b>345lm</b>		
<b>Rated Lumen Output( Total )*</b>	<b>400lm</b>		
<b>Color Rendering Index</b>	≥ 80		
<b>Efficacy( Useful)*</b>	86.3 lm/W		
<b>Efficacy( Total )*</b>	100 lm/W		
<b>Color Consistency**</b>	6 Step MacAdam Ellipse (6 SDCM)		

\*tolerance +/- 10%

\*\* 3000K center point (0.4338, 0.403) · 4000K center point (0.3818, 0.3796) · 6500K center point (0.3123, 0.3283)

### C. Lifetime

(Supplied Voltage:AC230V; Ambient Temperature: 25°C)

<b>Lumen Maintenance Factor</b>	70%of the rated lifetime
<b>Rated Lifetime – L<sub>70</sub>B<sub>50</sub></b>	15,000 hrs
<b>Switching Cycles</b>	≥12,000

### D. Temperature Operation

<b>Normal operation temperature</b>	-20°C ~ 40°C
<b>Relative Humidity</b>	10%~ 90%

### E. Geometric Data

<b>Model</b>	Classic PAR16 GU10 50W
<b>Maximum overall length</b>	54 ± 2 mm (2.13 ± 0.08 inch )
<b>Maximum diameter</b>	50 ± 2 mm ( 1.97± 0.08 inch )
<b>Mass</b>	26.3 ± 3 g

### F. Environmental relevant materials

<b>Mercury (Hg)</b>	Comply with RoHS Directive 2011/65/EU
<b>Lead (Pb)</b>	
<b>Cadmium(Cd)</b>	
<b>Hexavalent Chromium(Cr6+)</b>	
<b>Polybrominated Biphenyls(PBBs)</b>	
<b>Polybrominated Diphenyl Ethers(PBDEs)</b>	
<b>Bis (2-ethylhexyl) phthalate(DEHP)</b>	
<b>Butyl benzyl phthalate(BBP)</b>	
<b>Dibutyl phthalate(DBP)</b>	
<b>Diisobutylphthalate(DIBP)</b>	

## 2. Outline Drawing

Unit : mm

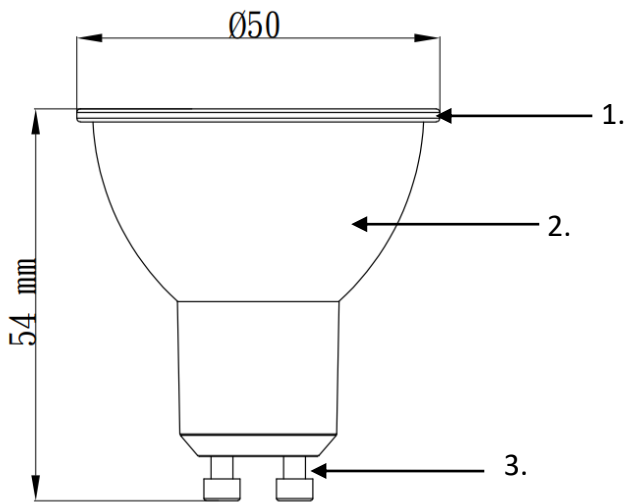

### Material Information

- 1. Globe: Plastic
- 2. Body: Plastic
- 3. Base: Metal

## 3. Light Distribution Curve

FWHM  $38^\circ$

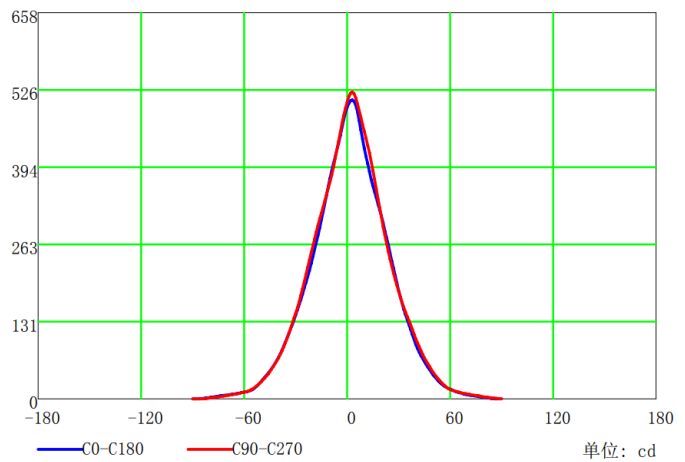
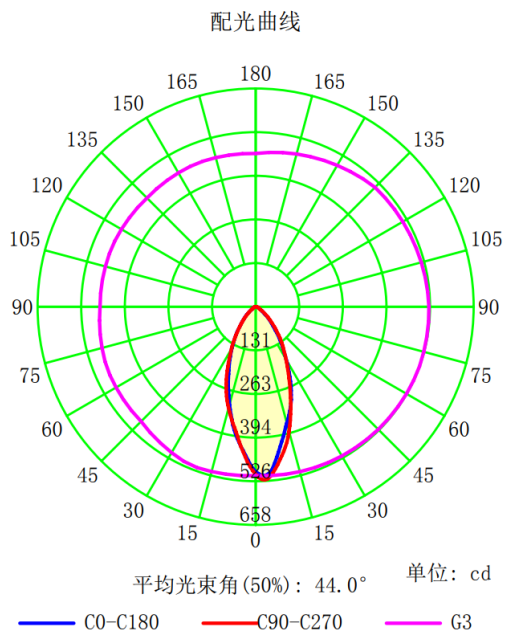

## 4. Spectrum Distribution

3000K : DELS-GU34004T8AE21

4000K : DELS-GU44004T8AE21

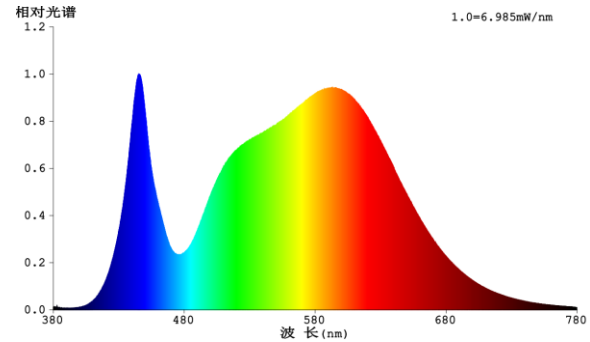
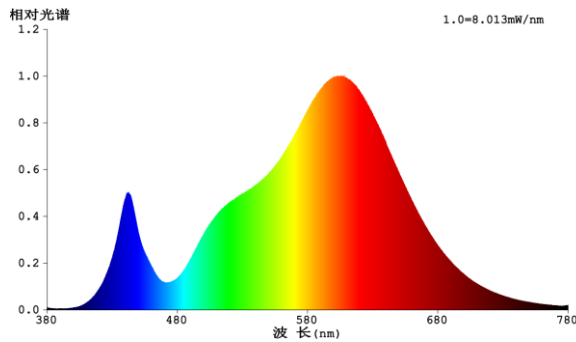

6500K : DELS-GUC4004T8AE21

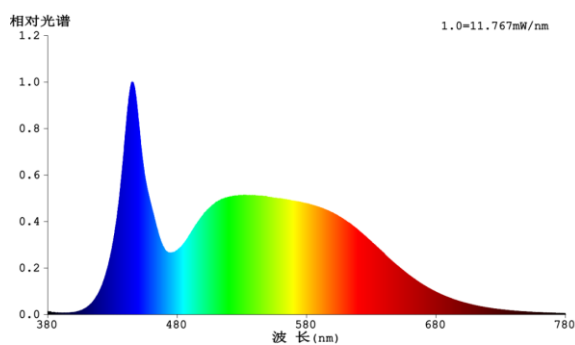

## 5. Warnings

Before replacing, turn off power and let lamp cool to avoid electrical shock or burn.

## 6. Cautions

Only to apply in dry and most of open fixtures with lamp-holders that offer sufficient space (10 mm free air space). Not intended for use with emergency light fixtures for exit lights.

## 7. Notes

All characteristics are estimated at room temperature (25°C), free air burning, base up burning position and at rated voltage. In view of the complex manufacturing process for light above for the technical LED parameters are merely statistical values that do not necessarily correspond to the actual technic individual products may vary from the typical values.

## 8. Logistic information

Model	Classic PAR16 GU10 50W 3000K	Classic PAR16 GU10 50W 4000K	Classic PAR16 GU10 50W 6500K
Pieces per pack	1	1	1
EAN code on pack	4711112384877	4711112384884	4711112384891
Size of pack	51* 51 * 61mm	51* 51 * 61mm	51* 51 * 61mm
Weight per pack (G.W)	39.2g	39.2g	39.2g
Packs per inner box	N/A	N/A	N/A
EAN code on inner box	N/A	N/A	N/A
ITF code on inner box	N/A	N/A	N/A
Size of inner box	N/A	N/A	N/A
Weight per inner box(G.W)	N/A	N/A	N/A
Packs per outer box	100	100	100
EAN code on outer box	N/A	N/A	N/A
ITF code on outer box	14711112384874	14711112384881	14711112384898
Size of outer box	530*275*145mm	530*275*145mm	530*275*145mm
Weight per outer box(G.W)	4.4kg	4.4kg	4.4kg

Packing Photograph

4711112384877



4711112384884



4711112384891



## 9. ERP Label

DELS-GU34004T8AE21 / DELS-GU44004T8AE21 / DELS-GUC4004T8AE21

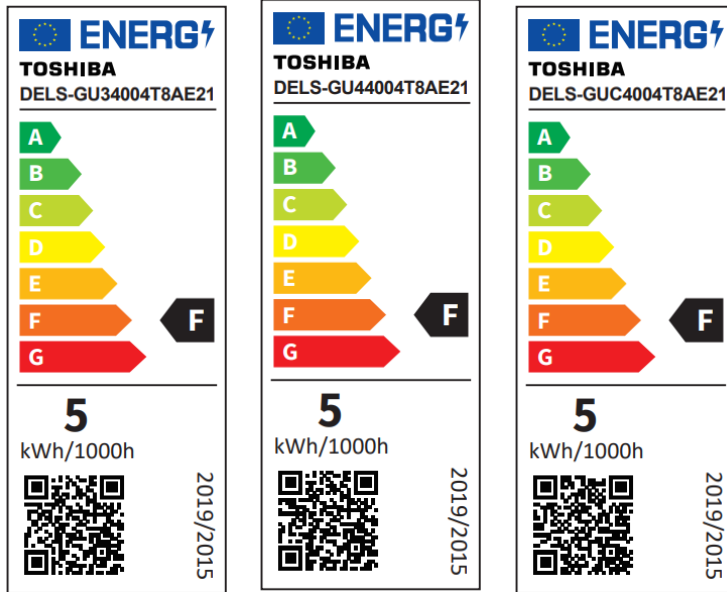

\*Suppliers have to use the EPREL official website to generate a QR-code by a pre-registration.

## 10. Conformity

2014/35/EU; Low Voltage Directive	EN 62560:2012+A1:2015 · EN62471:2008 EN 62493:2015 · IEC/TR 62778: 2014
2014/30/EU; EMC Directive	EN 55015: 2013+A12015 · EN 61000-3-2:2014 · EN 61000-3-3: 2013 EN 61547:2009
2009/125/EC; ErP Directive	(EU) 2019/2015 · (EU) 2019/2020 · (EU) 2021/340 · (EU) 2021/341
2011/65/EU+(EU)2015/863; RoHS Directive	EN 50581: 2012

## X-ON Electronics

Largest Supplier of Electrical and Electronic Components

*Click to view similar products for [LED Replacement Lamps - Based LEDs](#) category:*

*Click to view products by [Toshiba](#) manufacturer:*

Other Similar products are found below :

[LAPD-1A](#) [LAPD-1R](#) [LAPD-6W](#) [SSP-1156B153S12](#) [SSP-1157B156U12](#) [SSP-LXS110818BA](#) [560-0101F](#) [560-0103F](#) [LAPD-1W](#) [LAPD-6R](#)  
[560-0104F](#) [SSP-LXC1283S24](#) [SSP-3MB96U12G](#) [1.90.690.684/0000](#) [560-0203F](#) [586-2206-205F](#) [SSP-LXS1826U16A](#) [24LS4-G1](#) [24LS4-R1](#)  
[MF200-NFW5H](#) [MB403-W60-CW-BP](#) [387LP-A](#) [1819LS2-G-CG](#) [387LP-R](#) [387LP-B](#) [387LP-G](#) [24LS4-W1](#) [6S6LS155-CWR](#) [130MBLS-G-](#)  
[CG](#) [5000404LAMP](#) [6S6LS130-CWW](#) [MF200-BCG12H](#) [MF200-NFR5H](#) [24L4-B1](#) [MF200-NKG120](#) [5SB-NFG24H](#) [MF200C-NFW28H](#)  
[MF200-BCG24H](#) [6S6LS130-CWG](#) [MG200-NFR12H](#) [5SB-NKR120](#) [5000411LAMP](#) [MB403-R6AC-CR](#) [MG200-NWG120](#) [6S6LS120-CWG](#)  
[8718699767655](#) [8718699772154](#) [64650](#) [SKU 217262](#) [SKU 211686](#)