

TOSHIBA Bipolar Linear Integrated Circuit Silicon Monolithic

TA58MS033F, TA58MS05F, TA58MS06F, TA58MS08F, TA58MS09F, TA58MS12F

500-mA Low Dropout Voltage Regulators with ON/OFF Control Switch

The TA58MS**F are small surface-mount low-dropout voltage regulators that provide up to 500mA of output current and an on/off control switch. The EN input can be used to turn on and off the device as necessary and thus helps save system power. The TA58MS**F are suitable for applications requiring low power consumption due to low-dropout voltage and low standby current.

Features

- Active-High on/off switch
- Up to 500-mA output current
- Output voltages: 3.3 / 5 / 6 / 8 / 9 / 12 V
- Output voltage accuracy: $V_{OUT} \pm 3\%$ (@ $T_j = 25^\circ\text{C}$)
- Low quiescent current: 2.5 mA typ. (@ $I_{OUT} = 0\text{ A}$)
- Low standby current (output OFF mode): 1.0 μA (max)
- Low-dropout voltage: 0.7 V (max) (@ $I_{OUT} = 500\text{ mA}$) except the TA58MS033F
- Overcurrent protection / thermal shutdown / 60V load dump protection / overvoltage protection
- Package: 5-pin New PW-Mold (surface-mount)

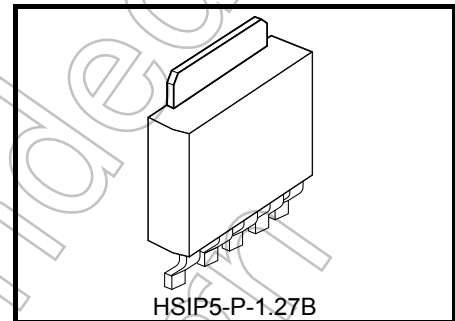

Weight: 0.36 g (Typ.)

Pin Assignment/Marking

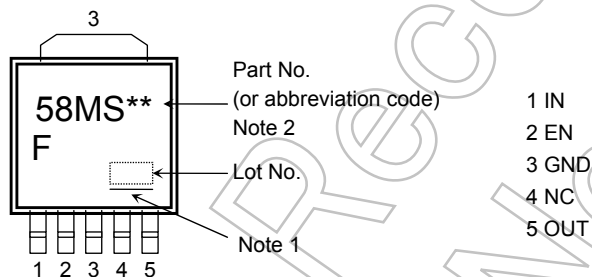

Note 1: A line under a Lot No. identifies the indication of product Labels.

Not underlined: [[Pb]]/INCLUDES > MCV

Underlined: [[G]]/RoHS COMPATIBLE or [[G]]/RoHS [[Pb]]

Please contact your TOSHIBA sales representative for details as to environmental matters such as the RoHS compatibility of Product. The RoHS is the Directive 2011/65/EU of the European Parliament and of the Council of 8 June 2011 on the restriction of the use of certain hazardous substances in electrical and electronic equipment.

Note 2: The “**” in each product name is replaced with the output voltage of each product.

The product(s) in this document (“Product”) contain functions intended to protect the Product from temporary small overloads such as minor short-term overcurrent, overvoltage, or overheating. The protective functions do not necessarily protect Product under all circumstances. When incorporating Product into your system, please design the system (1) to avoid such overloads upon the Product, and (2) to shut down or otherwise relieve the Product of such overload conditions immediately upon occurrence. For details, please refer to the notes appearing below in this document and other documents referenced in this document.

Start of commercial production
2007-10

Pin Description

Pin No.	Symbol	Description
1	IN	Input terminal. Connect a capacitor (C _{IN}) from this pin to ground.
2	EN	Output on/off control. The output turns on when EN is set High and turns off when it is open (undriven) or set Low.
3	GND	Ground
4	NC	No-connect (Note3)
5	OUT	Output terminal. Connected by capacitor (C _{OUT}) to GND.

Note 3: Do not apply current and voltage (including reverse polarity) to the NC pin that is not specified.

How to Order

Part Number	Package	Shipping
TA58MS**F (TE16L1,Q (Note4)	5-pin New PW-Mold (surface-mount)	Tape (2000 pcs/reel)
TA58MS033F (TE16L1Q	5-pin New PW-Mold (surface-mount)	Tape (2000 pcs/reel)

Note 4: The “**” in part numbers represents the output voltage except the TA58M0033F.

Block Diagram

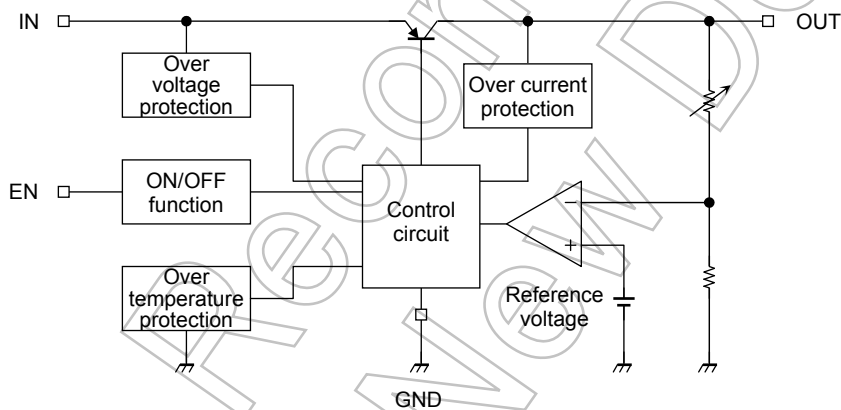

Absolute Maximum Rating (Ta = 25°C)

Characteristic		Symbol	Rating	Unit
Input voltage	DC	V _{IN (DC)}	29	V
	Pulse	V _{IN (Pulse)}	60 ($\tau = 200\text{ms}$, once)	V
EN Input voltage		V _{EN}	V _{IN (DC)}	V
Output current		I _{OUT}	500	mA
Operating junction temperature		T _{jopr}	-40 to 150	°C
Junction temperature		T _j	150	°C
Storage temperature		T _{stg}	-55 to 150	°C
Power dissipation	Ta = 25°C	P _D	1	W
	Tc = 25°C		10	

Note 5: Using continuously under heavy loads (e.g. the application of high temperature/current/voltage and the significant change in temperature, etc.) may cause this product to decrease in the reliability significantly even if the operating conditions (i.e. operating temperature/current/voltage, etc.) are within the absolute maximum ratings and the operating ranges.

Please design the appropriate reliability upon reviewing the Toshiba Semiconductor Reliability Handbook ("Handling Precautions"/"Derating Concept and Methods") and individual reliability data (i.e. reliability test report and estimated failure rate, etc).

Thermal Characteristics

Characteristic	Symbol	Max	Unit
Thermal resistance, junction to ambient	R _{th (j-a)}	125	°C/W
Thermal resistance, junction to case	R _{th (j-c)}	12.5	°C/W

Protection Function (Reference)

Characteristic	Symbol	Test Condition	Min	Typ.	Max	Unit
Thermal shutdown	T _{SD}	V _{IN} = 14 V (033 to 06F) / 16 V (08 to 09F) / 18 V (12F), I _{OUT} = 5 mA	—	175	—	°C
Peak output current	I _{PEAK}	V _{IN} = 14 V (033 to 06F) / 16 V (08 to 09F) / 18 V (12F), T _j = 25°C	—	1	—	A
Short-circuit current	I _{SC}	V _{IN} = 14 V (033 to 06F) / 16 V (08 to 09F) / 18 V (12F), T _j = 25°C	—	0.1	—	A
Overvoltage protection (Note 7)	V _{OV}	T _j = 25°C	29	45	—	V

Note 6: Protection features do not guarantee that the device will be kept below the absolute maximum rated conditions. Ensure that the device will not be exposed to conditions exceeding the absolute maximum ratings.

Note 7: The overvoltage protection circuit shuts down the voltage output.

TA58MS033F

Electrical Characteristics (unless otherwise specified, $V_{EN} = V_{IN}$, $C_{IN} = 1 \mu F$, $C_{OUT} = 10 \mu F$, $T_j = 25^\circ C$)

Characteristic	Symbol	Test Condition	Min	Typ.	Max	Unit
Output voltage	V_{OUT}	$V_{IN} = 14 V, I_{OUT} = 10 mA$	3.201	3.3	3.399	V
		$5 V \leq V_{IN} \leq 26 V, I_{OUT} = 10 mA, -40^\circ C \leq T_j \leq 105^\circ C$	3.168	3.3	3.432	
Line regulation	Reg·line	$4.5 V \leq V_{IN} \leq 26 V, I_{OUT} = 10 mA$	—	3	20	mV
Load regulation	Reg·load	$V_{IN} = 14 V, 5 mA \leq I_{OUT} \leq 500 mA$	—	10	30	mV
Quiescent current	I_B	$4.5 V \leq V_{IN} \leq 26 V, I_{OUT} = 0 A$	—	2.5	5.0	mA
		$4.5 V \leq V_{IN} \leq 26 V, I_{OUT} = 500 mA$	—	30	50	
Quiescent current (Off mode)	$I_{B(OFF)}$	$4.5 V \leq V_{IN} \leq 26 V, V_{EN} = 0.4 V$	—	0.1	1.0	μA
Dropout voltage	V_D	$I_{OUT} = 250 mA$	—	0.9	1.3	V
		$I_{OUT} = 500 mA$	—	0.9	1.3	
Output control voltage (ON)	$V_{EN(ON)}$	—	2	—	—	V
Output control voltage (OFF)	$V_{EN(OFF)}$	—	—	—	0.8	V
Output control current (ON)	$I_{EN(ON)}$	$V_{IN} = 14 V, V_{EN} = 5 V$	—	125	175	μA

TA58MS05F

Electrical Characteristics (unless otherwise specified, $V_{EN} = V_{IN}$, $C_{IN} = 1 \mu F$, $C_{OUT} = 10 \mu F$, $T_j = 25^\circ C$)

Characteristic	Symbol	Test Condition	Min	Typ.	Max	Unit
Output voltage	V_{OUT}	$V_{IN} = 14 V, I_{OUT} = 10 mA$	4.85	5.00	5.15	V
		$6 V \leq V_{IN} \leq 26 V, I_{OUT} = 10 mA, -40^\circ C \leq T_j \leq 105^\circ C$	4.8	5.0	5.2	
Line regulation	Reg·line	$6 V \leq V_{IN} \leq 26 V, I_{OUT} = 10 mA$	—	3	20	mV
Load regulation	Reg·load	$V_{IN} = 14 V, 5 mA \leq I_{OUT} \leq 500 mA$	—	10	30	mV
Quiescent current	I_B	$6 V \leq V_{IN} \leq 26 V, I_{OUT} = 0 A$	—	2.5	5.0	mA
		$6 V \leq V_{IN} \leq 26 V, I_{OUT} = 500 mA$	—	30	50	
Quiescent current (Off mode)	$I_{B(OFF)}$	$6 V \leq V_{IN} \leq 26 V, V_{EN} = 0.4 V$	—	0.1	1.0	μA
Dropout voltage	V_D	$I_{OUT} = 250 mA$	—	0.3	0.4	V
		$I_{OUT} = 500 mA$	—	0.5	0.7	
Output control voltage (ON)	$V_{EN(ON)}$	—	2	—	—	V
Output control voltage (OFF)	$V_{EN(OFF)}$	—	—	—	0.8	V
Output control current (ON)	$I_{EN(ON)}$	$V_{IN} = 14 V, V_{EN} = 5 V$	—	125	175	μA

TA58MS06F

Electrical Characteristics (unless otherwise specified, $V_{EN} = V_{IN}$, $C_{IN} = 1 \mu F$, $C_{OUT} = 10 \mu F$, $T_j = 25^\circ C$)

Characteristic	Symbol	Test Condition	Min	Typ.	Max	Unit
Output voltage	V_{OUT}	$V_{IN} = 14 V, I_{OUT} = 10 mA$	5.82	6.00	6.18	V
		$7 V \leq V_{IN} \leq 26 V, I_{OUT} = 10 mA, -40^\circ C \leq T_j \leq 105^\circ C$	5.76	6.00	6.24	
Line regulation	Reg·line	$7 V \leq V_{IN} \leq 26 V, I_{OUT} = 10 mA$	—	3	20	mV
Load regulation	Reg·load	$V_{IN} = 14 V, 5 mA \leq I_{OUT} \leq 500 mA$	—	10	30	mV
Quiescent current	I_B	$7 V \leq V_{IN} \leq 26 V, I_{OUT} = 0 A$	—	2.5	5.0	mA
		$7 V \leq V_{IN} \leq 26 V, I_{OUT} = 500 mA$	—	30	50	
Quiescent current (Off mode)	$I_{B(OFF)}$	$7 V \leq V_{IN} \leq 26 V, V_{EN} = 0.4 V$	—	0.1	1.0	μA
Dropout voltage	V_D	$I_{OUT} = 250 mA$	—	0.3	0.4	V
		$I_{OUT} = 500 mA$	—	0.5	0.7	
Output control voltage (ON)	$V_{EN(ON)}$	—	2	—	—	V
Output control voltage (OFF)	$V_{EN(OFF)}$	—	—	—	0.8	V
Output control current (ON)	$I_{EN(ON)}$	$V_{IN} = 14 V, V_{EN} = 5 V$	—	125	175	μA

TA58MS08F

Electrical Characteristics (unless otherwise specified, $V_{EN} = V_{IN}$, $C_{IN} = 1 \mu F$, $C_{OUT} = 10 \mu F$, $T_j = 25^\circ C$)

Characteristic	Symbol	Test Condition	Min	Typ.	Max	Unit
Output voltage	V_{OUT}	$V_{IN} = 16 V, I_{OUT} = 10 mA$	7.76	8.00	8.24	V
		$9 V \leq V_{IN} \leq 26 V, I_{OUT} = 10 mA, -40^\circ C \leq T_j \leq 105^\circ C$	7.68	8.00	8.32	
Line regulation	Reg·line	$9 V \leq V_{IN} \leq 26 V, I_{OUT} = 10 mA$	—	3	20	mV
Load regulation	Reg·load	$V_{IN} = 16 V, 5 mA \leq I_{OUT} \leq 500 mA$	—	10	30	mV
Quiescent current	I_B	$9 V \leq V_{IN} \leq 26 V, I_{OUT} = 0 A$	—	2.5	5.0	mA
		$9 V \leq V_{IN} \leq 26 V, I_{OUT} = 500 mA$	—	30	50	
Quiescent current (Off mode)	$I_{B(OFF)}$	$9 V \leq V_{IN} \leq 26 V, V_{EN} = 0.4 V$	—	0.1	1.0	μA
Dropout voltage	V_D	$I_{OUT} = 250 mA$	—	0.3	0.4	V
		$I_{OUT} = 500 mA$	—	0.5	0.7	
Output control voltage (ON)	$V_{EN(ON)}$	—	2	—	—	V
Output control voltage (OFF)	$V_{EN(OFF)}$	—	—	—	0.8	V
Output control current (ON)	$I_{EN(ON)}$	$V_{IN} = 16 V, V_{EN} = 5 V$	—	125	175	μA

TA58MS09F

Electrical Characteristics (unless otherwise specified, $V_{EN} = V_{IN}$, $C_{IN} = 1 \mu F$, $C_{OUT} = 10 \mu F$, $T_j = 25^\circ C$)

Characteristic	Symbol	Test Condition	Min	Typ.	Max	Unit
Output voltage	V_{OUT}	$V_{IN} = 16 V, I_{OUT} = 10 mA$	8.73	9.00	9.27	V
		$10 V \leq V_{IN} \leq 26 V, I_{OUT} = 10 mA,$ $-40^\circ C \leq T_j \leq 105^\circ C$	8.64	9.00	9.36	
Line regulation	Reg·line	$10 V \leq V_{IN} \leq 26 V, I_{OUT} = 10 mA$	—	3	20	mV
Load regulation	Reg·load	$V_{IN} = 16 V, 5 mA \leq I_{OUT} \leq 500 mA$	—	10	30	mV
Quiescent current	I_B	$10 V \leq V_{IN} \leq 26 V, I_{OUT} = 0 A$	—	2.5	5.0	mA
		$10 V \leq V_{IN} \leq 26 V, I_{OUT} = 500 mA$	—	30	50	
Quiescent current (Off mode)	$I_{B(OFF)}$	$10 V \leq V_{IN} \leq 26 V, V_{EN} = 0.4 V$	—	0.1	1.0	μA
Dropout voltage	V_D	$I_{OUT} = 250 mA$	—	0.3	0.4	V
		$I_{OUT} = 500 mA$	—	0.5	0.7	
Output control voltage (ON)	$V_{EN(ON)}$	—	2	—	—	V
Output control voltage (OFF)	$V_{EN(OFF)}$	—	—	—	0.8	V
Output control current (ON)	$I_{EN(ON)}$	$V_{IN} = 16 V, V_{EN} = 5 V$	—	125	175	μA

TA58MS12F

Electrical Characteristics (unless otherwise specified, $V_{EN} = V_{IN}$, $C_{IN} = 1 \mu F$, $C_{OUT} = 10 \mu F$, $T_j = 25^\circ C$)

Characteristic	Symbol	Test Condition	Min	Typ.	Max	Unit
Output voltage	V_{OUT}	$V_{IN} = 18 V, I_{OUT} = 10 mA$	11.64	12.00	12.36	V
		$13 V \leq V_{IN} \leq 26 V, I_{OUT} = 10 mA,$ $-40^\circ C \leq T_j \leq 105^\circ C$	11.52	12.00	12.48	
Line regulation	Reg·line	$13 V \leq V_{IN} \leq 26 V, I_{OUT} = 10 mA$	—	3	20	mV
Load regulation	Reg·load	$V_{IN} = 18 V, 5 mA \leq I_{OUT} \leq 500 mA$	—	10	30	mV
Quiescent current	I_B	$13 V \leq V_{IN} \leq 26 V, I_{OUT} = 0 A$	—	2.5	5.0	mA
		$13 V \leq V_{IN} \leq 26 V, I_{OUT} = 500 mA$	—	30	50	
Quiescent current (Off mode)	$I_{B(OFF)}$	$13 V \leq V_{IN} \leq 26 V, V_{EN} = 0.4 V$	—	0.1	1.0	μA
Dropout voltage	V_D	$I_{OUT} = 250 mA$	—	0.3	0.4	V
		$I_{OUT} = 500 mA$	—	0.5	0.7	
Output control voltage (ON)	$V_{EN(ON)}$	—	2	—	—	V
Output control voltage (OFF)	$V_{EN(OFF)}$	—	—	—	0.8	V
Output control current (ON)	$I_{EN(ON)}$	$V_{IN} = 18 V, V_{EN} = 5 V$	—	125	175	μA

Note on Electrical Characteristics

The test condition $T_j = 25^\circ\text{C}$ means a state where any drifts in electrical characteristics incurred by an increase in the chip's junction temperature can be ignored during pulse testing.

Standard Application Circuit

< Example using an electrolytic capacitor for C_{OUT} >

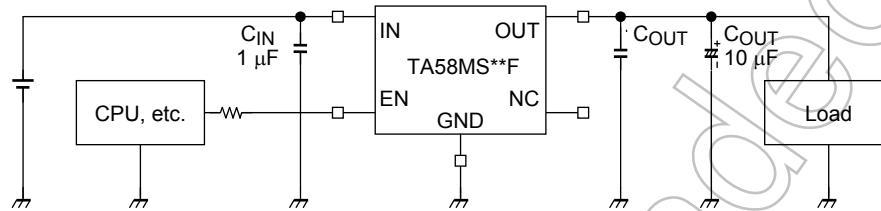

< Example using only a single ceramic capacitor for C_{OUT} >

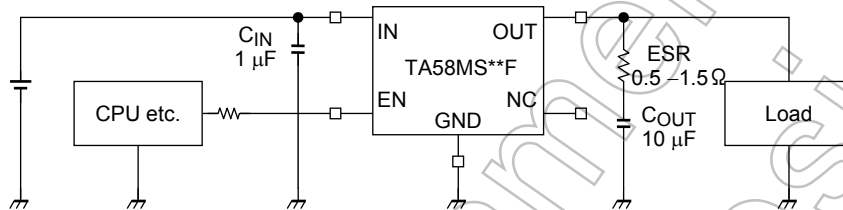

- Connect input and output capacitors (C_{IN} and C_{OUT}) from the IN and OUT pins to ground respectively. Place these capacitors as close as possible to the device pins. C_{OUT} is used to prevent output oscillation and stabilize operation over load variations. However, in a cold environment, the output might oscillate due to a decrease in its capacitance and/or an increase in ESR (equivalent series resistance). It is therefore recommended to use a capacitor whose capacitance and ESR values do not vary greatly with environmental conditions or hours of use. A ceramic capacitor with very small ESR might cause output oscillation if used alone, depending on usage conditions. To reduce the risk of oscillation, electrolytic and ceramic capacitors should be connected in parallel, or a resistor equivalent to the ESR should be connected in series with a ceramic capacitor, as shown above. The output might still oscillate, depending on external conditions such as the capacitor and ESR values, input voltage, output current, temperature and so on. Therefore, appropriate capacitor(s) and resistor should be selected through experimentation using an actual board in which the TA58MS**F will be used.

Precautions for use

- Note that, depending on the load conditions, an abrupt change in the input voltage (V_{IN}) may cause a transient rise in output voltage (V_{OUT}) even if the EN (enable) pin is Low.
- Low voltage
Do not apply voltage to the Product that is lower than the minimum operating voltage, or the Product's protective functions will not operate properly and the Product may be permanently damaged.

- Overcurrent Protection

The overcurrent protection circuits in the Product are designed to temporarily protect Product from minor overcurrent of brief duration. When the overcurrent protective function in the Product activates, immediately cease application of overcurrent to Product. Improper usage of Product, such as application of current to Product exceeding the absolute maximum ratings, could cause the overcurrent protection circuit not to operate properly and/or damage Product permanently even before the protection circuit starts to operate.

- Overheating Protection

The thermal shutdown circuits in the Product are designed to temporarily protect Product from minor overheating of brief duration. When the overheating protective function in the Product activates, immediately correct the overheating situation. Improper usage of Product, such as the application of heat to Product exceeding the absolute maximum ratings, could cause the overheating protection circuit not to operate properly and/or damage Product permanently even before the protection circuit starts to operate.

- Overvoltage Protection

The overvoltage protection circuits in the Product are designed to temporarily protect Product from minor overvoltage of brief duration. When the overvoltage protective function in the Product activates, immediately cease application of overvoltage to Product. Improper usage of Product, such as application of voltage to Product exceeding the absolute maximum ratings, could cause the overvoltage protection circuit not to operate properly and/or damage Product permanently even before the protection circuit starts to operate.

Not Recommended
for New Design

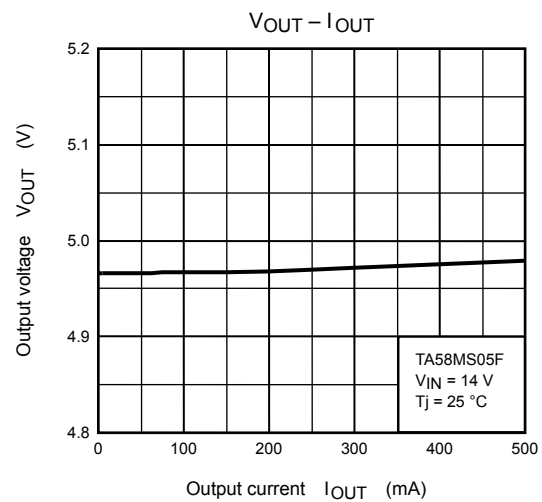
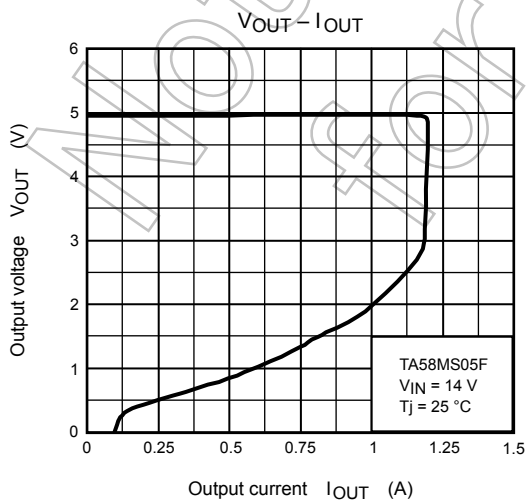
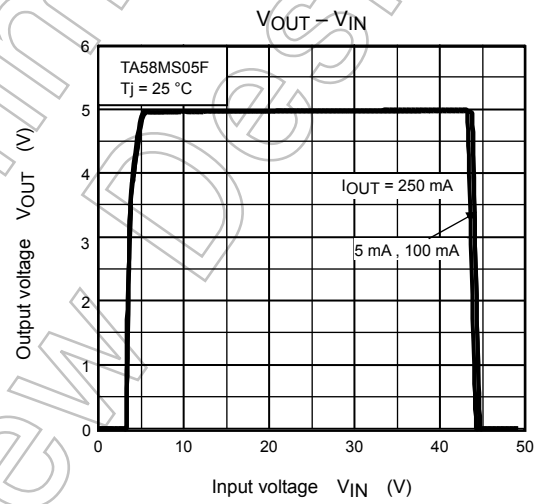
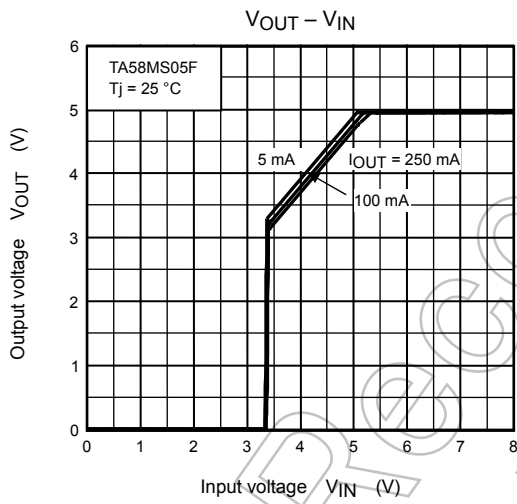
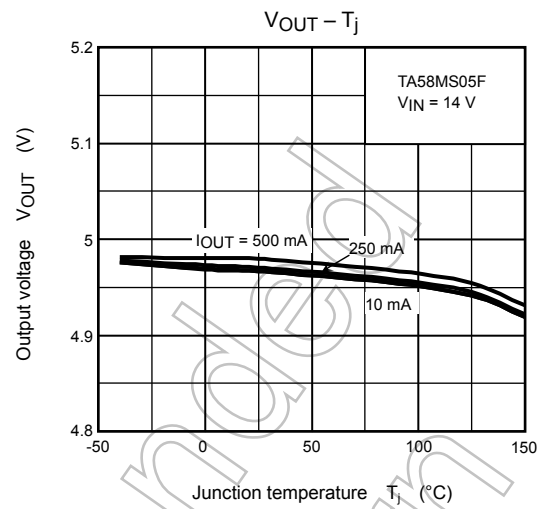
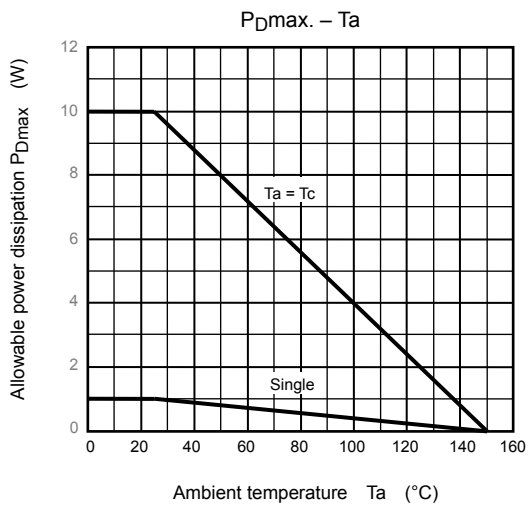

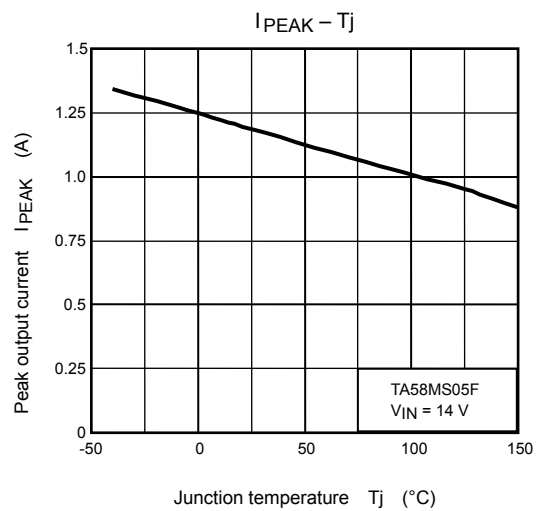
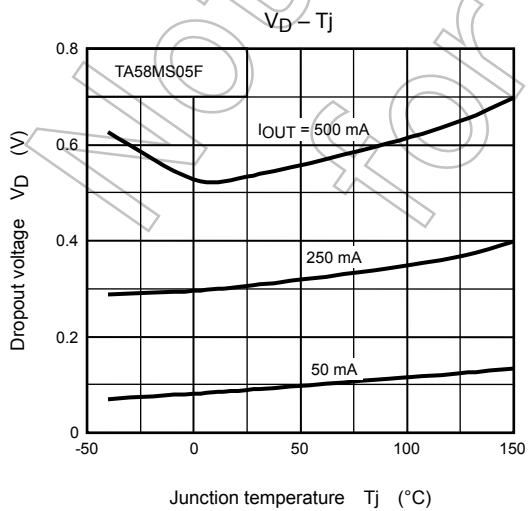
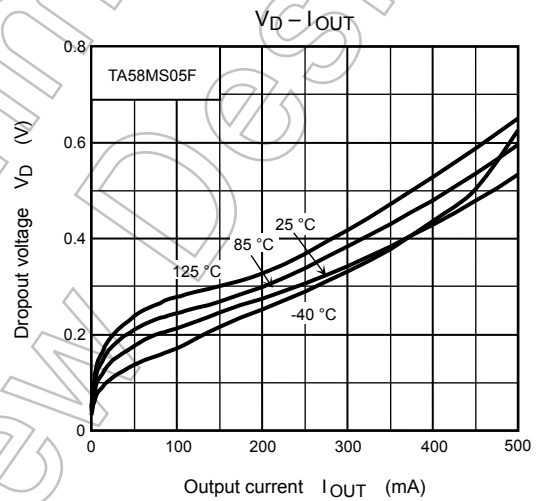
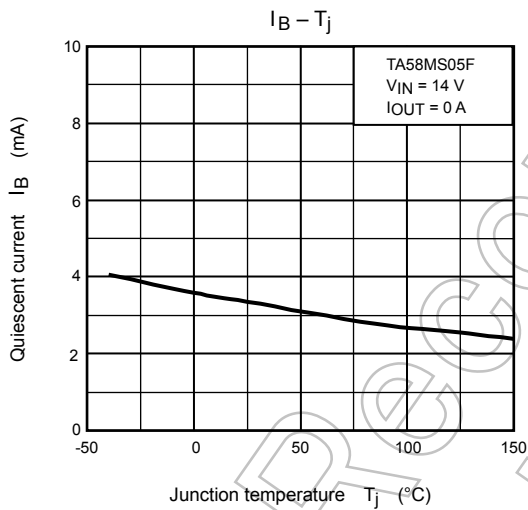
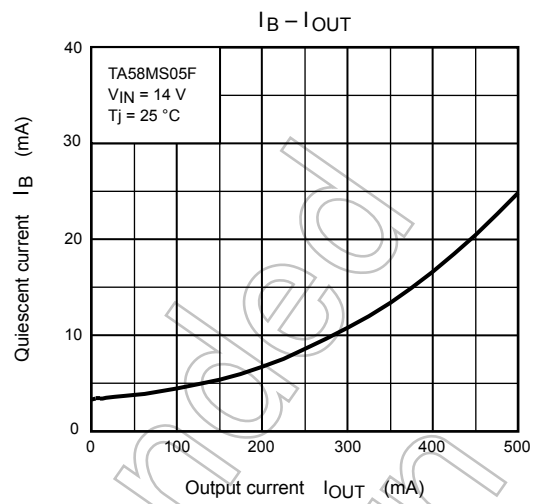
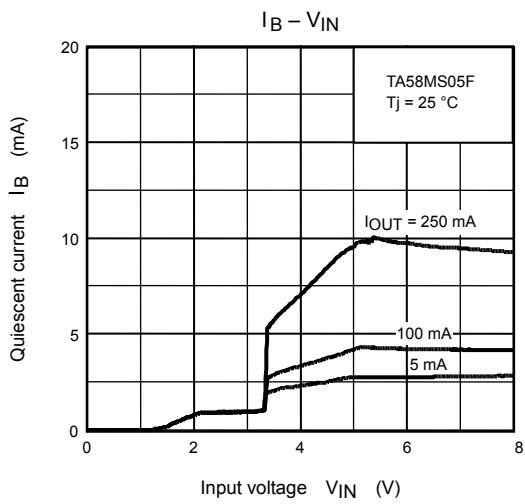

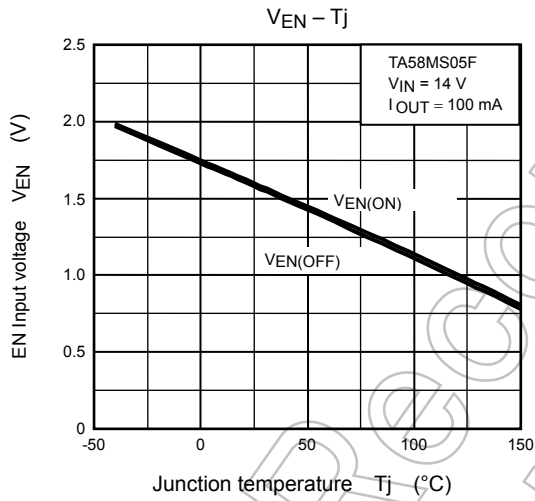
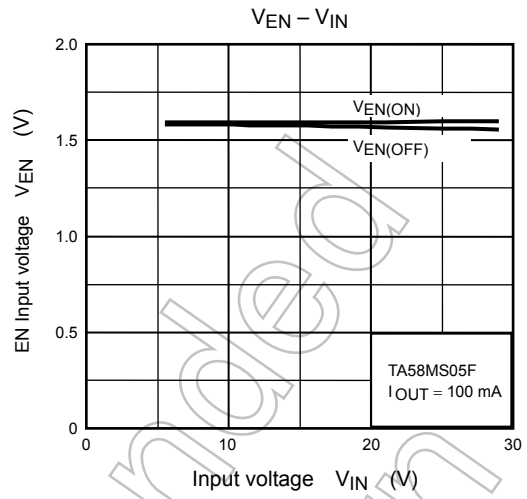
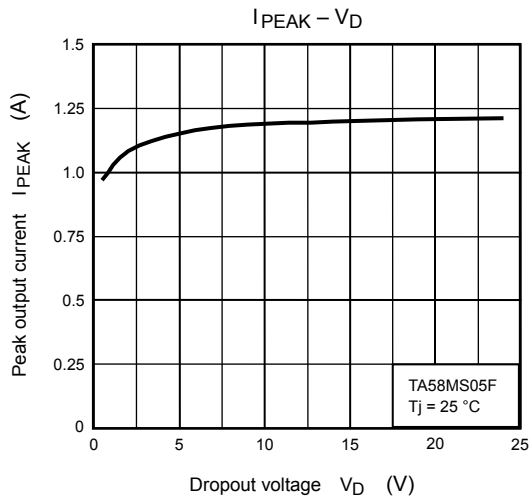

Not Recommended for New Design

Package Dimensions

HSIP5-P-1.27B

Unit: mm

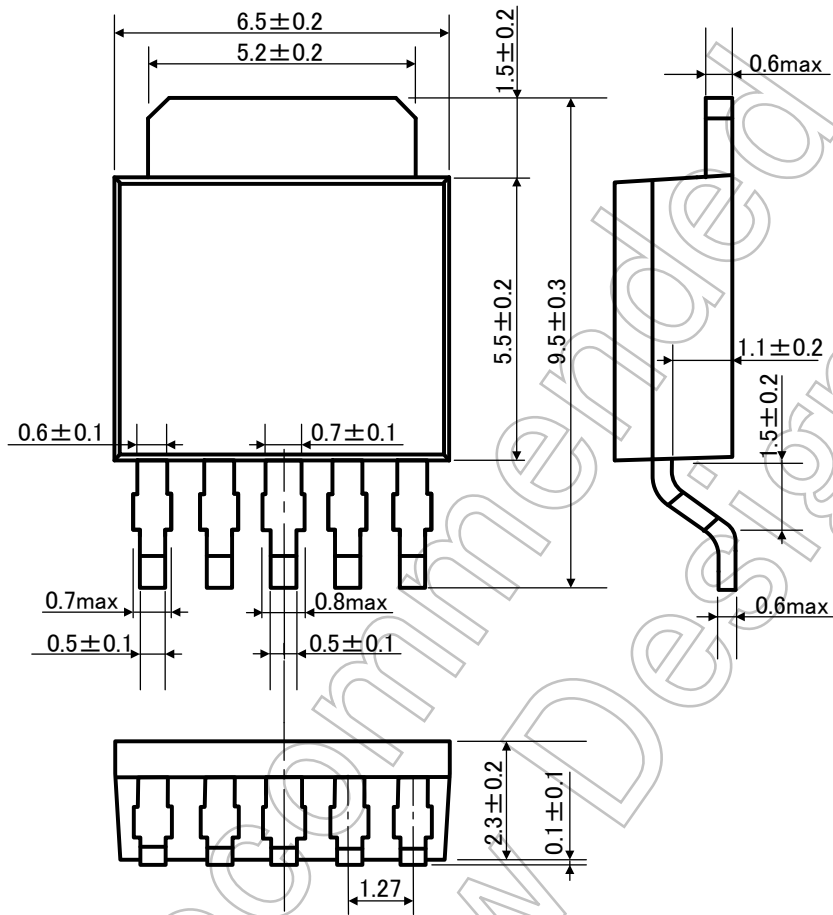

Weight: 0.36 g (Typ.)

RESTRICTIONS ON PRODUCT USE

- Toshiba Corporation, and its subsidiaries and affiliates (collectively "TOSHIBA"), reserve the right to make changes to the information in this document, and related hardware, software and systems (collectively "Product") without notice.
- This document and any information herein may not be reproduced without prior written permission from TOSHIBA. Even with TOSHIBA's written permission, reproduction is permissible only if reproduction is without alteration/omission.
- Though TOSHIBA works continually to improve Product's quality and reliability, Product can malfunction or fail. Customers are responsible for complying with safety standards and for providing adequate designs and safeguards for their hardware, software and systems which minimize risk and avoid situations in which a malfunction or failure of Product could cause loss of human life, bodily injury or damage to property, including data loss or corruption. Before customers use the Product, create designs including the Product, or incorporate the Product into their own applications, customers must also refer to and comply with (a) the latest versions of all relevant TOSHIBA information, including without limitation, this document, the specifications, the data sheets and application notes for Product and the precautions and conditions set forth in the "TOSHIBA Semiconductor Reliability Handbook" and (b) the instructions for the application with which the Product will be used with or for. Customers are solely responsible for all aspects of their own product design or applications, including but not limited to (a) determining the appropriateness of the use of this Product in such design or applications; (b) evaluating and determining the applicability of any information contained in this document, or in charts, diagrams, programs, algorithms, sample application circuits, or any other referenced documents; and (c) validating all operating parameters for such designs and applications. **TOSHIBA ASSUMES NO LIABILITY FOR CUSTOMERS' PRODUCT DESIGN OR APPLICATIONS.**
- **PRODUCT IS NEITHER INTENDED NOR WARRANTED FOR USE IN EQUIPMENTS OR SYSTEMS THAT REQUIRE EXTRAORDINARILY HIGH LEVELS OF QUALITY AND/OR RELIABILITY, AND/OR A MALFUNCTION OR FAILURE OF WHICH MAY CAUSE LOSS OF HUMAN LIFE, BODILY INJURY, SERIOUS PROPERTY DAMAGE AND/OR SERIOUS PUBLIC IMPACT ("UNINTENDED USE").** Except for specific applications as expressly stated in this document, Unintended Use includes, without limitation, equipment used in nuclear facilities, equipment used in the aerospace industry, medical equipment, equipment used for automobiles, trains, ships and other transportation, traffic signaling equipment, equipment used to control combustions or explosions, safety devices, elevators and escalators, devices related to electric power, and equipment used in finance-related fields. **IF YOU USE PRODUCT FOR UNINTENDED USE, TOSHIBA ASSUMES NO LIABILITY FOR PRODUCT.** For details, please contact your TOSHIBA sales representative.
- Do not disassemble, analyze, reverse-engineer, alter, modify, translate or copy Product, whether in whole or in part.
- Product shall not be used for or incorporated into any products or systems whose manufacture, use, or sale is prohibited under any applicable laws or regulations.
- The information contained herein is presented only as guidance for Product use. No responsibility is assumed by TOSHIBA for any infringement of patents or any other intellectual property rights of third parties that may result from the use of Product. No license to any intellectual property right is granted by this document, whether express or implied, by estoppel or otherwise.
- **ABSENT A WRITTEN SIGNED AGREEMENT, EXCEPT AS PROVIDED IN THE RELEVANT TERMS AND CONDITIONS OF SALE FOR PRODUCT, AND TO THE MAXIMUM EXTENT ALLOWABLE BY LAW, TOSHIBA (1) ASSUMES NO LIABILITY WHATSOEVER, INCLUDING WITHOUT LIMITATION, INDIRECT, CONSEQUENTIAL, SPECIAL, OR INCIDENTAL DAMAGES OR LOSS, INCLUDING WITHOUT LIMITATION, LOSS OF PROFITS, LOSS OF OPPORTUNITIES, BUSINESS INTERRUPTION AND LOSS OF DATA, AND (2) DISCLAIMS ANY AND ALL EXPRESS OR IMPLIED WARRANTIES AND CONDITIONS RELATED TO SALE, USE OF PRODUCT, OR INFORMATION, INCLUDING WARRANTIES OR CONDITIONS OF MERCHANTABILITY, FITNESS FOR A PARTICULAR PURPOSE, ACCURACY OF INFORMATION, OR NONINFRINGEMENT.**
- Do not use or otherwise make available Product or related software or technology for any military purposes, including without limitation, for the design, development, use, stockpiling or manufacturing of nuclear, chemical, or biological weapons or missile technology products (mass destruction weapons). Product and related software and technology may be controlled under the applicable export laws and regulations including, without limitation, the Japanese Foreign Exchange and Foreign Trade Law and the U.S. Export Administration Regulations. Export and re-export of Product or related software or technology are strictly prohibited except in compliance with all applicable export laws and regulations.
- Please contact your TOSHIBA sales representative for details as to environmental matters such as the RoHS compatibility of Product. Please use Product in compliance with all applicable laws and regulations that regulate the inclusion or use of controlled substances, including without limitation, the EU RoHS Directive. **TOSHIBA ASSUMES NO LIABILITY FOR DAMAGES OR LOSSES OCCURRING AS A RESULT OF NONCOMPLIANCE WITH APPLICABLE LAWS AND REGULATIONS.**

X-ON Electronics

Largest Supplier of Electrical and Electronic Components

Click to view similar products for [LDO Voltage Regulators](#) category:

Click to view products by [Toshiba](#) manufacturer:

Other Similar products are found below :

[M38D29FFHP#U1](#) [702103A](#) [717726C](#) [742457H](#) [MP20051DN-LF-Z](#) [R5F111PGGFB#30](#) [AP7363-SP-13](#) [NCP103AMX285TCG](#)
[NCV8664CST33T3G](#) [NCV8752AMX28TCG](#) [L9454](#) [AP7362-HA-7](#) [LX13043CLD](#) [TCR3DF185,LM\(CT](#) [TCR3DF24,LM\(CT](#)
[TCR3DF285,LM\(CT](#) [TCR3DF31,LM\(CT](#) [TCR3DF45,LM\(CT](#) [TLF4949EJ](#) [L9708](#) [L970813TR](#) [030014BB](#) [059985X](#) [EAN61387601](#)
[EAN61573601](#) [NCP121AMX173TCG](#) [NCP4687DH15T1G](#) [NCV8703MX30TCG](#) [701326R](#) [702087BB](#) [755078E](#) [TCR2EN28,LF\(S](#)
[LM1117DT-1.8/NO](#) [LT1086CM#TRPBF](#) [AZ1085S2-1.5TRE1](#) [MAX15101EWL+T](#) [NCV8170AXV250T2G](#) [SCD337BTG](#)
[TCR3DF27,LM\(CT](#) [TCR3DF19,LM\(CT](#) [TCR3DF125,LM\(CT](#) [TCR2EN18,LF\(S](#) [MAX15103EWL+T](#) [TS2937CZ-5.0 C0](#) [MAX8878EUK30-](#)
[T](#) [MAX663CPA](#) [NCV4269CPD50R2G](#) [NCV8716MT30TBG](#) [AZ1117IH-1.2TRG1](#) [MP2013GQ-P](#)