

TOSHIBA Bi-CD Integrated Circuit Silicon Monolithic

TB6559FG

Full-Bridge DC Motor Driver IC

The TB6559FG is a full-bridge DC motor driver with LDMOS output transistors.

It uses P-channel MOSFETs on the high side and N-channel MOSFETs on the low side, eliminating the need for a charge pump. The TB6559FG achieves high thermal efficiency.

Four operating modes are selectable via IN1 and IN2: clockwise (CW), counterclockwise (CCW), short brake and stop.

Features

- Power supply voltage: 50 V (max)
- Output current: 2.5 A (max)
- Low-ON resistance (upper and lower sum): 1.3 Ω (typ.)
- Constant-current or direct PWM
- Standby mode
- Clockwise (CW), counterclockwise (CCW), short brake and stop
- Overcurrent protection
- Thermal shutdown

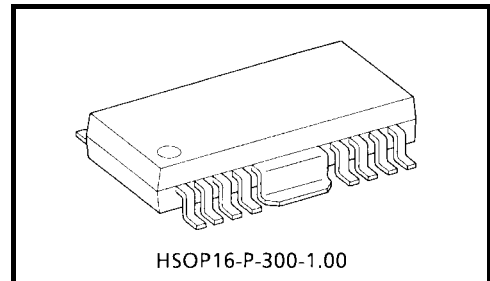

Weight: 0.50 g (typ.)

Block Diagram

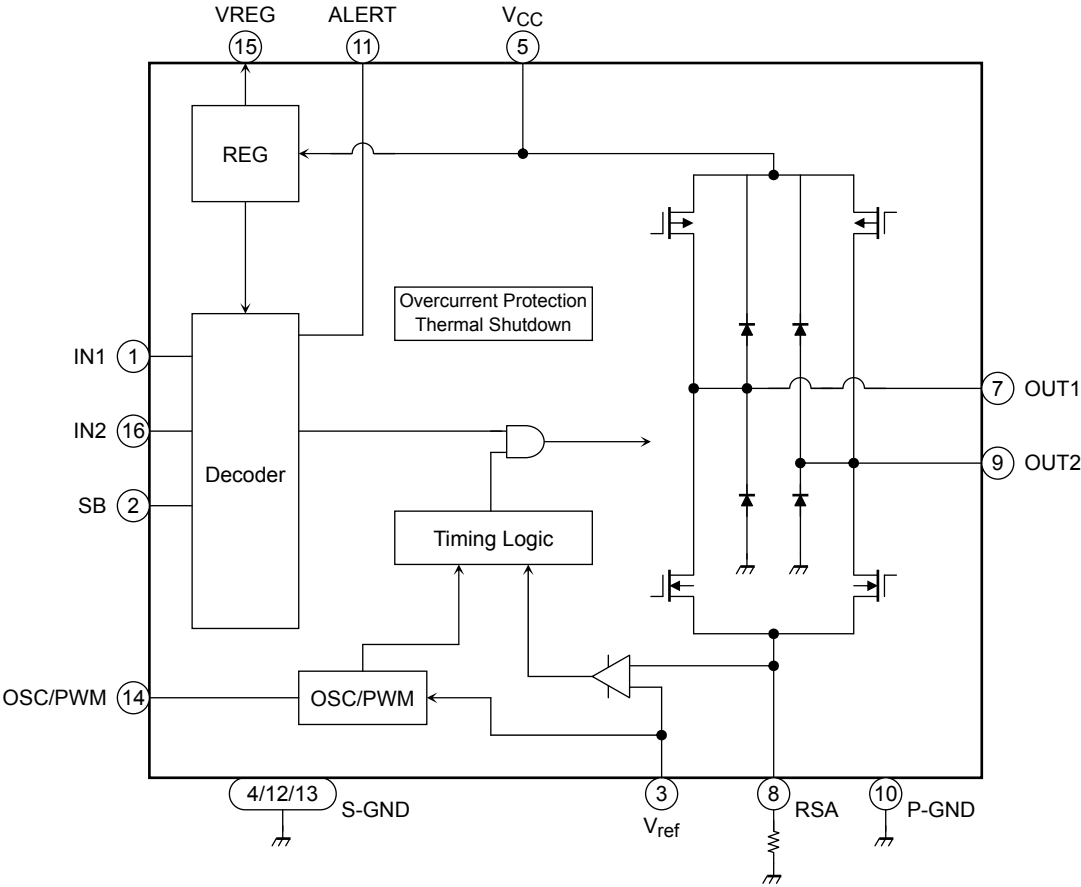

Pin Functions

Pin No	Pin Name	Functional Description	Remarks
1	IN1	Control signal input 1	Apply either a 0-V or 5-V signal.
2	SB	Standby pin	H: Start, L: Standby
3	V _{ref}	Supply voltage pin for current control	0 to 3 V: constant-current control 4.5 to 5.5 V: PWM control
4	S-GND	Ground	—
5	V _{CC}	Power supply pin	V _{CC (ope)} = 10 to 30 V
6	(NC)	No connection	—
7	OUT1	Output pin 1	Connect OUT1 to a motor coil pin.
8	RSA	Connection pin for an output current detection resistor	—
9	OUT2	Output pin 2	Connect OUT2 to a motor coil pin.
10	P-GND	Power ground	—
11	ALERT	Protective operation alert output	5 V: Protective operation 0 V: Normal
12	S-GND	Ground	—
13	S-GND	Ground	—
14	OSC/PWM	Connection pin for an external capacitor/PWM input	V _{ref} = 0 to 3 V: Connect a capacitor for oscillation V _{ref} = 4.5 to 5.5 V: Input PWM signal
15	VREG	5-V output pin	Connect a capacitor between VREG and S-GND.
16	IN2	Control signal input 2	Apply either a 0-V or 5-V signal.
Fin	Fin	Ground	Connect Fin to S-GND

Absolute Maximum Ratings (T_a = 25°C)

Characteristics	Symbol	Rating	Unit
Supply voltage	V _{CC}	50	V
Output current	I _O (Peak)	2.5 (Note 1)	A
	I _O (Ave)	1.0	
Power dissipation	P _D	1.4 (Note 2)	W
Operating temperature	T _{opr}	-30 to 85	°C
Storage temperature	T _{stg}	-55 to 150	°C

Note 1: The absolute maximum ratings are the limits that must not be exceeded, even for an instant, under worst possible conditions.

Note 2: Measured on a 60 mm × 30 mm × 1.6 mm PCB with a 50% dissipating copper surface.

Operating Ranges (T_a = 25°C)

Characteristics	Symbol	Rating	Unit
Supply voltage	V _{CC}	10 to 30	V
PWM frequency	f _{CLK}	up to 100	kHz
OSC frequency	f _{OSC}	up to 500	kHz
VREG output current	VREGout	up to 1	mA

Electrical Characteristics (V_{CC} = 24 V, T_a = 25°C, unless otherwise specified)

Characteristics		Symbol	Test Condition	Min	Typ.	Max	Unit	
Supply current		I _{CC1}	Stop mode	—	4	8	mA	
		I _{CC2}	CW and CCW modes	—	4	8		
		I _{CC3}	Short brake mode	—	4	8		
		I _{CC4}	Standby mode	—	1	2		
Control circuit		Input voltage	V _{INH}	—	2	—	5.5	V
			V _{INL}	—	-0.2	—		
		Hysteresis voltage	V _{IN (HYS)}	(Design target only. Not tested in production.)	—	0.1	—	
		Input current	I _{INH}	V _{IN} = 5 V	—	50	75	μA
			I _{INL}	V _{IN} = 0 V	—	—	2	
OSC/PWM input circuit		Input voltage	V _{PWMH}	—	2	—	V _{REG}	V
			V _{PWML}	—	-0.2	—		
		Hysteresis voltage	V _{PWM(HYS)}	(Design target only. Not tested in production.)	—	0.5	—	
		Input current	I _{PWMH}	V _{PWM} = 5 V	—	55	75	μA
			I _{PWML}	V _{PWM} = 0 V	—	—	2	
		PWM frequency	f _{PWM}	Duty cycle = 50%	—	—	100	kHz
Minimum clock pulse width	t _{w(PWM)}	—	2	—	—	μs		
Standby circuit		Input voltage	V _{INSH}	—	2	—	5.5	V
			V _{INSL}	—	-0.2	—		
		Hysteresis voltage	V _{IN (HYS)}	(Design target only. Not tested in production.)	—	0.1	—	
		Input current	I _{INSH}	V _{IN} = 5 V	—	50	75	μA
			I _{INSL}	V _{IN} = 0 V	—	—	2	
V _{ref} input circuit		Constant current control	V _{OSC}	—	0	—	3.0	V
		PWM control	V _{PWM}	—	4.5	—		
		Input current	I _{ref}	I _{IN} = V _{REG}	—	1	3	μA
Output ON-resistance		R _{on (U + L)}	I _O = 0.2 A	—	1.3	1.8	Ω	
			I _O = 1.5 A	—	1.3	1.8		
Output leakage current		I _{L (U)}	V _{CC} = 30 V	—	0.1	10	μA	
		I _{L (L)}	V _{CC} = 30 V	—	0.1	10		
Diode forward voltage		V _{F (U)}	I _O = 1.5 A	—	1.3	1.7	V	
		V _{F (L)}	I _O = 1.5 A	—	1.3	1.7		
Internal reference voltage		V _{REG}	V _{REGout} = 1 mA	4.5	5	5.5	V	
Thermal shutdown temperature		T _{SD}	(Design target only. Not tested in production.)	—	160	—	°C	
Thermal shutdown hysteresis		ΔT _{SD}	(Design target only. Not tested in production.)	—	40	—	°C	
OSC frequency		Charge current	I _{OSC(+)}	V _{OSC/PWM} = 1.5 V (source current)	-1.05	—	-0.65	mA
		Discharge current	I _{OSC(-)}	V _{OSC/PWM} = 3.2 V (sink current)	3.8	—	6.0	
ALERT voltage		V _{ALERT(H)}	I _{ALERT} = -1 mA	V _{REG} - 1	—	—	V	
		V _{ALERT(L)}	I _{ALERT} = 1 mA	—	—	0.5		

Functional Descriptions

Control Input Pins

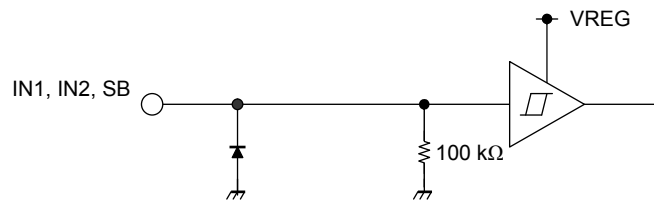

*The circuit diagram is simplified for description.

- The input voltage ranges of the IN1, IN2, OSC/PWM and SB inputs must be as follows. These inputs are CMOS- and TTL-compatible, and have a hysteresis of 0.2 V (typ.).
 V_{INH} : 2 to 5.5 V
 V_{INL} : GND to 0.8 V
- The PWM input frequency should be 100 kHz or less.
- In Standby mode, all circuits are turned off, except the standby and 5-V circuits.
- To bring the device out of Standby mode, IN1 and IN2 must be set Low once (Stop mode); for an operating mode must be selected after the power supply becomes stable.

OSC/PWM Input Pin

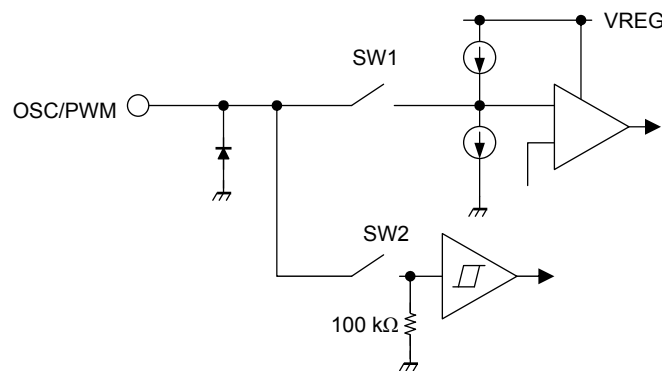



*The circuit diagram is simplified for description.

Either constant-current or direct PWM is selectable according to the voltage of the V_{ref} input (See the “Pin Functions” table). SW1 and SW2 in the above diagram are controlled by the V_{ref} voltage.

- **Constant current PWM**
 For constant-current PWM, V_{ref} must be between 0 V and 3 V (SW1: ON, SW2: OFF) and a capacitor must be connected between OSC/PWM and ground.
- **Direct PWM**
 For direct PWM, V_{ref} must be between 4.5 V and 5.5 V (SW1: OFF, SW2: ON).
 When a PWM signal with an amplitude between 0 V and 5 V is applied to the OSC/PWM input, the OUT1 and OUT2 levels change accordingly, resulting in an alternating sequence of CW/CCW and short brake.

Input/Output Functions

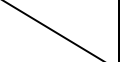
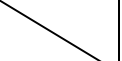
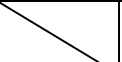
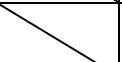
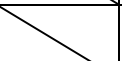
	Input					Output			
	V _{ref}	IN1	IN2	SB	PWM/OSC	I _O (100%) (typ.)	OUT1	OUT2	Mode
OSC	0 to 3 V	H	H	H	Capacitor	—	L	L	Short brake
		L	H	H	Capacitor	$\frac{V_{ref}}{6 \cdot RSA}$	L L	Constant-current chopping 	CCW Short brake
		H	L	H	Capacitor	$\frac{V_{ref}}{6 \cdot RSA}$	Constant-current chopping 	L L	CW Short brake
		L	L	H	Capacitor	—	OFF (Hi-Z)		Stop
		X	X	L	Capacitor	—	OFF (Hi-Z)		Standby
PWM	4.5 to 5.5 V	H	H	H	H L		L	L	Short brake
		L	H	H	H L		L L	H L	CCW Short brake
		H	L	H	H L		H L	L L	CW Short brake
		L	L	H	H L		OFF (Hi-Z)		Stop
		X	X	L	H L		OFF (Hi-Z)		Standby

Note: X = Don't care

Output Operation

- Control mode selection

Either constant-current or direct PWM control can be selected by the V_{ref} input voltage as follows:

Constant-current PWM control: $V_{ref} = 0$ to 3 V

Direct PWM control: $V_{ref} = 4.5$ to 5.5 V

The constant-current feature is disabled in direct PWM mode.

In either mode, the motor operating mode changes between CW/CCW and short brake alternately.

To eliminate shoot-through current that flows from supply to ground due to the simultaneous conduction of high-side and low-side transistors in the bridge output, a dead time of 300 ns (design target only) is generated in the IC when transistors switch from on to off, or vice versa.

The shoot-through protection permits a synchronous rectification PWM operation without controlling the dead time externally. A dead time is also provided internally when the motor operation mode switches between CW and CCW, and between CW (CCW) and short brake, thereby eliminating the need for external dead time insertion.

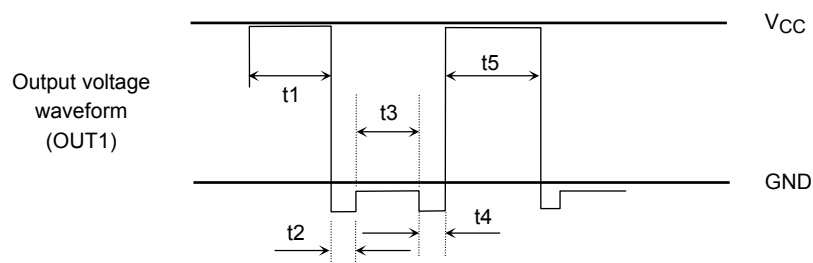
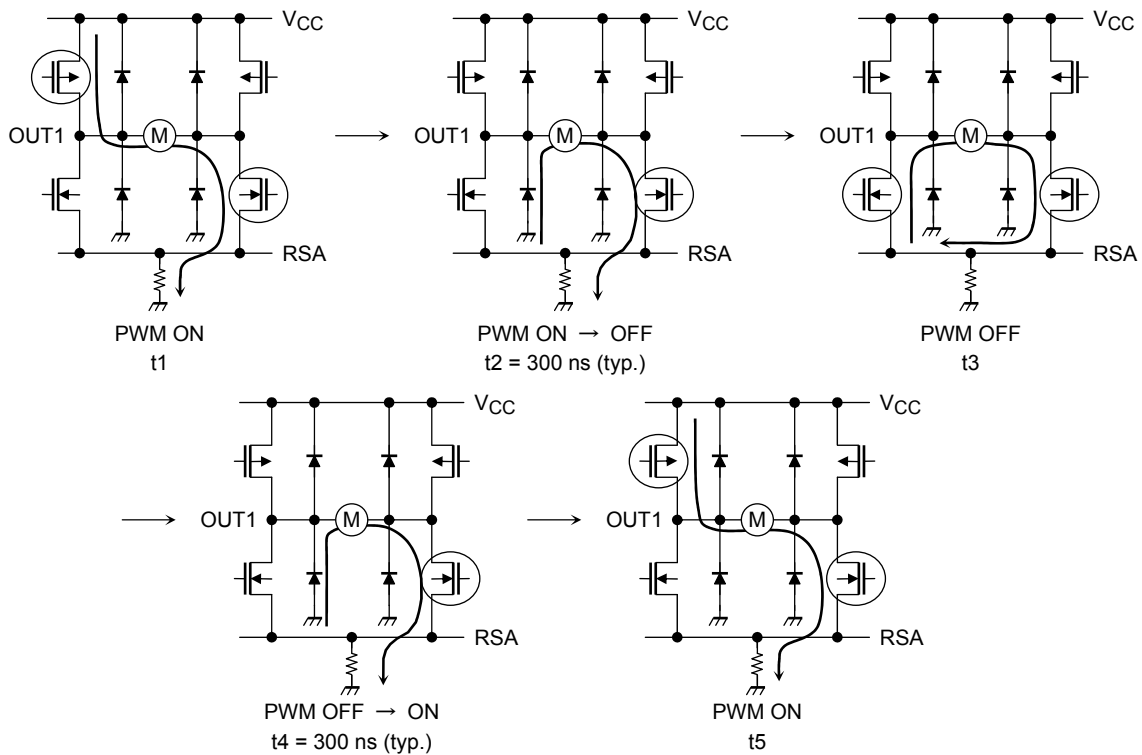

Constant-Current Regulation

When the V_{ref} voltage is kept constant, the constant current regulator keeps the output current constant by using a peak current detection technique.

(1) Constant-current chopping

When V_{RSA} reaches the reference voltage (V_{ref}), the regulator enters Discharge mode.

After four cycles of CK, an internal clock generated by OSC, the regulator moves from Discharge mode to Charge mode.

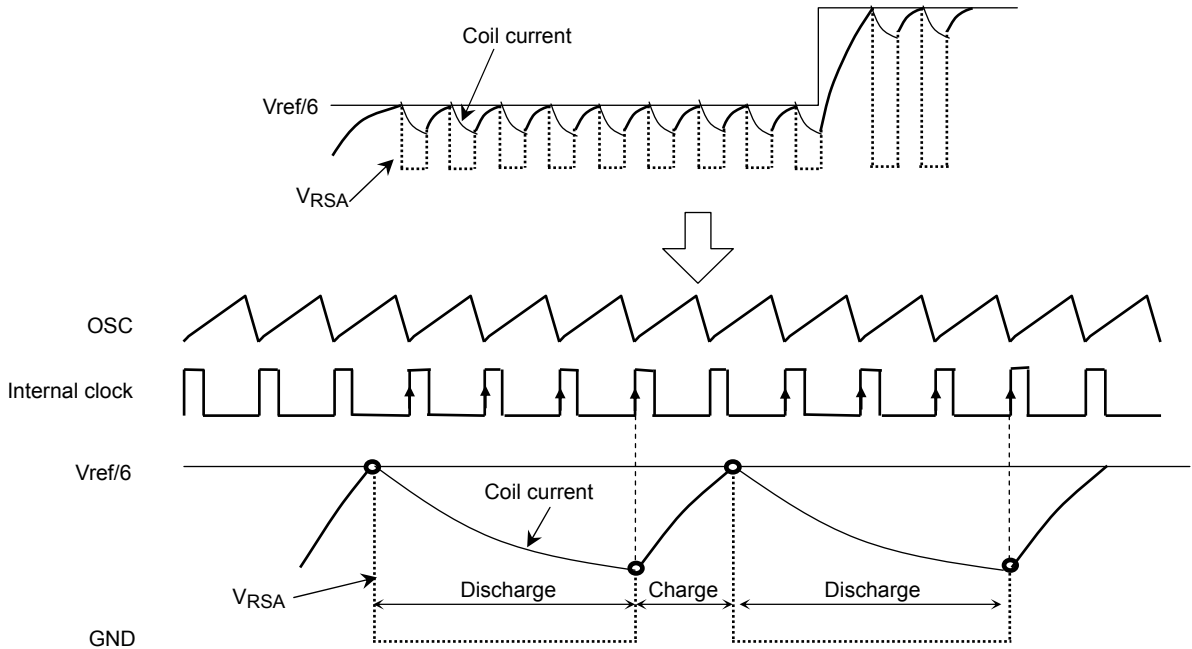

(2) Changing the predefined current (during deceleration)

When V_{RSA} reaches the reference voltage ($V_{ref}/6$), the regulator enters Discharge mode. Four CK cycles later, the regulator exits Discharge mode and enters Charge mode. If $V_{RSA} > V_{ref}/6$ when it enters Charge mode, however, it then reenters Discharge mode. Four CK cycles later, V_{RSA} is again compared against $V_{ref}/6$. If $V_{RSA} < V_{ref}/6$, the regulator enters and remains in Charge mode until V_{RSA} reaches $V_{ref}/6$.

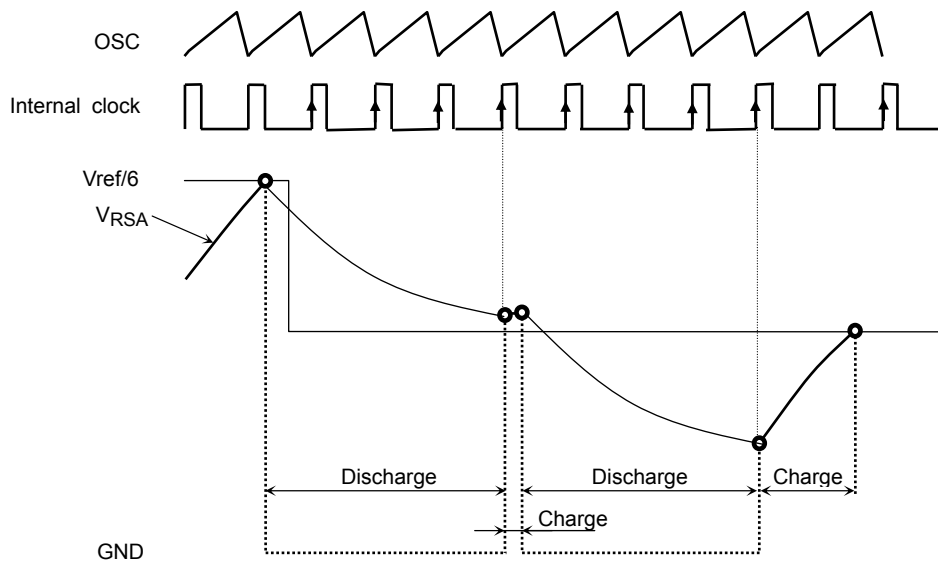

- (3) Changing the predefined current (during acceleration)
 Even when the reference voltage is increased, the regulator remains in Discharge mode for four CK cycles and then it enters Charge mode.

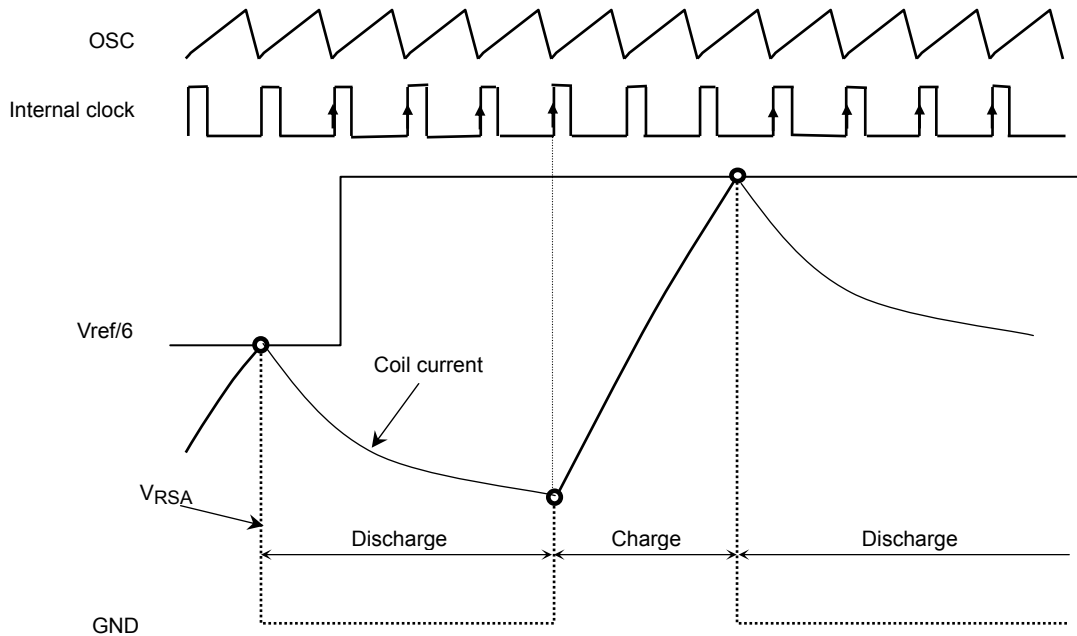

The average current value becomes lower than the set current value because of the peak current detection method. It should be noted that the average current value changes, depending on the motor characteristics.

Calculation of the Internal Oscillation Frequency

The OSC oscillation frequency can be approximated by the following equation:
 $f_{OSC} [Hz] = (0.445 \times 10^{-3}) / C_{OSC} [F]$

Reference Voltage Generator

In constant-current mode, the peak current is determined by the Vref voltage, as follows:

$$I_O = V_{ref}/R_{SA} \times 1/6 [A]$$

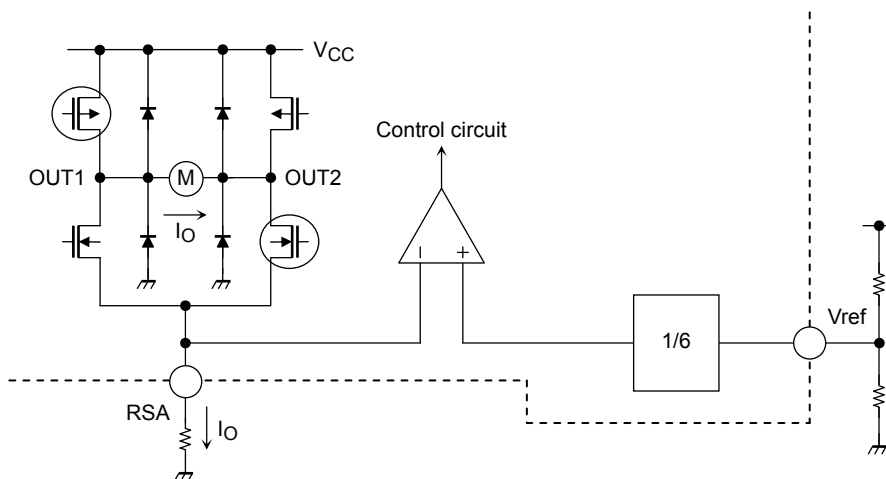

Internal Constant-Voltage (5 V) Circuit

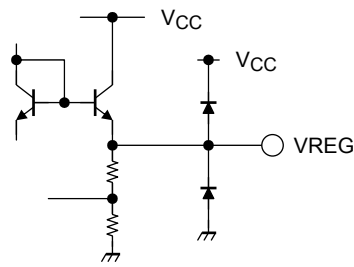

- The TB6559FG includes a 5-V power supply for control circuit biasing.
- For oscillation prevention, a capacitor should be connected between VREG and S-GND. Although VRGE can be used to control the inputs to the TB6559FG, the maximum load current should be limited to 1 mA.
- The TB6559FG has power monitoring circuitry that turns off the output when VREG falls below 6.0 V (design target only). With a hysteresis of 0.3 V (design target only), the output is turned back on when VREG reaches 6.3 V (design target only) again.

Output Circuit

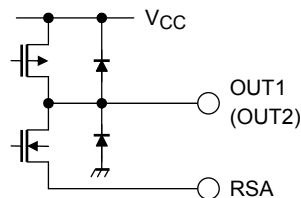

- The TB6559FG uses P-channel MOS transistors on the high side and N-channel MOS transistors on the low side.
- The output ON-resistance (R_{on}) is 1.3 Ω (high-side and low-side sum)
- The switching characteristics of the output transistors are shown below.

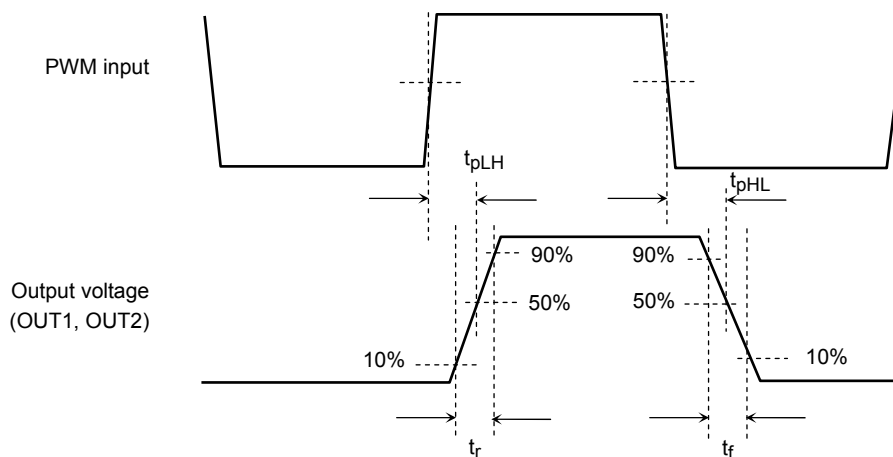

Switching Characteristics

Item	Typical Value	Unit
t_{pLH}	750	ns
t_{pHL}	1000	
t_r	100	
t_f	150	
Dead time	700	

VCC Power Supply

- VCC supplies a voltage to the output circuit and the internal 5-V circuit.
- The operating voltage range is:
 $V_{CC (opr.)} = 10 \text{ to } 30 \text{ V}$
- IN1, IN2, and SB should be set Low at power-on. (In direct PWM mode, OSC/PWM should also be set Low.)

GND Section

- The TB6559FG has two separate grounds: S-GND for the control circuitry and P-GND for the output circuitry. S-GND and P-GND should be short-circuited at a location as close to the TB6559FG as possible.

ALERT Circuit

- When either the thermal shutdown or overcurrent protection circuit is activated, the ALERT output goes High (CMOS output). When the ALERT pin is changed from low to high or vice versa, its output signal may become unstable, causing chattering or noise pulses. To avoid such instability, it is recommended to insert an RC filter to the output line.

Normal operation: Low

Protective operation: High

Thermal Shutdown (TSD) Circuit

The TB6559FG incorporates a thermal shutdown circuit. When the junction temperature (T_j) exceeds 160°C (typ.), the output transistors are turned off.

The output transistors are automatically turned on when the junction temperature cools past the shutdown threshold, which is lowered by a hysteresis of 40°C .

The IC has 40°C of temperature hysteresis.

$T_{SD} = 160^\circ\text{C}$ (design target only)

$\Delta T_{SD} = 40^\circ\text{C}$ (design target only)

<Thermal Shutdown>

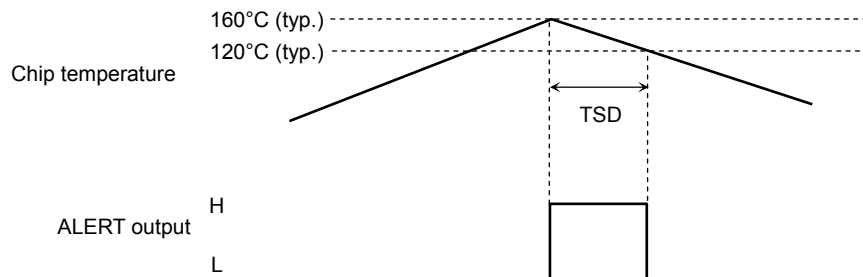

Overcurrent Protection Circuit (ISD)

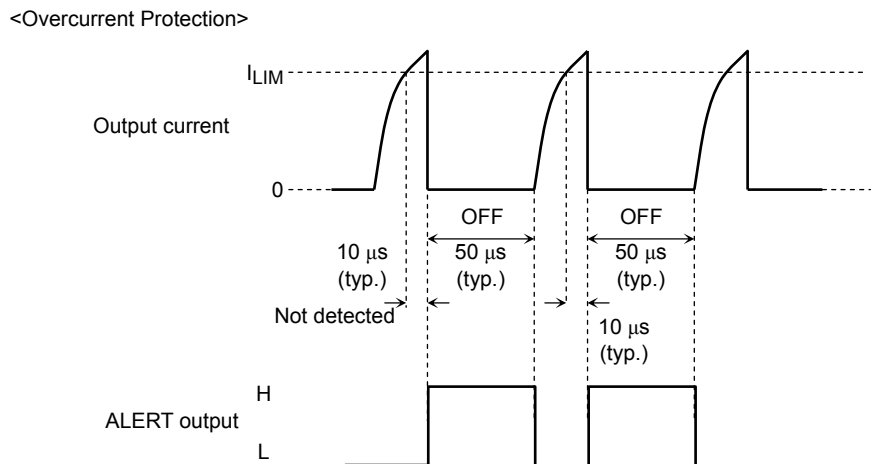

The TB6559FG allows for the sensing of the current that flows through each output transistor.

The currents through each of the output transistors are continually monitored. In the event of an overcurrent in at least one of the transistors, the overcurrent protection circuitry turns all transistors off.

The overcurrent protection circuitry incorporates a timer to measure $50\ \mu s$ (typ.) after the transistors are turned off. After $50\ \mu s$, the protection circuitry turns the output transistors back on again automatically. If the overcurrent persists, the device begins cycling into and out of thermal shutdown. To prevent false detection due to glitches, the overcurrent protection circuitry turns off the transistors only when the current exceeds the shutdown threshold for $10\ \mu s$ or longer.

The design target only for current limiting is $5\ A$ (typ.) but has variations between 4.0 to $6.0\ A$.

Typical Characteristics Graphs

TB6559FG

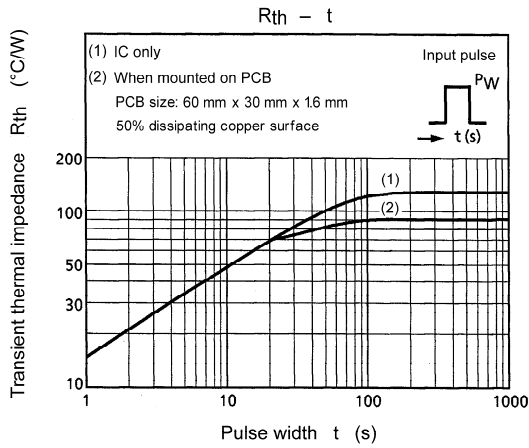

TB6559FG

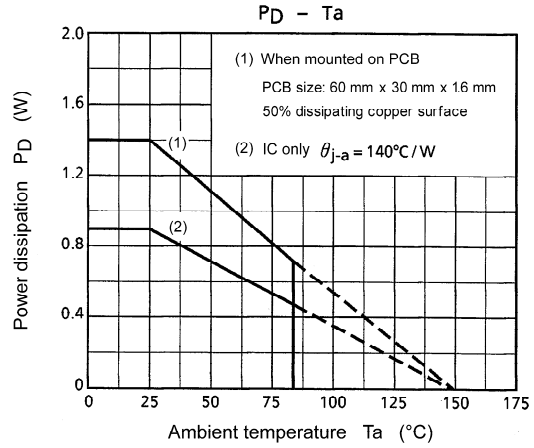

External Components

Symbol	Use	Recommended Value	Remarks
C ₁	VREG oscillation prevention	0.1 μF to 1.0 μF	—
C ₂	Power noise absorption	0.001 μF to 1 μF	—
C ₃	Power noise absorption	50 μF to 100 μF	—

Typical Application Examples

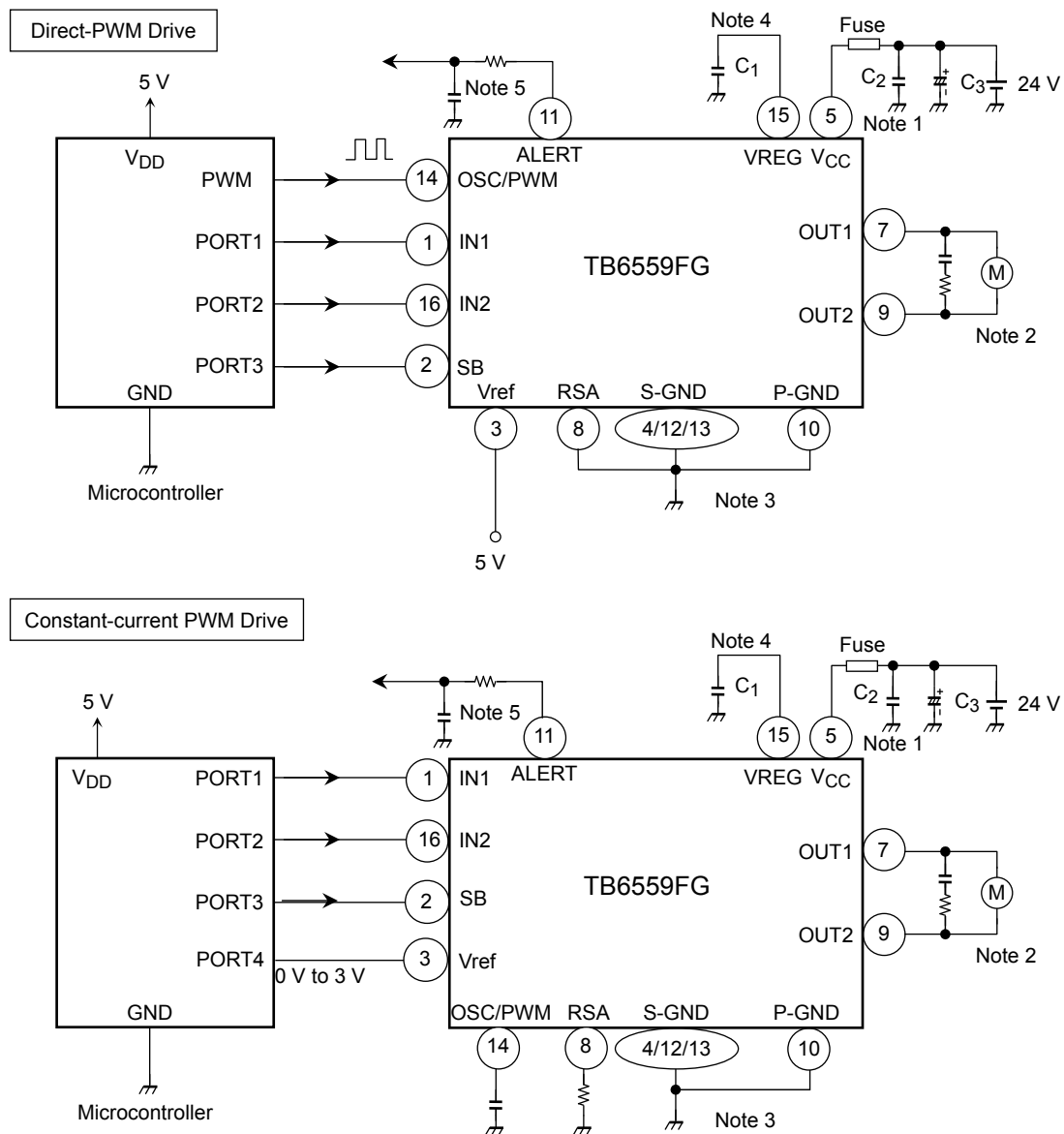

Note 1: A bypass capacitor should be connected between V_{CC} and P-GND and placed as close as possible to the TB6559FG.

Note 2: When a capacitor is connected between the motor pins to reduce noise, a resistor should also be inserted to limit the charge current. This capacitor causes the switching loss to increase for PWM control; therefore, this capacitor should not be used, if possible.

Note 3: S-GND and P-GND should be short-circuited at a location as close to the TB6559FG as possible. (Same for Fin)

Note 4: The capacitor C_1 should be connected to S-GND.

Note 5: If there is chattering or noise in the output signal, connect an RC filter to ALERT.

Usage Precautions

- Although the TB6559FG contains overcurrent detection circuitry, a large current might abruptly flow through the IC in case of a short-circuit to power supply, a short-circuit to ground or a short-circuit across the load, damaging the device permanently. This possibility should be fully considered in the design of the output, VCC and ground lines. If the device is damaged, a large current might continually flow through the device as a secondary effect. Therefore, Toshiba recommends that a fuse be connected to the power supply line.
- Install this IC properly. If not, (e.g., installing it in the wrong position), the IC might be broken.
- If external components are shorted together, the IC might be broken.

Package Dimensions

HSOP16-P-300-1.00

Unit : mm

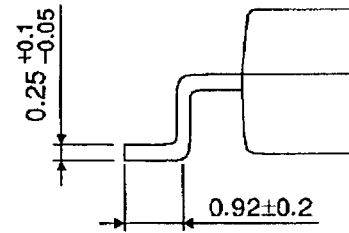
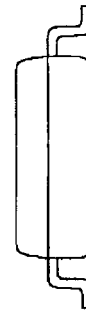
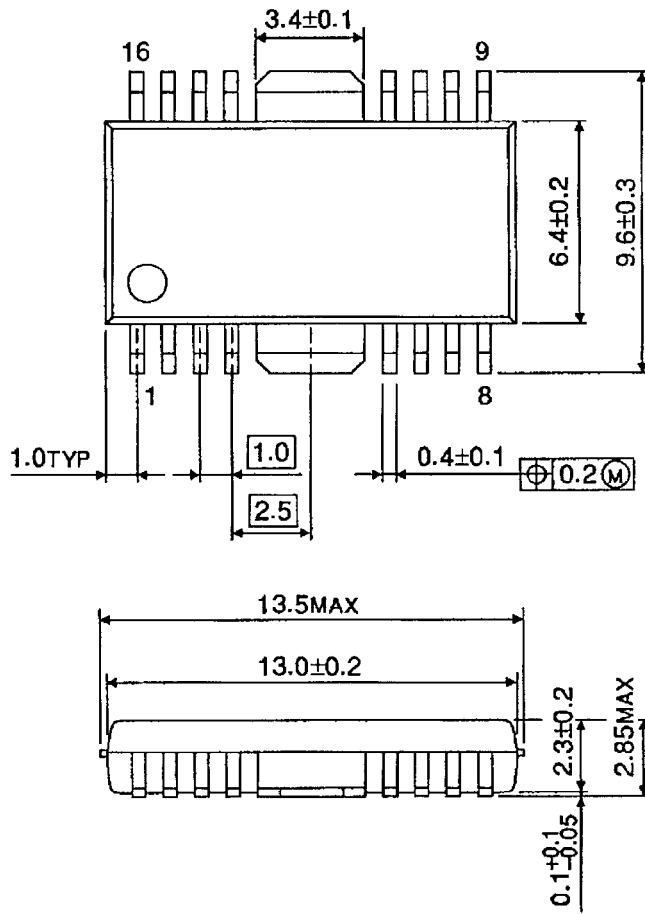

Weight: 0.50 g (typ.)

Notes on Contents

1. Block Diagrams

Some of the functional blocks, circuits, or constants in the block diagram may be omitted or simplified for explanatory purposes.

2. Equivalent Circuits

The equivalent circuit diagrams may be simplified or some parts of them may be omitted for explanatory purposes.

3. Timing Charts

Timing charts may be simplified for explanatory purposes.

4. Application Circuits

The application circuits shown in this document are provided for reference purposes only. Thorough evaluation is required, especially at the mass production design stage.

Toshiba does not grant any license to any industrial property rights by providing these examples of application circuits.

5. Test Circuits

Components in the test circuits are used only to obtain and confirm the device characteristics. These components and circuits are not guaranteed to prevent malfunction or failure from occurring in the application equipment.

IC Usage Considerations

Notes on Handling of ICs

- (1) The absolute maximum ratings of a semiconductor device are a set of ratings that must not be exceeded, even for a moment. Do not exceed any of these ratings.
Exceeding the rating(s) may cause the device breakdown, damage or deterioration, and may result injury by explosion or combustion.
- (2) Use an appropriate power supply fuse to ensure that a large current does not continuously flow in case of over current and/or IC failure. The IC will fully break down when used under conditions that exceed its absolute maximum ratings, when the wiring is routed improperly or when an abnormal pulse noise occurs from the wiring or load, causing a large current to continuously flow and the breakdown can lead smoke or ignition. To minimize the effects of the flow of a large current in case of breakdown, appropriate settings, such as fuse capacity, fusing time and insertion circuit location, are required.
- (3) If your design includes an inductive load such as a motor coil, incorporate a protection circuit into the design to prevent device malfunction or breakdown caused by the current resulting from the inrush current at power ON or the negative current resulting from the back electromotive force at power OFF. IC breakdown may cause injury, smoke or ignition.
Use a stable power supply with ICs with built-in protection functions. If the power supply is unstable, the protection function may not operate, causing IC breakdown. IC breakdown may cause injury, smoke or ignition.
- (4) Do not insert devices in the wrong orientation or incorrectly.
Make sure that the positive and negative terminals of power supplies are connected properly. Otherwise, the current or power consumption may exceed the absolute maximum rating, and exceeding the rating(s) may cause the device breakdown, damage or deterioration, and may result injury by explosion or combustion.
In addition, do not use any device that is applied the current with inserting in the wrong orientation or incorrectly even just one time.

Points to Remember on Handling of ICs

- (1) **Over Current Protection Circuit**

Over current protection circuits (referred to as current limiter circuits) do not necessarily protect ICs under all circumstances. If the Over current protection circuits operate against the over current, clear the over current status immediately.

Depending on the method of use and usage conditions, such as exceeding absolute maximum ratings can cause the over current protection circuit to not operate properly or IC breakdown before operation. In addition, depending on the method of use and usage conditions, if over current continues to flow for a long time after operation, the IC may generate heat resulting in breakdown.
- (2) **Thermal Shutdown Circuit**

Thermal shutdown circuits do not necessarily protect ICs under all circumstances. If the thermal shutdown circuits operate against the over temperature, clear the heat generation status immediately. Depending on the method of use and usage conditions, such as exceeding absolute maximum ratings can cause the thermal shutdown circuit to not operate properly or IC breakdown before operation.
- (3) **Heat Radiation Design**

In using an IC with large current flow such as power amp, regulator or driver, please design the device so that heat is appropriately radiated, not to exceed the specified junction temperature (T_j) at any time and condition. These ICs generate heat even during normal use. An inadequate IC heat radiation design can lead to decrease in IC life, deterioration of IC characteristics or IC breakdown. In addition, please design the device taking into consideration the effect of IC heat radiation with peripheral components.
- (4) **Back-EMF**

When a motor rotates in the reverse direction, stops or slows down abruptly, a current flow back to the motor's power supply due to the effect of back-EMF. If the current sink capability of the power supply is small, the device's motor power supply and output pins might be exposed to conditions beyond absolute maximum ratings. To avoid this problem, take the effect of back-EMF into consideration in system design.

RESTRICTIONS ON PRODUCT USE

- Toshiba Corporation, and its subsidiaries and affiliates (collectively "TOSHIBA"), reserve the right to make changes to the information in this document, and related hardware, software and systems (collectively "Product") without notice.
- This document and any information herein may not be reproduced without prior written permission from TOSHIBA. Even with TOSHIBA's written permission, reproduction is permissible only if reproduction is without alteration/omission.
- Though TOSHIBA works continually to improve Product's quality and reliability, Product can malfunction or fail. Customers are responsible for complying with safety standards and for providing adequate designs and safeguards for their hardware, software and systems which minimize risk and avoid situations in which a malfunction or failure of Product could cause loss of human life, bodily injury or damage to property, including data loss or corruption. Before customers use the Product, create designs including the Product, or incorporate the Product into their own applications, customers must also refer to and comply with (a) the latest versions of all relevant TOSHIBA information, including without limitation, this document, the specifications, the data sheets and application notes for Product and the precautions and conditions set forth in the "TOSHIBA Semiconductor Reliability Handbook" and (b) the instructions for the application with which the Product will be used with or for. Customers are solely responsible for all aspects of their own product design or applications, including but not limited to (a) determining the appropriateness of the use of this Product in such design or applications; (b) evaluating and determining the applicability of any information contained in this document, or in charts, diagrams, programs, algorithms, sample application circuits, or any other referenced documents; and (c) validating all operating parameters for such designs and applications. **TOSHIBA ASSUMES NO LIABILITY FOR CUSTOMERS' PRODUCT DESIGN OR APPLICATIONS.**
- **PRODUCT IS NEITHER INTENDED NOR WARRANTED FOR USE IN EQUIPMENTS OR SYSTEMS THAT REQUIRE EXTRAORDINARILY HIGH LEVELS OF QUALITY AND/OR RELIABILITY, AND/OR A MALFUNCTION OR FAILURE OF WHICH MAY CAUSE LOSS OF HUMAN LIFE, BODILY INJURY, SERIOUS PROPERTY DAMAGE AND/OR SERIOUS PUBLIC IMPACT ("UNINTENDED USE").** Except for specific applications as expressly stated in this document, Unintended Use includes, without limitation, equipment used in nuclear facilities, equipment used in the aerospace industry, medical equipment, equipment used for automobiles, trains, ships and other transportation, traffic signaling equipment, equipment used to control combustions or explosions, safety devices, elevators and escalators, devices related to electric power, and equipment used in finance-related fields. **IF YOU USE PRODUCT FOR UNINTENDED USE, TOSHIBA ASSUMES NO LIABILITY FOR PRODUCT.** For details, please contact your TOSHIBA sales representative.
- Do not disassemble, analyze, reverse-engineer, alter, modify, translate or copy Product, whether in whole or in part.
- Product shall not be used for or incorporated into any products or systems whose manufacture, use, or sale is prohibited under any applicable laws or regulations.
- The information contained herein is presented only as guidance for Product use. No responsibility is assumed by TOSHIBA for any infringement of patents or any other intellectual property rights of third parties that may result from the use of Product. No license to any intellectual property right is granted by this document, whether express or implied, by estoppel or otherwise.
- **ABSENT A WRITTEN SIGNED AGREEMENT, EXCEPT AS PROVIDED IN THE RELEVANT TERMS AND CONDITIONS OF SALE FOR PRODUCT, AND TO THE MAXIMUM EXTENT ALLOWABLE BY LAW, TOSHIBA (1) ASSUMES NO LIABILITY WHATSOEVER, INCLUDING WITHOUT LIMITATION, INDIRECT, CONSEQUENTIAL, SPECIAL, OR INCIDENTAL DAMAGES OR LOSS, INCLUDING WITHOUT LIMITATION, LOSS OF PROFITS, LOSS OF OPPORTUNITIES, BUSINESS INTERRUPTION AND LOSS OF DATA, AND (2) DISCLAIMS ANY AND ALL EXPRESS OR IMPLIED WARRANTIES AND CONDITIONS RELATED TO SALE, USE OF PRODUCT, OR INFORMATION, INCLUDING WARRANTIES OR CONDITIONS OF MERCHANTABILITY, FITNESS FOR A PARTICULAR PURPOSE, ACCURACY OF INFORMATION, OR NONINFRINGEMENT.**
- Do not use or otherwise make available Product or related software or technology for any military purposes, including without limitation, for the design, development, use, stockpiling or manufacturing of nuclear, chemical, or biological weapons or missile technology products (mass destruction weapons). Product and related software and technology may be controlled under the applicable export laws and regulations including, without limitation, the Japanese Foreign Exchange and Foreign Trade Law and the U.S. Export Administration Regulations. Export and re-export of Product or related software or technology are strictly prohibited except in compliance with all applicable export laws and regulations.
- Please contact your TOSHIBA sales representative for details as to environmental matters such as the RoHS compatibility of Product. Please use Product in compliance with all applicable laws and regulations that regulate the inclusion or use of controlled substances, including without limitation, the EU RoHS Directive. **TOSHIBA ASSUMES NO LIABILITY FOR DAMAGES OR LOSSES OCCURRING AS A RESULT OF NONCOMPLIANCE WITH APPLICABLE LAWS AND REGULATIONS.**

X-ON Electronics

Largest Supplier of Electrical and Electronic Components

Click to view similar products for [Motor/Motion/Ignition Controllers & Drivers](#) category:

Click to view products by [Toshiba](#) manufacturer:

Other Similar products are found below :

[FSB50550TB2](#) [FSBF15CH60BTH](#) [MSVCPM2-63-12](#) [MSVGW45-14-2](#) [MSVGW54-14-3](#) [MSVGW54-14-5](#) [NTE7043](#) [LA6565VR-TLM-E](#)
[LB11650-E](#) [LB1837M-TLM-E](#) [LB1845DAZ-XE](#) [LC898300XA-MH](#) [SS30-TE-L-E](#) [26700](#) [LV8281VR-TLM-H](#) [BA5839FP-E2](#) [IRAM236-1067A](#) [LA6584JA-AH](#) [LB11847L-E](#) [NCV70501DW002R2G](#) [AH293-PL-B](#) [STK672-630CN-E](#) [TND315S-TL-2H](#) [FNA23060](#) [FSB50250AB](#)
[FNA41060](#) [MSVB54](#) [MSVBTC50E](#) [MSVCPM3-54-12](#) [MSVCPM3-63-12](#) [MSVCPM4-63-12](#) [MSVTA120](#) [FSB50550AB](#)
[NCV70501DW002G](#) [LC898301XA-MH](#) [LV8413GP-TE-L-E](#) [MSVGW45-14-3](#) [MSVGW45-14-4](#) [MSVGW45-14-5](#) [MSVGW54-14-4](#)
[STK984-091A-E](#) [MP6519GQ-Z](#) [LB11651-E](#) [IRSM515-025DA4](#) [LV8127T-TLM-H](#) [MC33812EKR2](#) [NCP81382MNTXG](#) [TDA21801](#)
[LB11851FA-BH](#) [NCV70627DQ001R2G](#)